

**New!**

## H SERIES SNAP-IN ROCKER SWITCHES

**B**



### FEATURES

- Higher power load ratings.
- Single and double pole models with smooth action and tactile response.
- Bezels, actuators & lenses available in a wide range of colors.
- Unique double rocker design with integral illumination.
- .248" (6.3mm) solder lug/quick-connect terminals.
- Choice of 125 or 250 volt neon indicator lamp.
- Illuminated and non-illuminated models.

### SPECIFICATIONS

<b>Contact ratings:</b>	16 amps (resistive) at 250VAC, 4 amps inductive at 250VAC
<b>Electrical life:</b>	10,000 operations min. at full load
<b>Mechanical life:</b>	100,000 operations
<b>Maximum working temperature:</b>	+85°C

### MATERIALS

<b>Contacts:</b>	90% silver, 10% cadmium
<b>Terminals:</b>	Silver plated brass
<b>Armature:</b>	Silver plated copper
<b>Actuator:</b>	Polycarbonate or ABS
<b>Body:</b>	Polyester
<b>Bezel:</b>	Polycarbonate
<b>Lens:</b>	Polycarbonate



SINGLE POLE MODEL NO.	DOUBLE POLE MODEL NO.	CIRCUIT
H11CG1R1	H21CG1R1	ON-OFF
H12CG1R1	H22CG1R1	ON-ON

Above models have silk chrome actuator, gun metal bezel, red lens and 125V neon lamp with resistor wired in series (see wiring diagrams). See order guide for other models.

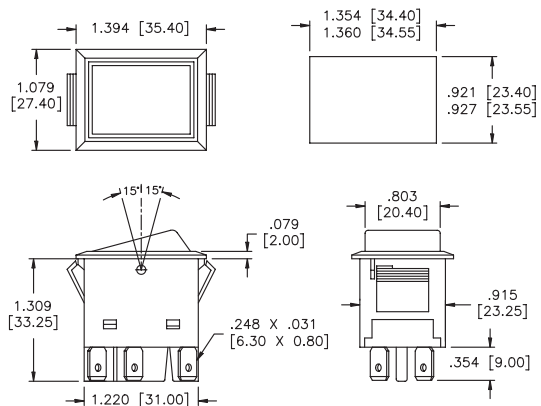

SPECIFICATIONS SUBJECT TO CHANGE WITHOUT NOTICE

**New!**

## H SERIES SNAP-IN ROCKER SWITCHES

### 'BUILD YOUR OWN SWITCH' ORDER GUIDE

Fill in boxes with selections shown for complete model number.  
Allowable options are shown below each respective box.  
Note 'NONE' indicates box may be left empty.

Series	Number of poles	Electrical function	Actuator color	Bezel color	Terminal type	Lens color	Lamp voltage
<b>H</b>	<input type="text"/>	<input type="text"/>	<input type="text"/>	<input type="text"/>	<input type="text"/>	<input type="text"/>	<input type="text"/>
	1 Single 2 Double	1 ON/OFF 2 ON/ON Other functions on request	A White B Black C Chrome G Gun Metal Other colors on request	A White B Black G Gun Metal	Solder lug/ Quick-connect	NONE A Amber G Green R Red Illuminated switches only.	NONE 1 125V 2 250V Illuminated switches only.

Example of completely specified model number:

**H11BB1R1**

### WIRING DIAGRAMS

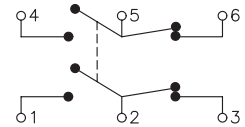
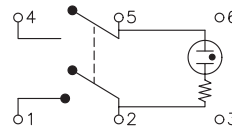
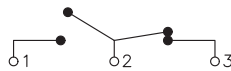
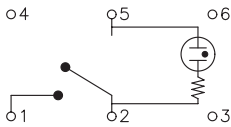

**Illuminated single pole    Non-illuminated single pole    Illuminated double pole    Non-illuminated double pole**

### PANEL CUT-OUT & MINIMUM RECOMMENDED SPACING FOR ADJACENT SWITCHES

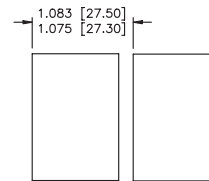
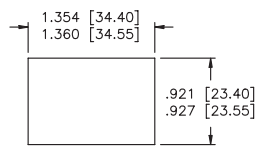

SPECIFICATIONS SUBJECT TO CHANGE WITHOUT NOTICE

**B**