

**Plug-in units type 2 with trapezoid handle, unshielded, kit**
[Print page](#)

3 U

**Article number: 20818-020**

- Front panel unshielded
- Handle without extraction function

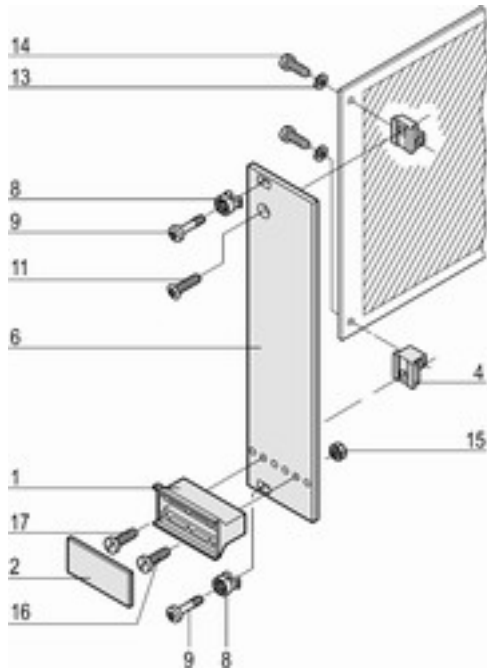

**Delivery comprises: kit**

Item	Qty	Description
1	1	Plastic handle, trapezium shape, PPE, grey
2	1	Identification plate, Al, 1.5 mm, anodised, cut edges plain
4	2	Printed board bracket, Zn, die-cast
6	1	Front panel for trapezium shaped handle, front anodised, rear iridescent green chromated
8	2	Sleeve, PA, grey, up to 7 HP front panel width
8	4	Sleeve, PA, grey, from 8 HP front panel width
9	2	Pozidrive/slotted collar screw, St, nickel-plated, M2.5 x 11 and 12.3, up to 7 HP front panel width
9	4	Pozidrive/slotted collar screw, St, nickel-plated, M2.5 x 11 and 12.3, from 8 HP front panel width
11	1	Raised countersunk screw, St, nickel-plated, M2.5 x 8
13	2	Washer, A2.7, DIN 125
14	2	Flathead screw, St, nickel-plated, M2.5 x 10
15	1	Hexagon nut, St, nickel-plated, M2.5
16	1	Flathead screw, St, nickel-plated, M2.5 x 12
17	1	Flathead screw, St, nickel-plated, M2.5 x 16

**Technical data:**

Description	Height	Width	Height B
Plug-in unit with cantilever handle (kit)	3 U	6 HP	0 mm

**Further Information:**

	Download CAD data in DWG format Download CAD data in DXF format
	User Manual