



N-Channel 60-V (D-S) Single and Quad MOSFETs

PRODUCT SUMMARY				
Part Number	V _{(BR)DSS} Min (V)	r _{DS(on)} Max (Ω)	V _{GS(th)} (V)	I _D (A)
2N6660	60	3 @ V _{GS} = 10 V	0.8 to 2	1.1
VQ1004J/P		3.5 @ V _{GS} = 10 V	0.8 to 2.5	0.46

FEATURES

- Low On-Resistance: 1.3 Ω
- Low Threshold: 1.7 V
- Low Input Capacitance: 35 pF
- Fast Switching Speed: 8 ns
- Low Input and Output Leakage

BENEFITS

- Low Offset Voltage
- Low-Voltage Operation
- Easily Driven Without Buffer
- High-Speed Circuits
- Low Error Voltage

APPLICATIONS

- Direct Logic-Level Interface: TTL/CMOS
- Drivers: Relays, Solenoids, Lamps, Hammers, Displays, Memories, Transistors, etc.
- Battery Operated Systems
- Solid-State Relays

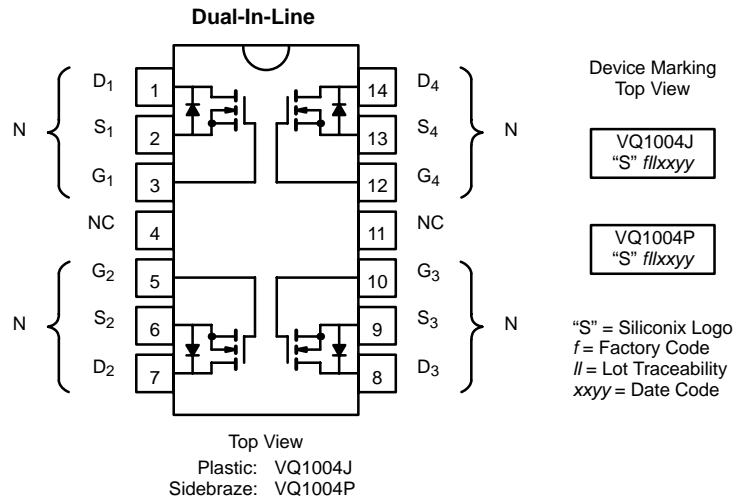
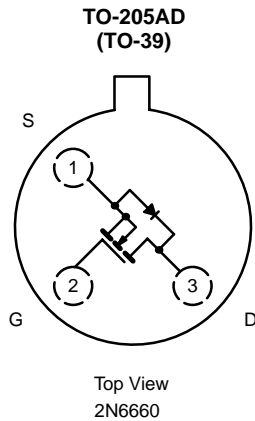

ABSOLUTE MAXIMUM RATINGS (T _A = 25 °C UNLESS OTHERWISE NOTED)							
Parameter	Symbol	2N6660	Single		Total Quad	Unit	
			VQ1004J	VQ1004P	VQ1004J/P		
Drain-Source Voltage	V _{DS}	60	60	60		V	
Gate-Source Voltage	V _{GS}	±20	±30	±20			
Continuous Drain Current (T _J = 150 °C)	I _D	T _C = 25 °C	1.1	0.46	±0.46	A	
		T _C = 100 °C	0.8	0.26	0.26		
Pulsed Drain Current ^a	I _{DM}	3	2	2			
Power Dissipation	P _D	T _C = 25 °C	6.25	1.3	1.3	2	W
		T _C = 100 °C	2.5	0.52	0.52	0.8	
Thermal Resistance, Junction-to-Ambient ^b	R _{thJA}	170	0.96	0.96	62.5	°C/W	
Thermal Resistance, Junction-to-Case	R _{thJC}	20					
Operating Junction and Storage Temperature Range	T _J , T _{stg}	-55 to 150					°C

Notes

- a. Pulse width limited by maximum junction temperature.
 b. This parameter not registered with JEDEC.



SPECIFICATIONS (T _A = 25 °C UNLESS OTHERWISE NOTED)								
Parameter	Symbol	Test Conditions	Typ ^a	Limits				Unit
				2N6660		VQ1004J/P		
				Min	Max	Min	Max	
Static								
Drain-Source Breakdown Voltage	V _{(BR)DSS}	V _{GS} = 0 V, I _D = 10 μA	75	60		60		V
Gate-Threshold Voltage	V _{GS(th)}	V _{DS} = V _{GS} , I _D = 1 mA	1.7	0.8	2	0.8	2.5	
Gate-Body Leakage	I _{GSS}	V _{DS} = 0 V, V _{GS} = ±15 V			±100		±100	nA
		T _C = 125 °C			±500		±500	
Zero Gate Voltage Drain Current	I _{DSS}	V _{DS} = 60 V, V _{GS} = 0 V			10			μA
		V _{DS} = 35 V, V _{GS} = 0 V						
		V _{DS} = 48 V, V _{GS} = 0 V					1	
		T _C = 125 °C			500		500	
		V _{DS} = 28 V, V _{GS} = 0 V						
		T _C = 125 °C						
On-State Drain Current ^b	I _{D(on)}	V _{DS} = 10 V, V _{GS} = 10 V	3	1.5		1.5		A
Drain-Source On-Resistance ^b	r _{DS(on)}	V _{GS} = 5 V, I _D = 0.3 A ^d	2		5		5	Ω
		V _{GS} = 10 V, I _D = 1 A	1.3		3		3.5	
		T _C = 125 °C ^d	2.4		4.2		4.9	
Forward Transconductance ^b	g _{fs}	V _{DS} = 10 V, I _D = 0.5 A	350	170		170		mS
Common Source Output Conductance ^b	g _{os}	V _{DS} = 10 V, I _D = 0.1 A	1					
Diode Forward Voltage	V _{SD}	I _S = 0.99 A, V _{GS} = 0 V	0.8					V
Dynamic								
Input Capacitance	C _{iss}	V _{DS} = 24 V, V _{GS} = 0 V f = 1 MHz	35		50		60	pF
Output Capacitance	C _{oss}		25		40		50	
Reverse Transfer Capacitance	C _{rss}		7		10		10	
Drain-Source Capacitance	C _{ds}		30		40			
Switching^c								
Turn-On Time	t _{ON}	V _{DD} = 25 V, R _L = 23 Ω I _D ≅ 1 A, V _{GEN} = 10 V R _G = 25 Ω	8		10		10	ns
Turn-Off Time	t _{OFF}		8.5		10		10	

Notes

- a. For DESIGN AID ONLY, not subject to production testing.
- b. Pulse test: PW ≤ 80 μs duty cycle ≤ 1%.
- c. Switching time is essentially independent of operating temperature.
- d. This parameter not registered with JEDEC on 2N6660.

VNDQ06



TYPICAL CHARACTERISTICS ($T_A = 25^\circ\text{C}$ UNLESS OTHERWISE NOTED)

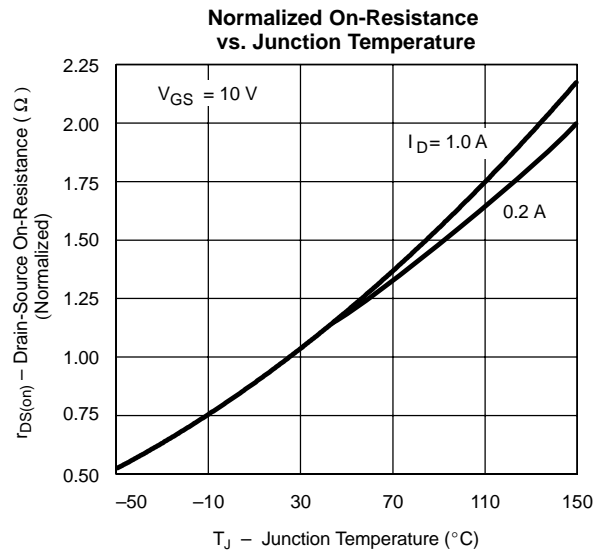
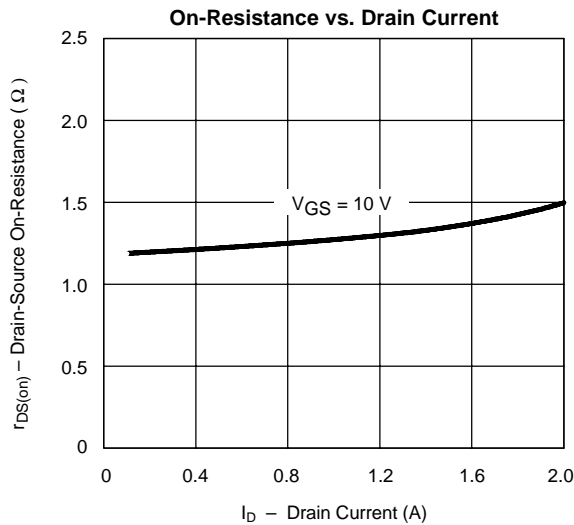
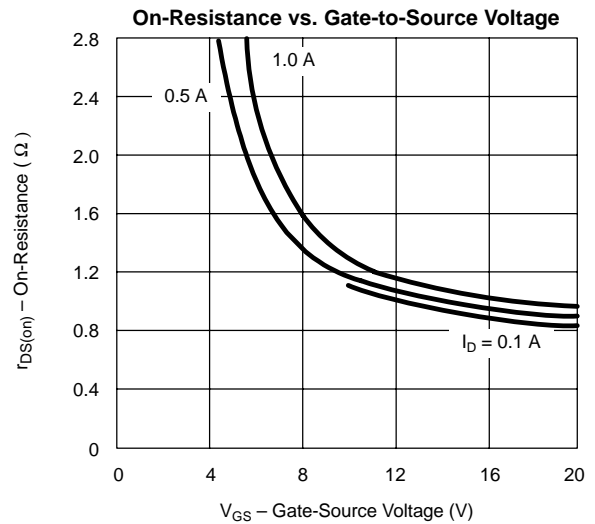
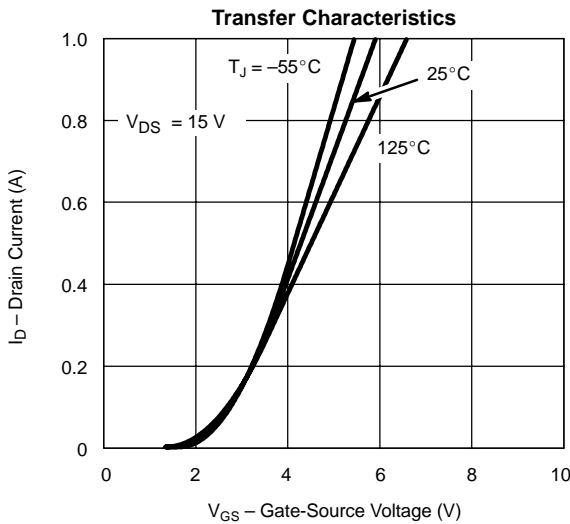
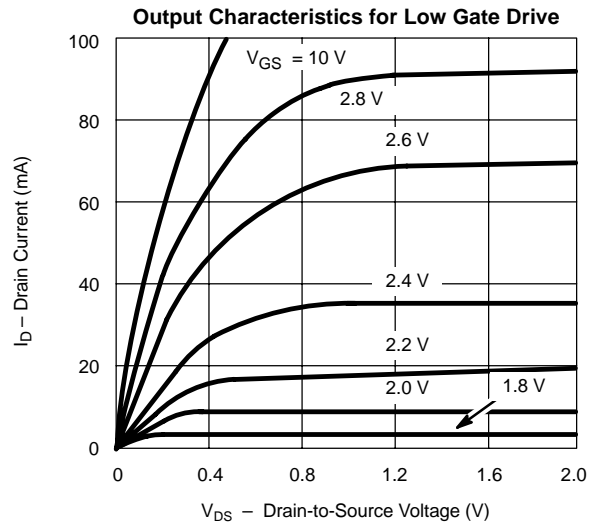
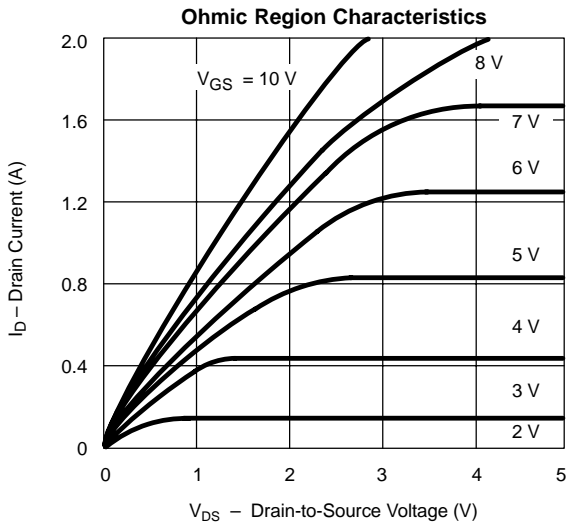

TYPICAL CHARACTERISTICS ($T_A = 25^\circ\text{C}$ UNLESS OTHERWISE NOTED)

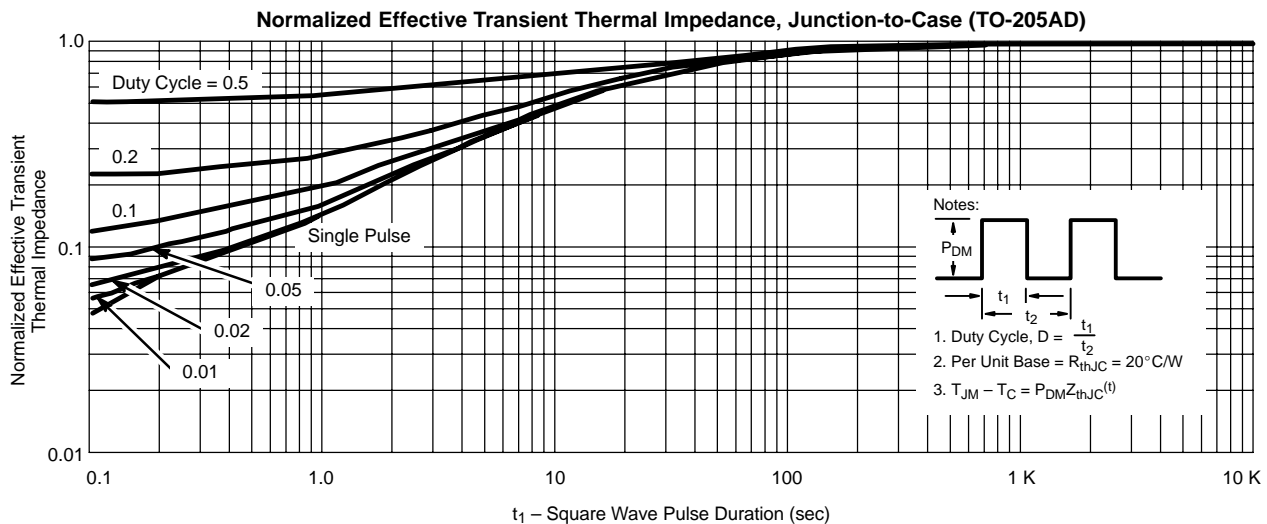
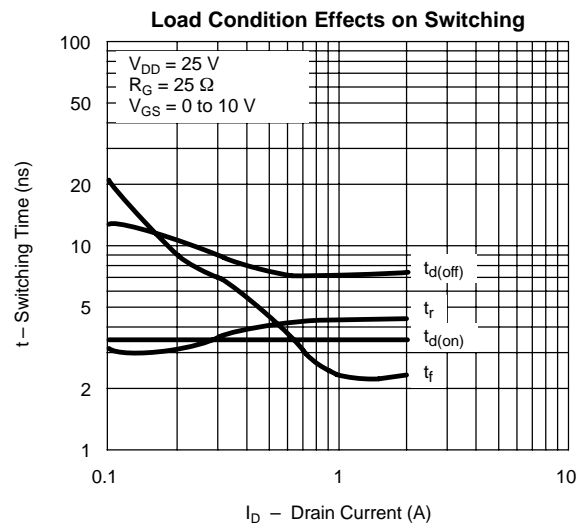
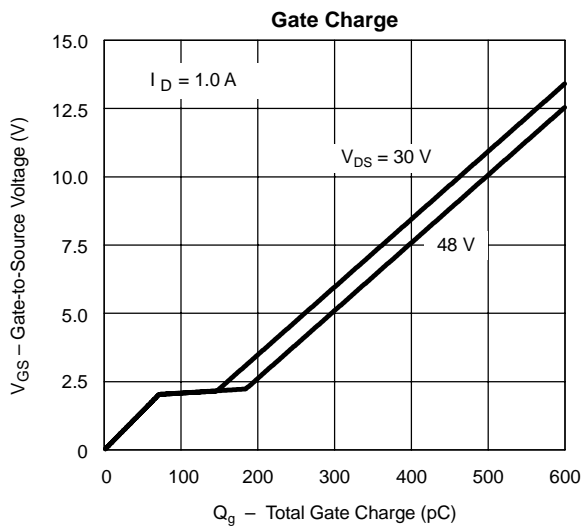
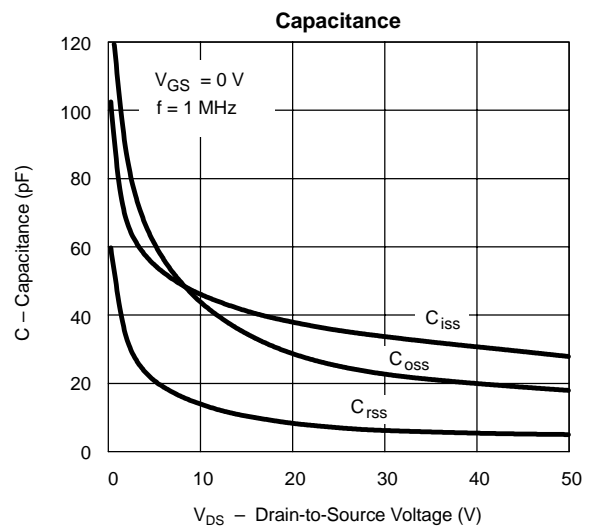
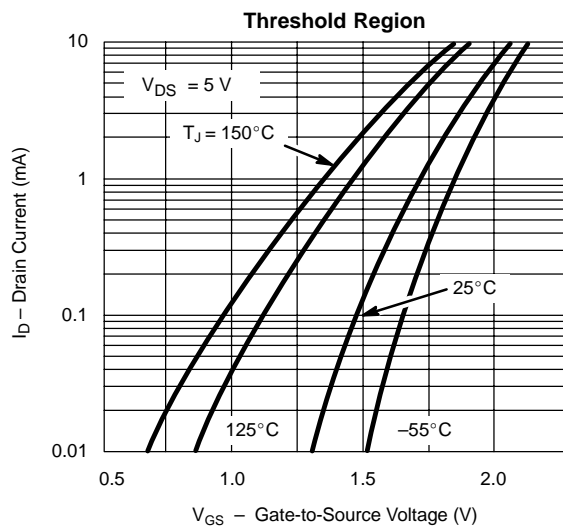



Disclaimer

All product specifications and data are subject to change without notice.

Vishay Intertechnology, Inc., its affiliates, agents, and employees, and all persons acting on its or their behalf (collectively, "Vishay"), disclaim any and all liability for any errors, inaccuracies or incompleteness contained herein or in any other disclosure relating to any product.

Vishay disclaims any and all liability arising out of the use or application of any product described herein or of any information provided herein to the maximum extent permitted by law. The product specifications do not expand or otherwise modify Vishay's terms and conditions of purchase, including but not limited to the warranty expressed therein, which apply to these products.

No license, express or implied, by estoppel or otherwise, to any intellectual property rights is granted by this document or by any conduct of Vishay.

The products shown herein are not designed for use in medical, life-saving, or life-sustaining applications unless otherwise expressly indicated. Customers using or selling Vishay products not expressly indicated for use in such applications do so entirely at their own risk and agree to fully indemnify Vishay for any damages arising or resulting from such use or sale. Please contact authorized Vishay personnel to obtain written terms and conditions regarding products designed for such applications.

Product names and markings noted herein may be trademarks of their respective owners.