

# SPECIFICATION

MODEL : SLHNNWH629T0S0R0S3

[Rank : (S0), (R0), (S3)]

## HIGH POWER LED – SUNNIX6

CUSTOMER : \_\_\_\_\_

CUSTOMER		
CHECKED	CHECKED	APPROVED

SAMSUNG LED			
DRAWN	CHECKED(Sales)	CHECKED(Quality)	APPROVED

SAMSUNG LED CO.,LTD.

# Contents

1. Product outline	.....	3
2. Absolute Maximum Rating	.....	3
3. Characteristics	.....	3
4. Chromaticity Diagram	.....	4
5. Typical Characteristic Graphs	.....	5
6. Outline Drawing and Dimension	.....	6
7. Package Structure	.....	7
8. Solder Conditions	.....	7
9. Reliability Test Items and Conditions	.....	8
10. Taping Dimension	.....	9
11. Label Structure	.....	10
12. Lot Number	.....	10
13. Reel Packing Structure	.....	11
14. Precaution for Use	.....	13
15. Hazard Substance Analysis	.....	14
16. Revision History	.....	18

# 1. Product Outline

## 1) Features

- Plastic Molded Lead Frame Type : 8.0 mm(L), 8.0 mm(W), 3.9 mm(T)
- High Luminous Flux LED
- Built In 9 LED Chips
- Beam View Angle( $\Delta\theta$ )\* : 120 °
- Lead(Pb) Free Product : RoHS Compliant

## 2) Applications

- General Illumination
- Down Lighting
- Decorative Lighting

※ View Angle describes the spatial intensity distribution and is the difference between the angles corresponding to 50% of the maximum intensity.

# 2. Absolute Maximum Rating

- Operation Forward Current ..... 180 mA
- Peak Pulsed Forward Current ..... 250 mA  
(Duty 1/10 and Pulse Width 10 msec)
- Reverse Voltage\* ..... 16.5 V
- Thermal Resistance ( $R_{th\ j-s}$ ) .....  $\cong 9\text{ }^{\circ}\text{C/W}$
- Operating Temperature Range ( $T_{OPR}$ ) .....  $-40\text{ }^{\circ}\text{C} \sim 85\text{ }^{\circ}\text{C}$
- Storage Temperature Range ( $T_{STG}$ ) .....  $-40\text{ }^{\circ}\text{C} \sim 110\text{ }^{\circ}\text{C}$
- LED Junction Temperature ( $T_j$ ) ..... 120 °C

※ Does not operate in the reverse direction.

# 3. Characteristics

## 1) Electrical properties ( $T_j = 25\text{ }^{\circ}\text{C}$ )

Parameter	Symbol	Condition	Rank	Min.	Typ.	Max.	Unit
Reverse Voltage	$V_R$	$I_R = 10\text{ mA}$	-	12.0	-	16.5	V
Forward Voltage	$V_F$	$I_F = 180\text{ mA}$	S0	8.9	-	11.0	V

## 2) Chromaticity Coordinates ( $T_j = 25\text{ }^{\circ}\text{C}$ )

Rank	CCT(K)	Condition	CCx				CCy			
R0	5000~6000	$I_F = 180\text{ mA}$	0.3250	0.3428	0.3484	0.3200	0.2981	0.3138	0.3885	0.3600

## 3) Luminous Flux ( $T_j = 25\text{ }^{\circ}\text{C}$ )

Rank	Symbol	Condition	Min.	Typ.	Max.	Unit
S3	$\Phi_V$	$I_F = 180\text{ mA}$	120	152	180	lm

※ Tolerance :  $V_F : \pm 0.1$ ,  $\Phi_V : \pm 10\%$ , CCx CCy :  $\pm 0.02$

※ Luminous Flux : Typ. 97 lm/W (@120 mA)

※ Color Rendering Index ( $R_a$ ) : Typ. 62

## 4. Chromaticity Diagram

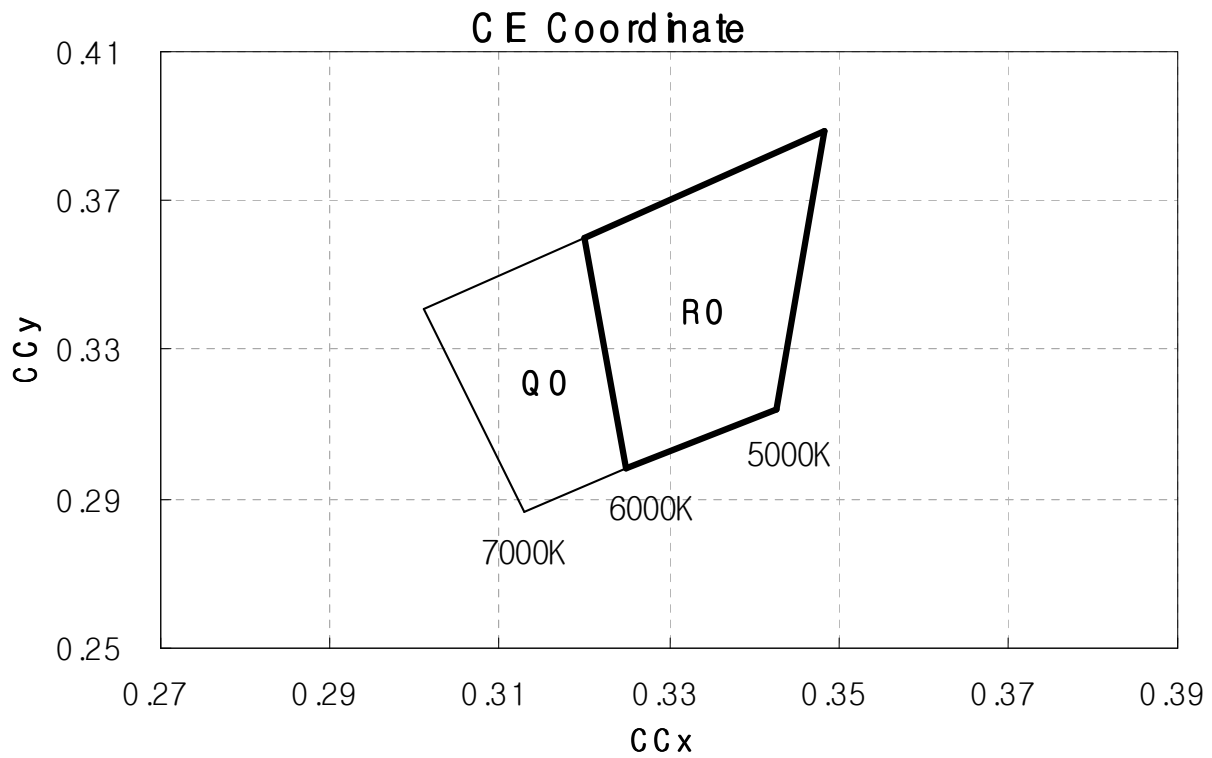

### Approved Rank

Symbol	$V_F$	CIE	$\Phi_v$
Rank	S0	R0	S3

# 5. Typical Characteristic Graphs

$T_j = 25\text{ }^\circ\text{C}$

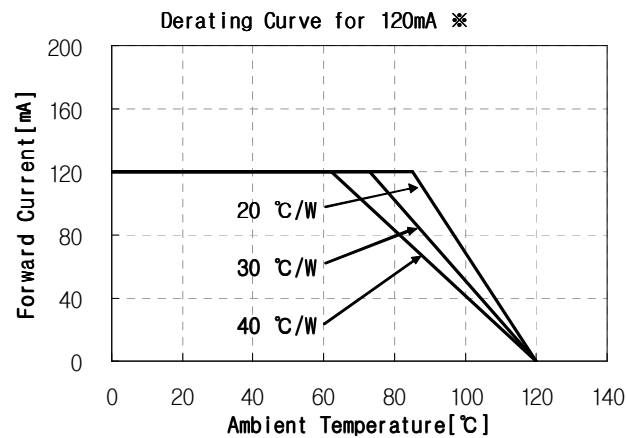
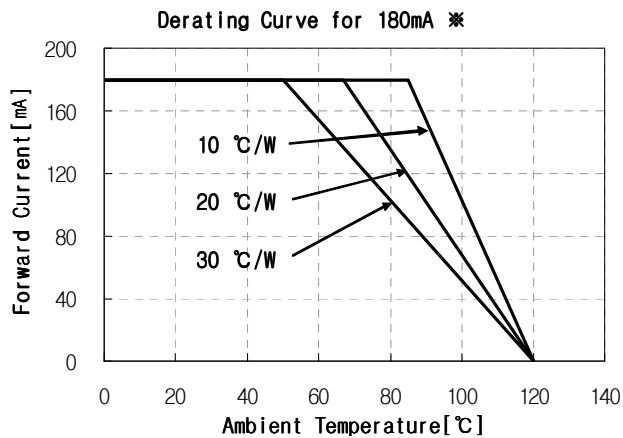
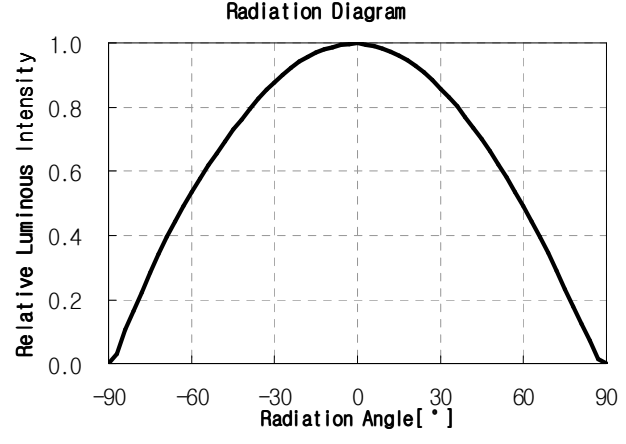
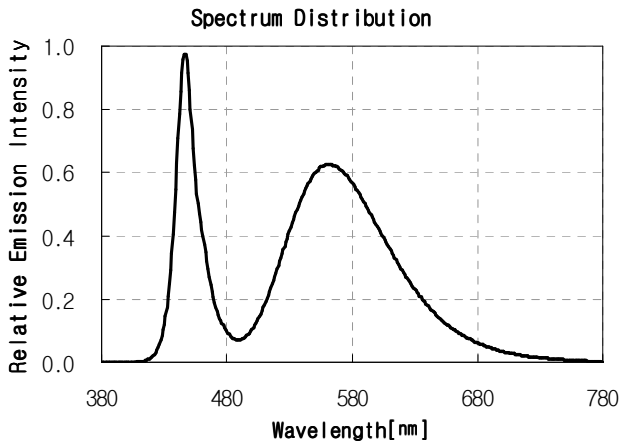
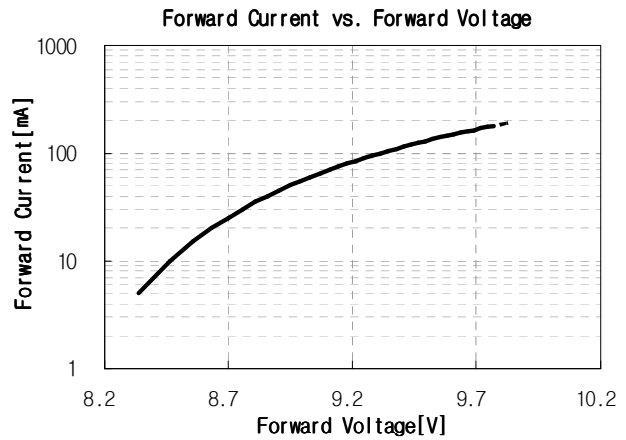
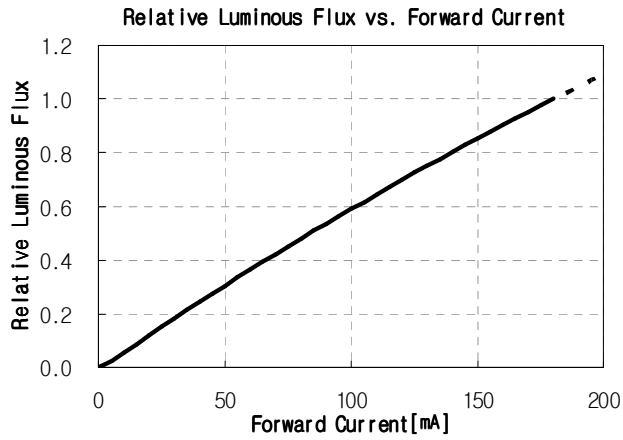

※ Thermal Resistance Test Conditions

- Junction to ambient thermal resistance

- JEDEC Standard JESD 51-2,3

JESD 51-2 : Integrated Circuits Thermal Test Method Environmental Conditions

- Natural Convection (Still Air)

JESD 51-3 : Low Effective Thermal Conductivity Test Board for Leaded Surface Mount Package

## 6. Outline Drawing and Dimension

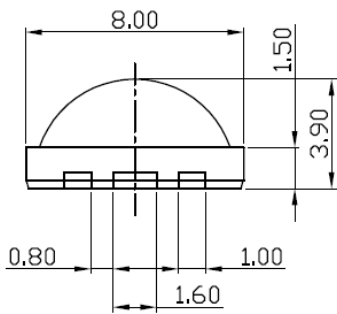
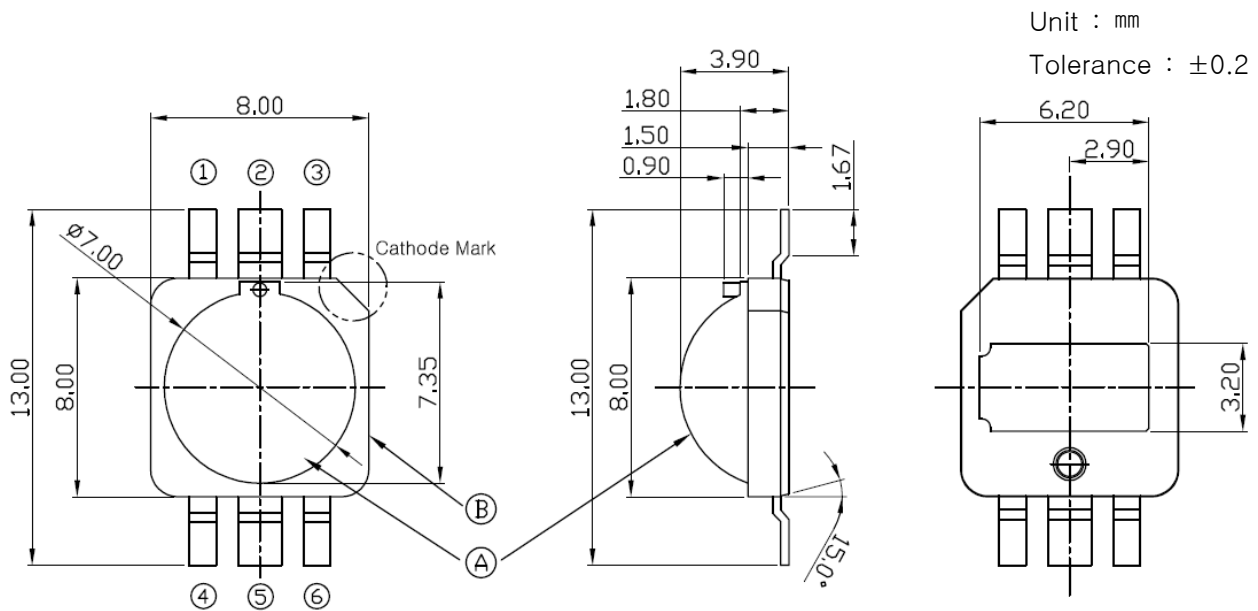

Pick and Place

1. Do not place pressure on the encapsulating resin ("A")
2. The maximum compressing force is 15N on the polymer ("B")

### Circuit

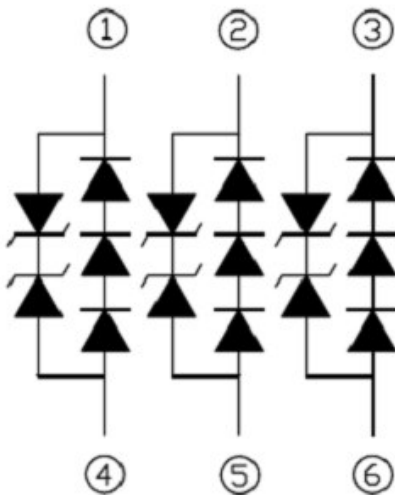

### Solder Pattern for Surface Mount

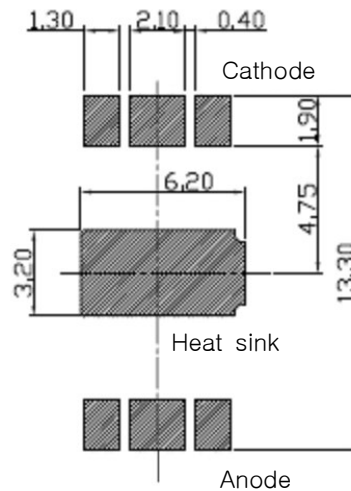

### Remarks

Make sure that the heat sink is electrically connected to the Anode.  
Heat sink is to be soldered, If not, use the heat conductive adhesive.

## 7. Package Structure

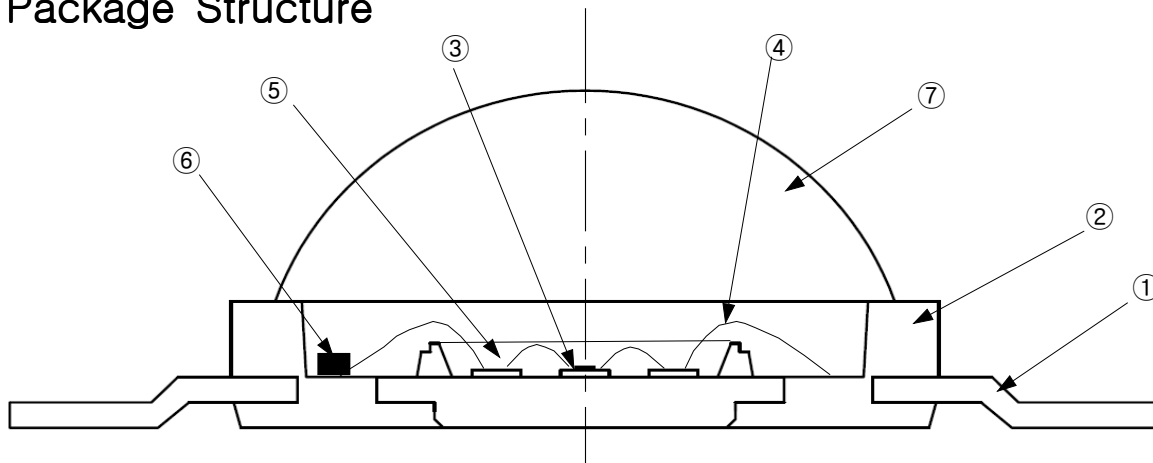

No	Component	Material
①	Frame	Copper frame(Silver plated)
②	Package	Heat-resistant polymer
③	LED chip	GaN
④	Wire	Gold wire
⑤	Encapsulant	Silicone + Phosphor
⑥	Zener diode	Si
⑦	Lens	Silicone

## 8. Solder Conditions

### 1) Reflow Conditions (Pb-Free)

Reflow Frequency : 2 time max.

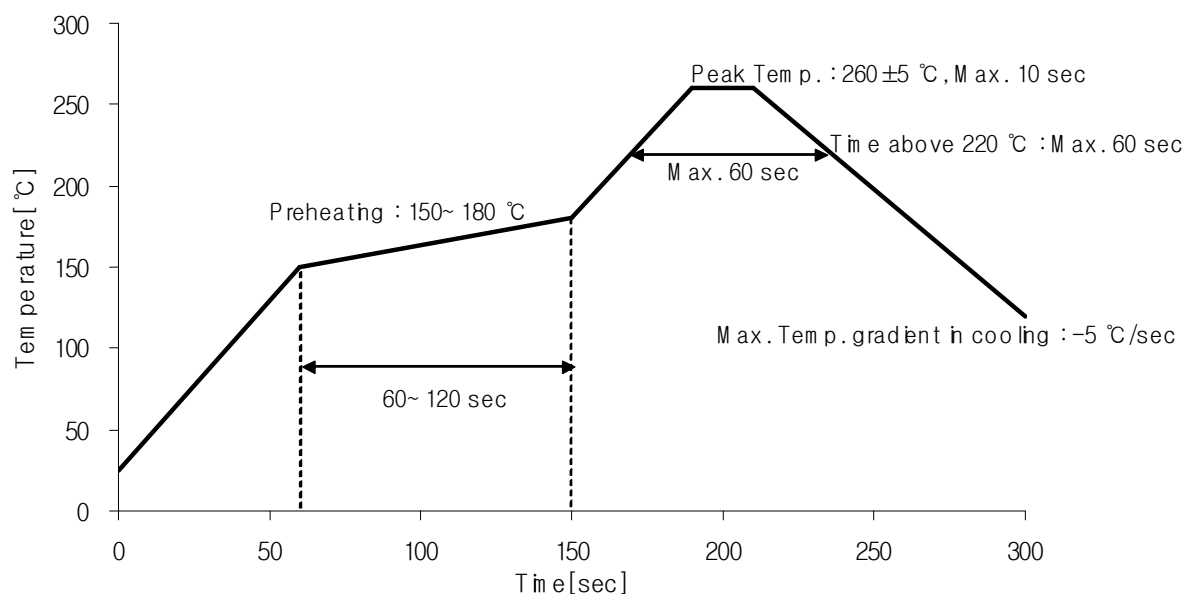

### 2) For Manual Soldering

Not more than 5 seconds @Max. 300 °C, under soldering iron.

## 9. Reliability Test Items and Conditions

### 1) Test Items

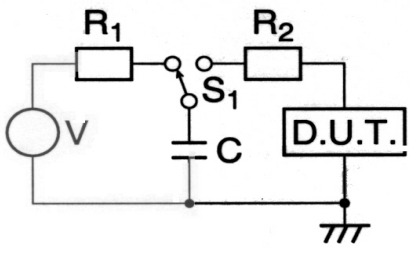
Test Items	Test Conditions	Test Hours/Cycles
Room Temperature life test	25 °C, $I_F = \text{Max DC}^*$	1,000 h
High Temperature humidity life test	85 °C, 60 % RH, $I_F = \text{Max DC}^*$	1,000 h
High Temperature life test	85 °C, $I_F = \text{Max DC}^*$	1,000 h
Low Temperature life test	-40 °C, $I_F = \text{Max DC}^*$	1,000 h
High Temperature Storage	110 °C	1,000 h
Low Temperature Storage	-40 °C	1,000 h
Thermal Shock	-40 / 120 °C, each 30 min	200 cycles
Temperature humidity Cycle On/Off test	-40 / 85 °C, each 20 min, 100 min transfer Power On/off each 5 min, DC 180 mA	100 cycles
Reflow (Pb-Free)	Peak 260±5 °C for 10 sec	3 times
ESD(HBM)	 <p style="text-align: center;">R1 : 10 MΩ , R2 : 1.5 kΩ , C : 100 pF</p>	3 times (± 5 kV)

\* Max. DC current is depending on maximum current derating curve.

### 2) Criteria for Judging the Damage

Item	Symbol	Test Condition	Limit	
			Min	Max
Forward Voltage	$V_F$	$I_F = 180 \text{ mA}$	-	U.S.L.*1.2
Luminous Flux	$\Phi_V$	$I_F = 180 \text{ mA}$	L.S.L.*0.5	-
Reverse Voltage	$V_R$	$I_R = 5 \text{ mA}$	-	U.S.L.*2.0

\* U.S.L : Upper Standard Level, L.S.L : Lower Standard Level



# 10. Taping Dimension

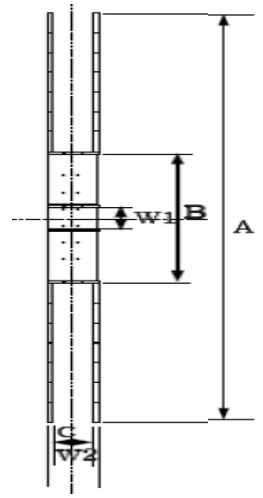
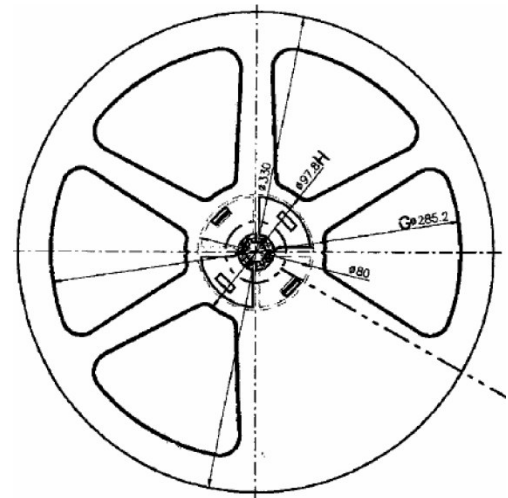
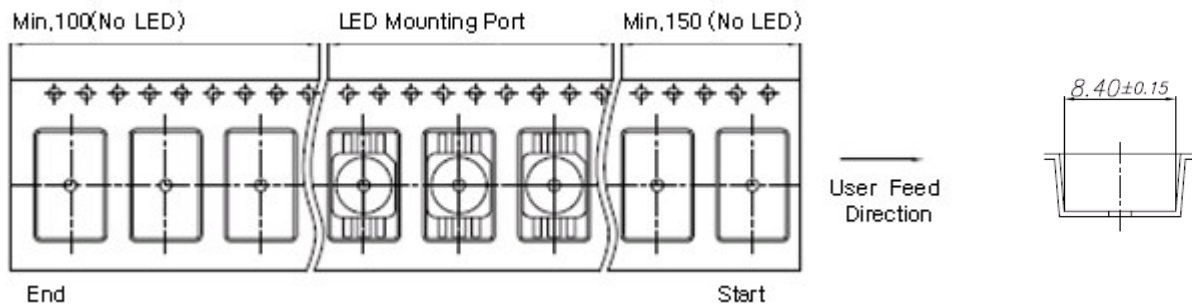
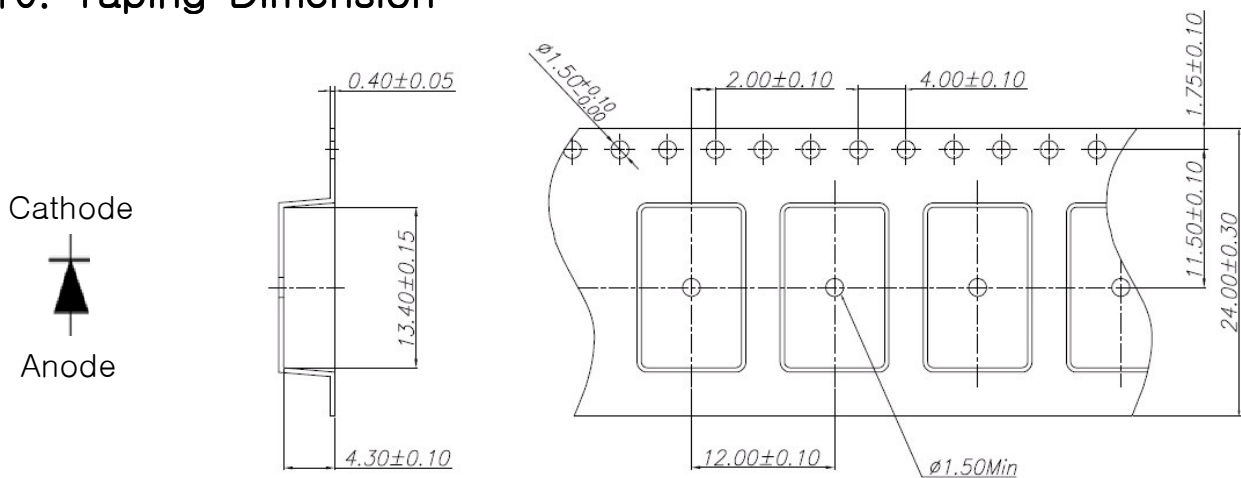

Symbol	A	B	C	W1	W2
Dimension(mm)	330 ± 1	80 ± 1	25 ± 0.5	13 ± 0.3	29.5 ± 1

- (1) Quantity : 1,000 Pcs / 13" Reel.
- (2) Cumulative Tolerance : Cumulative Tolerance/10 pitches is less than ±0.2 mm
- (3) Adhesion Strength of Cover Tape : Adhesion strength to be 0.1–0.7N when the cover tape is turned off from the carrier tape at 10 °C angle to be the carrier tape.
- (4) Packaging : P/N, Manufacturing data Code No. and quantity to be indicated on a damp proof Package

## 11. Label Structure

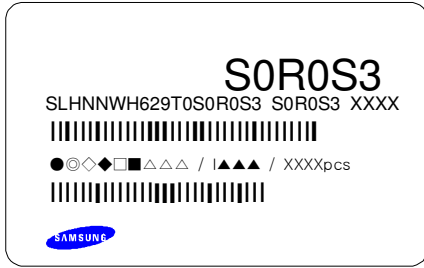

### Rank Code

/S0/ : VF Rank (refer to page 3)

/R0/ : Chromaticity Coordinate Rank, CIE (refer to page 3)

/S3/ : Luminous Flux (refer to page 3)

## 12. Lot Number

The Lot number is composed of the following characters

●◎◇◆□■△△△ / |▲▲▲ / 1000PCS

● : Production Site (S:SAMSUNG LED, G:Gosin China)

◎ : L (LED)

◇ : Product State (A:Normality, B:Bulk, C:First Production, R:Reproduction, S:Sample)

◆ : Year (S:2008, T:2009, U:2010...)

□ : Month (1 ~ 9, A, B)

■ : Day (1 ~ 9, A, B ~ V)

△ : SAMSUNG LED Product Number (1 ~ 999)

▲ : Reel Number (1 ~ 999)

# 13. Reel Packing Structure

## 1) Reel

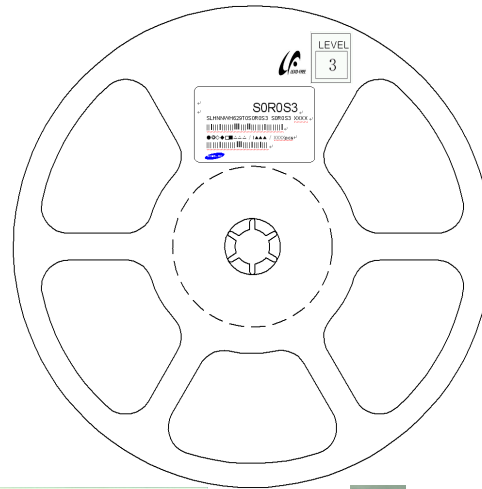
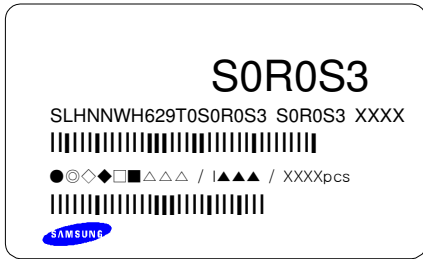

## 2) Aluminum Bag

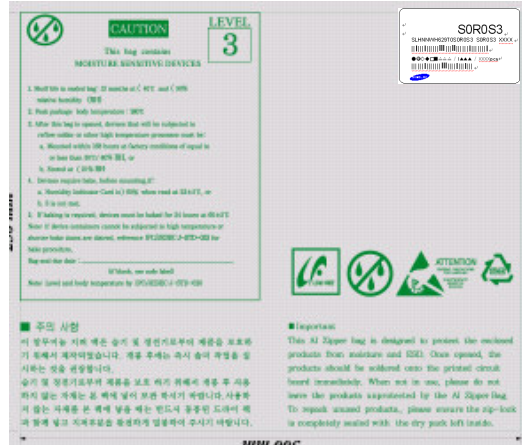
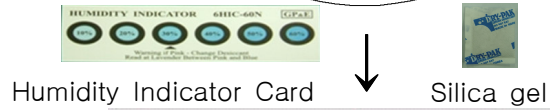

## 3) Inner Box

Material : Paper(SW3B(B))

TYPE	SIZE(mm)		
	L	W	H
13inch	335	45	335

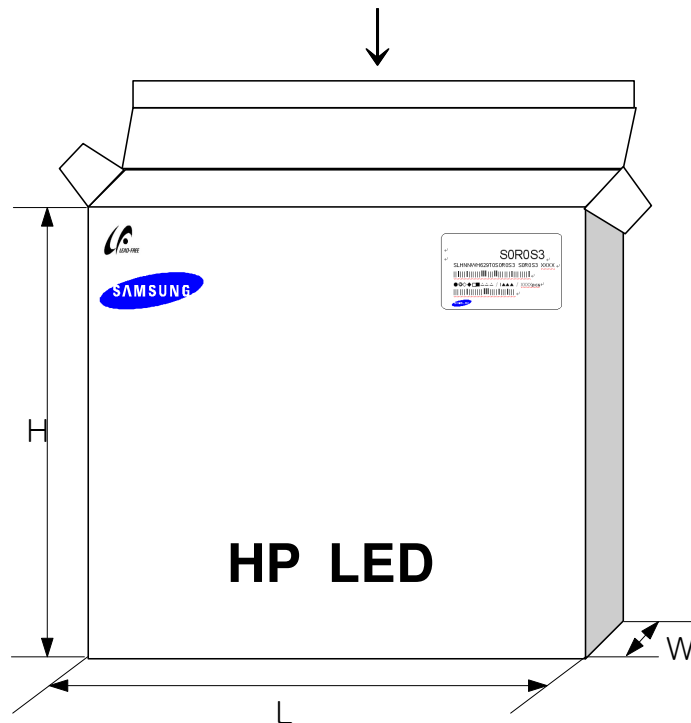

#### 4) Carton Box

Material : Paper(SW3B(B))

TYPE	SIZE(mm)		
	L	W	H
13inch	350	350	350

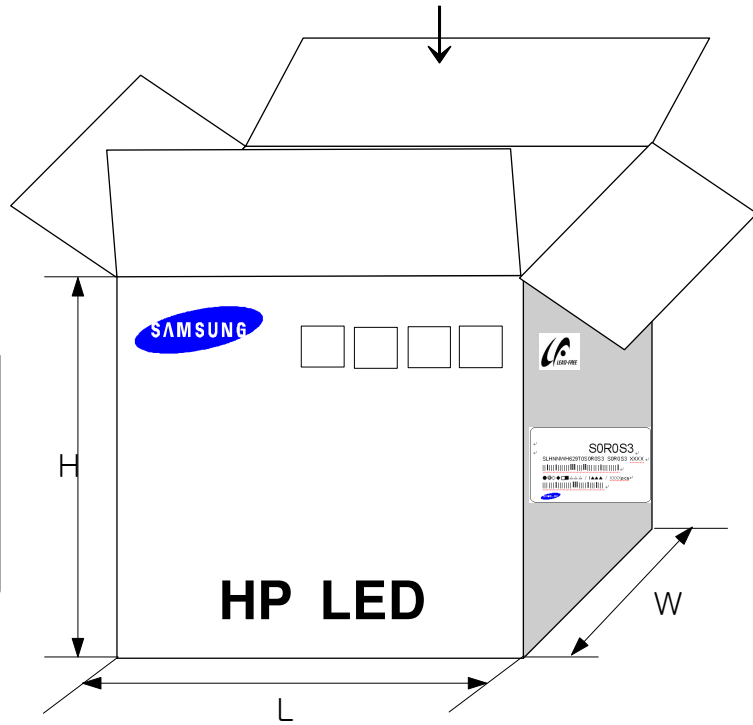
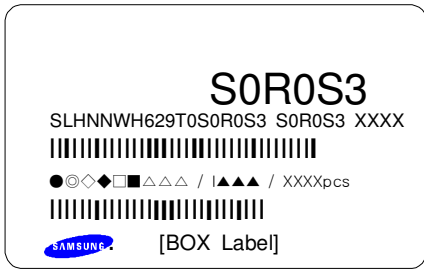

## 14. Precaution for Use

- 1) For over-current-proof function, customers are recommended to apply resistors to prevent sudden change of the current caused by slight shift of the voltage.
- 2) This device should not be used in any type of fluid such as water, oil, organic solvent, etc. When washing is required, IPA is recommended to use.
- 3) When the LEDs illuminate, operating current should be decided after considering the ambient maximum temperature.
- 4) LEDs must be stored in a clean environment. If the LEDs are to be stored for 3 months or more after being shipped from SAMSUNG LED, they should be packed by a sealed container with nitrogen gas injected. (Shelf life of sealed bags : 12 months, temp. 0~40°C, 20~70%RH)
- 5) After storage bag is open, device subjected to soldering, solder reflow, or other high temperature processes must be:
  - a. Mounted within 72 hours (3days) at an assembly line with a condition of no more than 30°C/60%RH,
  - b. Stored at <10% RH.
- 6) Repack unused Products with anti-moisture packing, fold to close any opening and then store in a dry place.
- 7) Devices require baking before mounting, if humidity card reading is >60% at 23±5°C.
- 8) Devices must be baked for 24hours at 65±5°C, if baking is required.
- 9) The LEDs are sensitive to the static electricity and surge. It is recommended to use a wrist band or anti-electrostatic glove when handling the LEDs.

If voltage exceeding the absolute maximum rating is applied to LEDs, it may cause damage or even destruction to LED devices.

Damaged LEDs may show some unusual characteristics such as increase in leak current, lowered turn-on voltage, or abnormal lighting of LEDs at low current.

# 15. Hazard Substance Analysis



**Test Report No.** F690501/LF-CTSAYAA08-28494R1

**Issued Date:** October 27, 2008

Page 1 of 4

**To:** SAMSUNG ELECTRO-MECHANICS CO., LTD.  
314, Maetan3-dong  
Yeongtong-gu  
Suwon-city  
GYEONGGI-DO 442-373  
Korea

The following merchandise was submitted and identified by the client as :

**Product Name** : LED  
**SGS File No.** : AYAA08-28494R1  
**Received Date** : October 20, 2008  
**Test Performing Date** : October 21, 2008  
**Test Performed** : SGS Testing Korea tested the sample(s) selected by applicant with following results  
**Test Results** : For further details, please refer to following page(s)  
**Comments** : By the applicant's specific request, the sampling and testing was performed only for the part indicated in the photo without disassembly. This Report supersedes the Report No.F690501/LF-CTSAYAA08-28494 dated October 27,2008 issued by SGS Testing Korea Co.,Ltd. The item/part no. is changed from SLHNNWW829T0 to SLHNNWW829T0(SLHNNWW829T0) by customer's request. The test result of (PBB/PBDE) are extracted from the test report number F690501/LF-CTSAYAA08-29674 where the sample is claimed to be identical.

Pluto Kim  
Monet Jeong  
Billy Oh / Testing Person

SGS Testing Korea Co. Ltd.

Jeff Jang / Chemical Lab Mgr

\*This document is issued by the Company under its General Conditions of Service printed online or available on request and accessible at [http://www.sgs.com/terms\\_and\\_conditions.htm](http://www.sgs.com/terms_and_conditions.htm). Attention is drawn to the limitation of liability, indemnification and jurisdiction issues defined therein. Any holder of this document is advised that information contained hereon reflects the Company's findings at the time of its intervention only and within the limits of Client's instructions, if any. The Company's sole responsibility is to its Client and this document does not exonerate parties to a transaction from exercising all their rights and obligations under the transaction documents. Any unauthorized alteration, forgery or falsification of the content or appearance of this document is unlawful and offenders may be prosecuted to the fullest extent of the law. Unless otherwise stated the results shown in this test report refer only to the sample(s) tested. This document cannot be reproduced except in full, without prior approval of the Company.



Test Report No. F690501/LF-CTSAYAA08-28494R1

Issued Date: October 27, 2008

Page 2 of 4

Sample No. : AYAA08-28494R1.001  
 Sample Description : LED  
 Item No./Part No. : SLHNNWW629T0(SLHNNWH629T0)

Heavy Metals

Test Items	Unit	Test Method	MDL	Results
Cadmium (Cd)	mg/kg	US EPA 3052(1996), US EPA 6010B(1996), ICP	0.5	N.D.
Lead (Pb)	mg/kg	US EPA 3052(1996), US EPA 6010B(1996), ICP	5	N.D.
Mercury (Hg)	mg/kg	US EPA 3052(1996), US EPA 6010B(1996), ICP	2	N.D.
Hexavalent Chromium (Cr VI)	mg/kg	US EPA 3060A(1996), US EPA 7196A(1992), UV	1	N.D.

Flame Retardants-PBBs/PBDEs

Test Items	Unit	Test Method	MDL	Results
Monobromobiphenyl	mg/kg	US EPA 3540C, GC/MS	5	N.D.
Dibromobiphenyl	mg/kg	US EPA 3540C, GC/MS	5	N.D.
Tribromobiphenyl	mg/kg	US EPA 3540C, GC/MS	5	N.D.
Tetrabromobiphenyl	mg/kg	US EPA 3540C, GC/MS	5	N.D.
Pentabromobiphenyl	mg/kg	US EPA 3540C, GC/MS	5	N.D.
Hexabromobiphenyl	mg/kg	US EPA 3540C, GC/MS	5	N.D.
Heptabromobiphenyl	mg/kg	US EPA 3540C, GC/MS	5	N.D.
Octabromobiphenyl	mg/kg	US EPA 3540C, GC/MS	5	N.D.
Nonabromobiphenyl	mg/kg	US EPA 3540C, GC/MS	5	N.D.
Decabromobiphenyl	mg/kg	US EPA 3540C, GC/MS	5	N.D.
Monobromodiphenyl ether	mg/kg	US EPA 3540C, GC/MS	5	N.D.
Dibromodiphenyl ether	mg/kg	US EPA 3540C, GC/MS	5	N.D.
Tribromodiphenyl ether	mg/kg	US EPA 3540C, GC/MS	5	N.D.
Tetrabromodiphenyl ether	mg/kg	US EPA 3540C, GC/MS	5	N.D.
Pentabromodiphenyl ether	mg/kg	US EPA 3540C, GC/MS	5	N.D.
Hexabromodiphenyl ether	mg/kg	US EPA 3540C, GC/MS	5	N.D.
Heptabromodiphenyl ether	mg/kg	US EPA 3540C, GC/MS	5	N.D.
Octabromodiphenyl ether	mg/kg	US EPA 3540C, GC/MS	5	N.D.
Nonabromodiphenyl ether	mg/kg	US EPA 3540C, GC/MS	5	N.D.
Decabromodiphenyl ether	mg/kg	US EPA 3540C, GC/MS	5	N.D.

- NOTE: (1) N.D. = Not detected.(<MDL)  
 (2) mg/kg = ppm  
 (3) MDL = Method Detection Limit  
 (4) - = No regulation  
 (5) \*\* = Qualitative analysis (No Unit)  
 (6) Negative = Undetectable / Positive = Detectable

\*This document is issued by the Company under its General Conditions of Service printed on-site or available on request and accessible at [http://www.sgs.com/terms\\_and\\_conditions.htm](http://www.sgs.com/terms_and_conditions.htm). Attention is drawn to the limitation of liability, indemnification and jurisdiction issues defined therein. Any holder of this document is advised that information contained herein reflects the Company's findings at the time of its intervention only and within the limits of Client's instructions, if any. The Company's sole responsibility is to its Client and this document does not exonerate parties to a transaction from exercising all their rights and obligations under the transaction documents. Any unauthorized alteration, forgery or falsification of the content or appearance of this document is unlawful and offenders may be prosecuted to the fullest extent of the law. Unless otherwise stated the results shown in this test report refer only to the sample(s) tested. This document cannot be reproduced except in full, without prior approval of the Company.



Test Report No. F690501/LF-CTSAYAA08-28494R1

Issued Date: October 27, 2008

Page 3 of 4

Sample No. : AYAA08-28494R1.001

Sample Description : LED

Item No./Part No. : SLHNNWW629TD(SLHNNWH629TD)

**Halogen Contents**

Test Items	Unit	Test Method	MDL	Results
Bromine(Br)	mg/kg	BS EN 14582:2007 , IC	30	N.D.
Chlorine(Cl)	mg/kg	BS EN 14582:2007 , IC	30	N.D.
Fluorine(F)	mg/kg	BS EN 14582:2007 , IC	30	N.D.
Iodine(I)	mg/kg	BS EN 14582:2007 , IC	30	N.D.

**Other(s)**

Test Items	Unit	Test Method	MDL	Results
PFOS(Perfluorooctane Sulfonates-Acid/Metal Salt/Amide)	mg/kg	US EPA 3540C, LC/MS	1	N.D.

- NOTE: (1) N.D. = Not detected.(<MDL)  
(2) mg/kg = ppm  
(3) MDL = Method Detection Limit  
(4) - = No regulation  
(5) \*\* = Qualitative analysis (No Unit)  
(6) Negative = Undetectable / Positive = Detectable

\*This document is issued by the Company under its General Conditions of Service printed on-site or available on request and accessible at [http://www.sgs.com/sgs\\_en/conditions.html](http://www.sgs.com/sgs_en/conditions.html). Attention is drawn to the limitation of liability, indemnification and jurisdiction issues defined therein. Any holder of this document is advised that information contained hereon reflects the Company's findings at the time of its intervention only and within the limits of Client's instructions, if any. The Company's sole responsibility is to its Client and this document does not exonerate parties to a transaction from exercising all their rights and obligations under the transaction documents. Any unauthorized alteration, forgery or falsification of the content or appearance of this document is unlawful and offenders may be prosecuted to the fullest extent of the law. Unless otherwise stated the results shown in this test report refer only to the sample(s) tested. This document cannot be reproduced except in full, without prior approval of the Company.



Picture of Sample as Received:

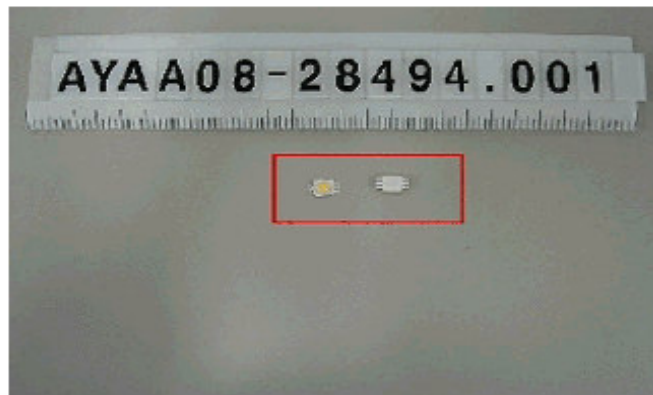

\*\*\* End \*\*\*

- NOTE:
- (1) N.D. = Not detected.(<MDL)
  - (2) mg/kg = ppm
  - (3) MDL = Method Detection Limit
  - (4) - = No regulation
  - (5) \*\* = Qualitative analysis (No Unit)
  - (6) Negative = Undetectable / Positive = Detectable

\*This document is issued by the Company under its General Conditions of Service printed on-site or available on request and accessible at [http://www.sgs.com/terms\\_and\\_conditions.htm](http://www.sgs.com/terms_and_conditions.htm). Attention is drawn to the limitation of liability, indemnification and jurisdiction issues defined therein. Any holder of this document is advised that information contained herein reflects the Company's findings at the time of its intervention only and within the limits of Client's instructions, if any. The Company's sole responsibility is to its Client and this document does not exonerate parties to a transaction from exercising all their rights and obligations under the transaction documents. Any unauthorized alteration, forgery or falsification of the content or appearance of this document is unlawful and offenders may be prosecuted to the fullest extent of the law. Unless otherwise stated the results shown in this test report refer only to the sample(s) tested. This document cannot be reproduced except in full, without prior approval of the Company.

