

**Series 159 - 1206 - Bipolar bicolor**

**low current**

**Features**

- size 1206: 3,2(L) x 1,6(W) x 1,2(H) mm
- circuit substrate: glass laminated epoxy
- devices are ROHS conform
- lead free solderable, soldering pads: gold plated
- taped in 8 mm blister tape, cathode of defined color is placed to transporting perforation
- all devices sorted into luminous intensity classes
- taping: face-up (T) or face-down (TD) possible



**Absolute Maximum Ratings**

$P_{D, max}$ [mW]	$I_{F, P}$ [mA] $t_p \leq 100 \mu s$ $\tau=1: 10$	$V_R$ [V]	$I_{R, max}$ [ $\mu A$ ]	Thermal resistance $R_{thJA}$ [K / W]	$T_{Op}$ [ $^{\circ}C$ ]	$T_{St}$ [ $^{\circ}C$ ]
65	100	5	100	450	-40...85	-55...85

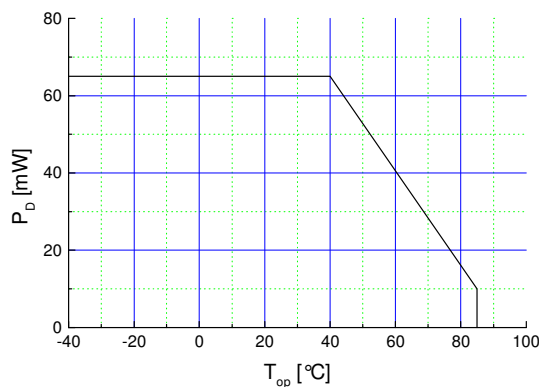

Maximal forward current (DC) characteristic

**Electro-Optical Characteristics**

Type	Combination	Marking at cathode
OLS-159 Y/G	yellow / green	green
OLS-159 SR/G	red / green	green
OLS-159 SR/Y	red / yellow	yellow

Other combinations are possible also

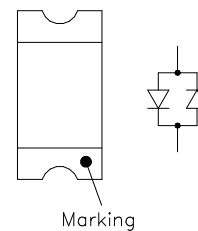

Emitting color	Measurement $I_F$ [mA]	$V_F$ [V]		$\lambda_d / \lambda_p^*$ [nm]	$I_V$ [mcd]	
		typ	max		min	typ
G - green	2	1,9	2,2	572	0.4	1.2
Y - yellow	2	1,8	2,2	590	0.3	0.6
SR - red	2	1,8	2,6	655 *	0.8	2.0

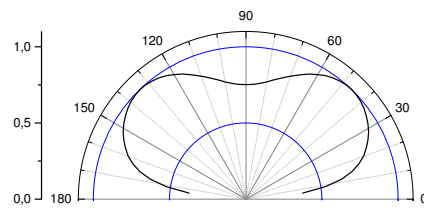

view angle

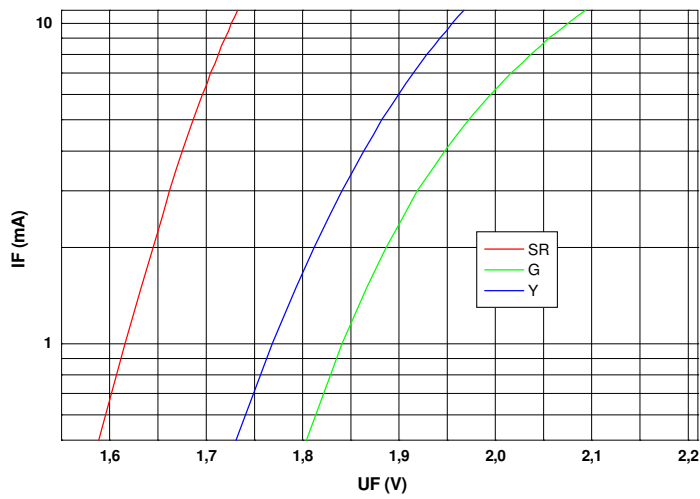

$U_F - I_F$   
characteristic

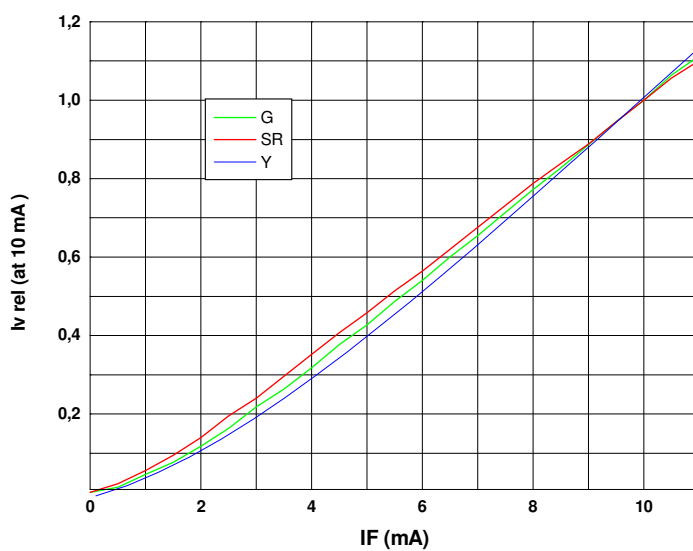

$I_F - I_{v, rel}$   
characteristic

**Outline Drawing**

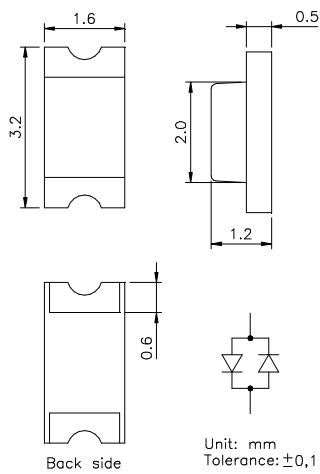

**Recommended Soldering Patterns**

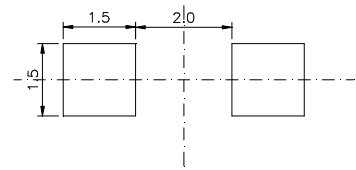

**Soldering Conditions**

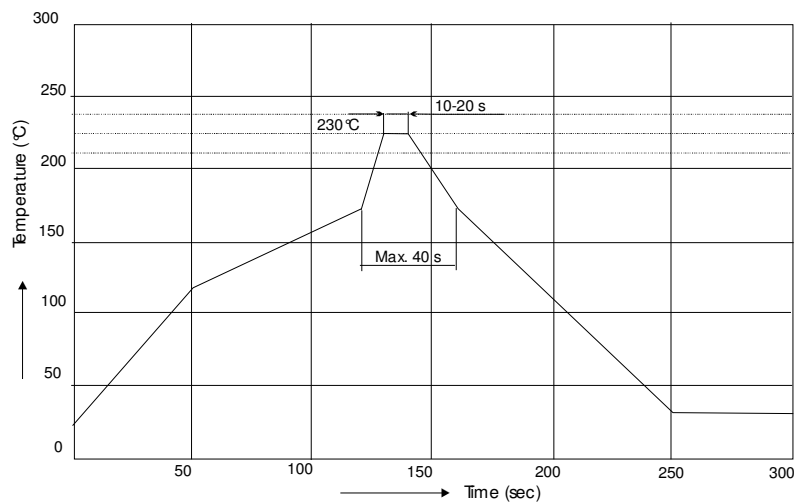

IR reflow soldering profile

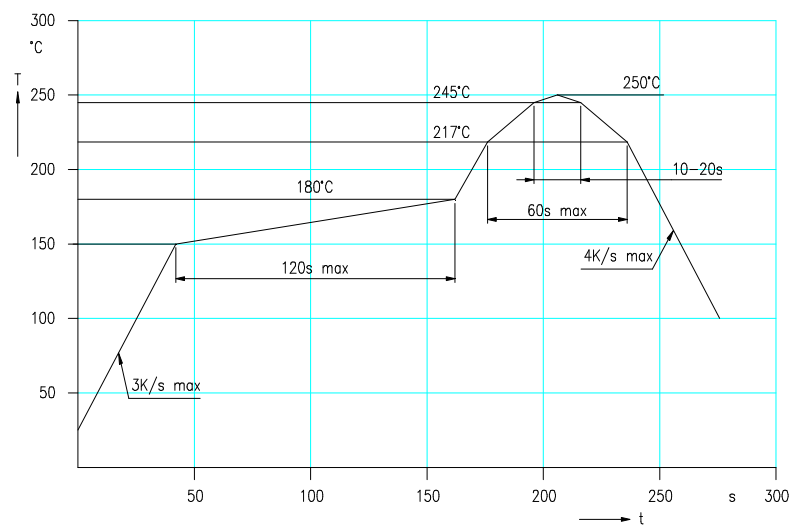

IR reflow soldering profile for lead free soldering

Manual soldering: max power of iron 25W/ 3s/ 300°C

## Ordering Code For Parts

Series	Color	Encapsulation	Packaging
OLS-159	???????	?	?
			T - taped up TD - taped down
			XD - uncolored diffused (standard) CD - colored diffused C - colored clear X - uncolored clear

Type definition, e.g. OLS-159 Y/G-XD-T

## LED Luminous Intensity Groups And Subgroups [ mcd ]

(general information – not this device specific)

C:	0.28 - 0.45	C1:	0.28 - 0.36	Q1:	71 - 90
D:	0.45 - 0.71	C2:	0.36 - 0.45	Q2:	90 - 112
E:	0.71 - 1.12	D1:	0.45 - 0.56	R1:	112 - 140
F:	1.12 - 1.80	D2:	0.56 - 0.71	R2:	140 - 180
G:	1.80 - 2.80	E1:	0.71 - 0.90	S1:	180 - 224
H:	2.80 - 4.50	E2:	0.90 - 1.12	S2:	224 - 280
J:	4.50 - 7.10	F1:	1.12 - 1.40	T1:	280 - 355
K:	7.10 - 11.20	F2:	1.40 - 1.80	T2:	355 - 450
L:	11.20 - 18.00	G1:	1.80 - 2.24	U1:	450 - 560
		G2:	2.24 - 2.80	U2:	560 - 710
M:	18 - 28	H1:	2.80 - 3.55	V1:	710 - 900
N:	28 - 45	H2:	3.55 - 4.50	V2:	900 - 1120
P:	45 - 71	J1:	4.50 - 5.60	W1:	1120 - 1420
Q:	71 - 112	J2:	5.60 - 7.10	W2:	1420 - 1800
R:	112 - 180	K1:	7.10 - 9.00	X1:	1800 - 2250
S:	180 - 280	K2:	9.00 - 11.20	X2:	2250 - 2800
T:	280 - 450	L1:	11.20 - 14.00	Y1:	2800 - 3550
U:	450 - 710	L2:	14.00 - 18.00	Y2:	3550 - 4500
V:	710 - 1120	M1:	18.00 - 22.40	Z1:	4500 - 5750
W:	1120 - 1800	M2:	22.40 - 28.00	Z2:	5750 - 7100
X:	1800 - 2800	N1:	28.00 - 35.50		
Y:	2800 - 4500	N2:	35.50 - 45.00		
Z:	4500 - 7100	P1:	45.00 - 56.00		
		P2:	56.00 - 71.00		

**Measured according to CIE 127. All SMD-LEDs are 100% measured and selected on full automated equipment with an accuracy of  $\pm 11\%$ .**

**Special service: Brightness selection in sub selections possible.  
Color selection in 3 sub selections possible (each subgroup per reel).**

**Tape And Reel Packing**

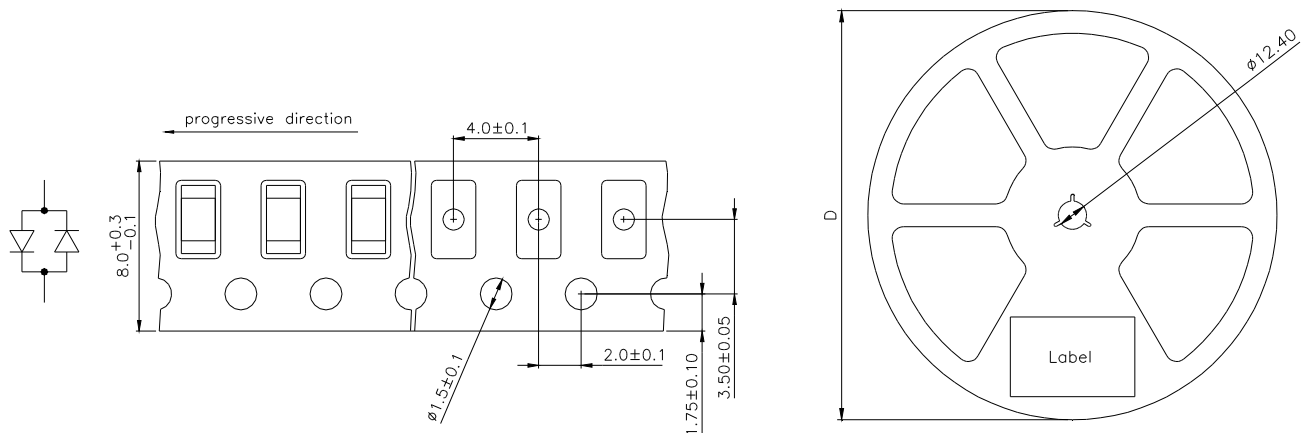

D	Parts/reel
180 mm	3000
330 mm	12000

**Packing:** The reel is sealed in special plastic bag with integrate ESD protection ( MIL - STD 81705 ) including a silica dry-pack

**Label**

Order No.	XXXXXXXXXX	Customer order No.
Type	OLS-159 ?????-??-T	
Intensity group	ZZ	Color class: CC
Charge No.	1122-AAAAAA	Color class - optional
Quantity	9999	11 Week – 22 year – A internal identification

Attention please:

The information describes the type of component and shall not considered as assured characteristics. Terms of delivery and rights to change reserved.

Due to technical requirements components may contain dangerous substances.

The data sheet may changed without prior information; the valid issue will be on our webpage in internet.

Packaging:

Please use the recycling operators known to you.

Components used in life support devices or systems and safety systems must be expressly authorized for such purpose!