

Model EN11

11mm Rotary Encoder

2 Bits Gray Code

Incremental/Contacting Type

Metal Bushing/Shaft

Push-on Switch Option

RoHS Compliant

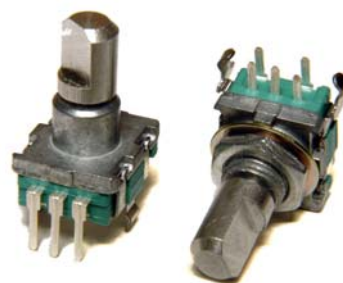

MODEL STYLES

Top Adjust, with Switch, Threaded Bushing	EN11-HSM
Top Adjust, without Switch, Threaded Bushing	EN11-HNM
Top Adjust, with Switch, Plain Bushing	EN11-HSB
Top Adjust, without Switch, Plain Bushing	EN11-HNB
Side Adjust, with Switch, Threaded Bushing	EN11-VSM
Side Adjust, without Switch, Threaded Bushing	EN11-VNM
Side Adjust, with Switch, Plain Bushing	EN11-VSB
Side Adjust, without Switch, Plain Bushing	EN11-VNB

ELECTRICAL¹

Pulses (Per Revolution)	15, 20
Encoder Closed Circuit Resistance	3 Ohms, max.
Encoder Contact Rating	10mA/ 5Vdc
Operating Current, Maximum	10mA
Dielectric Strength	300Vac/1mA, 1 minute
Insulation Resistance, Minimum	100M ohms at 250Vdc/ 1mA
Sliding Noise (at 60 RPM)	2.0ms max.
Contact Bounce (at 15 RPM)	5.0ms max.
Operating Speed (RPM)	100 RPM max.
Switch Power rating	10mA/ 5Vdc
Switch Contact Resistance	100 milliohms
Actual Electrical Travel, Nominal	Continuous

MECHANICAL

Total Mechanical Travel	Continuous
Detents (per Revolution)	0, 15 and 20
Rotational Torque of Detent, Maximum	2.5 oz-in
Switch Operating Force	550 gf
Switch Travel	0.5mm

¹ Specifications subject to change without notice.

Model EN11

ENVIRONMENTAL

Operating Temperature Range

-30°C to +85°C

Rotational Life

30,000 cycles

ORDERING INFORMATION²

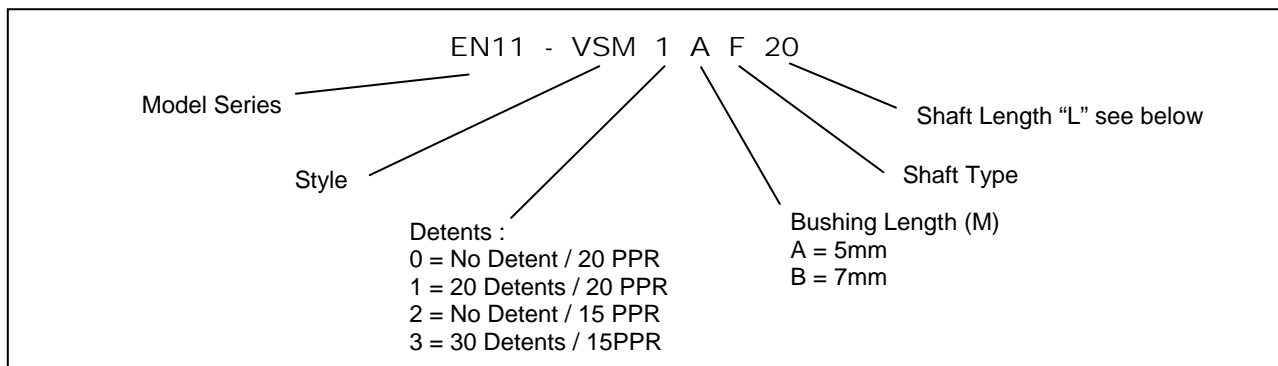

Shaft Types

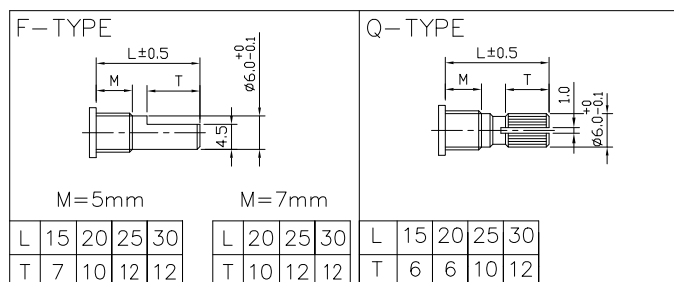

CIRCUIT DIAGRAM

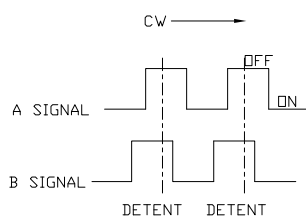

For 20 PPR (B leads A)

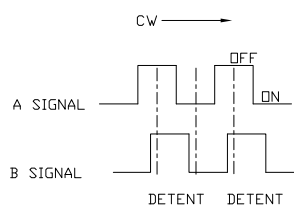

For 15 PPR (A leads B)

² Contact our customer service for custom designs and features.

Model EN11

OUTLINE DRAWING

MODEL EN11-HSM (Top Adjust, with Switch, Threaded Bushing)

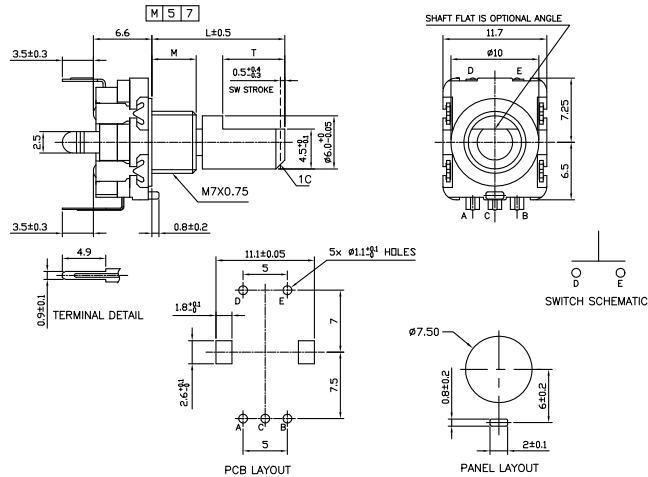

MODEL EN11-HNM (Top Adjust, without Switch, Threaded Bushing)

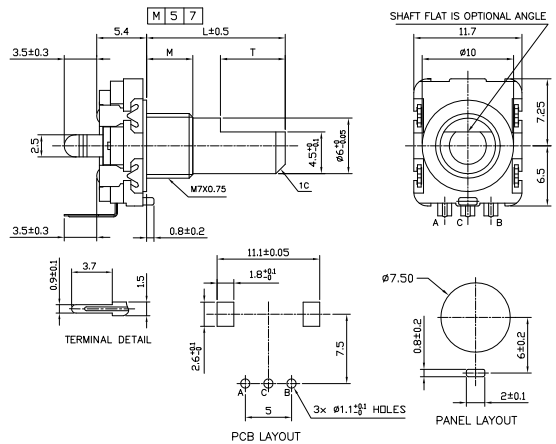

MODEL EN11-HSB (Top Adjust, with Switch, Plain Bushing)

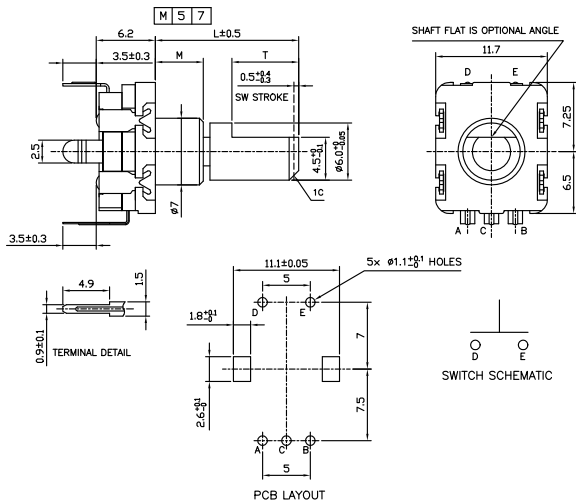

MODEL EN11-HNB (Top Adjust, without Switch, Plain Bushing)

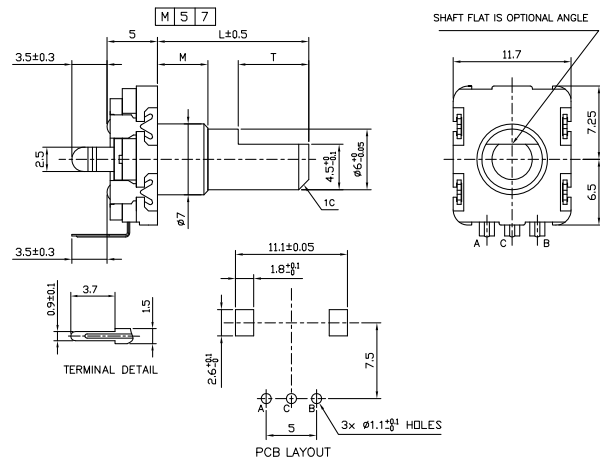

Model EN11

MODEL EN11-VSM (Side Adjust, with Switch, Threaded Bushing)

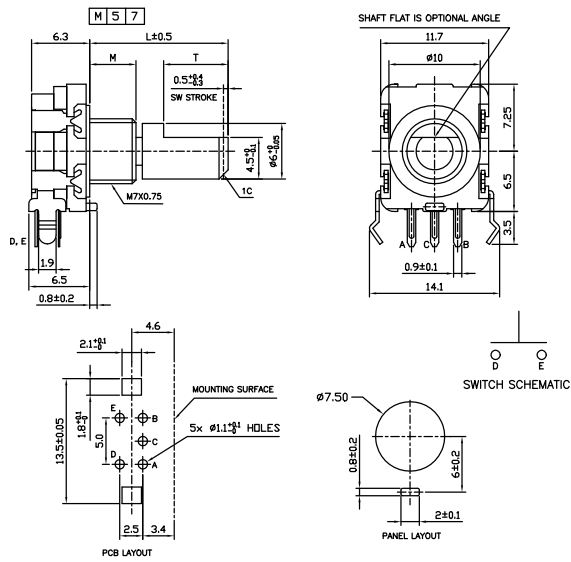

MODEL EN11-VNM (Side Adjust, without Switch, Threaded Bushing)

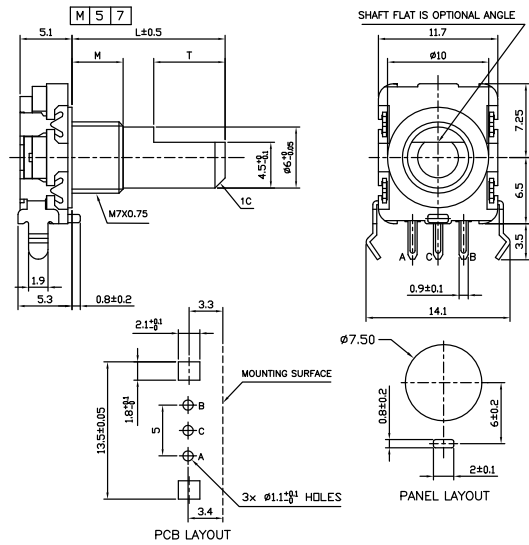

MODEL EN11-VSB (Side Adjust, with Switch, Plain Bushing)

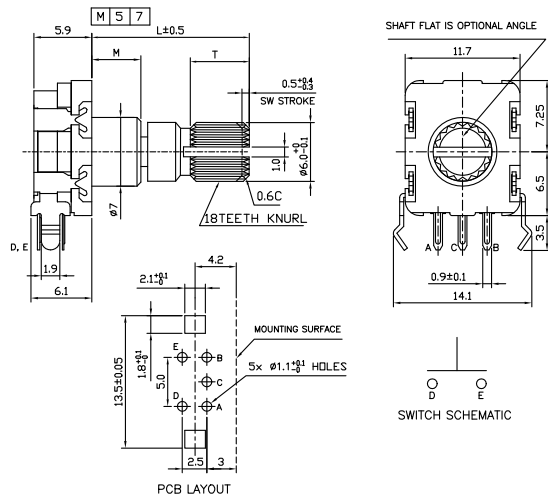

MODEL EN11-VNB (Side Adjust, without Switch, Plain Bushing)

