

Amphenol® 97 Series Standard Cylindrical Connector

12-022-11



Amphenol

This catalog covers the complete line of Amphenol® 97 Series Connectors. It is divided into five sections: 97E (Environmental), 97 Series solder, 97 Series crimp, special application connectors, and accessories:

| Table of Contents | Page |
|---|-------------|
| Amphenol® 97 Series Standard Cylindrical Connectors – General Description | 1 |
| Guide to Selecting a Connector | 2 |
| Amphenol® 97E (Environmental) Series Connectors | |
| Design Features and Benefits | 3 |
| How to Order | 4 |
| Amphenol® 97 Series Connectors with Solder Contacts | |
| Design Characteristics, Customer Options | 5 |
| Insert Availability | 6, 7 |
| Contact Arrangements | 8-13 |
| Alternate Insert Positioning | 14 |
| Receptacle Shell Styles | 15 |
| Solid Shell Plug Styles | 16 |
| Split Shell Plug Styles | 17 |
| Weight Reference Charts | 18-20 |
| How to Order | 21 |
| Amphenol® 97 Series Connectors with Rear Release Crimp Contacts | |
| Design Characteristics, Customer Options | 22 |
| Specifications and Insert Availability, Alternate Insert Positioning | 23 |
| Contact Arrangements | 24, 25 |
| Receptacle Shell Styles | 26 |
| Solid Shell Plug Styles | 27 |
| Split Shell Plug Styles | 28 |
| How to Order | 29 |
| Crimp Contact Information | 30 |
| Crimp Contact Information cont., Tools | 31 |
| Special Purpose Connectors | |
| Potting Construction | 32 |
| Box Type Plugs, Small Flange Receptacles | 33 |
| ECG Connector, Convenience Outlets | 34 |
| 97 Series Accessories | |
| Cable Clamps, Bushing | 35, 36 |
| Protection Caps | 37, 38 |
| Adapters | 39 |
| Conduit Box Connector, Conduit Coupling Nuts, | 40 |
| Sealing Gaskets | 41 |
| Dummy Receptacles | 42 |
| Sales Office Listing | |

Amphenol® 97 Series Connectors

provide the interconnection solution for low cost, general duty and environmental applications

Amphenol offers the 97 Series Connector Family -

A general duty standard cylindrical connector, MIL-C-5015 style, and the recent addition to the family - the 97E Environmental style.

The 97 Series is a widely used connector series for the automotive, robotics, machine tool and welding industries, as well as numerous other commercial applications from heavy equipment to ECG monitoring cables.

Shell components are fabricated from high grade aluminum alloy to provide strength and environmental protection. This family of connectors offers a wide variety of shell styles, contact patterns and accessory options.



The Amphenol® 97 Series design features and benefits include:

- **Low cost, general duty non-environmental or 97E environmental styles**
- **Solder or crimp termination**
- **UL Recognized, CSA Recognized**
- **Wide selection of shell styles and insert patterns**
- **Wide selection of connector finishes - cadmium or non-cadmium (environmentally friendly zinc alloy)**
- **Threaded coupling, hard dielectric inserts**
- **Solid or split shell construction**
- **Accessories for both individual wire seal and jacketed cable**

For additional information on Amphenol® 97 Series connectors, or for special application requirements, contact your local Amphenol sales office, authorized distributor, or -

Amphenol Corporation
Amphenol Aerospace
40-60 Delaware Avenue
Sidney, New York 13838-1395
Telephone: 607-563-5011
Fax: 607-563-5157
Web site: www.Amphenol-Aerospace.com

Guide to Selecting a Connector

In selecting a connector, it first must be determined if a non-environmental (97 A/B Series) type or an environmental (97E) type is required.

Then the following 8 steps apply to formulation of a part number.*

1 How many wires are you going to connect? What gauge?

These two questions are important, because they indicate which insert you need. There are literally hundreds to choose from.

The insert arrangements for solder contact connectors are illustrated on pages 8-13. The inserts most often used are highlighted on these pages.

Here's an example of how to choose an insert arrangement. Say you want to connect eight 16-ga. wires, - first find the section of arrangements containing 8 contacts. Insert number 20-7 is the one you want because it contains eight 16-ga. contacts and it is one of the most often used. The one you choose might depend on your space or voltage requirements. The voltage capacity of each insert is listed under its diagram.

If you have more than one wire size to connect, the method is essentially the same. Actually, the insert configurations for multiple-size wires are a lot more flexible than they appear. That's because you can always solder a smaller wire to a larger contact. However, soldering a large wire to a small contact isn't recommended because of size and current requirements.

2 What if several identical connectors have different functions?

Here's a situation to watch out for. You have four identical receptacles on a panel. One carries high current loads. The others have low current functions. A plug mated with the wrong receptacle (cross-mating) could ruin your valuable equipment.

To avoid cross-mating, you can order identical inserts positioned in

both the plugs and receptacles at various angles from standard. These variations from standard position are called alternate insert positions, and are described on page 14.

3 What kind of receptacle do you need?

For Wall Mounting Use a wall receptacle, type 3100. The elongated back of this receptacle extends through thick wall material. It is threaded to accept standard hardware fittings.

For Unmounted Applications Use the cable receptacle, type 3101.

For Box or Panel Mounting Use the box receptacle, type 3102. This receptacle's back is short to conserve space. It is not threaded on the back end and is used when no accessories such as clamps are needed.

4 What kind of plug do you need?

For ordinary situations The straight plug, type 3106 meets most connector requirements. However . . .

when space is critical you may want to consider using an angle plug, type 3108. This type plug lets the cable enter your equipment at a right angle.

5 Do you need a plug with a Solid or Split back shell?

You can get both straight and angle plugs in solid or split back shell designs. With the solid shell you have greater strength and you save space. On the other hand, the split shell design lets you quickly inspect the solder terminals when you need to. This feature could be important if you'll be subjecting the connector to rough handling and heavy use.

The designation to use for solid shell construction in an non-environmental type is the letter A. For a solid shell construction in the 97E environmental sealing type the designation is E. This designation letter goes immediately after the main shell type number: for example, 3106A or 3108A.

The designation for split shell construc-

tion is the letter B; for example, 3106B or 3108B. Split shell construction is available in non-environmental types only.

Because of application, receptacles are made in solid backshell construction only. Their designation is 3100A/E, 3101A/E. (See how to order for solder contact connectors, page 21, and how to order for 97E on page 4).

6 Which connector gets the socket? - the receptacle or the plug?

You're at the point where you designate which inserts are used with which shells. Either pin or socket inserts can be used with plugs or receptacles.

Here's a good rule of thumb. Order the sockets for the connector at the "hot" side of the circuit. By having sockets at the power source, there's little chance that a wayward finger or screwdriver will short the circuit or cause personal injury.

The designation for sockets is simply S in a part number, following the insert code number. For pins, the designation is P. Therefore, the 20-7P insert would have pin contacts, while the 20-7S insert would have socket contacts.

7 What type of plating is preferred?

If you prefer the standard olive cadmium, non-reflective, electrically conductive finish, then no suffix number is required. Other plating variations are available, including environmentally friendly zinc alloy. See how to order instructions for the various plating finishes offered for 97 Series solder connectors on page 21, and for 97E types on page 4.

8 Do you need any accessories?

Accessories - cable clamps, protection caps and chains, conduit adapters, and panel gaskets are shown on pages 35-41.

* These steps are for solder type connectors which are described in detail on pages 5-21. If a crimp type connector is needed, the same steps apply, however, you should consult pages 22-31 for details on 97 Series connectors with crimp contacts. And, for 97E environmental type connectors, you should consult pages 3 and 4.

Amphenol® 97E (environmental) series Connectors

NEW DESIGN FROM AMPHENOL COMBINES AN ENVIRONMENTAL SERVICE CLASS WITH THE COST EFFECTIVE BENEFITS OF THE GENERAL DUTY 97 SERIES

Amphenol, continuing to meet the needs of today's interconnection products marketplace, now offers the 97E (Environmental) Series

Incorporating a sealing gasket in the plug and standard use of environmental backshell accessories to provide a low cost, general duty, and environmentally sealed connector.

The Amphenol® 97E Series connector can be used in a variety of industrial applications where environmental sealing is required, such as:

- Automotive
- Robotics
- Machine Tool
- Welding Equipment

The Amphenol® 97E Series provides environmental sealing in the mated condition when used with the proper rear accessory hardware. Environmental sealing is accomplished with the addition of a sealing gasket in the plug interface and standard use of environmental, MIL-C-5015 type "E" backshell accessories. This includes a grommet for individual wire sealing and a backshell with clamp bars to provide axial strain relief. If the application requires the use of jacketed cable, a standard deviation, (290), in the part number callout can provide the M85049/2 type cable clamp. (See how to order information on the back side of this sheet). The incorporation of these environmental accessories will prevent moisture from entering the rear of the connector.

The 97E (Environmental) Series is offered by Amphenol with the same wide variety of shell styles and insert arrangements that are available in the 97 Series, the proven, industry standard.

L-2089 assembly instructions for 97E is available. Consult Amphenol, Sidney, NY for copies.



Amphenol 97E (Environmental) Series for Individual Wire Sealing



Amphenol 97E (Environmental) Series for use with Jacketed Cable

Features of Amphenol® 97E (Environmental) Series Connectors with MIL-C-5015 style insert arrangements:

- Environmental sealing through use of
 - Sealing gaskets
 - MIL-C-5015 E/F backshells
- Low cost, general duty, environmental
- Solder or crimp termination
- Crimp applications apply to jacketed cable only (290 suffix)
- Wide selection of shell styles and insert patterns
- Wide selection of platings - cadmium or environmentally friendly zinc alloy
- Threaded coupling, hard dielectric inserts
- Intermateable and intermountable with existing 97 Series

97E (environmental) series

how to order

Example of part number for environmental 97E Series connectors is given below.

(For non-environmental solder type connectors how to order, see pg. 21, and for non-environmental crimp type connectors how to order, see pg. 29).

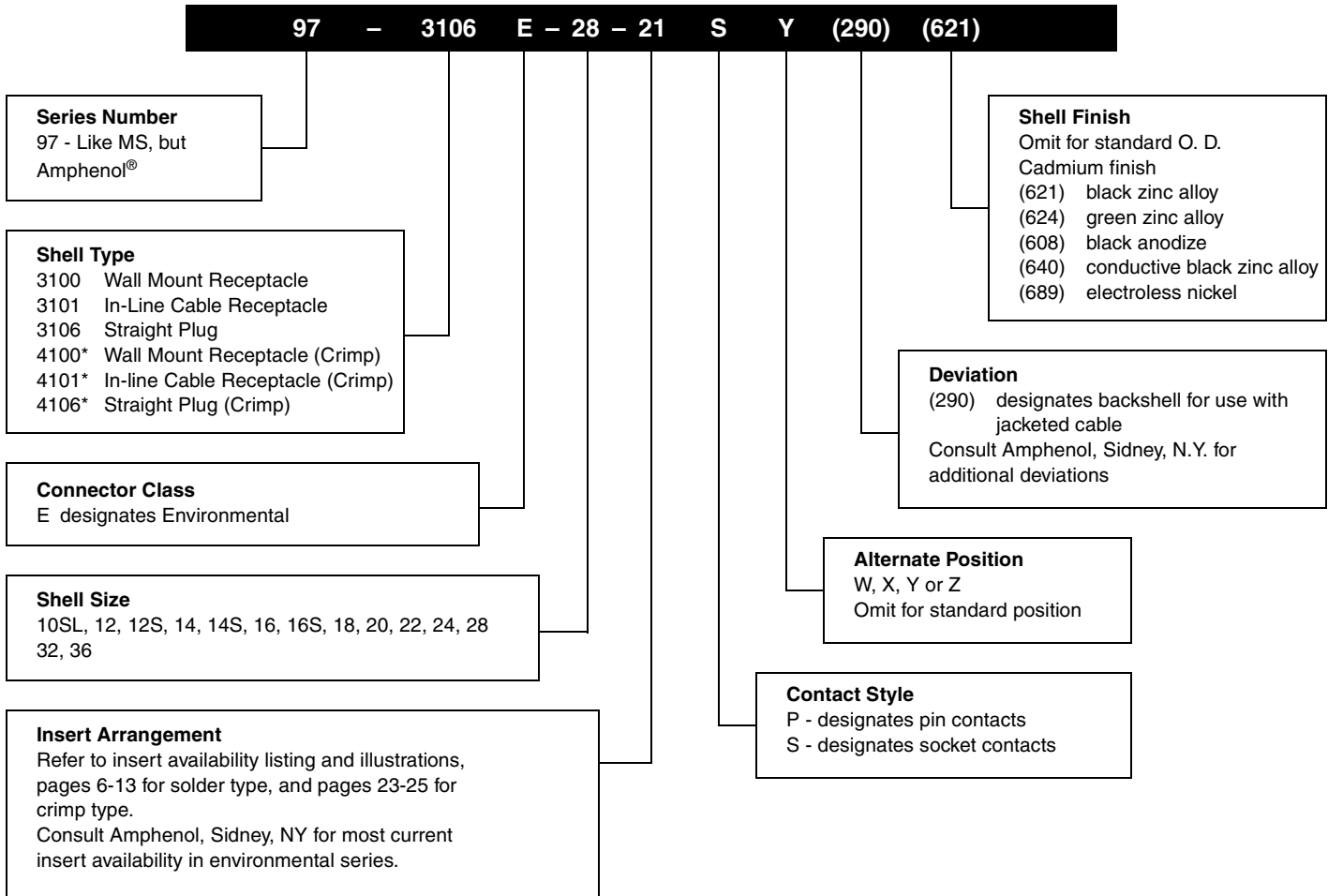

* 97E crimp is available for jacketed cable only, and must use the 290 deviation

L-2089 assembly instructions for 97E connectors are available upon request.

Amphenol® 97 Series Connectors with solder contacts



DESIGN CHARACTERISTICS

- Medium to heavy weight cylindrical
- Durable, field-proven design
- Environmental resistant
- Single key/keyway polarization
- Threaded coupling, hard dielectric inserts
- Operating temperatures from -55°C to $+125^{\circ}\text{C}$
- Cost effective
- Intermateable and intermountable with existing 97 Series and MIL-C-5015 connectors
- Underwriters Laboratories approved recognition File E115497
- Canadian Standards Association Certification File LR69183

CUSTOMER OPTIONS

- Solid or split shell construction
- Six shell styles
- 128 contact arrangements, from 1 to 52 circuits
- Alternate insert positioning
- High temperature and potting constructions
- Special plating finishes including black and green zinc alloy
- Optional gold plating on MS contacts
- Thermocouple arrangements available
- 97E available for jacketed cable and individual wire seal applications

Connector components are fabricated from high grade aluminum alloy, with a conductive cadmium plate finish and an olive drab chromate after-treatment. Some cable clamps are a zinc alloy with an olive drab/green chromate finish. See how to order page 21 for other finish variations.

Contacts are silver plated with pre-tinned solder cups. Optional gold over silver plating is also available. Inserts for solder style contacts are diallyl-phthalate.

Users should be aware that classes "A" and "B" of MIL-C-5015 have been cancelled, and these products are no longer qualified.

97 series solder type insert availability

| Insert Number | Total Contacts | Mechanical Spacing | | Service Rating | Contact Size | | | | |
|---------------|----------------|--------------------|------|----------------|--------------|---|---|------------------------|------------------------|
| | | Inches | mm | | 0 | 4 | 8 | 12 | 16 |
| 8S-1+ | 1 | 1/16 | 1.57 | INST. | | | | | 1 |
| 10SL-3 | 3 | 1/16 | 1.57 | A | | | | | 3 |
| 10SL-4 | 2 | 1/16 | 1.57 | A | | | | | 2 |
| 12SL-844+* | 4 | 1/16 | 1.57 | A | | | | | 4 |
| 12S-3 | 2 | 1/16 | 1.57 | A | | | | | 2 |
| 12-5+ | 1 | 1/8 | 3.18 | D | | | | 1 | |
| 12S-6+* | 2 | 1/16 | 1.57 | | | | | | 2 Thermo- couple |
| 14S-1† | 3 | 1/16 | 1.57 | A | | | | | 3 |
| 14S-2 | 4 | | | INST. | | | | | 4 |
| 14S-4+† | 1 | 1/8 | 3.18 | D | | | | | 1 |
| 14S-5 | 5 | | | INST. | | | | | 5 |
| 14S-6 | 6 | | | INST. | | | | | 6 |
| 14S-7 | 3 | 1/16 | 1.57 | A | | | | | 3 |
| 14S-9† | 2 | 1/16 | 1.57 | A | | | | | 2 |
| 16S-1 | 7 | 1/16 | 1.57 | A | | | | | 7 |
| 16S-4+ | 2 | 1/8 | 3.18 | D | | | | | 2 |
| 16S-5 | 3 | 1/16 | 1.57 | A | | | | | 3 |
| 16S-6+† | 3 | 1/16 | 1.57 | A | | | | | 3 |
| 16-7 | 3 | 1/16 | 1.57 | A | | | 1 | | 2 |
| 16S-8 | 5 | 1/16 | 1.57 | A | | | | | 5 |
| 16-9 | 4 | 1/16 | 1.57 | A | | | | 2 | 2 |
| 16-10 | 3 | 1/16 | 1.57 | A | | | | 3 | |
| 16-11+† | 2 | 1/16 | 1.57 | A | | | | 2 | |
| 16-12 | 1 | 1/16 | 1.57 | A | | | 1 | | |
| 16-13 | 2 | 1/16 | 1.57 | A | | | | 2 Thermo- couple | |
| 18-1 | 10 | 1/16 | 1.57 | A INST. | | | | | 4 6 |
| 18-3† | 2 | 1/8 | 3.18 | D | | | | 2 | |
| 18-4 | 4 | 1/8 | 3.18 | D | | | | | 4 |
| 18-5+ | 3 | 1/8 | 3.18 | D | | | | 2 | 1 |
| 18-8 | 8 | 1/16 | 1.57 | A | | | | 1 | 7 |
| 18-9† | 7 | | | INST. | | | | 2 | 5 |
| 18-10† | 4 | 1/16 | 1.57 | A | | | | 4 | |
| 18-11 | 5 | 1/16 | 1.57 | A | | | | 5 | |
| 18-12† | 6 | 1.16 | 1.57 | A | | | | | 6 |
| 18-13 | 4 | 1/16 | 1.57 | A | | | 1 | 3 | |
| 18-16 | 1 | 5/16 | 7.92 | C | | | | 1 | |
| 18-19† | 10 | 1/16 | 1.57 | A | | | | | 10 |
| 18-20 | 5 | 1/16 | 1.57 | A | | | | | 5 |
| 18-22† | 3 | 1/8 | 3.18 | D | | | | | 3 |
| 18-29+† | 5 | 1/16 | 1.57 | A | | | | | 5 |
| 18-420* | 1 | | | | | | | 1 Hi-Volt- age** | |
| 20-3† | 3 | 1/8 | 3.18 | D | | | | 3 | |

| Insert Number | Total Contacts | Mechanical Spacing | | Service Rating | Contact Size | | | | |
|---------------|----------------|--------------------|------|----------------|--------------|---|---|----|----|
| | | Inches | mm | | 0 | 4 | 8 | 12 | 16 |
| 20-4 | 4 | 1/8 | 3.18 | D | | | | 4 | |
| 20-6† | 3 | 1/8 | 3.18 | D | | | | | 3 |
| 20-7 | 8 | 1/8 | 3.18 | D | | | | | 4 |
| | | 1/16 | 1.57 | A | | | | | 4 |
| 20-8 | 6 | | | INST. | | | 2 | | 4 |
| 20-11† | 13 | | | INST. | | | | | 13 |
| 20-14 | 5 | 1/16 | 1.57 | A | | | 2 | 3 | |
| 20-15 | 7 | 1/16 | 1.57 | A | | | | 7 | |
| 20-16 | 9 | 1/16 | 1.57 | A | | | | 2 | 7 |
| 20-17 | 6 | 1/16 | 1.57 | A | | | | 5 | 1 |
| 20-18 | 9 | 1/16 | 1.57 | A | | | | 3 | 6 |
| 20-19† | 3 | 1/16 | 1.57 | A | | | 3 | | |
| 20-21 | 9 | 1/16 | 1.57 | A | | | | 1 | 8 |
| 20-23 | 2 | 1/16 | 1.57 | A | | | 2 | | |
| 20-24 | 4 | 1/16 | 1.57 | A | | | 2 | | 2 |
| 20-27 | 14 | 1/16 | 1.57 | A | | | | | 14 |
| 20-29 | 17 | 1/16 | 1.57 | A | | | | | 17 |
| 20-33 | 11 | 1/16 | 1.57 | A | | | | | 11 |
| 22-1† | 2 | 1/8 | 3.18 | D | | | 2 | | |
| 22-2 | 3 | 1/8 | 3.18 | D | | | 3 | | |
| 22-4† | 4 | 1/16 | 1.57 | A | | | 2 | 2 | |
| 22-5 | 6 | 1/8 | 3.18 | D | | | | 2 | 4 |
| 22-8† | 2 | 3/16 | 4.75 | E | | | | 2 | |
| 22-9 | 3 | 3/16 | 4.75 | E | | | | 3 | |
| 22-10 | 4 | 3/16 | 4.75 | E | | | | | 4 |
| 22-11 | 2 | 1/4 | 6.35 | B | | | | | 2 |
| 22-12 | 5 | 1/8 | 3.18 | D | | | 2 | | 3 |
| 22-13† | 5 | 1/8 | 3.18 | D | | | | | 1 |
| | | 1/16 | 1.57 | A | | | | 4 | |
| 22-14 | 19 | 1/16 | 1.57 | A | | | | | 19 |
| 22-15 | 6 | 3/16 | 4.75 | E | | | | | 1 |
| | | 1/16 | 1.57 | A | | | | 5 | |
| 22-16† | 9 | 1/16 | 1.57 | A | | | | 3 | 6 |
| 22-18 | 8 | 1/8 | 3.18 | D | | | | | 5 |
| | | 1/16 | 1.57 | A | | | | | 3 |
| 22-19 | 14 | 1/16 | 1.57 | A | | | | | 14 |
| 22-20† | 9 | 1/16 | 1.57 | A | | | | | 9 |
| 22-22 | 4 | 1/16 | 1.57 | A | | | 4 | | |
| 22-23 | 8 | 1/8 | 3.18 | D | | | | 1 | |
| | | 1/16 | 1.57 | A | | | | 7 | |

Not all insert arrangements are currently available for environmental individual wire seal. Consult Amphenol, Sidney, NY for availability.

† Inactive for new military design, but available for replacement or for non-military purposes.

* "MS" number not assigned. Use "97" prefix in place of "MS" in completing catalog number. See how to order, page 21.

** Hi-Voltage = 17KVAC/24KVDC

‡ Molded-in pin (MIP) insert requires (910) deviation. See how to order, pg. 21.

97 series solder type insert availability, cont.

| Insert Number | Total Contacts | Mechanical Spacing | | Service Rating | Contact Size | | | | |
|---------------|----------------|--------------------|------|----------------|--------------|---|---|----|----|
| | | Inches | mm | | 0 | 4 | 8 | 12 | 16 |
| 22-26* | 7 | 1/8 | 3.18 | | | | | 2 | 5 |
| 22-27 | 9 | 1/8 | 3.18 | D | | | 1 | | |
| | | 1/16 | 1.57 | A | | | | | 8 |
| 22-28† | 7 | 1/16 | 1.57 | A | | | | 7 | |
| 22-34 | 5 | 1/8 | 3.18 | D | | | | 3 | 2 |
| 24-2 | 7 | 1/8 | 3.18 | D | | | | 7 | |
| 24-5† | 16 | 1/16 | 1.57 | A | | | | | 16 |
| 24-6 | 8 | 1/8 | 3.18 | D | | | | 3 | |
| | | 1/16 | 1.57 | A | | | | 5 | |
| 24-7 | 16 | 1/16 | 1.57 | A | | | | 2 | 14 |
| 24-9† | 2 | 1/16 | 1.57 | A | | 2 | | | |
| 24-10 | 7 | 1/16 | 1.57 | A | | | 7 | | |
| 24-11 | 9 | 1/16 | 1.57 | A | | | 3 | 6 | |
| 24-12 | 5 | 1/16 | 1.57 | A | | 2 | | 3 | |
| 24-16 | 7 | 1/8 | 3.18 | D | | | 1 | | 3 |
| | | 1/16 | 1.57 | A | | | | 3 | |
| 24-19† | 12 | 1/16 | 1.57 | | | | | | 12 |
| 24-20‡ | 11 | 1/8 | 3.18 | D | | | | 2 | 9 |
| 24-21 | 10 | 1/8 | 3.18 | D | | | 1 | | 9 |
| 24-22‡ | 4 | 1/8 | 3.18 | D | | | 4 | | |
| 24-27 | 7 | 3/16 | 4.75 | E | | | | | 7 |
| 24-28 | 24 | 1/16 | 1.57 | INST. | | | | | 24 |
| 28-1 | 9 | 1/8 | 3.18 | D | | | 1 | 2 | |
| | | 1/16 | 1.57 | A | | | 2 | 4 | |
| 28-2 | 14 | 1/8 | 3.18 | D | | | | 2 | 12 |
| 28-3 | 3 | 3/16 | 4.75 | E | | | 3 | | |
| 28-6† | 3 | 1/8 | 3.18 | D | | 3 | | | |
| 28-8 | 12 | 1/16 | 1.57 | A | | | | | 9 |
| | | 1/8 | 3.18 | D | | | | | 1 |
| | | 3/16 | 4.75 | E | | | | 2 | |
| 28-9 | 12 | 1/8 | 3.18 | D | | | | 6 | 6 |
| 28-10 | 7 | 1/8 | 3.18 | D | | | | 1 | |
| | | 1/16 | 1.57 | A | | 2 | 2 | 2 | |
| 28-11 | 22 | 1/16 | 1.57 | A | | | | 4 | 18 |
| 28-12 | 26 | 1/16 | 1.57 | A | | | | | 26 |
| 28-15† | 35 | 1/16 | 1.57 | A | | | | | 35 |
| 28-16† | 20 | 1/16 | 1.57 | A | | | | | 20 |
| 28-17 | 15 | 1/4 | 6.35 | B | | | | | 1 |
| | | 1/8 | 3.18 | D | | | | | 3 |
| | | 1/16 | 1.57 | A | | | | | 11 |
| 28-18 | 12 | 5/16 | 7.92 | C | | | | | 1 |
| | | 1/8 | 3.18 | D | | | | | 5 |
| | | 1/16 | 1.57 | A | | | | | 2 |
| | | | | INST. | | | | | 4 |
| 28-19 | 10 | 1/4 | 6.35 | B | | | | | 2 |
| | | 1/8 | 3.18 | D | | | | | 2 |
| | | 1/16 | 1.57 | A | | | | 4 | 2 |

| Insert Number | Total Contacts | Mechanical Spacing | | Service Rating | Contact Size | | | | |
|---------------|----------------|--------------------|------|----------------|--------------|---|---|----|----|
| | | Inches | mm | | 0 | 4 | 8 | 12 | 16 |
| 28-20 | 14 | 1/16 | 1.57 | A | | | | 10 | 4 |
| 28-21 | 37 | 1/16 | 1.57 | A | | | | | 37 |
| 32-5† | 2 | 1/8 | 3.18 | D | 2 | | | | |
| 32-6 | 23 | 1/16 | 1.57 | A | | 2 | 3 | 2 | 16 |
| 32-7 | 35 | 1/16 | 1.57 | A | | | | 7 | 24 |
| | | | | INST. | | | | | 4 |
| 32-8† | 30 | 1/16 | 1.57 | A | | | | 6 | 24 |
| 32-13 | 23 | 1/8 | 3.18 | D | | | | 5 | 18 |
| 32-17 | 4 | 1/8 | 3.18 | D | | 4 | | | |
| 32-414 | 52 | 1/16 | 1.57 | A | | | | | 52 |
| 36-1† | 22 | 1/8 | 3.18 | D | | | | 4 | 18 |
| 36-5 | 4 | 1/16 | 1.57 | A | 4 | | | | |
| 36-6 | 6 | 1/16 | 1.57 | A | 2 | 4 | | | |
| 36-7 | 47 | 1/16 | 1.57 | A | | | | 7 | 40 |
| 36-8 | 47 | 1/16 | 1.57 | A | | | | 1 | 46 |
| 36-9 | 31 | 1/16 | 1.57 | A | | 1 | 2 | 14 | 14 |
| 36-10 | 48 | 1/16 | 1.57 | A | | | | | 48 |
| 36-15 | 35 | 1/16 | 1.57 | A | | | | | 34 |
| | | 1/8 | 3.18 | D | | | | | 1 |
| 36-403* | 52 | 1/16 | 1.57 | A | | | | | 52 |

Not all insert arrangements are currently available for environmental individual wire seal. Consult Amphenol, Sidney, NY for availability.

† Inactive for new military design, but available for replacement or for non-military purposes.

* "MS" number not assigned. Use "97" prefix in place of "MS" in completing catalog number. See how to order, page 21.

‡ Molded-in pin (MIP) insert requires (910) deviation. See how to order, pg. 21.

97 series solder type insert arrangements

Front view of pin insert or rear of socket insert illustrated.
 Items highlighted are most popular and most readily available.

NOTE: Not all insert arrangements are currently available for environmental, individual wire seal. Consult Amphenol, Sidney, NY for availability.

1 Contact

| | | | | | | |
|--------------------|-------|------|--------|-------|-------|-------------------------------|
| | | | | | | |
| Insert Arrangement | 8S-1 | 12-5 | 14S-4† | 16-12 | 18-16 | 18-420* |
| Contacts | 1#16 | 1#12 | 1#16 | 1#4 | 1#12 | 1#12 |
| Service Rating | INST. | D | D | A | C | High Voltage 17KVAC/24KVDC |

2 Contacts

| | | | | | | | |
|--------------------|--------|-------|--------------|--------|-------|--------|-------|
| | | | | | | | |
| Insert Arrangement | 10SL-4 | 12S-3 | 12S-6* | 14S-9† | 16S-4 | 16-11† | 16-13 |
| Contacts | 2#16 | 2#16 | 2#16 | 2#16 | 2#16 | 2#12 | 2#12 |
| Service Rating | A | A | Thermocouple | A | D | A | A |

| | | | | | | | |
|--------------------|-------|--------|-------|-------|-------|-------|-------|
| | | | | | | | |
| Insert Arrangement | 18-3† | 20-23† | 22-1† | 22-8† | 22-11 | 24-9† | 32-5† |
| Contacts | 2#12 | 2#8 | 2#8 | 2#12 | 2#16 | 2#4 | 2#0 |
| Service Rating | D | A | D | E | B | A | D |

3 Contacts

| | | | | | | | | | |
|--------------------|--------|--------|-------|--------|--------|-----------|-------|------------|--------|
| | | | | | | | | | |
| Insert Arrangement | 10SL-3 | 14S-1† | 14S-7 | 16S-5† | 16S-6† | 16-7 | 16-10 | 18-5 | 18-22† |
| Contacts | 3#16 | 3#16 | 3#16 | 3#16 | 3#16 | 1#8, 2#16 | 3#12 | 2#12, 1#16 | 3#16 |
| Service Rating | A | A | A | A | A | A | A | D | D |

| | | | | | | | |
|--------------------|-------|-------|--------|------|------|------|-------|
| | | | | | | | |
| Insert Arrangement | 20-3† | 20-6† | 20-19† | 22-2 | 22-9 | 28-3 | 28-6† |
| Contacts | 3#12 | 3#16 | 3#8 | 3#8 | 3#12 | 3#8 | 3#4 |
| Service Rating | D | D | A | D | E | E | D |

97 series solder type insert arrangements, cont.

Front view of pin insert or rear of socket insert illustrated.
 Items highlighted are most popular and most readily available.

NOTE: Not all insert arrangements are currently available for environmental, individual wire seal. Consult Amphenol, Sidney, NY for availability.

4 Contacts

| | | | | | | | |
|--------------------|---------------|-----------|------------|-------|--------|-----------|------|
| | | | | | | | |
| Insert Arrangement | 12SL-844* | 14S-2† | 16-9 | 18-4 | 18-10† | 18-13 | 20-4 |
| Contacts | 4#16 | 4#16 | 2#12, 2#16 | 4#16 | 4#12 | 3#12, 1#8 | 4#12 |
| Service Rating | 1/16" spacing | INST. | A | D | A | A | D |
| | | | | | | | |
| Insert Arrangement | 20-24 | 22-4† | 22-10 | 22-22 | 24-22 | 32-17 | 36-5 |
| Contacts | 2#8, 2#16 | 2#8, 2#12 | 4#16 | 4#8 | 4#8 | 4#4 | 4#0 |
| Service Rating | A | A | E | A | D | D | A |

5 Contacts

| | | | | | | |
|--------------------|-----------|-----------------------|------------|-----------|--------|-----------|
| | | | | | | |
| Insert Arrangement | 14S-5 | 16S-8 | 18-11 | 18-20† | 18-29† | 20-14 |
| Contacts | 5#16 | 5#16 | 5#12 | 5#16 | 5#16 | 3#12, 2#8 |
| Service Rating | INST. | A | A | A | A | A |
| | | | | | | |
| Insert Arrangement | 22-12 | 22-13† | 22-34† | 24-12 | | |
| Contacts | 2#8, 3#16 | 1#16, 4#12 | 3#12, 2#16 | 2#4, 3#12 | | |
| Service Rating | D | E = D; A, B, C, D = A | D | A | | |

SERVICE RATING

| | | INST. | A | D | E | B | C |
|------------------------|----------|-------|-----|------|------|------|------|
| Limiting Operating | DC | 250 | 700 | 1250 | 1750 | 2450 | 4200 |
| Voltagues at Sea Level | AC (rms) | 200 | 500 | 900 | 1250 | 1750 | 3000 |

See notes 1 and 2 under TEST CURRENT.

INST. service normally for low voltage and currents.

| Effective Creepage (nominal) | Inch | 1/16 | 1/8 | 3/16 | 1/4 | 5/16 | 1 |
|------------------------------|------|------|------|------|------|------|-------|
| | mm | 1.57 | 3.18 | 4.75 | 6.35 | 7.92 | 25.40 |
| Mechanical Spacing (nominal) | Inch | 1/16 | 1/8 | 3.16 | 1/4 | 5/16 | |
| | mm | 1.57 | 3.18 | 4.75 | 6.35 | 7.92 | |

TEST CURRENT

| Contact Size | 16 | 12 | 8 | 4 | 0 |
|--------------|----|----|----|----|-----|
| Amperes | 13 | 23 | 46 | 80 | 150 |

NOTE 1: Transients were not considered in calculating these values.

NOTE 2: Limiting operating voltages at 50,000 feet altitude are approximately 25% of the sea level values.

CONTACT LEGEND

| | | | | | | | |
|----|----|---|---|------|----|------------|-------|
| | | | | | | | |
| 16 | 12 | 8 | 4 | 0 | 16 | 12 | 16 12 |
| | | | | IRON | | CONSTANTAN | |

† Inactive for new military design, but available for replacement or for non-military purposes.

* "MS" number not assigned. Use "97" prefix in place of "MS" in completing catalog number. See how to order, page 21.

97 series solder type insert arrangements, cont.

Front view of pin insert or rear of socket insert illustrated.
 Items highlighted are most popular and most readily available.

NOTE: Not all insert arrangements are currently available for environmental, individual wire seal. Consult Amphenol, Sidney, NY for availability.

6 Contacts

| | | | | | | | |
|--------------------|-------|--------|-----------|------------|------------|--------------------------|----------|
| | | | | | | | |
| Insert Arrangement | 14S-6 | 18-12† | 20-8 | 20-17 | 22-5 | 22-15 | 36-6 |
| Contacts | 6#16 | 6#16 | 4#16, 2#8 | 5#12, 1#16 | 2#12, 4#16 | 5#12, 1#16 | 2#0, 4#4 |
| Service Rating | INST. | A | INST. | A | D | D = E; A, B, C, E, F = A | A |

7 Contacts

| | | | | | |
|--------------------|-------|------------|-------|--------------|--------|
| | | | | | |
| Insert Arrangement | 16S-1 | 18-9 | 20-15 | 22-26* | 22-28† |
| Contacts | 7#16 | 5#16, 2#12 | 7#12 | 2#12, 5#16 | 7#12 |
| Service Rating | A | INST. | A | 1/8" spacing | A |

| | | | | | |
|--------------------|------|-------|--------------------------------|-------|-----------------------|
| | | | | | |
| Insert Arrangement | 24-2 | 24-10 | 24-16 | 24-27 | 28-10 |
| Contacts | 7#12 | 7#8 | 3#16, 1#8, 3#12 | 7#16 | 3#12, 2#8, 2#4 |
| Service Rating | D | A | A, B, F, G = D; C, D, E = A | E | G = D; all others = A |

8 Contacts

| | | | | | |
|--------------------|------------|-----------------------------------|--------------------------------------|--------------------------|--------------------------------|
| | | | | | |
| Insert Arrangement | 18-8 | 20-7 | 22-18 | 22-23 | 24-6 |
| Contacts | 1#12, 7#16 | 8#16 | 8#16 | 8#12 | 8#12 |
| Service Rating | A | A, B, H, G = D; C, D, E, F = A | A, B, H, F, G = D; all others = A | H = D; all others = A | A, G, H = D; all others = A |

97 series solder type insert arrangements, cont.

Front view of pin insert or rear of socket insert illustrated.
Items highlighted are most popular and most readily available.

NOTE: Not all insert arrangements are currently available for environmental, individual wire seal. Consult Amphenol, Sidney, NY for availability.

9 Contacts

| | | | | | |
|--------------------|-----------------------|------------|-----------------------------|------------|--------|
| | | | | | |
| Insert Arrangement | 20-16 | 20-18 | 20-21 | 22-16† | 22-20† |
| Contacts | 7#16, 2#12 | 3#12, 6#16 | 1#12, 8#16 | 3#12, 6#16 | 9#16 |
| Service Rating | A | A | A | A | A |
| | | | | | |
| Insert Arrangement | 22-27 | 24-11 | 28-1 | | |
| Contacts | 1#8, 8#16 | 3#8, 6#12 | 3#8, 6#12 | | |
| Service Rating | J = D; all others = A | A | A, J, E = D; all others = A | | |

10 Contacts

| | | | | |
|--------------------|---------------------------------------|-------|-----------|---------------------------------------|
| | | | | |
| Insert Arrangement | 18-1 | 18-19 | 24-21 | 28-19 |
| Contacts | 10#16 | 10#16 | 1#8, 9#16 | 4#12, 6#16 |
| Service Rating | B, C, F, G = A; all others = INST. | A | D | H, M = B; A, B = D; all others = A |

11 Contacts

| | | |
|--------------------|-------|------------|
| | | |
| Insert Arrangement | 20-33 | 24-20 |
| Contacts | 11#16 | 2#12, 9#16 |
| Service Rating | A | D |

12 Contacts

| | | | | |
|--------------------|---------------|------------------------------------|------------|---|
| | | | | |
| Insert Arrangement | 24-19† | 28-8 | 28-9 | 28-18 |
| Contacts | 12#16 | 2#12, 10#16 | 6#12, 6#16 | 12#16 |
| Service Rating | 1/16" spacing | L, M = E; B = D; all others = A | D | M = C; A, B = A C, D, E, F = INST.; all others = D |

13 Contacts

| | |
|--------------------|--------|
| | |
| Insert Arrangement | 20-11† |
| Contacts | 13#16 |
| Service Rating | INST. |

† Inactive for new military design, but available for replacement or for non-military purposes.

* "MS" number not assigned. Use "97" prefix in place of "MS" in completing catalog number. See how to order, page 21.

See Service Rating and Test Current information on page 9.

CONTACT LEGEND

| | | | | |
|----|----|---|---|---|
| | | | | |
| 16 | 12 | 8 | 4 | 0 |

97 series solder type insert arrangements, cont.

Front view of pin insert or rear of socket insert illustrated.
Items highlighted are most popular and most readily available.

NOTE: Not all insert arrangements are currently available for environmental, individual wire seal. Consult Amphenol, Sidney, NY for availability.

14 Contacts

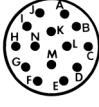
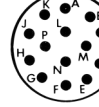
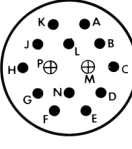
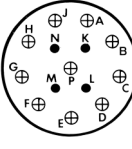
| | | | | |
|--------------------|---|---|---|--|
| |  |  |  |  |
| Insert Arrangement | 20-27 | 22-19 | 28-2 | 28-20 |
| Contacts | 14#16 | 14#16 | 2#12, 12#16 | 10#12, 4#16 |
| Service Rating | A | A | D | A |

15 Contacts

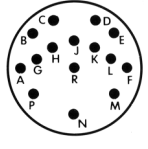
| | |
|--------------------|---|
| |  |
| Insert Arrangement | 28-17 |
| Contacts | 15#16 |
| Service Rating | R = B; M, N, P = D; all others = A |

16 Contacts

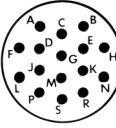
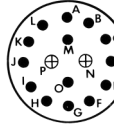
| | | |
|--------------------|--|--|
| |  |  |
| Insert Arrangement | 24-5† | 24-7 |
| Contacts | 16#16 | 2#12, 14#16 |
| Service Rating | A | A |

17 Contacts

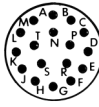
| | |
|--------------------|---|
| |  |
| Insert Arrangement | 20-29 |
| Contacts | 17#16 |
| Service Rating | A |

19 Contacts

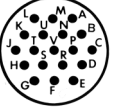
| | |
|--------------------|--|
| |  |
| Insert Arrangement | 22-14 |
| Contacts | 19#16 |
| Service Rating | A |

20 Contacts

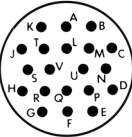
| | |
|--------------------|---|
| |  |
| Insert Arrangement | 28-16† |
| Contacts | 20#16 |
| Service Rating | A |

22 Contacts

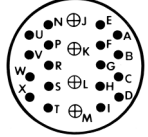
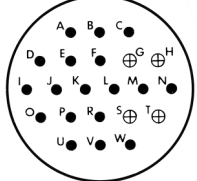
| | | |
|--------------------|---|---|
| |  |  |
| Insert Arrangement | 28-11 | 36-1† |
| Contacts | 4#12, 18#16 | 4#12, 18#16 |
| Service Rating | A | D |

23 Contacts

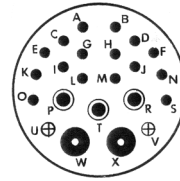
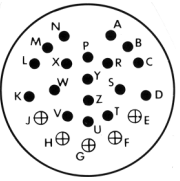
| | | |
|--------------------|---|---|
| |  |  |
| Insert Arrangement | 32-6 | 32-13 |
| Contacts | 2#4, 3#8, 2#12, 16#16 | 5#12, 18#16 |
| Service Rating | A | D |

24 Contacts

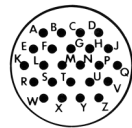
| | |
|--------------------|---|
| |  |
| Insert Arrangement | 24-28 |
| Contacts | 24#16 |
| Service Rating | INST. |

26 Contacts

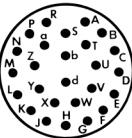
| | |
|--------------------|---|
| |  |
| Insert Arrangement | 28-12 |
| Contacts | 26#16 |
| Service Rating | A |

30 Contacts

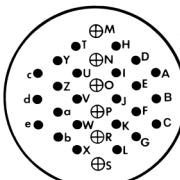
| | |
|--------------------|--|
| |  |
| Insert Arrangement | 32-8† |
| Contacts | 6#12, 24#16 |
| Service Rating | A |

31 Contacts

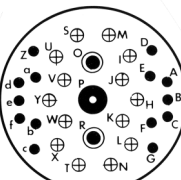
| | |
|--------------------|---|
| |  |
| Insert Arrangement | 36-9 |
| Contacts | 1#4, 2#8, 14#12, 14#16 |
| Service Rating | A |

97 series solder type insert arrangements, cont.

Front view of pin insert or rear of socket insert illustrated.
 Items highlighted are most popular and most readily available.

NOTE: Not all insert arrangements are currently available for environmental, individual wire seal. Consult Amphenol, Sidney, NY for availability.

35 Contacts

| | | | |
|--------------------|--------|---------------------------------------|-----------------------|
| | | | |
| Insert Arrangement | 28-15† | 32-7 | 36-15 |
| Contacts | 35#16 | 7#12, 28#16 | 35#16 |
| Service Rating | A | A, B, h, j = INST.; all others = A | m = D; all others = A |

37 Contacts

| | |
|--------------------|-------|
| | |
| Insert Arrangement | 28-21 |
| Contacts | 37#16 |
| Service Rating | A |

47 Contacts

| | | |
|--------------------|-------------|-------------|
| | | |
| Insert Arrangement | 36-7 | 36-8 |
| Contacts | 7#12, 40#16 | 1#12, 46#16 |
| Service Rating | A | A |

48 Contacts

| | |
|--------------------|-------|
| | |
| Insert Arrangement | 36-10 |
| Contacts | 48#16 |
| Service Rating | A |

52 Contacts

| | | |
|--------------------|---------|---------|
| | | |
| Insert Arrangement | 32-414* | 36-403* |
| Contacts | 52#16 | 52#16 |
| Service Rating | A | A |

† Inactive for new military design, but available for replacement or for non-military purposes.
 * "MS" number not assigned. Use "97" prefix in place of "MS" in completing catalog number. See how to order, page 21.
 See Service Rating and Test Current information on page 9.

CONTACT LEGEND

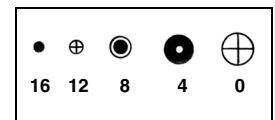

97 series solder type alternate insert positioning

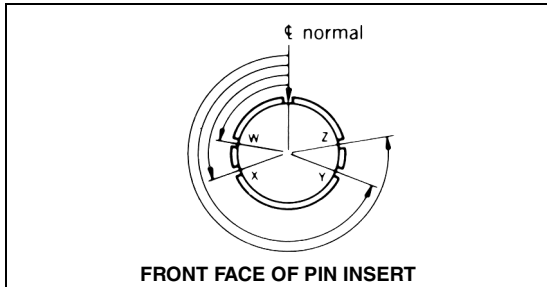

| Insert Arrangement | Degrees | | | |
|--------------------|---------|-----|-----|-----|
| | W | X | Y | Z |
| 12S-3 | 70 | 145 | 215 | 290 |
| 14S-2 | – | 120 | 240 | – |
| 14S-5 | – | 110 | – | – |
| 14S-7 | 90 | 180 | 270 | – |
| 14S-9 | 70 | 145 | 215 | 290 |
| 16S-1 | 80 | – | – | 280 |
| 16S-4 | 35 | 110 | 250 | 325 |
| 16S-5 | 70 | 145 | 215 | 290 |
| 16S-6 | 90 | 180 | 270 | – |
| 16-7 | 80 | 110 | 250 | 280 |
| 16S-8 | – | 170 | 265 | – |
| 16-9 | 35 | 110 | 250 | 325 |
| 16-10 | 90 | 180 | 270 | – |
| 16-11 | 35 | 110 | 250 | 325 |
| 16-13 | 35 | 110 | 250 | 325 |
| 18-1 | 70 | 145 | 215 | 290 |
| 18-3 | 35 | 110 | 250 | 325 |
| 18-4 | 35 | 110 | 250 | 325 |
| 18-5 | 80 | 110 | 250 | 280 |
| 18-8 | 70 | – | – | 290 |
| 18-9 | 80 | 110 | 250 | 280 |
| 18-10 | – | 120 | 240 | – |
| 18-11 | – | 170 | 265 | – |
| 18-12 | 80 | – | – | 280 |
| 18-13 | 80 | 110 | 250 | 280 |
| 18-19 | – | 120 | 240 | – |
| 18-20 | 90 | 180 | 270 | – |
| 18-22 | 70 | 145 | 215 | 290 |
| 18-29 | 90 | 180 | 270 | – |
| 20-3 | 70 | 145 | 215 | 290 |
| 20-4 | 45 | 110 | 250 | – |
| 20-6 | 70 | 145 | 215 | 290 |
| 20-7 | 80 | 110 | 250 | 280 |
| 20-8 | 80 | 110 | 250 | 280 |
| 20-14 | 80 | 110 | 250 | 280 |
| 20-15 | 80 | – | – | 280 |
| 20-16 | 80 | 110 | 250 | 280 |
| 20-17 | 90 | 180 | 270 | – |
| 20-18 | 35 | 110 | 250 | 325 |
| 20-19 | 90 | 180 | 270 | – |
| 20-21 | 35 | 110 | 250 | 325 |
| 20-23 | 35 | 110 | 250 | 325 |
| 20-24 | 35 | 110 | 250 | 325 |
| 20-27 | 35 | 110 | 250 | 325 |
| 20-29 | 80 | – | – | 280 |

| Insert Arrangement | Degrees | | | |
|--------------------|---------|------|------|------|
| | W | X | Y | Z |
| 22-1 | 35 | 110 | 250 | 325 |
| 22-2 | 70 | 145 | 215 | 290 |
| 22-4 | 35 | 110 | 250 | 325 |
| 22-5 | 35 | 110 | 250 | 325 |
| 22-8 | 35 | 110 | 250 | 325 |
| 22-9 | 70 | 145 | 215 | 290 |
| 22-10 | 35 | 110 | 250 | 325 |
| 22-11 | 35 | 110 | 250 | 325 |
| 22-12 | 80 | 110 | 250 | 280 |
| 22-13 | 35 | 110 | 250 | 325 |
| 22-14 | 80 | 110 | 250 | 280 |
| 22-15 | 80 | 110 | 250 | 280 |
| 22-16 | 80 | 110 | 250 | 280 |
| 22-18 | 80 | 110 | 250 | 280 |
| 22-19 | 80 | 110 | 250 | 280 |
| 22-20 | 35 | 110 | 250 | 325 |
| 22-22 | – | 110 | 250 | – |
| 22-23 | 35 | – | 250 | – |
| 22-27 | 80 | – | 250 | 280 |
| 22-28 | 80 | – | – | 280 |
| 22-34 | 80 | 110 | 250 | 280 |
| 24-2 | 80 | – | – | 280 |
| 24-5 | 80 | 110 | 250 | 280 |
| 24-6 | 80 | 110 | 250 | 280 |
| 24-7 | 80 | 110 | 250 | 280 |
| 24-9 | 35 | 110 | 250 | 325 |
| 24-10 | 80 | – | – | 280 |
| 24-11 | 35 | 110 | 250 | 325 |
| 24-12 | 80 | 110 | 250 | 280 |
| 24-16 | 80 | 110 | 250 | 280 |
| 24-20 | 80 | 110 | 250 | 280 |
| 24-21 | 80 | 110 | 250 | 280 |
| 24-22 | 45 | 110 | 250 | – |
| 24-27 | 80 | – | – | 280 |
| 24-28 | 80 | 110 | 250 | 280 |
| 28-1 | 80 | 110 | 250 | 280 |
| 28-2 | 35 | 110 | 250 | 325 |
| 28-3 | 70 | 145 | 215 | 290 |
| 28-6 | 70 | 145 | 215 | 290 |
| 28-8 | 80 | 110 | 250 | 280 |
| 28-9 | 80 | 110 | 250 | 280 |
| 28-10 | 80 | 110 | 250 | 280 |
| 28-11 | 80 | 110 | 250 | 280 |
| 28-12 | 90 | 180 | 270 | – |
| 28-15 | 80 | 110 | 250 | 280 |
| 28-16 | 80 | 110 | 250 | 280 |
| 28-17 | 80 | 110 | 250 | 280 |
| 28-18 | 70 | 145 | 215 | 290 |
| 28-19 | 80 | 110 | 250 | 280 |
| 28-20 | 80 | 110 | 250 | 280 |
| 28-21 | 80 | 110 | 250 | 280 |
| 32-5 | 35 | 110 | 250 | 325 |
| 32-6 | 80 | 110 | 250 | 280 |
| 32-7 | 80 | 125 | 235 | 280 |
| 32-8 | 80 | 125 | 235 | 280 |
| 32-13 | 80 | 110 | 250 | 280 |
| 32-17 | 45 | 110 | 250 | – |
| 32-414* | 80* | 110* | 250* | 280* |
| 36-1 | 80 | 110 | 250 | 280 |
| 36-5 | – | 120 | 240 | – |
| 36-6 | 35 | 110 | 250 | 325 |
| 36-7 | 80 | 110 | 250 | 280 |
| 36-8 | 80 | 110 | 250 | 280 |
| 36-9 | 80 | 125 | 235 | 280 |
| 36-10 | 80 | 125 | 235 | 280 |
| 36-15 | 60 | 125 | 245 | 305 |

*Rotates opposite above illustration.

97 series solder type receptacles

MS3100A wall mount receptacle

Solid shell construction is strong and conserves space. Includes integral polarizing key in front. Back shell is threaded for standard MS/AN fittings.

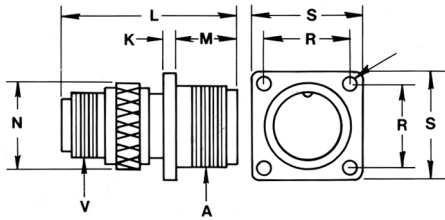

MS3101A cable receptacle

Solid shell construction is strong and conserves space. Includes integral polarizing key in front shell. Machined back shell is threaded for standard MS/AN fittings. Can be unscrewed for inspection or soldering.

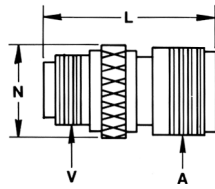

MS3102A box receptacle

Solid shell designed for open wiring. Mounts directly on chassis, equipment or panel. Includes internal polarized key in front shell.

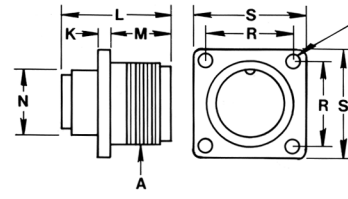

Mounting Holes
 .173 (4.394) DIA.
 FOR SIZES 32 AND 36
 .147 (3.734) DIA.
 FOR SIZES 24 AND 28
 .120 (3.048) DIA.
 FOR ALL OTHER SIZES

Panel Opening

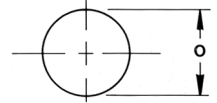

MS3100A and MS3101A

| Connector Size | A Coupling Thread | K Ref. | | L Max. | | M Ref. | | N Ref. | | O Ref. | | R Ref. | | S Ref. | | V Fitting Threads |
|----------------|-------------------|--------|------|---------|-------|--------|-------|--------|-------|--------|-------|---------|-------|--------|-------|-------------------|
| | | Inch | mm | Inch | mm | Inch | mm | Inch | mm | Inch | mm | Inch | mm | Inch | mm | |
| 8S | 1/2-28 | 5/64 | 1.98 | 1-1/4 | 31.75 | 9/16 | 14.27 | 17/32 | 13.49 | .562 | 14.27 | 19/32 | 15.06 | 7/8 | 22.23 | 1/2-28 |
| 10S | 5/8-24 | 5/64 | 1.98 | 1-5/16 | 33.32 | 9/16 | 14.27 | 5/8 | 15.88 | .688 | 17.48 | 23/32 | 18.24 | 1 | 25.40 | 1/2-28 |
| 10SL | 5/8-24 | 5/64 | 1.98 | 1-9/32 | 32.53 | 9/16 | 14.27 | 3/4 | 19.05 | .812 | 20.62 | 23/32 | 18.24 | 1 | 25.40 | 5/8-24 |
| 12S | 3/4-20 | 5/64 | 1.98 | 1-15/32 | 37.29 | 9/16 | 14.27 | 25/32 | 19.84 | .812 | 20.62 | 13/16 | 20.62 | 1-3/32 | 27.76 | 5/8-24 |
| 12 | 3/4-20 | 5/64 | 1.98 | 1-27/32 | 46.81 | 3/4 | 19.05 | 25/32 | 19.84 | .812 | 20.62 | 13/16 | 20.62 | 1-3/32 | 27.76 | 5/8-24 |
| 14S | 7/8-20 | 5/64 | 1.98 | 1-15/32 | 37.39 | 9/16 | 14.27 | 7/8 | 22.23 | .938 | 23.83 | 29/32 | 23.01 | 1-3/16 | 30.15 | 3/4-20 |
| 14 | 7/8-20 | 5/64 | 1.98 | 1-55/64 | 47.04 | 3/4 | 19.05 | 7/8 | 22.23 | .938 | 23.83 | 29/32 | 23.01 | 1-3/16 | 30.15 | 3/4-20 |
| 16S | 1 -20 | 5/64 | 1.98 | 1-15/32 | 37.39 | 9/16 | 14.27 | 1 | 25.40 | 1.062 | 26.97 | 31/32 | 24.59 | 1-9/32 | 32.54 | 7/8-20 |
| 16 | 1 -20 | 1/8 | 3.18 | 1-57/64 | 47.85 | 3/4 | 19.05 | 1 | 25.40 | 1.062 | 26.97 | 31/32 | 24.59 | 1-9/32 | 32.54 | 7/8-20 |
| 18 | 1-1/8-18 | 1/8 | 3.18 | 1-63/64 | 50.24 | 3/4 | 19.05 | 1-1/8 | 28.58 | 1.188 | 30.18 | 1-1/16 | 26.97 | 1-3/8 | 34.93 | 1 -20 |
| 20 | 1-1/4-18 | 1/8 | 3.18 | 1-57/64 | 47.85 | 3/4 | 19.05 | 1-1/4 | 31.75 | 1.312 | 33.32 | 1-5/32 | 29.36 | 1-1/2 | 38.10 | 1-3/16-18 |
| 22 | 1-3/8-18 | 1/8 | 3.18 | 1-63/64 | 50.24 | 3/4 | 19.05 | 1-3/8 | 34.93 | 1.438 | 36.53 | 1-1/4 | 31.75 | 1-5/8 | 39.67 | 1-3/16-18 |
| 24 | 1-1/2-18 | 1/8 | 3.18 | 2-1/4 | 57.15 | 13/16 | 20.62 | 1-1/2 | 38.10 | 1.562 | 36.67 | 1-3/8 | 34.43 | 1-3/4 | 44.45 | 1-7/16-18 |
| 28 | 1-3/4-18 | 1/8 | 3.18 | 2-1/4 | 57.15 | 13/16 | 20.62 | 1-3/4 | 44.45 | 1.812 | 46.02 | 1-9/16 | 39.67 | 2 | 50.80 | 1-7/16-18 |
| 32 | 2 -18 | 1/8 | 3.18 | 2-3/8 | 60.33 | 7/8 | 22.23 | 2-1/32 | 51.59 | 2.062 | 52.37 | 1-3/4 | 44.45 | 2-1/4 | 57.15 | 1-3/4-18 |
| 36 | 2-1/4-16 | 1/8 | 3.18 | 2-3/8 | 60.33 | 7/8 | 22.23 | 2-1/4 | 57.15 | 2.312 | 58.72 | 1-15/16 | 49.20 | 2-1/2 | 63.50 | 2 -18 |

MS3102A

| Connect or Size | A Coupling Thread | K Ref. | | L Max. | | M Ref. | | N Ref. | | O Ref. | | R Ref. | | S Ref. | |
|-----------------|-------------------|--------|------|---------|-------|--------|-------|---------|-------|--------|-------|---------|-------|--------|-------|
| | | Inch | mm | Inch | mm | Inch | mm | Inch | mm | Inch | mm | Inch | mm | Inch | mm |
| 8S | 1/2-28 | 5/64 | 1.98 | 55/64 | 21.82 | 9/16 | 14.27 | 7/16 | 11.10 | .562 | 14.27 | 19/32 | 15.06 | 7/8 | 22.23 |
| 10S | 5/8-24 | 5/64 | 1.98 | 55/64 | 21.82 | 9/16 | 14.27 | 1/2 | 12.70 | .688 | 17.48 | 23/32 | 18.24 | 1 | 25.40 |
| 10SL | 5/8-24 | 5/64 | 1.98 | 61/64 | 24.21 | 35/64 | 13.87 | 11/16 | 17.48 | .812 | 20.62 | 23/32 | 18.24 | 1 | 25.40 |
| 12S | 3/4-20 | 5/64 | 1.98 | 31/32 | 24.61 | 9/16 | 14.27 | 11/16 | 17.45 | .812 | 20.62 | 13/16 | 20.62 | 1-3/32 | 27.76 |
| 12 | 3/4-20 | 5/64 | 1.98 | 1-21/64 | 33.73 | 3/4 | 19.05 | 11/16 | 17.45 | .812 | 20.62 | 13/16 | 20.62 | 1-3/32 | 27.76 |
| 12SL | 3/4-20 | 5/64 | 1.98 | 27/32 | 21.44 | 35/64 | 13.87 | 11/16 | 17.45 | .938 | 23.83 | 13/16 | 20.62 | 1-3/32 | 27.76 |
| 14S | 7/8-20 | 5/64 | 1.98 | 61/64 | 24.21 | 9/16 | 14.27 | 3/4 | 19.05 | .938 | 23.83 | 29/32 | 23.01 | 1-3/16 | 30.15 |
| 14 | 7/8-20 | 5/64 | 1.98 | 1-11/32 | 34.14 | 3/4 | 19.05 | 3/4 | 19.05 | .938 | 23.83 | 29/32 | 23.01 | 1-3/16 | 30.15 |
| 16S | 1 -20 | 5/64 | 1.98 | 61/64 | 24.21 | 9/16 | 14.27 | 7/8 | 22.23 | 1.062 | 26.97 | 31/32 | 24.59 | 1-9/32 | 32.54 |
| 16 | 1 -20 | 1/8 | 3.18 | 1-3/8 | 34.92 | 3/4 | 19.05 | 7/8 | 22.23 | 1.062 | 26.97 | 31/32 | 24.59 | 1-9/32 | 32.54 |
| 18 | 1-1/8-18 | 1/8 | 3.18 | 1-3/8 | 34.92 | 3/4 | 19.05 | 1 | 25.40 | 1.188 | 30.18 | 1-1/16 | 26.97 | 1-3/8 | 34.93 |
| 20 | 1-1/4-18 | 1/8 | 3.18 | 1-3/8 | 34.92 | 3/4 | 19.05 | 1-1/8 | 28.58 | 1.312 | 33.32 | 1-5/32 | 29.36 | 1-1/2 | 38.10 |
| 22 | 1-3/8-18 | 1/8 | 3.18 | 1-3/8 | 34.92 | 3/4 | 19.05 | 1-1/4 | 31.75 | 1.438 | 36.53 | 1-1/4 | 31.75 | 1-5/8 | 41.28 |
| 24 | 1-1/2-18 | 1/8 | 3.18 | 1-3/8 | 34.92 | 13/16 | 20.62 | 1-3/8 | 34.93 | 1.562 | 39.67 | 1-3/8 | 34.93 | 1-3/4 | 44.45 |
| 28 | 1-3/4-18 | 1/8 | 3.18 | 1-3/8 | 34.92 | 13/16 | 20.62 | 1-5/8 | 41.28 | 1.812 | 46.02 | 1-9/16 | 39.67 | 2 | 50.80 |
| 32 | 2 -18 | 1/8 | 3.18 | 1-15/32 | 37.31 | 7/8 | 22.23 | 1-29/32 | 48.41 | 2.062 | 52.37 | 1-3/4 | 44.45 | 2-1/4 | 57.15 |
| 36 | 2-1/4-18 | 1/8 | 3.18 | 1-15/32 | 37.31 | 7/8 | 22.23 | 2-1/8 | 53.98 | 2.312 | 58.72 | 1-15/16 | 49.20 | 2-1/2 | 63.50 |

97 series solder type plugs with solid shells

MS3106A

| Connector Size | L Max. | | N Ref. | | Q Max. | | V Fitting Threads |
|----------------|---------|-------|--------|-------|---------|-------|-------------------|
| | Inch | mm | Inch | mm | Inch | mm | |
| 8S | 1-1/4 | 31.75 | 17/32 | 13.49 | 3/4 | 19.05 | 1/2-28 |
| 10S | 1-5/16 | 33.32 | 5/8 | 15.88 | 7/8 | 22.23 | 1/2-28 |
| 10SL | 1-3/8 | 34.93 | 3/4 | 19.05 | 7/8 | 22.23 | 5/8-24 |
| 12S | 1-7/16 | 36.50 | 25/32 | 19.84 | 1 | 25.40 | 5/8-24 |
| 12 | 1-7/8 | 47.63 | 25/32 | 19.84 | 1 | 25.40 | 5/8-24 |
| 12SL | 1-31/64 | 37.69 | 7/8 | 22.23 | 1 | 25.40 | 3/4-20 |
| 14S | 1-15/32 | 37.13 | 7/8 | 22.23 | 1-1/8 | 28.58 | 3/4-20 |
| 14 | 1-7/8 | 47.47 | 7/8 | 22.23 | 1-1/8 | 28.58 | 3/4-20 |
| 16S | 1-15/32 | 37.13 | 1 | 25.40 | 1-1/4 | 31.75 | 7/8-20 |
| 16 | 1-7/8 | 47.47 | 1 | 25.40 | 1-1/4 | 31.75 | 7/8-20 |
| 18 | 1-31/32 | 49.88 | 1-1/8 | 28.57 | 1-11/32 | 34.11 | 1 -20 |
| 20 | 1-7/8 | 47.50 | 1-1/4 | 31.75 | 1-15/32 | 37.29 | 1-3/16-18 |
| 22 | 1-31/32 | 49.88 | 1-3/8 | 34.93 | 1-19/32 | 40.46 | 1-3/16-18 |
| 24 | 2-1/4 | 57.15 | 1-1/2 | 38.10 | 1-23/32 | 43.64 | 1-7/16-18 |
| 28 | 2-1/4 | 57.15 | 1-3/4 | 44.45 | 1-31/32 | 49.99 | 1-7/16-18 |
| 32 | 2-3/8 | 60.33 | 2-1/32 | 51.59 | 2-7/32 | 56.34 | 1-3/4-18 |
| 36 | 2-3/8 | 60.33 | 2-1/4 | 57.15 | 2-15/32 | 62.69 | 2 -18 |

MS3106A straight plug

Sturdy, simple to assemble. Coupling ring machined from solid aluminum bar stock for high tensile strength. Mates with all types of MS receptacles. Front shell includes polarizing keyway. Back shell is threaded for standard MS/AN fittings.

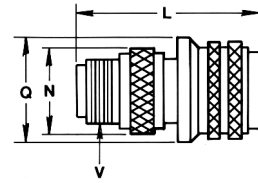

MS3107A

| Connector Size | L Max. | | N Ref. | | Q Max. | | V Fitting Threads |
|----------------|---------|-------|--------|-------|---------|-------|-------------------|
| | Inch | mm | Inch | mm | Inch | mm | |
| 10S | 1-5/16 | 33.32 | 5/8 | 15.88 | 7/8 | 22.23 | 1/2-28 |
| 10SL | 1-3/8 | 34.92 | 3/4 | 19.05 | 7/8 | 22.23 | 5/8-24 |
| 12S | 1-7/16 | 36.50 | 25/32 | 19.84 | 1 | 25.40 | 5/8-24 |
| 12 | 1-7/8 | 47.63 | 25/32 | 19.84 | 1 | 25.40 | 5/8-24 |
| 14S | 1-15/32 | 37.13 | 7/8 | 22.23 | 1-1/8 | 38.58 | 3/4-20 |
| 14 | 1-7/8 | 47.47 | 7/8 | 22.23 | 1-1/8 | 28.58 | 3/4-20 |
| 16S | 1-15/32 | 37.13 | 1 | 25.40 | 1-1/4 | 31.75 | 7/8-20 |
| 16 | 1-7/8 | 47.47 | 1 | 25.40 | 1-1/4 | 31.75 | 7/8-20 |
| 18 | 1-31/32 | 49.88 | 1-1/8 | 28.58 | 1-11/32 | 34.11 | 1 -20 |
| 20 | 1-7/8 | 47.50 | 1-1/4 | 31.75 | 1-15/32 | 37.29 | 1-3/16-18 |
| 22 | 1-31/32 | 49.88 | 1-3/8 | 34.93 | 1-19/32 | 40.46 | 1-3/16-18 |
| 24 | 2-1/4 | 57.15 | 1-1/2 | 38.10 | 1-23/32 | 43.64 | 1-7/16-18 |
| 28 | 2-1/4 | 57.15 | 1-3/4 | 44.45 | 1-31/32 | 49.99 | 1-7/16-18 |

MS3107A quick-disconnect plug

For fast connect/disconnect applications. Front shell has polarizing keyway. Mates with all types of MS receptacles. Back shell is threaded for standard MS/AN fittings.

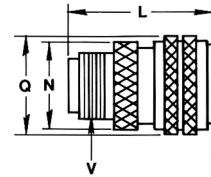

MS3108A

| Connector Size | L Ref. | | Q Max. | | U Ref. | | V Fitting Threads | Y Ref. | |
|----------------|---------|-------|---------|-------|--------|-------|-------------------|--------|-------|
| | Inch | mm | Inch | mm | Inch | mm | | Inch | mm |
| 10S | 1-1/4 | 31.75 | 7/8 | 22.23 | 7/8 | 22.23 | 1/2-28 | 25/32 | 19.84 |
| 10SL | 1-5/16 | 33.32 | 7/8 | 22.23 | 1 | 25.40 | 5/8-24 | 1-1/16 | 26.97 |
| 12S | 1-3/8 | 34.93 | 1 | 25.40 | 1 | 25.40 | 5/8-24 | 1-1/16 | 26.97 |
| 12SL | 1-3/8 | 34.93 | 1 | 25.40 | 1 | 25.40 | 3/4-20 | 1-1/16 | 26.97 |
| 12 | 1-13/64 | 30.56 | 1 | 25.40 | 1 | 25.40 | 5/8-24 | 1-1/16 | 26.97 |
| 14S | 1-3/8 | 34.93 | 1-1/8 | 28.58 | 1 | 25.40 | 3/4-20 | 1-1/16 | 26.97 |
| 14 | 1-13/16 | 46.02 | 1-1/8 | 28.58 | 1 | 25.40 | 3/4-20 | 1-1/16 | 26.97 |
| 16S | 1-1/2 | 38.10 | 1-1/4 | 31.75 | 1-1/8 | 28.58 | 7/8-20 | 1-5/16 | 33.32 |
| 16 | 1-15/16 | 49.20 | 1-1/4 | 31.75 | 1-1/8 | 28.58 | 7/8-20 | 1-5/16 | 33.32 |
| 18 | 1-15/16 | 49.20 | 1-11/32 | 34.11 | 1-1/8 | 28.58 | 1 -20 | 1-5/16 | 33.32 |
| 20 | 2-1/16 | 52.37 | 1-15/32 | 37.29 | 1-5/16 | 33.32 | 1-3/16-18 | 1-5/8 | 42.28 |
| 22 | 2-1/16 | 52.37 | 1-19/32 | 40.46 | 1-5/16 | 33.32 | 1-3/16-18 | 1-5/8 | 42.28 |
| 24 | 2-15/32 | 62.69 | 1-23/32 | 43.64 | 1-1/2 | 38.10 | 1-7/16-18 | 2 | 50.80 |
| 28 | 2-15/32 | 62.69 | 1-31/32 | 49.99 | 1-1/2 | 38.10 | 1-7/16-18 | 2 | 50.80 |

MS3108A angle plug

For use where space in front of panel or wall is at a premium. Swivel ring and plate combination allow cable take off at any angle relative to front shell polarizing key. Back shell is threaded for standard MS/AN fittings.

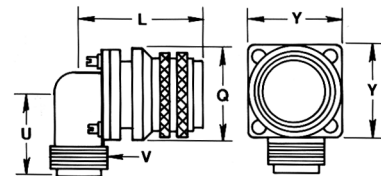

97 series solder type plugs with split shells

MS3106B

| Connector Size | L Max. | | Q Max. | | V Fitting Threads | Y Ref. | |
|----------------|---------|-------|---------|-------|-------------------|---------|-------|
| | Inch | mm | Inch | mm | | Inch | mm |
| 14S | 1-11/16 | 42.85 | 1-1/8 | 28.58 | 3/4-20 | 1-5/32 | 29.36 |
| 16S | 1-11/16 | 42.85 | 1-1/4 | 31.75 | 7/8-20 | 1-1/4 | 31.75 |
| 18 | 2-1/16 | 52.37 | 1-11/32 | 34.11 | 1 -20 | 1-41/64 | 41.66 |
| 20 | 2-1/8 | 53.98 | 1-15/32 | 37.29 | 1-3/16-18 | 1-13/16 | 46.02 |
| 22 | 2-1/8 | 53.98 | 1-19/32 | 40.46 | 1-3/16-18 | 1-15/16 | 49.20 |
| 24 | 2-9/32 | 57.94 | 1-23/32 | 43.64 | 1-7/16-18 | 2-1/16 | 52.37 |
| 28 | 2-9/32 | 57.94 | 1-31/32 | 49.99 | 1-3/4-18 | 2-5/16 | 58.72 |
| 32 | 2-5/16 | 58.72 | 2-7/32 | 56.34 | 1-3/4-18 | 2-19/32 | 65.86 |
| 36 | 2-11/32 | 59.51 | 2-15/32 | 62.69 | 2 -18 | 2-27/32 | 72.21 |

MS3106B straight plug

Used for unusual conduit applications where soldering and inspection is the prime requirement. Back shell is threaded for all standard MS/AN fittings.

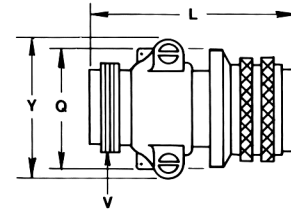

MS3107B

| Connector Size | L Max. | | Q Max. | | V Fitting Threads | Y Ref. | |
|----------------|---------|-------|---------|-------|-------------------|---------|-------|
| | Inch | mm | Inch | mm | | Inch | mm |
| 14S | 1-11/16 | 42.85 | 1-1/8 | 28.58 | 3/4-20 | 1-5/32 | 29.36 |
| 16S | 1-11/16 | 42.85 | 1-1/4 | 31.75 | 7/8-20 | 1-1/4 | 31.75 |
| 18 | 2-1/16 | 52.37 | 1-11/32 | 34.11 | 1 -20 | 1-41/64 | 41.66 |
| 20 | 2-1/8 | 53.99 | 1-15/32 | 37.29 | 1-3/16-18 | 1-13/16 | 46.02 |
| 22 | 2-1/8 | 53.99 | 1-19/32 | 40.46 | 1-3/16-18 | 1-15/16 | 49.20 |
| 24 | 2-9/32 | 57.94 | 1-23/32 | 43.64 | 1-7/16-18 | 2-1/16 | 52.37 |
| 28 | 2-9/32 | 57.94 | 1-31/32 | 49.99 | 1-7/16-18 | 2-5/16 | 58.72 |

MS3107B quick-disconnect plug

For fast connect/disconnect applications. Front shell has polarizing keyway. Mates with all types of MS receptacles. Back shell is threaded for standard MS/AN fittings.

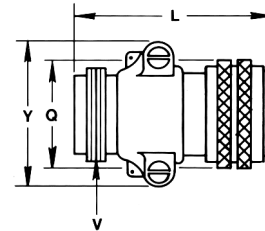

MS3108B

| Connector Size | L Ref. | | Q Max. | | U Ref. | | V Fitting Threads | X Ref. | |
|----------------|---------|-------|---------|-------|---------|-------|-------------------|---------|-------|
| | Inch | mm | Inch | mm | Inch | mm | | Inch | mm |
| 10S | 1-3/8 | 34.93 | 7/8 | 22.23 | 7/8 | 22.23 | 1/2-28 | | |
| 10SL | 1-1/2 | 38.10 | 7/8 | 22.23 | 1 | 25.40 | 5/8-24 | | |
| 12S | 1-9/16 | 39.67 | 1 | 25.40 | 1 | 25.40 | 5/8-24 | 1/2 | 12.70 |
| 12 | 1-7/8 | 47.63 | 1 | 25.40 | 1 | 25.40 | 5/8-24 | 1/2 | 12.70 |
| 14S | 1-23/32 | 43.64 | 1-1/8 | 28.58 | 1-1/16 | 26.97 | 3/4-20 | 21/32 | 16.66 |
| 14 | 1-15/16 | 49.20 | 1-1/8 | 28.58 | 1-1/16 | 26.97 | 3/4-20 | 21/32 | 16.66 |
| 16S | 1-3/4 | 44.45 | 1-1/4 | 31.75 | 1-1/8 | 28.58 | 7/8-20 | 1-1/2 | 38.10 |
| 16 | 2-1/8 | 53.98 | 1-1/4 | 31.75 | 1-1/8 | 28.58 | 7/8-20 | 1-1/2 | 38.10 |
| 18 | 2-5/32 | 54.75 | 1-11/32 | 34.11 | 1-3/16 | 30.15 | 1 -20 | 1-41/64 | 41.66 |
| 20 | 2-3/8 | 60.33 | 1-15/32 | 37.29 | 1-5/16 | 33.32 | 1-3/16-18 | 1-13/16 | 46.02 |
| 22 | 2-13/32 | 61.11 | 1-19/32 | 40.46 | 1-5/16 | 33.32 | 1-3/16-18 | 1-15/16 | 49.20 |
| 24 | 2-5/8 | 66.68 | 1-23/32 | 43.64 | 1-7/16 | 36.50 | 1-7/16-18 | 2-1/16 | 52.37 |
| 28 | 2-5/8 | 66.68 | 1-31/32 | 49.99 | 1-7/16 | 36.50 | 1-7/16-18 | 2-5/16 | 58.72 |
| 32 | 2-13/16 | 71.42 | 2-7/32 | 56.34 | 1-3/4 | 44.45 | 1-3/4-18 | 2-19/32 | 65.86 |
| 36 | 2-27/32 | 72.21 | 2-15/32 | 62.69 | 1-15/16 | 49.20 | 2 -18 | 2-27/32 | 72.21 |

MS3108B angle plug

Lightweight, roomy cavity, split longitudinally for convenient solder or inspection. Front shell is keyed to allow the 90° angle housing to be rotated and locked at any 45° increment.

Sizes 10S thru 14

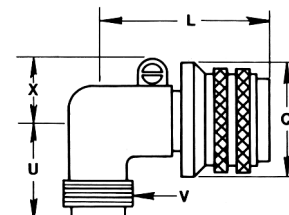

Sizes 16S thru 40

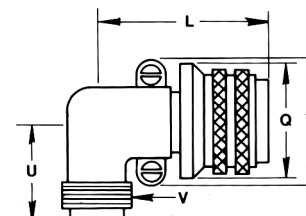

97 series solder type availability and weight reference

| Insert Number | Wall Receptacles MS3100 | Cable Receptacles MS3101 | Box Receptacles MS3102 | Straight Plugs MS3106 | | Quick Disconnect Plugs MS3107 | | Angle Plugs MS3108 | | Total Contacts |
|---------------|-------------------------|--------------------------|------------------------|-----------------------|-------------|-------------------------------|-------------|--------------------|-------------|----------------|
| | Solid Shell | Solid Shell | Solid Shell | Solid Shell | Split Shell | Solid Shell | Split Shell | Solid Shell | Split Shell | |
| | A | A | A | A | B | A | B | A | B | |
| 8S-1 | .02 | .01 | .01 | .02 | | | | | | 1 |
| 10SL-3P | .03 | .03 | .02 | | | | | | | 3 |
| 10SL-3S | | | | .03 | | .03 | | .06 | .05 | 3 |
| 10SL-4P† | .02 | .02 | .02 | | | | | | | 2 |
| 10SL-4S† | | | | .03 | | .03 | | .06 | .05 | 2 |
| 12S-3 | .04 | .03 | .03 | .03 | | .03 | | .07 | .07 | 2 |
| 12-5 | .05 | .04 | .03 | .06 | | .06 | | .09 | .08 | 1 |
| 12S-6* | .04 | .03 | .03 | .04 | | .04 | | .07 | .08 | 2 |
| 12SL-844P* | | | .03 | | | | | | | 4 |
| 12SL-844S* | | | | .05 | | .06 | | .08 | | 4 |
| 14S-1† | .05 | .04 | .03 | .06 | .06 | .06 | .06 | .08 | .08 | 3 |
| 14S-2 | .05 | .04 | .03 | .06 | .06 | .06 | .06 | .08 | .08 | 4 |
| 14S-4† | .05 | .04 | .03 | .06 | .06 | .06 | .06 | .08 | .08 | 1 |
| 14S-5 | .05 | .04 | .04 | .06 | .06 | .06 | .06 | .08 | .08 | 5 |
| 14S-6 | .05 | .04 | .04 | .06 | .06 | .06 | .06 | .08 | .08 | 6 |
| 14S-7 | .05 | .04 | .03 | .06 | .06 | .06 | .06 | .08 | .08 | 3 |
| 14S-9† | .05 | .04 | .03 | .06 | .06 | .07 | .06 | .08 | .08 | 2 |
| 16S-1 | .06 | .05 | .05 | .07 | .07 | .08 | .07 | .14 | .11 | 7 |
| 16S-4 | .06 | .05 | .04 | .07 | .07 | .07 | .07 | .12 | .10 | 2 |
| 16S-5† | .06 | .05 | .04 | .07 | .07 | .07 | .07 | .12 | .10 | 3 |
| 16S-6† | .06 | .05 | .04 | .07 | .07 | .09 | .07 | .12 | .10 | 3 |
| 16-7 | .08 | .08 | .07 | .09 | | .07 | | .15 | .14 | 3 |
| 16S-8 | .06 | .05 | .04 | .07 | .07 | .09 | .07 | .12 | .10 | 5 |
| 16-9 | .08 | .07 | | .09 | | .09 | .10 | .12 | .13 | 4 |
| 16-10 | .08 | .08 | .07 | .09 | | .09 | | .15 | .14 | 3 |
| 16-11† | .08 | .07 | .07 | .09 | | .11 | | .14 | .13 | 2 |
| 16-12 | .10 | .09 | .08 | .11 | | .08 | | .16 | .15 | 1 |
| 16-13 | .07 | .07 | .06 | .08 | | .11 | | .14 | .13 | 2 |
| 18-1 | .10 | .10 | .08 | .11 | .13 | .12 | .13 | .16 | .15 | 10 |
| 18-3† | .10 | .10 | .08 | .12 | .13 | .11 | .13 | .16 | .15 | 2 |
| 18-4 | .09 | .09 | .07 | .11 | .13 | .12 | .13 | .16 | .15 | 4 |
| 18-5 | .10 | .10 | .08 | .12 | .13 | .13 | .13 | .16 | .15 | 3 |
| 18-8 | .10 | .10 | .08 | .12 | .14 | .12 | .14 | .16 | .15 | 8 |
| 18-9 | .11 | .10 | .09 | .12 | .14 | .13 | .14 | .17 | .16 | 7 |
| 18-10† | .11 | | .09 | .13 | .14 | .13 | .14 | .17 | .16 | 4 |
| 18-11 | .11 | .11 | .09 | .13 | .15 | .11 | .15 | .18 | .17 | 5 |
| 18-12† | .10 | .09 | .08 | .11 | .13 | .13 | .13 | .16 | .15 | 6 |
| 18-13 | .12 | .12 | .10 | .13 | .15 | .13 | .15 | .18 | .17 | 4 |
| 18-16 | .09 | .09 | .07 | .11 | .13 | .11 | .13 | .15 | .14 | 1 |
| 18-19† | .10 | .10 | .08 | .11 | .13 | .11 | .13 | .16 | .15 | 10 |
| 18-20† | .09 | .09 | .07 | .11 | .13 | .11 | .13 | .15 | .15 | 5 |
| 18-22† | .09 | .09 | .07 | .11 | .13 | | .13 | .16 | .15 | 3 |
| 18-29† | .10 | | .08 | .11 | .13 | .11 | .13 | .16 | .15 | 5 |
| 18-420†* | .10 | .10 | .08 | .12 | .13 | .12 | .13 | .16 | .16 | 1 |
| 20-3† | .14 | .13 | .10 | .15 | .16 | .15 | .16 | .24 | .19 | 3 |

Where no weight is shown, insert is not available in that shell type.

† Inactive for new military design, but available for replacement or for non-military purposes.

* "MS" number not assigned. Use "97" prefix in place of "MS" in completing catalog number.

Weights are for connectors with socket contacts. Connectors with pin contacts weigh slightly less. If a weight appears in the column, the shell is available. Weight is shown in lbs.

97 series solder type availability and weight reference, cont.

| Insert Number | Wall Receptacles MS3100 | Cable Receptacles MS3101 | Box Receptacles MS3102 | Straight Plugs MS3106 | | Quick Disconnect Plugs MS3107 | | Angle Plugs MS3108 | | Total Contacts |
|---------------|-------------------------|--------------------------|------------------------|-----------------------|-------------|-------------------------------|-------------|--------------------|-------------|----------------|
| | Solid Shell | Solid Shell | Solid Shell | Solid Shell | Split Shell | Solid Shell | Split Shell | Solid Shell | Split Shell | |
| | A | A | A | A | B | A | B | A | B | |
| 20-4 | .14 | .13 | .10 | .15 | .16 | .15 | .16 | .24 | .19 | 4 |
| 20-6† | .12 | .11 | .09 | .13 | .15 | .14 | .15 | .23 | .18 | 3 |
| 20-7 | .13 | .12 | .09 | .14 | .15 | .14 | .15 | .23 | .18 | 8 |
| 20-8 | .15 | .14 | .12 | .16 | .18 | .16 | .18 | .26 | .20 | 6 |
| 20-11† | .14 | .13 | .11 | .15 | .17 | .15 | .17 | .25 | .20 | 13 |
| 20-14 | .16 | .15 | .13 | .17 | .19 | .17 | .19 | .27 | .21 | 5 |
| 20-15 | .15 | .14 | .12 | .16 | .18 | .16 | .18 | .26 | .21 | 7 |
| 20-16 | .14 | .13 | .10 | .15 | .16 | .15 | .16 | .24 | .19 | 9 |
| 20-17 | .15 | .14 | .11 | .16 | .17 | .16 | .17 | .25 | .20 | 6 |
| 20-18 | .14 | .13 | .11 | .15 | .17 | .15 | .17 | .25 | .19 | 9 |
| 20-19† | .16 | .15 | .13 | .17 | .19 | .17 | .19 | .27 | .21 | 3 |
| 20-21 | .13 | .12 | .10 | .14 | .16 | .14 | .16 | .24 | .19 | 9 |
| 20-23† | .15 | .14 | .11 | .16 | .17 | .16 | .17 | .25 | .20 | 2 |
| 20-24 | .15 | .14 | .11 | .16 | .17 | .16 | .17 | .25 | .20 | 4 |
| 20-27 | .13 | .12 | .10 | .14 | .16 | .14 | .16 | .24 | .19 | 14 |
| 20-29 | .14 | .13 | .11 | .15 | .17 | .15 | .17 | .25 | .20 | 17 |
| 20-33 | .13 | .12 | .09 | .14 | .18 | .18 | .18 | .23 | .18 | 11 |
| 22-1† | .16 | .16 | .13 | .18 | .19 | .18 | .19 | .27 | .23 | 2 |
| 22-2 | .17 | .17 | .14 | .19 | .20 | .19 | .20 | .29 | .24 | 3 |
| 22-4† | .21 | .17 | .14 | .19 | .20 | .19 | .20 | .28 | .23 | 4 |
| 22-5 | .15 | .14 | .12 | .17 | .18 | .17 | .18 | .26 | .21 | 6 |
| 22-8† | .15 | .14 | .11 | .16 | .18 | .16 | .18 | .26 | .21 | 2 |
| 22-9 | .15 | .15 | .12 | .17 | .18 | .17 | .18 | .26 | .21 | 3 |
| 22-10 | .14 | .13 | .10 | .15 | .17 | .15 | .17 | .25 | .20 | 4 |
| 22-11 | .14 | .13 | .10 | .15 | .17 | .15 | .17 | .25 | .20 | 2 |
| 22-12 | .16 | .16 | .13 | .18 | .19 | .18 | .19 | .27 | .23 | 5 |
| 22-13† | .16 | .15 | .12 | .17 | .18 | .17 | .18 | .27 | .22 | 5 |
| 22-14 | .15 | .14 | .11 | .16 | .18 | .16 | .18 | .26 | .21 | 19 |
| 22-15 | .16 | .14 | .13 | .17 | .19 | .17 | .19 | .27 | .22 | 6 |
| 22-16† | .16 | .15 | .12 | .17 | .18 | .17 | .18 | .27 | .22 | 9 |
| 22-18 | .14 | .13 | .10 | .15 | .17 | .15 | .17 | .25 | .20 | 8 |
| 22-19 | .15 | .14 | .11 | .16 | .18 | .16 | .18 | .26 | .21 | 14 |
| 22-20† | .14 | .14 | .11 | .16 | .17 | .16 | .17 | .25 | .21 | 9 |
| 22-22 | .19 | .19 | .16 | .21 | .26 | .21 | .22 | .30 | .25 | 4 |
| 22-23 | .17 | .16 | .13 | .18 | .20 | .18 | .20 | .28 | .23 | 8 |
| 22-26† | .15 | .14 | .11 | | | | | | .19 | 7 |
| 22-27 | .15 | .15 | .12 | .17 | .18 | .17 | .18 | .27 | .22 | 9 |
| 22-28† | .17 | .16 | .13 | .18 | .20 | .18 | .20 | .28 | .23 | 7 |
| 22-34† | .15 | .15 | .12 | .17 | .18 | .17 | .18 | .26 | .22 | 5 |
| 24-2 | .20 | .19 | .16 | .22 | .24 | .22 | .24 | .39 | .29 | 7 |
| 24-5† | .18 | .17 | .14 | .20 | .22 | .20 | .22 | .37 | .27 | 16 |
| 24-6 | .20 | .19 | .16 | .22 | .24 | .22 | .27 | .39 | .29 | 8 |
| 24-7 | .19 | .18 | .14 | .21 | .23 | .21 | .23 | .38 | .27 | 16 |
| 24-9† | .22 | .21 | .17 | .24 | .25 | .24 | .25 | .41 | .30 | 2 |
| 24-10 | .26 | .25 | .21 | .28 | .30 | .28 | .30 | .45 | .34 | 7 |

Where no weight is shown, insert is not available in that shell type.

† Inactive for new military design, but available for replacement or for non-military purposes.

* "MS" number not assigned. Use "97" prefix in place of "MS" in completing catalog number.

Weights are for connectors with socket contacts.

Connectors with pin contacts weigh slightly less.

If a weight appears in the column, the shell is available.

Weight is shown in lbs.

97 series solder type

availability and weight reference, cont.

| Insert Number | Wall Receptacles MS3100 | Cable Receptacles MS3101 | Box Receptacles MS3102 | Straight Plugs MS3106 | | Quick Disconnect Plugs MS3107 | | Angle Plugs MS3108 | | Total Contacts |
|---------------|-------------------------|--------------------------|------------------------|-----------------------|-------------|-------------------------------|-------------|--------------------|-------------|----------------|
| | Solid Shell | Solid Shell | Solid Shell | Solid Shell | Split Shell | Solid Shell | Split Shell | Solid Shell | Split Shell | |
| | A | A | A | A | B | A | B | A | B | |
| 24-11 | .24 | .22 | .19 | .26 | .27 | .26 | .27 | .43 | .32 | 9 |
| 24-12 | .23 | .22 | .19 | .25 | .27 | .25 | .27 | .42 | .32 | 5 |
| 24-16 | .20 | .19 | .15 | .22 | .24 | .22 | .24 | .39 | .28 | 7 |
| 24-19† | .18 | .17 | .13 | .20 | .22 | | | .37 | .36 | 12 |
| 24-20 | .19 | .17 | .14 | .21 | .22 | .21 | .22 | .38 | .27 | 11 |
| 24-21 | .19 | .17 | .14 | .21 | .23 | .21 | .23 | .38 | .27 | 10 |
| 24-22 | .22 | .21 | .18 | .24 | .26 | .24 | .26 | .41 | .30 | 4 |
| 24-27 | .17 | .16 | .13 | .20 | .21 | .20 | .21 | .36 | .26 | 7 |
| 24-28 | .19 | .18 | .14 | .21 | .22 | .21 | .22 | .38 | .27 | 24 |
| 28-1 | .29 | .27 | .24 | .30 | .32 | .30 | .32 | .44 | .36 | 9 |
| 28-2 | .24 | .22 | .19 | .25 | .27 | .25 | .27 | .40 | .32 | 14 |
| 28-3 | .26 | .24 | .21 | .28 | .30 | .28 | .30 | .42 | .34 | 3 |
| 28-6† | .30 | .28 | .25 | .31 | .33 | .31 | .33 | .45 | .38 | 3 |
| 28-8 | .23 | .22 | .18 | .25 | .27 | .25 | .27 | .39 | .31 | 12 |
| 28-9 | .25 | .24 | .20 | .27 | .29 | .27 | .29 | .41 | .33 | 12 |
| 28-10 | .31 | .29 | .26 | .33 | .35 | .33 | .35 | .47 | .39 | 7 |
| 28-11 | .25 | .24 | .20 | .27 | .29 | .27 | .29 | .41 | .33 | 22 |
| 28-12 | .24 | .22 | .19 | .26 | .28 | .26 | .28 | .40 | .32 | 26 |
| 28-15† | .25 | .23 | .20 | .26 | .28 | .26 | .28 | .40 | .32 | 35 |
| 28-16† | .24 | .22 | .19 | .25 | .27 | .25 | .27 | .39 | .31 | 20 |
| 28-17 | .23 | .22 | .18 | .25 | .27 | .25 | .27 | .39 | .31 | 15 |
| 28-18 | .23 | .22 | .18 | .25 | .27 | .25 | .27 | .39 | .31 | 12 |
| 28-19 | .24 | .22 | .19 | .26 | .28 | .26 | .28 | .40 | .32 | 10 |
| 28-20 | .27 | .25 | .22 | .29 | .31 | .29 | .31 | .43 | .35 | 14 |
| 28-21 | .25 | .23 | .20 | .26 | .28 | .26 | .28 | .40 | .32 | 37 |
| 32-5† | .36 | .35 | .32 | .38 | .40 | | | | .48 | 2 |
| 32-6 | .39 | .38 | .35 | .41 | .43 | | | | .51 | 23 |
| 32-7 | .33 | .33 | .29 | .36 | .38 | | | | .45 | 35 |
| 32-8† | .32 | .32 | .29 | .35 | .37 | | | | .44 | 30 |
| 32-13 | .32 | .31 | .28 | .34 | .36 | | | | .44 | 23 |
| 32-17 | .37 | .37 | .34 | .40 | .42 | | | | .49 | 4 |
| 32-414† | .35 | .35 | .31 | .38 | .40 | | | | .48 | 52 |
| 36-1† | .41 | .39 | .34 | .41 | .43 | | | | .52 | 22 |
| 36-5 | .54 | .52 | .47 | .54 | .56 | | | | .65 | 4 |
| 36-6 | .55 | .53 | .49 | .55 | .57 | | | | .67 | 6 |
| 36-7 | .44 | .41 | .37 | .44 | .45 | | | | .55 | 47 |
| 36-8 | .40 | .38 | .34 | .41 | .42 | | | | .52 | 47 |
| 36-9 | .50 | .47 | .43 | .50 | .51 | | | | .61 | 31 |
| 36-10 | .41 | .39 | .34 | .41 | .43 | | | | .53 | 48 |
| 36-15 | .40 | .37 | .38 | .40 | .41 | | | | .51 | 35 |
| 36-403†* | .40 | .36 | .33 | .40 | .41 | | | | .51 | 52 |

Where no weight is shown, insert is not available in that shell type.

† Inactive for new military design, but available for replacement or for non-military purposes.

* "MS" number not assigned. Use "97" prefix in place of "MS" in completing catalog number.

Weights are for connectors with socket contacts. Connectors with pin contacts weigh slightly less. If a weight appears in the column, the shell is available. Weight is shown in lbs.

97 series solder type

how to order

Example of part number for non-environmental solder type connectors is given below.
 (For environmental solder type connectors, see how to order on page 4).

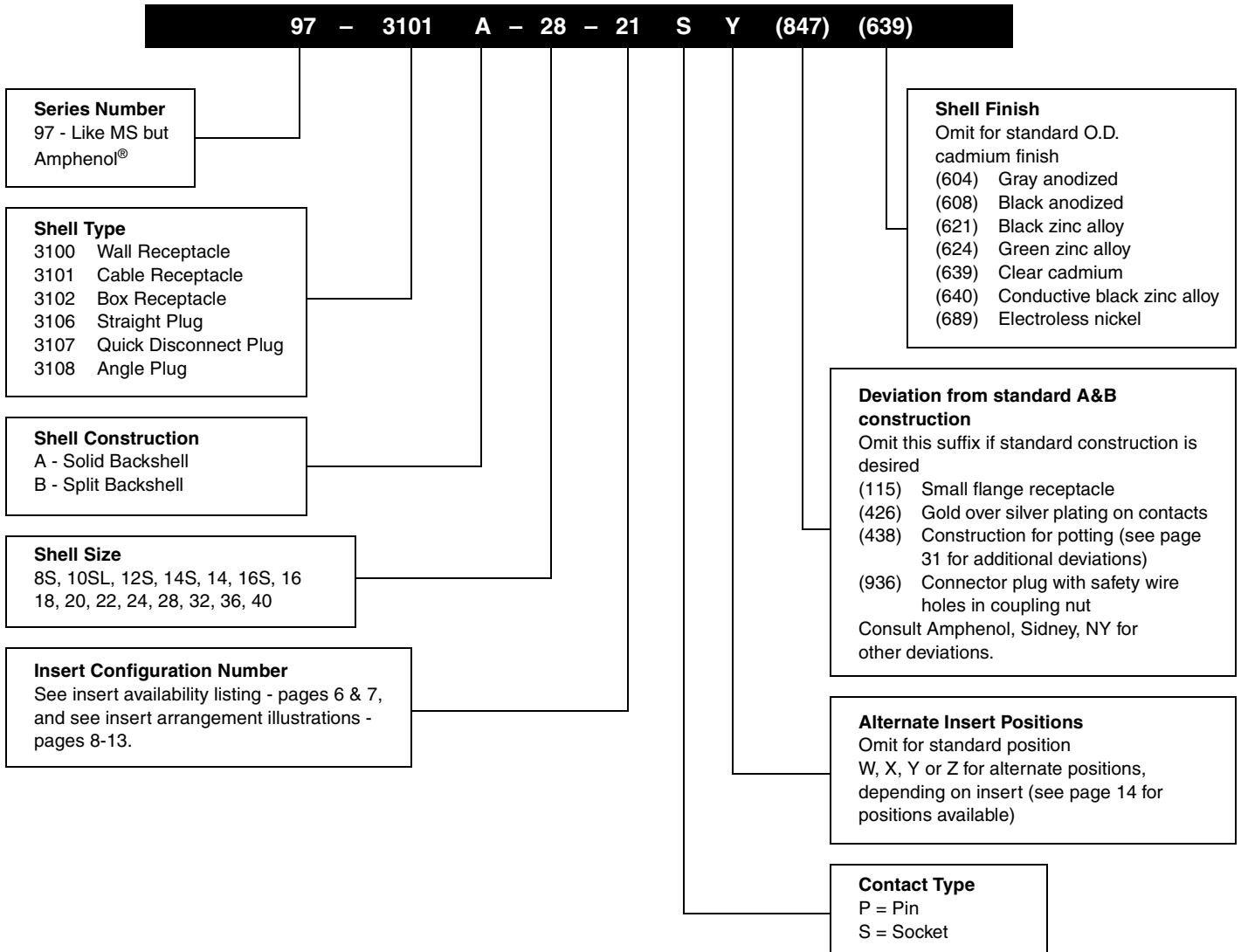

Note: Accessories for 97 Series Connectors should be ordered with matching connector plating. See accessory pages 35-41.

Amphenol® 97 Series Connectors with rear release crimp contacts



DESIGN CHARACTERISTICS

- Rugged metal shell
- Conductive finish
- Stamped & formed crimp contacts
- Closed entry socket contacts
- Plastic retention
- Utilizes standard 97 Series hardware
- Intermateable and intermountable with existing 97 Series and MIL-C-5015 connectors
- Underwriters Laboratories approved recognition File E115497
- Canadian Standards Association Certification File LR69183

CUSTOMER OPTIONS

- Positive self-centering of contacts; pins bent up to 20° will pick up
- Reduced user cost due to high speed termination
- Less equipment down-time due to fatigue failure at wire contact junction or handling damage
- Greater contact to contact insulation, lighter weight, higher reliability
- No costly re-design or rework necessary on existing equipment
- Complete flexibility through multi-source product availability
- 97E (environmental) crimp available - applications for jacketed cable only (290 suffix)

The Amphenol 97-410X connector design incorporates Poke Home® Rear Release contacts. The 97 Series Rear Release line is intermateable and intermountable with existing 97 Series and MIL-C-5015 type shell styles in both plugs and receptacles. The connectors utilize 97 Series bright cadmium plated shells and standard insert configurations.

The connector is designed to be used with stamped and formed type crimp contacts. Contact design (size 16 only) incorporates insulation crimp support for greater strength at wire termination end. Contacts are available on reel assemblies for use with the high speed Amphenol stripper crimper capable of crimping 1500 contacts per hour. Hand crimp tools and bulk packaged contacts are also available.

Standard hardware available for the 97 Series connector can be used with the 97 Series crimp contact rear release line. Accessories should be ordered with the appropriate deviation number to match the bright cadmium connector finish. See how to order, page 29, for 97 Series connectors with crimp contacts. See how to order, page 4, for 97E environmental crimp type connectors for jacketed cable applications.

97 series crimp type specifications, insert availability, alternate insert positioning

Specifications

Standard shell finish - clear chromate over cadmium plate (optional plating available, see how to order page 29).

Inserts - molded of a 94V-O Underwriters Laboratory rated material.

Contacts - copper alloy formed, silver plated (gold plating is also available, see how to order page 30).

Wire sizes - 12 AWG through 30 AWG.

All constructions perform satisfactorily from -55°C to $+125^{\circ}\text{C}$ (-67°F to $+257^{\circ}\text{F}$).

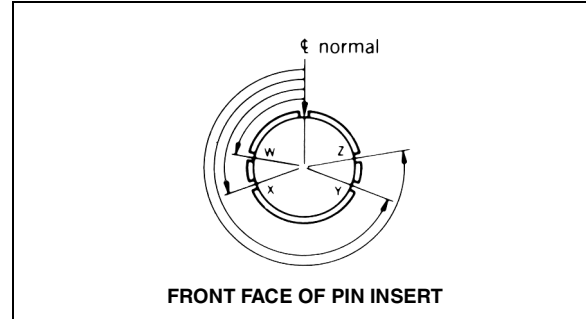

Insert Availability

| Insert Number | Total Contacts | Mechanical Spacing | | Service Rating | Contact Size | |
|---------------|----------------|--------------------|------|----------------|--------------|----|
| | | Inches | mm | | 12 | 16 |
| 10SL-3 | 3 | 1/16 | 1.57 | A | | 3 |
| 10SL-4 | 2 | 1/16 | 1.57 | A | | 2 |
| 12S-3 | 2 | 1/16 | 1.57 | A | | 2 |
| 14S-1 | 3 | 1/16 | 1.57 | A | | 3 |
| 14S-2 | 4 | | | INST. | | 4 |
| 14S-5 | 5 | | | INST. | | 5 |
| 14S-7 | 3 | 1/16 | 1.57 | A | | 3 |
| 16S-1 | 7 | 1/16 | 1.57 | A | | 7 |
| 16S-8 | 5 | 1/16 | 1.57 | A | | 5 |
| 18-1 | 10 | 1/16 | 1.57 | A | | 4 |
| | | | | INST. | | 6 |
| 18-4 | 4 | 1/8 | 3.18 | D | | 4 |
| 18-11 | 5 | 1/16 | 1.57 | A | 5 | |
| 18-12 | 6 | 1/16 | 1.57 | A | | 6 |
| 18-19 | 10 | 1/16 | 1.57 | A | | 10 |
| 18-20 | 5 | 1/16 | 1.57 | A | | 5 |
| 20-4 | 4 | 1/8 | 3.18 | D | 4 | |
| 20-7 | 8 | 1/8 | 3.18 | D | | 4 |
| | | 1/16 | 1.57 | A | | 4 |
| 20-27 | 14 | 1/16 | 1.57 | A | | 14 |
| 20-29 | 17 | 1/16 | 1.57 | A | | 17 |
| 22-14 | 19 | 1/16 | 1.57 | A | | 19 |
| 24-2 | 7 | 1/8 | 3.18 | D | 7 | |
| 28-9 | 12 | 1/8 | 3.18 | D | 6 | 6 |
| 28-11 | 22 | 1/16 | 1.57 | A | 4 | 18 |
| 28-12 | 26 | 1/16 | 1.57 | A | | 26 |
| 28-20 | 14 | 1/16 | 1.57 | A | 10 | 4 |
| 28-21 | 37 | 1/16 | 1.57 | A | | 37 |
| 32-414 | 52 | 1/16 | 1.57 | A | | 52 |
| 32-8 | 30 | 1/16 | 1.57 | A | 6 | 24 |
| 36-10 | 48 | 1/16 | 1.57 | A | | 48 |

Alternate Insert Positioning

| Insert Arrangement | Degrees | | | |
|--------------------|---------|------|------|------|
| | W | X | Y | Z |
| 12S-3 | 70 | 145 | 215 | 290 |
| 14S-2 | - | 120 | 240 | - |
| 14S-5 | - | 110 | - | - |
| 14S-7 | 90 | 180 | 270 | - |
| 16S-1 | 80 | - | - | 280 |
| 16S-8 | - | 170 | 265 | - |
| 18-1 | 70 | 145 | 215 | 290 |
| 18-4 | 35 | 110 | 250 | 325 |
| 18-11 | - | 170 | 265 | - |
| 18-12 | 80 | - | - | 280 |
| 18-19 | - | 120 | 240 | - |
| 18-20 | 90 | 180 | 270 | - |
| 20-4 | 45 | 110 | 250 | - |
| 20-7 | 80 | 110 | 250 | 280 |
| 20-27 | 35 | 110 | 250 | 325 |
| 20-29 | 80 | - | - | 280 |
| 22-14 | 80 | - | - | 280 |
| 24-2 | 80 | - | - | 280 |
| 28-9 | 80 | 110 | 250 | 280 |
| 28-11 | 80 | 110 | 250 | 280 |
| 28-12 | 90 | 180 | 270 | - |
| 28-20 | 80 | 110 | 250 | 280 |
| 28-21 | 80 | 110 | 250 | 280 |
| 32-8 | 80 | 125 | 235 | 280 |
| 32-414* | 80* | 110* | 250* | 280* |
| 36-10 | 80 | 125 | 235 | 280 |

* Rotates opposite above illustration.

97 series crimp type insert arrangements

Front view of pin insert or rear of socket insert illustrated.

2 Contacts

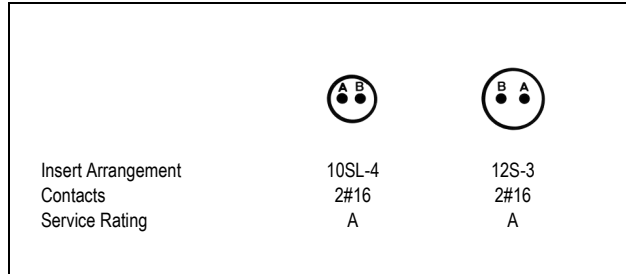

3 Contacts

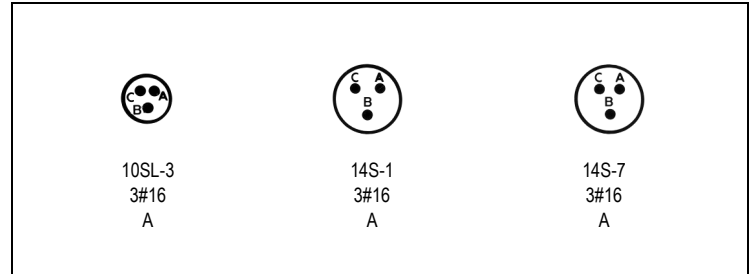

4 Contacts

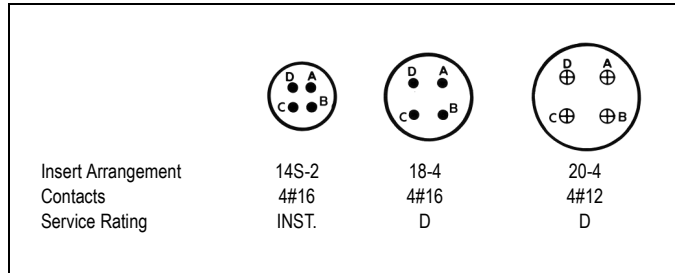

5 Contacts

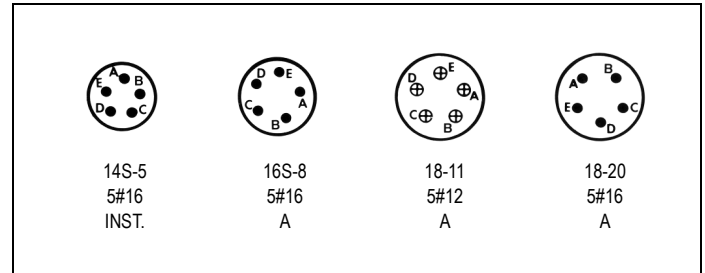

6 Contacts

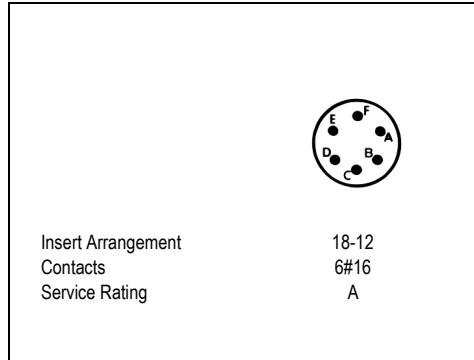

7 Contacts

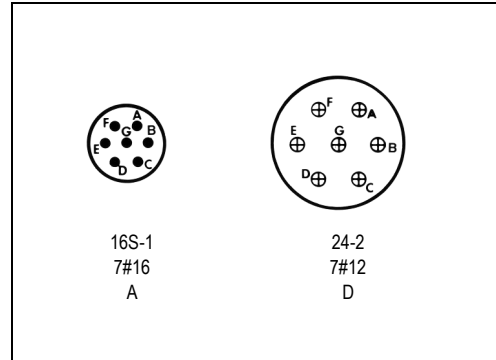

8 Contacts

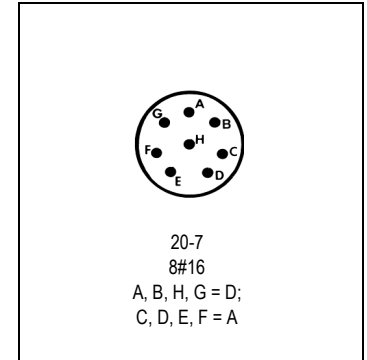

10 Contacts

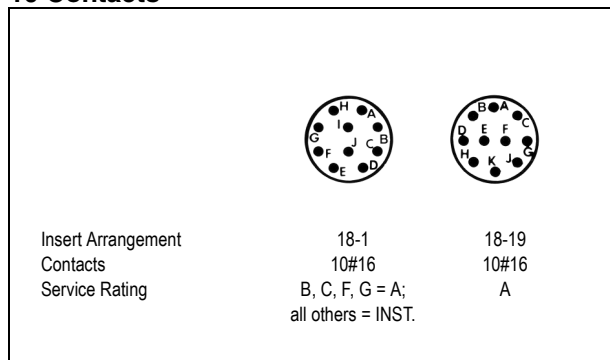

12 Contacts

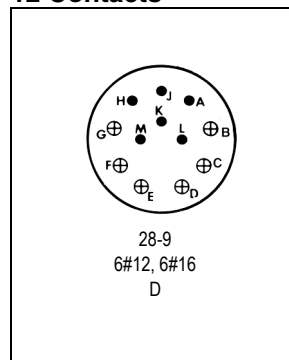

14 Contacts

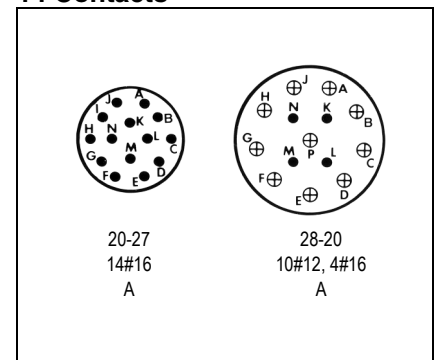

97 series crimp type insert arrangements, cont.

Front view of pin insert or rear of socket insert illustrated.

17 Contacts

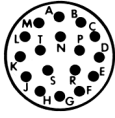

Insert Arrangement 20-29
 Contacts 17#16
 Service Rating A

19 Contacts

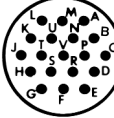

22-14
 19#16
 A

22 Contacts

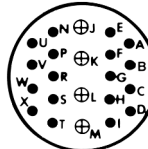

28-11
 4#12, 18#16
 A

26 Contacts

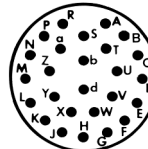

28-12
 26#16
 A

30 Contacts

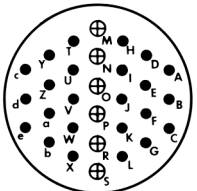

Insert Arrangement 32-8
 Contacts 6#12, 24#16
 Service Rating A

37 Contacts

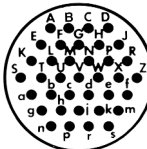

28-21
 37#16
 A

48 Contacts

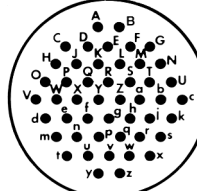

36-10
 48#16
 A

52 Contacts

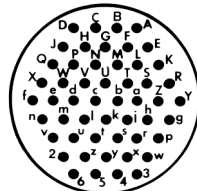

32-414
 52#16
 A

CONTACT LEGEND

| | |
|----|----|
| ● | ⊕ |
| 16 | 12 |

Current Ratings

| | | | | | | | | | |
|-----------|----|----|----|----|-----|----|----|-----|-----|
| Wire Size | 12 | 14 | 16 | 18 | 20 | 22 | 26 | 28 | 30 |
| Amperes | 23 | 17 | 13 | 10 | 7.5 | 5 | 2 | 1.5 | 1.0 |

NOTE: Design specifications subject to change.
 Consult Amphenol, Sidney, NY for the latest specifications
 and UL and CSA recognition.

Service Rating

| Service Rating | Recommended Operating Voltage* at Sea Level | |
|----------------|---|----------|
| | DC | AC (RMS) |
| INST. | 250 | 200 |
| A | 700 | 500 |
| D | 1250 | 900 |

* The values listed represent operating values which include a generous safety factor.

97 series crimp type receptacles

97-4100A wall mount receptacle

Solid shell construction is strong and conserves space. Includes integral polarizing key in front. Back shell is threaded for standard MS/AN fittings.

97-4101A cable receptacle

Solid shell construction is strong and conserves space. Includes integral polarizing key in front shell. Machined back shell is threaded for standard MS/AN fittings. Can be unscrewed for inspection or soldering

97-4102A box receptacle

Solid shell designed for open wiring. Mounts directly on chassis, equipment or panel. Includes internal polarized key in front shell.

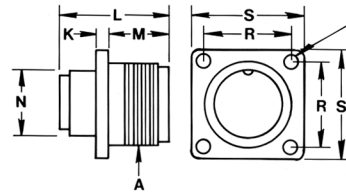
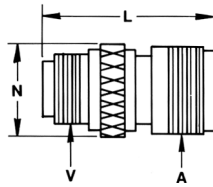
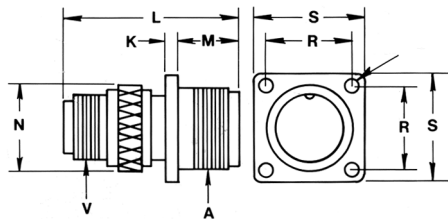

Mounting Holes
 .173 (4.394) DIA.
 FOR SIZES 32 AND 36
 .147 (3.734) DIA.
 FOR SIZES 24 and 28
 .120 (3.048) DIA.
 FOR ALL OTHER SIZES

Panel Opening

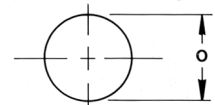

97-4100A and 97-4101A

| Connector Size | A Coupling Thread | K Ref. | | L Max. | | M Ref. | | N Ref. | | O Ref. | | R Ref. | | S Ref. | | V Fitting Threads |
|----------------|-------------------|--------|------|---------|-------|--------|-------|--------|-------|--------|-------|---------|-------|--------|-------|-------------------|
| | | Inch | mm | Inch | mm | Inch | mm | Inch | mm | Inch | mm | Inch | mm | Inch | mm | |
| 10SL | 5/8-24 | 5/64 | 1.98 | 1-9/32 | 32.53 | 9/16 | 14.27 | 3/4 | 19.05 | .812 | 20.62 | 23/32 | 18.24 | 1 | 25.40 | 5/8-24 |
| 12S | 3/4-20 | 5/64 | 1.98 | 1-15/32 | 37.29 | 9/16 | 14.27 | 25/32 | 19.84 | .812 | 20.62 | 13/16 | 20.62 | 1-3/32 | 27.76 | 5/8-24 |
| 14S | 7/8-20 | 5/64 | 1.98 | 1-15/32 | 37.39 | 9/16 | 14.27 | 7/8 | 22.23 | .938 | 23.83 | 29/32 | 23.01 | 1-3/16 | 30.15 | 3/4-20 |
| 16S | 1 -20 | 5/64 | 1.98 | 1-15/32 | 37.39 | 9/16 | 14.27 | 1 | 25.40 | 1.062 | 26.97 | 31/32 | 24.59 | 1-9/32 | 32.54 | 7/8-20 |
| 18 | 1-1/8-18 | 1/8 | 3.18 | 1-63/64 | 50.24 | 3/4 | 19.05 | 1-1/8 | 28.58 | 1.188 | 30.18 | 1-1/16 | 26.97 | 1-3/8 | 34.93 | 1 -20 |
| 20 | 1-1/4-18 | 1/8 | 3.18 | 1-57/64 | 47.85 | 3/4 | 19.05 | 1-1/4 | 31.75 | 1.312 | 33.32 | 1-5/32 | 29.36 | 1-1/2 | 38.10 | 1-3/16-18 |
| 22 | 1-3/8-18 | 1/8 | 3.18 | 1-63/64 | 50.24 | 3/4 | 19.05 | 1-3/8 | 34.93 | 1.438 | 36.53 | 1-1/4 | 31.75 | 1-5/8 | 39.67 | 1-3/16-18 |
| 24 | 1-1/2-18 | 1/8 | 3.18 | 2-14 | 57.15 | 13/16 | 20.62 | 1-1/2 | 38.10 | 1.562 | 36.67 | 1-3/8 | 34.43 | 1-3/4 | 44.45 | 1-7/16-18 |
| 28 | 1-3/4-18 | 1/8 | 3.18 | 2-1/4 | 57.15 | 13/16 | 20.62 | 1-3/4 | 44.45 | 1.812 | 46.02 | 1-9/16 | 39.67 | 2 | 50.80 | 1-7/16-18 |
| 32 | 2 -18 | 1/8 | 3.18 | 2-3/8 | 60.33 | 7/8 | 22.23 | 2-1/32 | 51.59 | 2.062 | 52.37 | 1-3/4 | 44.45 | 2-1/4 | 57.15 | 1-3/4-18 |
| 36 | 2-1/4-16 | 1/8 | 3.18 | 2-3/8 | 60.33 | 7/8 | 22.23 | 2-1/4 | 57.15 | 2.312 | 58.72 | 1-15/16 | 49.20 | 2-1/2 | 63.50 | 2 -18 |

97-4102A

| Connector Size | A Coupling Thread | K Ref. | | L Max. | | M Ref. | | N Ref. | | O Ref. | | R Ref. | | S Ref. | |
|----------------|-------------------|--------|------|---------|-------|--------|-------|---------|-------|--------|-------|---------|-------|--------|-------|
| | | Inch | mm | Inch | mm | Inch | mm | Inch | mm | Inch | mm | Inch | mm | Inch | mm |
| 10SL | 5/8-24 | 5/64 | 1.98 | 61.64 | 24.21 | 35/64 | 13.87 | 11/16 | 17.48 | .812 | 20.62 | 23/32 | 18.24 | 1 | 25.40 |
| 12S | 3/4-20 | 5/64 | 1.98 | 31/32 | 24.61 | 9/16 | 14.27 | 11/16 | 17.45 | .812 | 20.62 | 13/16 | 20.62 | 1-3/32 | 27.76 |
| 14S | 7/8-20 | 5/64 | 1.98 | 61/64 | 24.21 | 9/16 | 14.27 | 3/4 | 19.05 | .938 | 23.83 | 29/32 | 23.01 | 1-3/16 | 30.15 |
| 16S | 1 -20 | 5/64 | 1.98 | 61/64 | 24.21 | 9/16 | 14.27 | 7/8 | 22.23 | 1.062 | 26.97 | 31/32 | 24.59 | 1-9/32 | 32.54 |
| 18 | 1-1/8-18 | 1/8 | 3.18 | 1-3/8 | 34.92 | 3/4 | 19.05 | 1 | 25.40 | 1.188 | 30.18 | 1-1/16 | 26.97 | 1-3/8 | 34.93 |
| 20 | 1-1/4-18 | 1/8 | 3.18 | 1-3/8 | 34.92 | 3/4 | 19.05 | 1-1/8 | 28.58 | 1.312 | 33.32 | 1-5/32 | 29.36 | 1-1/2 | 38.10 |
| 22 | 1-3/8-18 | 1/8 | 3.18 | 1-3/8 | 34.92 | 3/4 | 19.05 | 1-1/4 | 31.75 | 1.438 | 36.53 | 1-1/4 | 31.75 | 1-5/8 | 41.28 |
| 24 | 1-1/2-18 | 1/8 | 3.18 | 1-3/8 | 34.92 | 13/16 | 20.62 | 1-3/8 | 34.93 | 1.562 | 39.67 | 1-3/8 | 34.93 | 1-3/4 | 44.45 |
| 28 | 1-3/4-18 | 1/8 | 3.18 | 1-3/8 | 34.92 | 13/16 | 20.62 | 1-5/8 | 41.28 | 1.812 | 46.02 | 1-9/16 | 39.67 | 2 | 50.80 |
| 32 | 2 -18 | 1/8 | 3.18 | 1-15/32 | 37.31 | 7/8 | 22.23 | 1-29/32 | 48.41 | 2.062 | 52.37 | 1-3/4 | 44.45 | 2-1/4 | 57.15 |
| 36 | 2-1/4-18 | 1/8 | 3.18 | 1-15/32 | 37.31 | 7/8 | 22.23 | 2-1/8 | 53.98 | 2.312 | 58.72 | 1-15/16 | 49.20 | 2-1/2 | 63.50 |

97 series crimp type plugs with solid shells

97-4106A

| Connector Size | L Max. | | N Ref. | | Q Max. | | V Fitting Threads |
|----------------|---------|-------|--------|-------|---------|-------|-------------------|
| | Inch | mm | Inch | mm | Inch | mm | |
| 10SL | 1-3/8 | 34.93 | 3/4 | 19.05 | 7/8 | 22.23 | 5/8-24 |
| 12S | 1-7/16 | 36.50 | 25/32 | 19.84 | 1 | 25.40 | 5/8-24 |
| 14S | 1-15/32 | 37.13 | 7/8 | 22.23 | 1-1/8 | 28.58 | 3/4-20 |
| 16S | 1-15/32 | 37.13 | 1 | 25.40 | 1-1/4 | 31.75 | 7/8-20 |
| 18 | 1-31/32 | 49.88 | 1-1/8 | 28.57 | 1-11/32 | 34.11 | 1 -20 |
| 20 | 1-7/8 | 47.50 | 1-1/4 | 31.75 | 1-15/32 | 37.29 | 1-3/16-18 |
| 22 | 1-31/32 | 49.88 | 1-3/8 | 34.93 | 1-19/32 | 40.46 | 1-3/16-18 |
| 24 | 2-1/4 | 57.15 | 1-1/2 | 38.10 | 1-23/32 | 43.64 | 1-7/16-18 |
| 28 | 2-1/4 | 57.15 | 1-3/4 | 44.45 | 1-31/32 | 49.99 | 1-7/16-18 |
| 32* | 2-3/8 | 60.33 | 2-1/32 | 51.59 | 2-7/32 | 56.34 | 1-3/4-18 |
| 36* | 2-3/8 | 60.33 | 2-1/4 | 57.15 | 2-15/32 | 62.69 | 2 -18 |

97-4106A straight plug

Sturdy, simple to assemble. Coupling ring machined from solid aluminum bar stock for high tensile strength. Mates with all types of MS receptacles. Front shell includes polarizing keyway. Back shell is threaded for standard MS/AN fittings.

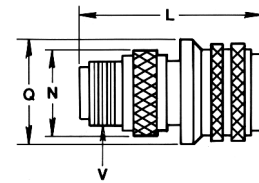

97-4107A

| Connector Size | L Max. | | N Ref. | | Q Max. | | V Fitting Threads |
|----------------|---------|-------|--------|-------|---------|-------|-------------------|
| | Inch | mm | Inch | mm | Inch | mm | |
| 10SL | 1-3/8 | 34.92 | 3/4 | 19.05 | 7/8 | 22.23 | 5/8-24 |
| 12S | 1-7/16 | 36.50 | 25/32 | 19.84 | 1 | 25.40 | 5/8-24 |
| 14S | 1-15/32 | 37.13 | 7/8 | 22.23 | 1-1/8 | 38.58 | 3/4-20 |
| 16S | 1-15/32 | 37.13 | 1 | 25.40 | 1-1/4 | 31.75 | 7/8-20 |
| 16 | 1-7/8 | 47.47 | 1 | 25.40 | 1-1/4 | 31.75 | 7/8-20 |
| 18 | 1-31/32 | 49.88 | 1-1/8 | 28.58 | 1-11/32 | 34.11 | 1 -20 |
| 20 | 1-7/8 | 47.50 | 1-1/4 | 31.75 | 1-15/32 | 37.29 | 1-3/16-18 |
| 22 | 1-31/32 | 49.88 | 1-3/8 | 34.93 | 1-19/32 | 40.46 | 1-3/16-18 |
| 24 | 2-1/4 | 57.15 | 1-1/2 | 38.10 | 1-23/32 | 43.64 | 1-7/16-18 |
| 28 | 2-1/4 | 57.15 | 1-3/4 | 44.45 | 1-31/32 | 49.99 | 1-7/16-18 |
| 32* | 2-3/8 | 60.33 | 2-1/32 | 51.59 | 2-7/32 | 56.34 | 1-3/4-18 |
| 36* | 2-3/8 | 60.33 | 2-1/4 | 57.15 | 2-15/32 | 62.69 | 2 -18 |

97-4107A quick-disconnect plug

For fast connect/disconnect applications. Front shell has polarizing keyway. Back shell is threaded for standard MS/AN fittings.

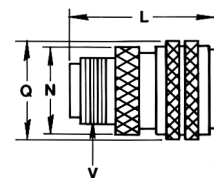

97-4108A

| Connector Size | L Ref. | | Q Max. | | U Ref. | | V Fitting Threads | Y Ref. | |
|----------------|---------|-------|---------|-------|--------|-------|-------------------|--------|-------|
| | Inch | mm | Inch | mm | Inch | mm | | Inch | mm |
| 10SL | 1-5/16 | 33.32 | 7/8 | 22.23 | 1 | 25.40 | 5/8-24 | 1-1/16 | 26.97 |
| 12S | 1-3/8 | 34.93 | 1 | 25.40 | 1 | 25.40 | 5/8-24 | 1-1/16 | 26.97 |
| 14S | 1-3/8 | 34.93 | 1-1/8 | 28.58 | 1 | 25.40 | 3/4-20 | 1-1/16 | 26.97 |
| 16S | 1-1/2 | 38.10 | 1-1/4 | 31.75 | 1-1/8 | 28.58 | 7/8-20 | 1-5/16 | 33.32 |
| 18 | 1-15/16 | 49.20 | 1-11/32 | 34.11 | 1-1/8 | 28.58 | 1 -20 | 1-5/16 | 33.32 |
| 20 | 2-1/16 | 52.37 | 1-15/32 | 37.29 | 1-5/16 | 33.32 | 1-3/16-18 | 1-5/8 | 42.28 |
| 22 | 2-1/16 | 52.37 | 1-19/32 | 40.46 | 1-5/16 | 33.32 | 1-3/16-18 | 1-5/8 | 42.28 |
| 24 | 2-15/32 | 62.69 | 1-23/32 | 43.64 | 1-1/2 | 38.10 | 1-7/16-18 | 2 | 50.80 |
| 28 | 2-15/32 | 62.69 | 1-31/32 | 49.99 | 1-1/2 | 38.10 | 1-7/16-18 | 2 | 50.80 |

97-4108A angle plug

For use where space in front of panel or wall is at a premium. Swivel ring and plate combination allow cable take off at any angle relative to front shell polarizing key. Back shell is threaded for standard MS/AN fittings.

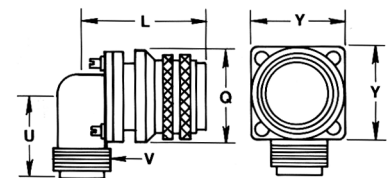

* Available for 97-4106A only.

97 series crimp type plugs with split shells

97-4106B

| Connector Size | L Max. | | Q Max. | | V Fitting Threads | Y Ref. | |
|----------------|---------|-------|---------|-------|-------------------|---------|-------|
| | Inch | mm | Inch | mm | | Inch | mm |
| 14S | 1-11/16 | 42.85 | 1-1/8 | 28.58 | 3/4-20 | 1-5/32 | 29.36 |
| 16S | 1-11/16 | 42.85 | 1-1/4 | 31.75 | 7/8-20 | 1-1/4 | 31.75 |
| 18 | 2-1/16 | 52.37 | 1-11/32 | 34.11 | 1 -20 | 1-41/64 | 41.66 |
| 20 | 2-1/8 | 53.98 | 1-15/32 | 37.29 | 1-3/16-18 | 1-13/16 | 46.02 |
| 22 | 2-1/8 | 53.98 | 1-19/32 | 40.46 | 1-3/16-18 | 1-15/16 | 49.20 |
| 24 | 2-9/32 | 57.94 | 1-23/32 | 43.64 | 1-7/16-18 | 2-1/16 | 52.37 |
| 28 | 2-9/32 | 57.94 | 1-31/32 | 49.99 | 1-3/4-18 | 2-5/16 | 58.72 |
| 32 | 2-5/16 | 58.72 | 2-7/32 | 56.34 | 1-3/4-18 | 2-19/32 | 65.86 |
| 36 | 2-11/32 | 59.51 | 2-15/32 | 62.69 | 2 -18 | 2-27/32 | 72.21 |

97-4106B straight plug

Used for unusual conduit applications where soldering and inspection is the prime requirement. Back shell is threaded for all standard MS/AN fittings.

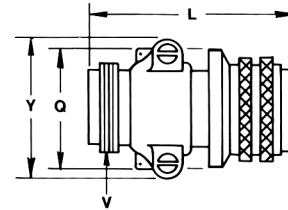

97-4107B

| Connector Size | L Max. | | Q Max. | | V Fitting Threads | Y Ref. | |
|----------------|---------|-------|---------|-------|-------------------|---------|-------|
| | Inch | mm | Inch | mm | | Inch | mm |
| 14S | 1-11/16 | 42.85 | 1-1/8 | 28.58 | 3/4-20 | 1-5/32 | 29.36 |
| 16S | 1-11/16 | 42.85 | 1-1/4 | 31.75 | 7/8-20 | 1-1/4 | 31.75 |
| 18 | 2-1/16 | 52.37 | 1-11/32 | 34.11 | 1 -20 | 1-41/64 | 41.66 |
| 20 | 2-1/8 | 53.99 | 1-15/32 | 37.29 | 1-3/16-18 | 1-13/16 | 46.02 |
| 22 | 2-1/8 | 53.99 | 1-19/32 | 40.46 | 1-3/16-18 | 1-15/16 | 49.20 |
| 24 | 2-9/32 | 57.94 | 1-23/32 | 43.64 | 1-7/16-18 | 2-1/16 | 52.37 |
| 28 | 2-9/32 | 57.94 | 1-31/32 | 49.99 | 1-7/16-18 | 2-5/16 | 58.72 |

97-4107B quick-disconnect plug

For fast connect/disconnect applications. Front shell has polarizing keyway. Mates with all types of MS receptacles. Back shell is threaded for standard MS/AN fittings.

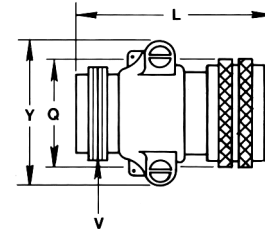

97-4108B

| Connector Size | L Ref. | | Q Max. | | U Ref. | | V Fitting Threads | X Ref. | |
|----------------|---------|-------|---------|-------|---------|-------|-------------------|---------|-------|
| | Inch | mm | Inch | mm | Inch | mm | | Inch | mm |
| 10SL | 1-1/2 | 38.10 | 7/8 | 22.23 | 1 | 25.40 | 5/8-24 | | |
| 12S | 1-9/16 | 39.67 | 1 | 25.40 | 1 | 25.40 | 5/8-24 | 1/2 | 12.70 |
| 14S | 1-23/32 | 43.64 | 1-1/8 | 28.58 | 1-1/16 | 26.97 | 3/4-20 | 21/32 | 16.66 |
| 16S | 1-3/4 | 44.45 | 1-1/4 | 31.75 | 1-1/8 | 28.58 | 7/8-20 | 1-1/2 | 38.10 |
| 18 | 2-5/32 | 54.75 | 1-11/32 | 34.11 | 1-3/16 | 30.15 | 1 -20 | 1-41/64 | 41.66 |
| 20 | 2-3/8 | 60.33 | 1-15/32 | 37.29 | 1-5/16 | 33.32 | 1-3/16-18 | 1-13/16 | 46.02 |
| 22 | 2-13/32 | 61.11 | 1-19/32 | 40.46 | 1-5/16 | 33.32 | 1-3/16-18 | 1-15/16 | 49.20 |
| 24 | 2-5/8 | 66.68 | 1-23/32 | 43.64 | 1-7/16 | 36.50 | 1-7/16-18 | 2-1/16 | 52.37 |
| 28 | 2-5/8 | 66.68 | 1-31/32 | 49.99 | 1-7/16 | 36.50 | 1-7/16-18 | 2-5/16 | 58.72 |
| 32 | 2-13/16 | 71.42 | 2-7/32 | 56.34 | 1-3/4 | 44.45 | 1-3/4-18 | 2-19/32 | 65.86 |
| 36 | 2-27/32 | 72.21 | 2-15/32 | 62.69 | 1-15/16 | 49.20 | 2 -18 | 2-27/32 | 72.21 |

97-4108B angle plug

Lightweight, roomy cavity, split longitudinally for convenient inspection. Front shell is keyed to allow the 90° angle housing to be rotated and locked at any 45° increment.

Sizes 10SL thru 14S

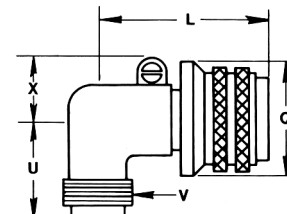

Sizes 16S thru 36

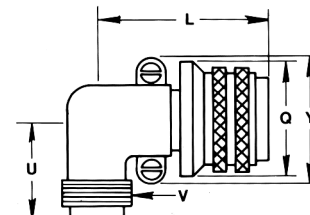

97 series crimp type

how to order

Example of part number for non-environmental crimp type connectors is given below.
 (For environmental crimp type connectors, see how to order on page 4).

97 - 4101 A - 28 - 21 S Y (621)

Series Number
 97 - designates AMPHENOL 97 Series

Shell Type
 4100 Wall Receptacle
 4101 Cable Receptacle
 4102 Box Receptacle
 4106 Straight Plug
 4107 Quick Disconnect Plug
 4108 Angle Plug
 Note: "4" in part number designates crimp contact rear release connector

Shell Construction
 A - Solid Backshell
 B - Split Backshell

Shell Size
 10SL, 12S, 14S, 16S, 18, 20, 22, 24, 28, 32, 36

Insert Configuration Number
 See insert availability listing - page 23, and see insert arrangement illustrations - pages 24 and 25.

Shell Finish
 Omit for standard (639) bright cadmium finish
 (604) Gray anodized
 (608) Black anodized
 (621) Black zinc alloy
 (624) Green zinc alloy
 (640) Conductive black zinc alloy
 (662) Olive drab cadmium
 (689) Electroless nickel

Alternate Insert Positions
 Omit for standard position
 W, X, Y or Z for alternate positions, depending on insert (see page 23 for positions available)

Contact Type*
 P = Pin
 S = Socket

* Contacts are not supplied with connectors, and must be ordered separately. See following pages for contact information.

Note:
 Accessories for 97 Series Connectors should be ordered with matching connector plating. See accessory pages 35-41.

97 series crimp type contact information

Crimp contacts can be ordered for 97 Series connectors in reel assemblies or in bulk packaging. Order by part numbers given below:

Reel Assembly - For use with semi-automatic crimping equipment; order number of reels required.

Reel Assemblies Available

| Part Number | Size | For Connector Sizes |
|-----------------|------|--------------------------|
| 9738-1216P-X250 | 12 | 18 thru 36 |
| 9738-1216S-X250 | 12 | 18 thru 36 |
| 9745-1418P-X400 | 16 | 10SL thru 36 |
| 9745-1418S-X400 | 16 | 18 thru 36 |
| 9755-1418S-X400 | 16 | 10SL thru 16S only |
| 9745-1622P-X400 | 16 | 10SL thru 36 |
| 9755-1622S-X400 | 16 | 10SL, 12S, 14S, 16S only |
| 9745-1622S-X400 | 16 | 18 thru 36 |
| 9745-2026P-X400 | 16 | 10SL thru 36 |
| 9755-2026S-X400 | 16 | 10SL, 12S, 14S, 16S only |
| 9745-2026S-X400 | 16 | 18 thru 36 |
| 9745-2630P-X400 | 16 | 10SL thru 36 |
| 9755-2630S-X400 | 16 | 10SL, 12S, 14S, 16S only |
| 9745-2630S-X400 | 16 | 18 thru 36 |

Example of part number:

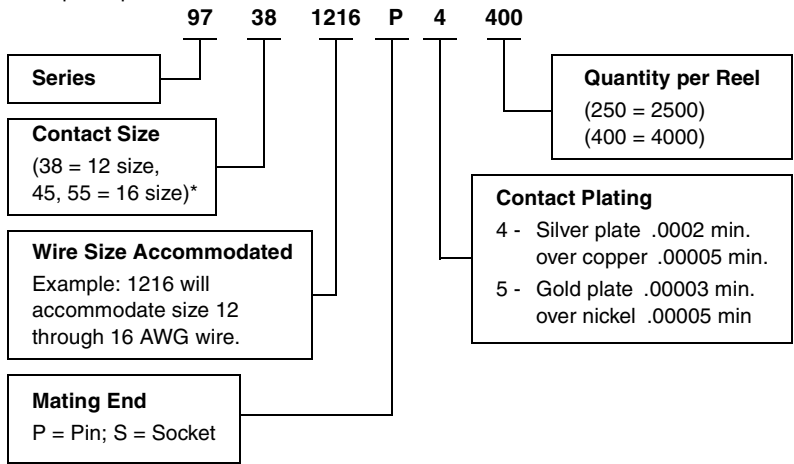

Bulk Packaged Contacts Available

| Part Number | Size | For Connector Sizes |
|-------------------|------|--------------------------|
| 9738-1216P-X(920) | 12 | 18 thru 36 |
| 9738-1216S-X(920) | 12 | 18 thru 36 |
| 9745-1418P-X(920) | 16 | 10SL thru 36 |
| 9745-1418S-X(920) | 16 | 18 thru 36 |
| 9755-1418S-X(920) | 16 | 10SL thru 16S only |
| 9745-1622P-X(920) | 16 | 10SL thru 36 |
| 9755-1622S-X(920) | 16 | 10SL, 12S, 14S, 16S only |
| 9745-1622S-X(920) | 16 | 18 thru 36 |
| 9745-2026P-X(920) | 16 | 10SL thru 36 |
| 9755-2026S-X(920) | 16 | 10SL, 12S, 14S, 16S only |
| 9745-2026S-X(920) | 16 | 18 thru 36 |
| 9745-2630P-X(920) | 16 | 10SL thru 36 |
| 9755-2630S-X(920) | 16 | 10SL, 12S, 14S, 16S only |
| 9745-2630S-X(920) | 16 | 18 thru 36 |

Example of part number:

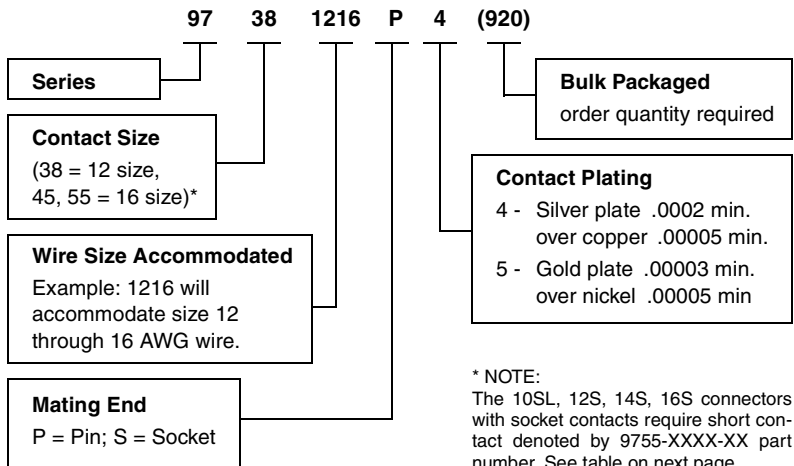

* NOTE:
The 10SL, 12S, 14S, 16S connectors with socket contacts require short contact denoted by 9755-XXXX-XX part number. See table on next page.

97 Series Contact Code Table†

| Wire Range** | Contact Code | Pin | Contact Code | Socket | Contact Code | Socket |
|--------------|--------------|--------------------|--------------|--------------------|--------------|--------------------|
| 1622 | A | 97-45-1622P-X(XXX) | B | 97-55-1622S-X(XXX) | C | 97-45-1622S-X(XXX) |
| 1418 | D | 97-45-1418P-X(XXX) | E | 97-55-1418S-X(XXX) | F | 97-45-1418S-X(XXX) |
| 2026 | G | 97-45-2026P-X(XXX) | H | 97-55-2026S-X(XXX) | I | 97-45-2026S-X(XXX) |
| 2630 | J | 97-45-2630P-X(XXX) | K | 97-55-2630S-X(XXX) | L | 97-45-2030S-X(XXX) |
| 1216 | M | 97-38-1216P-X(XXX) | | | O | 97-38-1216S-X(XXX) |

Codes in bold letters are most common

† See order information for bulk and reel contact deviation numbers.

** Wire range is size of wires contact will accommodate. For example: wire range 1622 will accommodate size 16 through 22.

97 series crimp type contact information and tools

Insert / Contact Where Used Table

| Insert Arrangement | Contact Quantity | Contact Size | Use Contacts with Code* | | Insert Arrangement | Contact Quantity | Contact Size | Use Contacts with Code* | |
|--------------------|------------------|--------------|-------------------------|--------------------|--------------------|------------------|--------------|-------------------------|--------------------|
| | | | Pin | Socket | | | | Pin | Socket |
| 10SL-3 | 3 | 16 | A , D, G, J | B , E, H, K | 18-20 | 5 | 16 | A , D, G, J | C , F, I, L |
| 10SL-4 | 2 | 16 | A , D, G, J | B , E, H, K | 20-4 | 4 | 12 | M | O |
| 12S-3 | 2 | 16 | A , D, G, J | B , E, H, K | 20-7 | 8 | 16 | A , D, G, J | C , F, I, L |
| 14S-1 | 3 | 16 | A , D, G, J | B , E, H, K | 20-27 | 14 | 16 | A , D, G, J | C , F, I, L |
| 14S-2 | 4 | 16 | A , D, G, J | B , E, H, K | 22-14 | 19 | 16 | A , D, G, J | C , F, I, L |
| 14S-5 | 5 | 16 | A , D, G, J | B , E, H, K | 24-2 | 7 | 12 | M | O |
| 14S-7 | 3 | 16 | A , D, G, J | B , E, H, K | 28-11 | 4 | 12 | M | O |
| 16S-1 | 7 | 16 | A , D, G, J | B , E, H, K | | 18 | 16 | A , D, G, J | C , F, I, L |
| 16S-8 | 5 | 16 | A , D, G, J | B , E, H, K | 28-12 | 26 | 16 | A , D, G, J | C , F, I, L |
| 18-1 | 10 | 16 | A , D, G, J | C , F, I, L | 28-20 | 10 | 12 | M | O |
| 18-4 | 4 | 16 | A , D, G, J | C , F, I, L | | 4 | 16 | A , D, G, J | C , F, I, L |
| 18-11 | 5 | 12 | M | O | 28-21 | 37 | 16 | A , D, G, J | C , F, I, L |
| 18-12 | 6 | 16 | A , D, G, J | C , F, I, L | 32-414 | 52 | 16 | A , D, G, J | C , F, I, L |
| 18-19 | 10 | 16 | A , D, G, J | C , F, I, L | 36-10 | 48 | 16 | A , D, G, J | C , F, I, L |

Codes in bold letters are most common

Contact Termination Tools

Insertion / Extraction Tools

| Part Number: | Contact Size | |
|--------------|--------------|--------------|
| | 16 | 12 |
| | M81969/14-03 | M81969/14-04 |

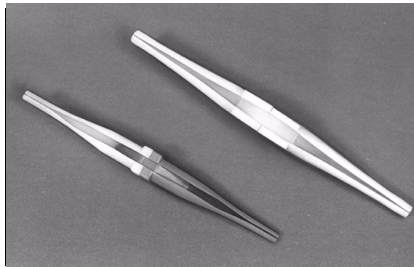

Crimping Tools (Full Cycle Type)

| Crimping Tool Part Number | Contact Part Number |
|---------------------------|--|
| 357-578 | 9738-1216X-X thru 9755-1622X-X |
| 357-579 | 9745-2026X-X 9745-2630X-X 9755-2026X-X 9755-2630X-X |



Strip-Crimp Machines

For large production quantities consult Amphenol, Sidney, NY for information on semi-automatic crimping equipment.

Wire Preparation

Strip wire to length shown in chart below. Do not cut or nick wire strands. Twist wire strands back to their original lay.

| Contact Size | Contact Part Number | Insulation O.D. | Stripping Length "A" |
|--------------|---------------------|-----------------|----------------------|
| 12 | 9738-1216X-X | .097 / .160 | .200 - .240 |
| 16 | 97XX-1418X-XX | .079 / .100 | .170 - .190 |
| 16 | 97XX-1622X-X | .079 / .100 | .140 - .160 |
| 16 | 97XX-2026X-X | .039 / .090 | .140 - .160 |
| 16 | 97XX-2630X-X | .030 / .054 | .140 - .160 |

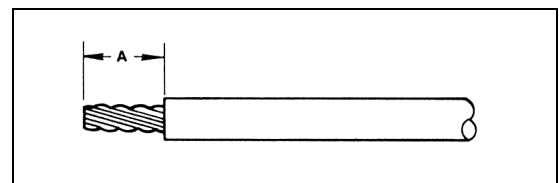

Note: XX = 45 or 55 (38 = 12 size; 45, 55 = 16 size)

For further information on contact insertion/removal/crimping for 97 Series Connectors, ask for L-1268 assembly instructions.

97 series

special purpose connectors

Potting (438 Construction)

Potting constructions actually exceed the Type “E” requirements of military specifications for moisture-proof connectors. These constructions replace the back shell completely with a lightweight threaded retainer ring permanently staked to the shell.

To seal the back of the connector, potting compound is injected into an expendable polyethylene potting form and allowed to cure or set. When the form is removed, the resilient hemispherical shaped insulation extends well into the connector. It forms a chemical bond to the inner and outer walls of the plug, to the back of the insert, around the soldered connections and well out along the leads.

Not only is the back shell eliminated, but also the cable clamp. The solder joints are completely and individually protected by the resilient mass which surrounds them and resists transmittal of vibration to the soldered connections. The completed assembly is not only moisture-proof, but also pressurized and resistant to salt water, aircraft lubricating oil and jet fuels.



Expendable Potting Forms

For companies not using their own potting molds, expendable polyethylene forms can be provided. These expendable forms need no treatment before use. Though designed to be discarded, they can be left on assemblies after potting. Nylon potting forms to be left permanently on the assembly are also available. These forms are supplied with construction (824) and (871).

How to Order

To order connectors in constructions for potting, use the standard MS nomenclature (MS3100A, MS3101A, and MS3106A constructions are available), but substitute “97” for “MS”, drop the “A” suffix for type of back shell, and add the application deviation (XXX) as shown on the chart. Example: 97-3106-28-16S (438).

| Deviation | Explanation | Shell Styles | |
|-----------|--|--------------|--------------|
| | | 3100 3101 | 3106 3107 |
| 438 | Modified “MS”, for potting where back shell is replaced by threaded retainer ring. A type “W” washer is included under 3106 coupling ring. (Boot is not included). | 3100 3101 | 3106 3107 |
| 541 | Consists of (438) construction with 9755-255-XX expendable poly potting form, and type “W” washer. Connectors are marked “97-310X-XX-XX(541).” | 3100 3101 | 3106 3107 |
| 824 | Consists of (438) construction plus nylon potting form and type “W” washer; bagged, marked MS25183. | 3106 | |
| 826 | Consists of (517) construction plus nylon potting form and type “W” washer; marked MS25183A. | 3106 | |
| 871 | Consists of (438) construction with 9755-271-XX nylon potting form, and type “W” washer; bagged. Connectors are marked “97-310X-XX-XX(871).” | 3100 3101 | 3106 3107 |

97 series special purpose connectors

Box Type Plugs (97-5105 construction)

Mounts directly on box or housing. For direct connection of two pieces of equipment without interconnecting wires. Available in all sizes; male or female inserts. To order, complete part number (97-5105) by adding proper insert number.

Example: 97-5105-28-20S. To prevent connector from rotating: Order deviation 205 (single stake, with swivel ring pinned) or 206 (double staking, with both swivel plate and swivel ring pinned).

Example: 97-5105-28-20S (205) or 97-5105-28-20S (206).

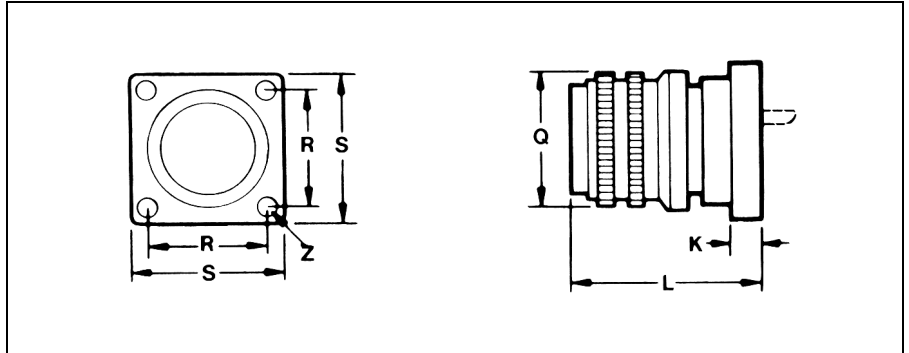

| Connector Size | K | | L | | Q | | R | | S | | Z Mounting Threads |
|----------------|------|------|---------|-------|---------|-------|--------|-------|--------|-------|--------------------|
| | Inch | mm | Inch | mm | Inch | mm | Inch | mm | Inch | mm | |
| 8S | 1/8 | 3.18 | 7/8 | 22.23 | 3/4 | 19.05 | 9/16 | 14.27 | 25/32 | 19.84 | 4-36 |
| 10S | 1/8 | 3.18 | 7/8 | 22.23 | 7/8 | 22.23 | 9/16 | 14.27 | 25/32 | 19.84 | 4-36 |
| 12S | 5/32 | 3.96 | 31/32 | 24.59 | 1 | 25.40 | 13/16 | 20.62 | 1-1/16 | 26.97 | 4-36 |
| 12 | 5/32 | 3.96 | 1-3/8 | 34.93 | 1 | 25.40 | 13/16 | 20.62 | 1-1/16 | 26.97 | 4-36 |
| 14S | 5/32 | 3.96 | 31/32 | 24.59 | 1-1/8 | 28.56 | 13/16 | 20.62 | 1-1/16 | 26.97 | 4-36 |
| 14 | 5/32 | 3.96 | 1-3/8 | 34.93 | 1-1/8 | 28.56 | 13/16 | 20.62 | 1-1/16 | 26.97 | 4-36 |
| 16S | 5/32 | 3.96 | 31/32 | 24.59 | 1-1/4 | 31.75 | 1 | 25.40 | 1-5/16 | 33.32 | 6-32 |
| 16 | 5/32 | 3.96 | 1-13/32 | 35.71 | 1-1/4 | 31.75 | 1 | 25.40 | 1-5/16 | 33.32 | 6-32 |
| 18 | 5/32 | 3.96 | 1-13/32 | 35.71 | 1-11/32 | 34.11 | 1 | 25.40 | 1-5/16 | 33.32 | 6-32 |
| 20 | 3/16 | 4.75 | 1-13/32 | 35.71 | 1-15/32 | 37.29 | 1-1/4 | 31.75 | 1-5/8 | 41.28 | 10-24 |
| 22 | 3/16 | 4.75 | 1-13/32 | 35.71 | 1-19/32 | 40.46 | 1-1/4 | 31.75 | 1-5/8 | 41.28 | 10-24 |
| 24 | 3/16 | 4.75 | 1-13/32 | 35.71 | 1-23/32 | 43.64 | 1-9/16 | 39.67 | 2 | 50.80 | 10-24 |
| 28 | 3/16 | 4.75 | 1-13/32 | 35.71 | 1-31/32 | 49.99 | 1-9/16 | 39.67 | 2 | 50.80 | 10-24 |

Small Flange Receptacle

Small flange, (115) construction, receptacles are available in sizes 12S and 14S with pin or socket inserts and in size 10SL with pin contacts only.

To order, complete part number (97-3102) by adding proper insert and construction numbers; 97-3102A12S-4S (115).

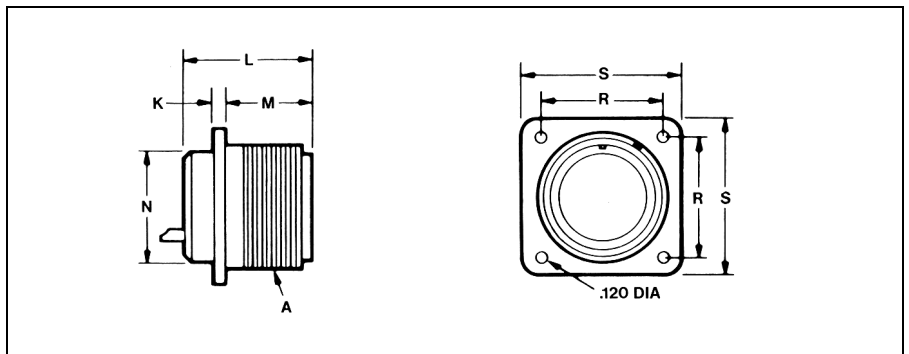

| Connector Size | A Coupling Threads | K Ref. | | L Max. | | M Ref. | | N Ref. | | R Ref. | | S Ref. | |
|----------------|--------------------|--------|------|--------|-------|--------|-------|--------|-------|--------|-------|--------|-------|
| | | Inch | mm | Inch | mm | Inch | mm | Inch | mm | Inch | mm | Inch | mm |
| 10SL | 5/8-24 | 5/64 | 1.98 | 61/64 | 24.21 | 9/16 | 14.27 | 5/8 | 15.88 | .625 | 15.88 | 13/16 | 20.62 |
| 12S | 3/4-20 | 3/32 | 2.36 | 7/8 | 21.41 | 9/16 | 14.27 | 5/8 | 15.88 | .664 | 16.87 | 7/8 | 22.23 |
| 14S | 7/8-20 | 3/32 | 2.36 | 7/8 | 21.41 | 9/16 | 14.27 | 23/32 | 18.24 | .730 | 18.54 | 15/16 | 23.80 |

97 series special purpose connectors

ECG Connectors

For ECG monitoring cable and equipment. Meets requirements of ECG connector standard draft by A.A.M.I. (Association for the Advancement of Medical Instrumentation). Standard number in A.A.M.I. ECGC-D 10/75.

Note:

This connector is to be used **only** for apparatus as described in the A.A.M.I. Standard "A.A.M.I. ECG Connector Standard." Other uses may result in a possible hazardous connection.

7-8905

97-3102A14S-6S (639)
with insert rotated 30° off normal position between contacts "A" and "F".

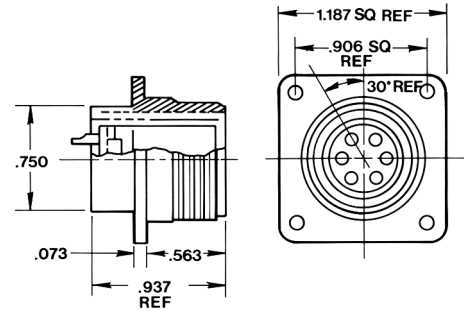

7-8906

97-3106A14S-6P (639)
with insert rotated 30° off normal position between contacts "A" and "F".

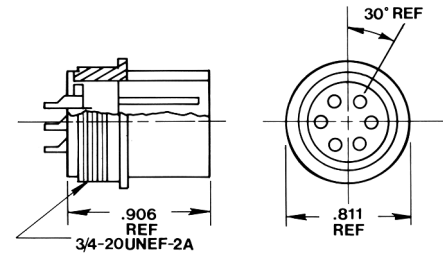

Convenience Outlets

Rated for duty at 15 amps. Provide 1000 VRMS dielectric withstanding voltage and 100 megohms insulation resistance. Will withstand 1000 cycles of use.

7-8649

Convenience plug

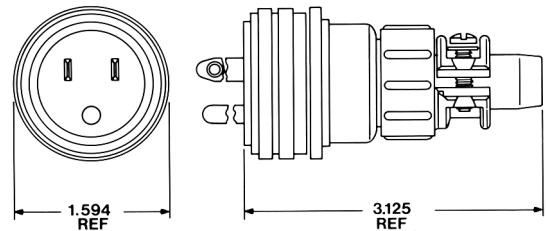

7-8648

Convenience outlet

7-8648-5

Convenience outlet with metal cap and chain

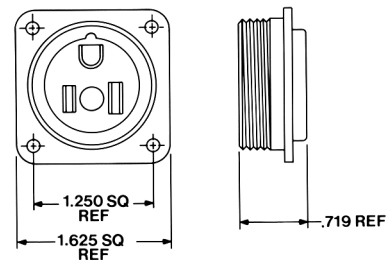

97 series accessories

cable clamps, bushing

Cable Clamp MS3057A Type

For jacketed cable or wires protected by tubing. Both clamping halves float for maximum strain relief. For unjacketed cable or wires, use corresponding MS3420 bushing. To order clamp with bushing, add -1 to the 97-number. Two telescoping bushings are furnished with shells sizes 24 and larger.

This cable clamp is die-cast zinc alloy and limited to the following plating variations:

- Std - olive drab/green chromate
- (621) - black chromate
- (676) - bright nickel
- (624) - green zinc alloy
- (689) - electroless nickel

Bushing MS3420

Rubber bushing specifically designed for MS3057A type cable clamp. Can also be used as a reducing bushing.

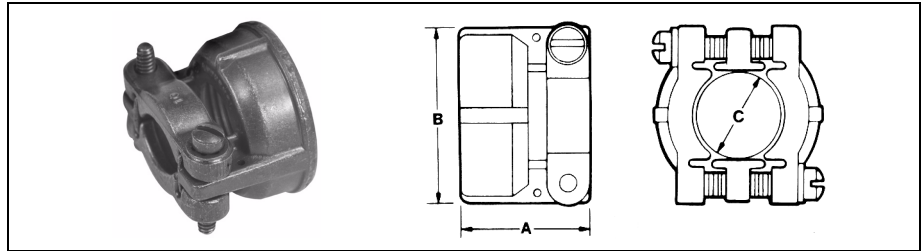

| Amphenol Part Number | Shell Size | Max. O.D. Cable | | A | | B | | C | | Threads |
|----------------------|---------------|-----------------|-------|-------|-------|-------|-------|-------|-------|-----------|
| | | Inch | mm | Inch | mm | Inch | mm | Inch | mm | |
| 97-3057-1004 | 10SL, 12S | 5/16 | 7.92 | .795 | 20.19 | .842 | 21.39 | 5/16 | 7.92 | 5/8-24 |
| 97-3057-1007 | 12SL, 14, 14S | 7/16 | 11.10 | .850 | 21.59 | .995 | 25.27 | 7/16 | 11.10 | 3/4-20 |
| 97-3057-1008 | 16, 16S | 9/16 | 14.27 | .920 | 23.37 | 1.120 | 28.45 | 9/16 | 14.27 | 7/8-20 |
| 97-3057-1010 | 18 | 5/8 | 15.88 | .920 | 23.37 | 1.216 | 30.89 | 5/8 | 15.88 | 1 -20 |
| 97-3057-1012 | 20, 22 | 3/4 | 19.05 | .927 | 23.55 | 1.403 | 35.64 | 3/4 | 19.05 | 1-3/16-18 |
| 97-3057-1016 | 24, 28 | 15/16 | 23.80 | 1.015 | 25.78 | 1.683 | 42.75 | 15/16 | 23.80 | 1-7/16-18 |
| 97-3057-1020 | 32 | 1-1/4 | 31.75 | 1.095 | 27.81 | 2.050 | 52.07 | 1-1/4 | 31.75 | 1-3/4-18 |
| 97-3057-1024 | 36 | 1-3/8 | 34.93 | 1.156 | 29.36 | 2.245 | 57.02 | 1-3/8 | 34.93 | 2 -18 |

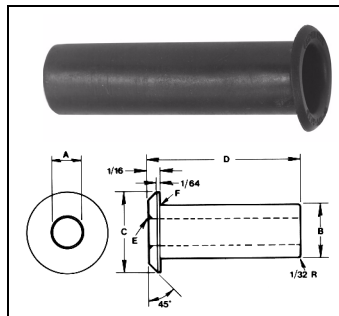

| Bushing Part Number | | A | | B | | C | | D | | E | | F | |
|---------------------|-------------|-------|-------|-------|-------|-------|-------|-------|-------|------|------|------|------|
| MS | Amphenol | Inch | mm | Inch | mm | Inch | mm | Inch | mm | Inch | mm | Inch | mm |
| 3420-3 | 9779-513-3 | .130 | 3.30 | .210 | 5.33 | .374 | 9.50 | 2.875 | 73.03 | 1/32 | .79 | 1/32 | .79 |
| 3420-4 | 9779-513-4 | .220 | 5.59 | .302 | 7.67 | .500 | 12.70 | 2.750 | 69.85 | 1/32 | .79 | 1/32 | .79 |
| 3420-6 | 9779-513-6 | .312 | 7.92 | .427 | 10.85 | .614 | 15.60 | 2.625 | 66.68 | 1/32 | .79 | 1/16 | 1.57 |
| 3420-8 | 9779-513-8 | .437 | 11.10 | .552 | 14.02 | .739 | 18.77 | 2.500 | 63.50 | 1/16 | 1.57 | 1/16 | 1.57 |
| 3420-10 | 9779-513-10 | .562 | 14.27 | .615 | 15.62 | .889 | 22.58 | 2.375 | 60.33 | 1/16 | 1.57 | 1/16 | 1.57 |
| 3420-12 | 9779-513-12 | .625 | 15.88 | .740 | 18.80 | 1.084 | 27.53 | 2.250 | 57.15 | 1/16 | 1.57 | 1/16 | 1.57 |
| 3420-16 | 9779-513-16 | .750 | 19.05 | .927 | 23.55 | 1.309 | 26.39 | 2.125 | 53.98 | 1/16 | 1.57 | 1/16 | 1.57 |
| 3420-20 | 9779-513-20 | .937 | 23.80 | 1.240 | 31.50 | 1.591 | 40.41 | 2.000 | 50.80 | 1/16 | 1.57 | 1/16 | 1.57 |
| 3420-24 | 9779-513-24 | 1.250 | 31.75 | 1.365 | 34.67 | 1.842 | 46.79 | 1.875 | 47.63 | 1/16 | 1.57 | 1/16 | 1.57 |

Cable Clamp AN3057

For jacketed cable or wires protected by tubing. Cable or wires should be centered in jaws of clamp for maximum grip. A vinyl or rubber bushing or sleeve may be used for centering. One resilient washer and two fiber washers are included with each clamp.

This cable clamp is die-cast zinc alloy and limited to the following plating variations:

- Std - olive drab/green chromate
- (621) - black chromate
- (676) - bright nickel
- (624) - green zinc alloy
- (689) - electroless nickel

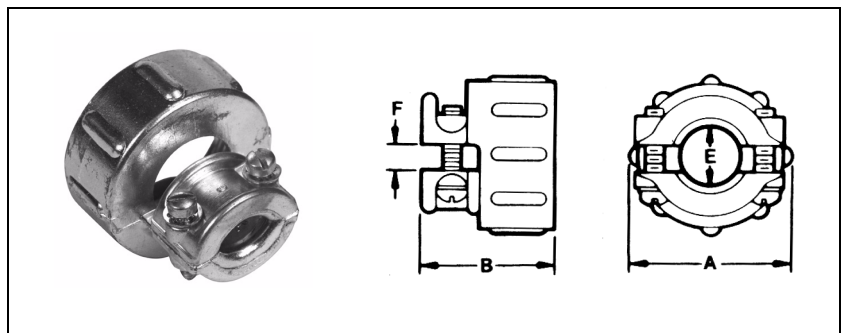

| AN Number | Fits Shell Size | Fits AN Fitting Size | Max O.D. Cable | | A | | B | | E | | F | | Threads | Weight Lbs. per 100 |
|------------|-----------------|----------------------|----------------|-------|---------|-------|--------|-------|-------|-------|-------|-------|-----------|---------------------|
| | | | Inch | mm | Inch | mm | Inch | mm | Inch | mm | Inch | mm | | |
| 97-3057-3 | 8S, 10S | 3 | 1/4 | 6.35 | 11/16 | 17.45 | 1 | 25.40 | 1/4 | 6.35 | 1/8 | 3.18 | 1/2-28 | 1.89 |
| 97-3057-4 | 10SL, 12S | 4 | 5/16 | 7.92 | 25/32 | 19.84 | 1 | 25.40 | 5/16 | 7.92 | 3/16 | 4.75 | 5/8-24 | 2.12 |
| 97-3057-6 | 12SL, 14, 14S | 6 | 7/16 | 11.10 | 15/16 | 23.80 | 1-5/64 | 27.38 | 7/16 | 11.10 | 3/16 | 4.75 | 3/4-20 | 2.94 |
| 97-3057-8 | 16, 16S | 8 | 9/16 | 14.27 | 1-1/16 | 26.97 | 1-1/8 | 28.58 | 9/16 | 14.27 | 9/32 | 7.14 | 7/8-20 | 3.44 |
| 97-3057-10 | 18 | 10 | 5/8 | 15.88 | 1-3/16 | 30.15 | 1-1/8 | 28.58 | 5/8 | 15.88 | 5/16 | 7.92 | 1 -20 | 4.72 |
| 97-3057-12 | 20, 22 | 12 | 3/4 | 19.05 | 1-3/8 | 34.93 | 1-3/16 | 30.15 | 3/4 | 19.05 | 5/16 | 7.92 | 1-3/16-18 | 6.10 |
| 97-3057-16 | 24, 28 | 16 | 15/16 | 23.80 | 1-5/8 | 41.28 | 1-5/16 | 33.32 | 15/16 | 23.80 | 3/8 | 9.53 | 1-7/16-18 | 8.71 |
| 97-3057-20 | 32 | 20 | 1-1/4 | 31.75 | 1-15/16 | 49.20 | 1-1/2 | 38.10 | 1-1/4 | 31.75 | 1/2 | 12.70 | 1-3/4-18 | 14.85 |
| 97-3057-24 | 36 | 24 | 1-3/8 | 34.93 | 2-3/16 | 55.55 | 1-9/16 | 39.67 | 1-3/8 | 34.93 | 19/32 | 15.06 | 2 -18 | 18.15 |
| 97-3057-28 | 40 | 28 | 1-5/8 | 41.28 | 2-1/2 | 63.50 | 1-9/16 | 39.67 | 1-5/8 | 41.28 | 21/32 | 16.66 | 2-1/4-16 | 21.50 |

97 series accessories

cable clamps, cont.

Step-Down Clamp 97-3057

Similar to AN3057 clamp, except step-down feature accommodates smaller cable.

This cable clamp is die-cast zinc alloy and limited to the following plating variations:

- Std - olive drab/green chromate
- (621) - black chromate
- (676) - bright nickel

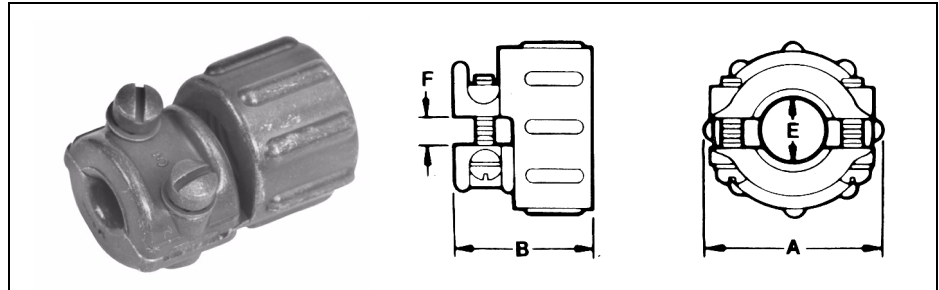

| Amphenol Part Number | Fits Shell Size | Fits AN Fitting Size | Max O.D. Cable | | A | | B | | E | | F | | Threads | Weight Lbs. per 100 |
|----------------------|-----------------|----------------------|----------------|-------|---------|-------|--------|-------|------|-------|------|------|-----------|---------------------|
| | | | Inch | mm | Inch | mm | Inch | mm | Inch | mm | Inch | mm | | |
| 97-3057-10-6 | 18 | 10 | 1/2 | 12.70 | 1-13/16 | 30.15 | 1-1/8 | 28.58 | 7/16 | 11.10 | 3/16 | 4.75 | 1 -20 | 3.94 |
| 97-3057-12-6 | 20, 22 | 12 | 1/2 | 12.70 | 1-3/8 | 34.93 | 1-3/16 | 30.15 | 7/16 | 11.10 | 3/16 | 4.75 | 1-3/16-18 | 4.40 |

9767 Water Resistant Cable Clamp

The 9767 assembly includes AN3057 clamp, a rubber bushing, a washer and the AN3055 adapter. To assure best results, the plug must be ordered with deviation (417), which supplies a W washer on the shoulder of the plug shell.

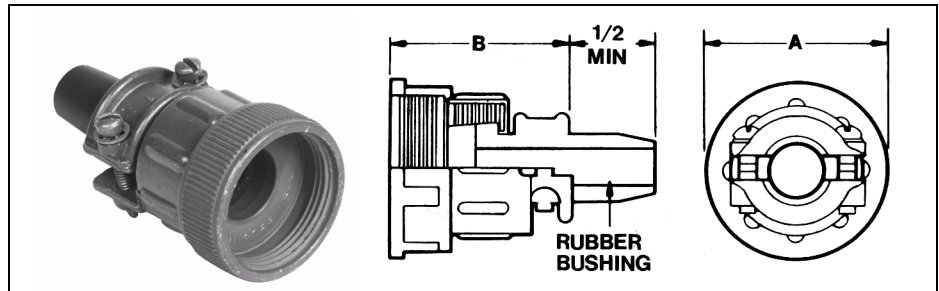

| Max. O.D. Cable | | Amphenol Part Number | Connector Size | A | | B | | Threads | Weight Lbs. per 100 |
|-----------------|-------|----------------------|----------------|---------|-------|---------|-------|-----------|---------------------|
| Inch | mm | | | Inch | mm | Inch | mm | | |
| 7/32 | 5.55 | 9767-12-4 | 10SL, 12S, 12 | 25/32 | 19.84 | 1-17/32 | 38.89 | 5/8-24 | 3.82 |
| | | 9767-14-4 | 12SL, 14S, 14 | 29/32 | 23.01 | 1-17/32 | 38.89 | 3/4-20 | 3.87 |
| | | 9767-16-4 | 16S, 16 | 1-1/16 | 26.97 | 1-17/32 | 38.89 | 7/8-20 | 4.00 |
| 11/32 | 8.73 | 9767-14-6 | 12SL, 14S, 14 | 29/32 | 23.01 | 1-19/32 | 40.46 | 3/4-20 | 5.54 |
| | | 9767-16-6 | 16S, 16 | 1-1/16 | 26.97 | 1-19/32 | 40.46 | 7/8-20 | 5.84 |
| | | 9767-18-6 | 18 | 1-3/16 | 30.15 | 1-19/32 | 40.46 | 1 -20 | 5.94 |
| 7/16 | 11.12 | 9767-16-8 | 16S, 16 | 1-1/16 | 26.97 | 1-19/32 | 40.46 | 7/8-20 | 6.92 |
| | | 9767-18-8 | 18 | 1-3/16 | 30.15 | 1-19/32 | 40.46 | 1 -20 | 7.10 |
| | | 9767-22-8 | 20, 22 | 1-3/8 | 34.93 | 1-19/32 | 40.46 | 1-3/16-18 | 7.27 |
| 9/16 | 14.29 | 9767-18-10 | 18 | 1-3/16 | 30.15 | 1-19/32 | 40.46 | 1 -20 | 8.79 |
| | | 9767-22-10 | 20, 22 | 1-3/8 | 34.93 | 1-19/32 | 40.46 | 1-3/16-18 | 8.97 |
| | | 9767-28-10 | 24, 28 | 1-5/8 | 41.28 | 1-17/32 | 38.89 | 1-7/16-18 | 9.12 |
| 11/16 | 17.46 | 9767-22-12 | 20, 22 | 1-3/8 | 34.93 | 1-21/32 | 42.06 | 1-3/16-18 | 12.65 |
| | | 9767-28-12 | 24, 28 | 1-5/8 | 41.28 | 1-21/32 | 42.06 | 1-7/16-18 | 12.86 |
| 27/32 | 21.43 | 9767-28-16 | 24, 28 | 1-5/8 | 41.28 | 1-25/32 | 45.24 | 1-7/16-18 | 14.95 |
| | | 9767-36-16 | 36 | 2-3/16 | 55.56 | 1-31/32 | 50.00 | 2 -18 | 16.36 |
| 1-1/32 | 26.19 | 9767-32-20 | 32 | 1-15/16 | 49.20 | 1-31/32 | 50.00 | 1-3/4-18 | 22.27 |

Cable Clamp for AN fittings

In selecting a cable clamp for a connection with AN fittings, the 9767 clamp with the adapter can be used.

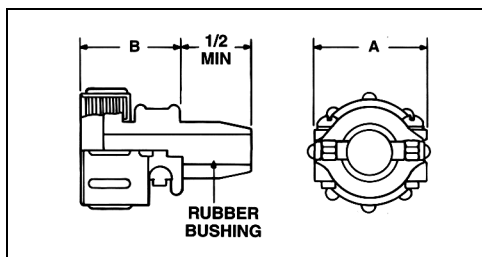

| Max. Cable O.D. | | Amphenol Part Number | Fitting Size | A | | B | | Threads | Weight Lbs. per 100 |
|-----------------|-------|----------------------|--------------|--------|-------|--------|-------|-----------|---------------------|
| Inch | mm | | | Inch | mm | Inch | mm | | |
| 7/32 | 5.54 | 9767-4 | 4 | 25/32 | 19.84 | 1 | 25.40 | 5/8-24 | 2.45 |
| 11/32 | 8.71 | 9767-6 | 6 | 29/32 | 23.01 | 1-5/64 | 27.38 | 3/4-20 | 3.94 |
| 7/16 | 11.10 | 9767-8 | 8 | 1-1/16 | 26.97 | 1-1/8 | 28.58 | 7/8-20 | 4.57 |
| 9/16 | 14.27 | 9767-10 | 10 | 1-3/16 | 30.15 | 1-1/8 | 28.58 | 1 -20 | 5.97 |
| 11/16 | 17.45 | 9767-12 | 12 | 1-3/8 | 34.93 | 1-3/16 | 30.15 | 1-3/16-18 | 7.85 |
| 27/32 | 21.41 | 9767-16 | 16 | 1-5/8 | 41.28 | 1-5/16 | 33.32 | 1-7/16-18 | 9.53 |

97 series accessories

metal protection caps

9760 Caps and Chain Assemblies

Fit MS and 97 type receptacles and plugs; provide protection against live circuits and keep out dirt and dust when connector is not in use.

Two styles are available: one with a stainless steel link chain, and one with a beaded chain. Both use the same caps and both have a cadmium olive drab finish.

Caps for receptacles have internal threads and are used on MS3102, MS3101, and MS3100 receptacles. A soft rubber disc seats on the connector shell, forming a water-tight joint.

Caps for plugs have external threads for use on all plugs where a coupling nut is provided (MS3106 and MS3108).

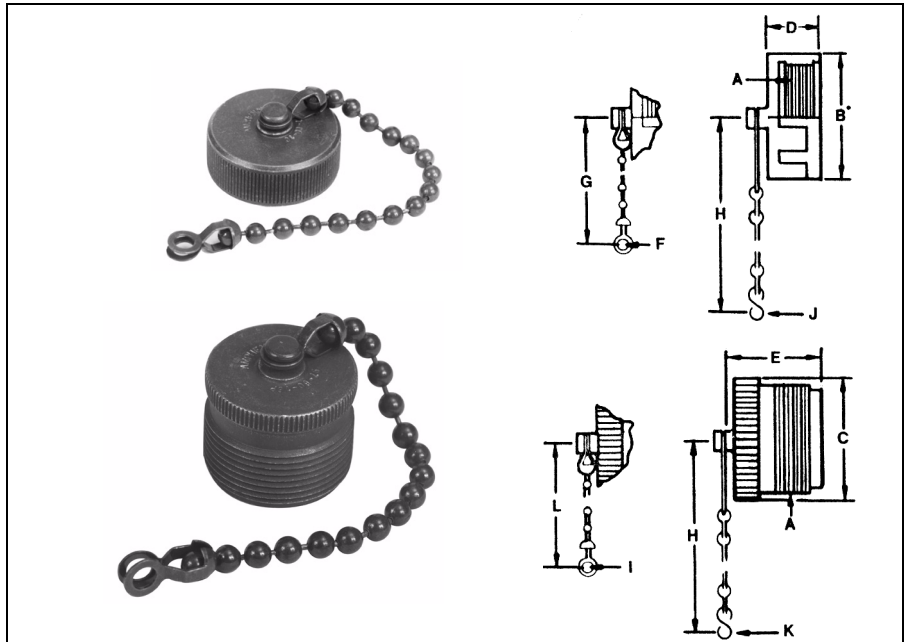

| For Receptacles† | | For Plugs† | | For Connector Size | A Threads | B* | | C | | D* | | E | |
|------------------|------------|------------|------------|--------------------|--------------|---------|-------|-------|-------|------|-------|-------|-------|
| Link Chain | Bead Chain | Link Chain | Bead Chain | | | Inch | mm | Inch | mm | Inch | mm | Inch | mm |
| 9760-908 | 9760-8 | 9760-808 | 9760-8P | 8S | 1/2-28 | 5/8 | 15.88 | 1/2 | 12.70 | 7/16 | 11.10 | 21.32 | 16.66 |
| 9760-910 | 9760-10 | 9760-810 | 9760-10P | 10S, 10SL | 5/8-24 | 13/16 | 20.62 | 5/8 | 15.88 | 7/16 | 11.10 | 21/32 | 16.66 |
| 9760-912 | 9760-12 | 9760-812 | 9760-12P | 12, 12S, 12SL | 3/4-20 | 15/16 | 23.80 | 3/4 | 19.05 | 7/16 | 11.10 | 27/32 | 21.41 |
| 9760-914 | 9760-14 | 9760-814 | 9760-14P | 14, 14S | 7/8-20 | 1-1/16 | 26.97 | 7/8 | 22.23 | 7/16 | 11.10 | 27/32 | 21.41 |
| 9760-916 | 9760-16 | 9760-816 | 9760-16P | 16, 16S | 1 -20 | 1-1/8 | 28.58 | 1 | 25.40 | 7/16 | 11.10 | 27/32 | 21.41 |
| 9760-918 | 9760-18 | 9760-818 | 9760-18P | 18 | 1-1/8-18 | 1-5/16 | 33.32 | 1-1/8 | 28.58 | 7/16 | 11.10 | 27/32 | 21.41 |
| 9760-920 | 9760-20 | 9760-820 | 9760-20P | 20 | 1-1/4-18 | 1-7/16 | 36.50 | 1-1/4 | 31.75 | 7/16 | 11.10 | 27/32 | 21.41 |
| 9760-922 | 9760-22 | 9760-822 | 9760-22P | 22 | 1-3/8-18 | 1-9/16 | 39.67 | 1-3/8 | 34.93 | 7/16 | 11.10 | 27/32 | 21.41 |
| 9760-924 | 9760-24 | 9760-824 | 9760-24P | 24 | 1-1/2-18 | 1-11/16 | 42.85 | 1-1/2 | 38.10 | 7/16 | 11.10 | 27/32 | 21.41 |
| 9760-928 | 9760-28 | 9760-828 | 9760-28P | 28 | 1-3/4-18 | 1-59/64 | 48.79 | 1-3/4 | 44.45 | 1/2 | 12.70 | 27/32 | 21.41 |
| 9760-932 | 9760-32 | 9760-832 | 9760-32P | 32 | 2 -18 | 2-3/16 | 55.55 | 2 | 50.80 | 1/2 | 12.70 | 27/32 | 21.41 |
| 9760-936 | 9760-36 | 9760-836 | 9760-36P | 36 | 2-1/4-16 | 2-7/16 | 61.90 | 2-1/4 | 57.15 | 1/2 | 12.70 | 27/32 | 21.41 |

| For Connector Size | F | | G | | H ± 1 Link | | I | | J | | K | | L | |
|--------------------|------|------|--------|--------|---------------|--------|------|------|------|------|------|------|---------|--------|
| | Inch | mm | Inch | mm | Inch | mm | Inch | mm | Inch | mm | Inch | mm | Inch | mm |
| 8S | .125 | 3.18 | 2-9/16 | 65.07 | 4.0 | 101.60 | .125 | 3.18 | .140 | 3.56 | .156 | 3.96 | 2-9/16 | 65.07 |
| 10S, 10SL | .125 | 3.18 | 2-9/16 | 65.07 | 4.0 | 101.60 | .125 | 3.18 | .140 | 3.56 | .156 | 3.96 | 2-13/16 | 71.44 |
| 12, 12S, 12SL | .125 | 3.18 | 2-9/16 | 65.07 | 4.5 | 114.30 | .125 | 3.18 | .140 | 3.56 | .156 | 3.96 | 3-13/16 | 96.84 |
| 14, 14S | .125 | 3.18 | 2-9/16 | 65.07 | 4.5 | 114.30 | .125 | 3.18 | .140 | 3.56 | .156 | 3.96 | 3-13/16 | 96.84 |
| 16, 16S | .167 | 4.24 | 4-5/8 | 117.48 | 4.5 | 114.30 | .167 | 4.24 | .140 | 3.56 | .156 | 3.96 | 4-5/8 | 117.48 |
| 18 | .167 | 4.24 | 4-5/8 | 117.48 | 4.5 | 114.30 | .167 | 4.24 | .140 | 3.56 | .156 | 3.96 | 4-5/8 | 117.48 |
| 20 | .167 | 4.24 | 4-5/8 | 117.48 | 5.0 | 127.00 | .167 | 4.24 | .140 | 3.56 | .187 | 4.75 | 4-5/8 | 117.48 |
| 22 | .167 | 4.24 | 4-5/8 | 117.48 | 5.0 | 127.00 | .167 | 4.24 | .140 | 3.56 | .187 | 4.75 | 4-5/8 | 117.48 |
| 24 | .167 | 4.24 | 4-5/8 | 117.48 | 5.5 | 139.70 | .167 | 4.24 | .171 | 4.34 | .187 | 4.75 | 4-5/8 | 117.48 |
| 28 | .167 | 4.24 | 4-5/8 | 117.48 | 7.75 | 196.85 | .167 | 4.24 | .171 | 4.34 | .187 | 4.75 | 4-5/8 | 117.48 |
| 32 | .190 | 4.83 | 5-3/4 | 146.05 | 7.75 | 196.85 | .260 | 6.60 | .187 | 4.75 | .218 | 5.54 | 5-3/4 | 146.05 |
| 36 | .190 | 4.83 | 5-3/4 | 146.05 | 7.75 | 196.85 | .260 | 6.60 | .187 | 4.75 | .218 | 5.54 | 5-3/4 | 146.05 |

* B dimension 1/16 inch less, and D dimension 1/64 inch less for screw machine parts, sizes 8 thru 22.

† Caps less chains are available. To order, add G to the part number; for example: 9760-8G.

97 series accessories

polyethylene protection caps

97121 Polyethylene Protective Dust Caps

Expendable polyethylene dust caps provide added protection for connectors during storage and handling, in assembling with other equipment, and after complete assembly into a finished apparatus. Protective caps cover threaded sections of plugs and receptacles, assure against damage to threads from any cause; permit low-cost, attractive coverings which protect contacts and the insulation from dust, dirt and handling damage.

To order connectors complete with caps:

When ordering new connectors, it is best to arrange to have the connectors arrive at your plant with caps assembled. This will assure you of protection against thread damage, dust and foreign matter in transit, in your stock and on your assembly line until the connectors are finally mated. To order connectors complete with protective caps assembled to both ends, specify (258) after the connector number; for example: MS3106A20-20P(258), or MS3102A20-20S(258).

To order caps separately:

Type 97121-4XXY - For engagement with internal threads of coupling rings.
Example of complete part number: 97121-408Y

Type 97121-4XXR - For engagement with external threads for coupling and fitting threads.
Example of complete part number: 97121-408R

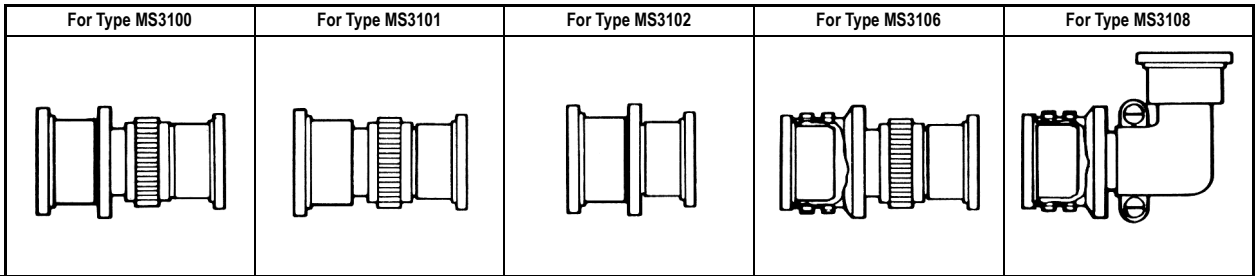

| Connector Size | For Type MS3100 | | For Type MS3101 | | For Type MS3102 | | For Type MS3106 | | For Type MS3108 | |
|----------------|-----------------|-----------------|-----------------|-----------------|-----------------|-----------------|-----------------|-----------------|-----------------|-----------------|
| | Mating End | Termination End | Mating End | Termination End | Mating End | Termination End | Mating End | Termination End | Mating End | Termination End |
| 8S | -408R | -408R | -408R | -408R | -408R | | -408Y | -408R | -408Y | -408R |
| 10S | -410R | -408R | -410R | -408R | -410R | -408R | -410Y | -408R | -410Y | -408R |
| 10SL | -410R | -410R | -410R | -410R | -410R | -410R | -410Y | -410R | -410Y | -410R |
| 12S-12 | -412R | -410R | -412R | -410R | -412R | | -412Y | -410R | -412Y | -410R |
| 14S-14 | -414R | -412R | -414R | -412R | -414R | -412R | -414Y | -412R | -414Y | -412R |
| 16S-16 | -416R | -414R | -416R | -414R | -416R | -414R | -416Y | -414R | -416Y | -414R |
| 18 | -418R | -416R | -418R | -416R | -418R | -416R | -418Y | -416R | -418Y | -416R |
| 20 | -420R | -420Y | -420R | -420Y | -420R | -418R | -420Y | -420Y | -420Y | -420Y |
| 22 | -422R | -420Y | -422R | -420Y | -422R | -420R | -422Y | -420Y | -422Y | -420Y |
| 24 | -424R | -424Y | -424R | -424Y | -424R | -422R | -424Y | -424Y | -424Y | -424Y |
| 28 | -428R | -424Y | -428R | -424Y | -428R | | -428Y | -424Y | -428Y | -424Y |
| 32 | -432R | -428R | -432R | -428R | -432R | | -432Y | -428R | -432Y | -428R |
| 36 | -436R | -432R | -436R | -432R | -436R | | -436Y | -432R | -436Y | -432R |
| 40 | -440R | -436R | -440R | -436R | -440R | | -440Y | -436R | -440Y | -436R |

97 series accessories

connector adapters

97-3055 Adapter

Used as reducing or extending bushing.
 Note: 97-3055 supersedes part number AN-3055.

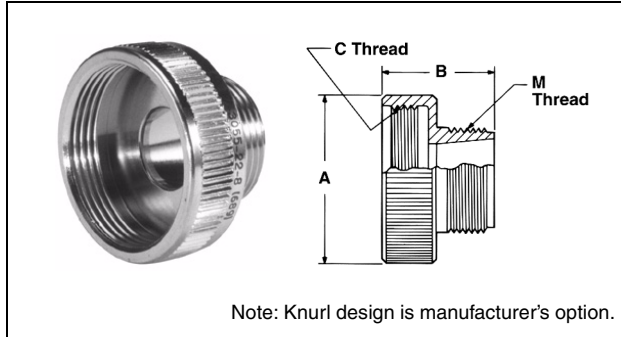

| Conduit Size | | AN Number | Used on Connector Size | A | | B | | C Threads | M Threads | Weight Lbs. per 100 |
|--------------|-------|---------------|------------------------|---------|-------|--------|-------|-----------|-----------|---------------------|
| Inch | mm | | | Inch | mm | Inch | mm | | | |
| 1/4 | 6.35 | 97-3055-12-4 | 12S, 12 | 25/32 | 18.24 | 7/8 | 22.23 | 5/8-24 | 5/8-24 | 1.37 |
| | | 97-3055-14-4 | 14S, 14 | 29/32 | 23.01 | 7/8 | 22.23 | 3/4-24 | 5/8-24 | 1.42 |
| 3/8 | 9.53 | 97-3055-14-6 | 14S, 14 | 29/32 | 23.01 | 7/8 | 22.23 | 3/4-20 | 3/4-20 | 1.60 |
| | | 97-3055-16-6 | 16S, 16 | 1-1/16 | 26.97 | 7/8 | 22.23 | 7/8-20 | 3/4-20 | 1.90 |
| | | 97-3055-18-6 | 18 | 1-3/16 | 30.15 | 7/8 | 22.23 | 1 -20 | 3/4-20 | 2.00 |
| 1/2 | 12.70 | 97-3055-16-8 | 16S, 16 | 1-1/16 | 26.97 | 7/8 | 22.23 | 7/8-20 | 7/8-20 | 2.35 |
| | | 97-3055-18-8 | 18 | 1-3/16 | 30.15 | 7/8 | 22.23 | 1 -20 | 7/8-20 | 2.53 |
| | | 97-3055-22-8 | 20, 22 | 1-3/8 | 34.93 | 7/8 | 22.23 | 1-3/16-18 | 7/8-20 | 2.70 |
| 5/8 | 17.88 | 97-3055-18-10 | 18 | 1-3/16 | 30.15 | 7/8 | 22.23 | 1 -20 | 1 -20 | 2.82 |
| | | 97-3055-22-10 | 20, 22 | 1-3/8 | 34.93 | 7/8 | 22.23 | 1-3/16-18 | 1 -20 | 3.00 |
| | | 97-3055-28-10 | 24, 28 | 1-5/8 | 41.28 | 7/8 | 22.23 | 1-7/16-18 | 1 -20 | 3.15 |
| 3/4 | 19.05 | 97-3055-22-12 | 20, 22 | 1-3/8 | 34.93 | 7/8 | 22.23 | 1-3/16-18 | 1-3/16-18 | 4.80 |
| | | 97-3055-28-12 | 24, 28 | 1-5/8 | 41.28 | 7/8 | 22.23 | 1-7/16-18 | 1-3/16-18 | 5.01 |
| 1 | 25.40 | 97-3055-28-16 | 24, 28 | 1-5/8 | 41.28 | 7/8 | 22.23 | 1-7/16-18 | 1-7/16-18 | 5.42 |
| | | 97-3055-32-16 | 32 | 1-15/16 | 49.20 | 15/16 | 23.80 | 1-3/4-18 | 1-7/16-18 | 5.60 |
| | | 97-3055-36-16 | 36 | 2-3/16 | 55.55 | 1-1/16 | 26.97 | 2 -18 | 1-7/16-18 | 5.73 |

97-3055-120 Adapter, Type II 97-3055-121 Adapter, Type I

Used to terminate pipe threads.

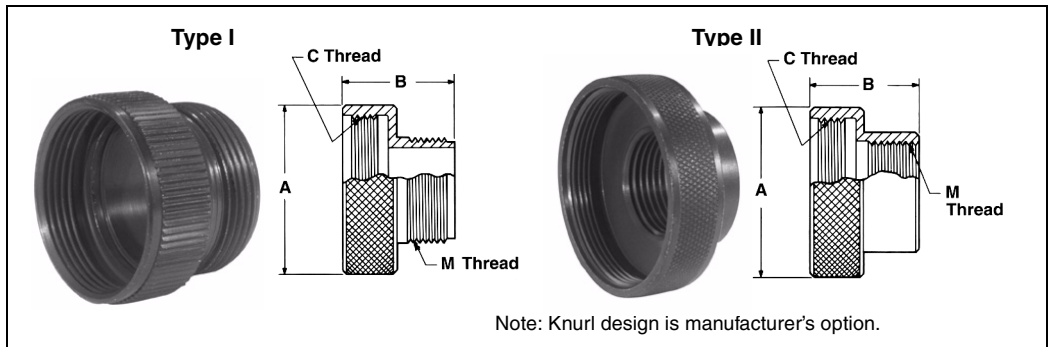

| M Thread Size | Type | Part Number | Shell Sizes | A Ref. | | B Max. | | C Thread |
|---------------|------|-------------------|-------------|---------|-------|--------|-------|-----------|
| | | | | Inch | mm | Inch | mm | |
| 1/2 NPT | II | 97-3055-120-18002 | 18, | 1-3/16 | 30.15 | 1-1/8 | 22.23 | 1 -20 |
| | | 97-3055-120-22002 | 20, 22 | 1-3/8 | 34.93 | 1-1/8 | 22.23 | 1-3/16-18 |
| | | 97-3055-120-28002 | 24, 28 | 1-5/8 | 41.28 | 1-1/8 | 22.23 | 1-7/16-18 |
| | I | 97-3055-121-18002 | 18, | 1-3/16 | 30.15 | 1-1/8 | 22.23 | 1 -20 |
| | | 97-3055-121-22002 | 20, 22 | 1-3/8 | 34.93 | 1-1/8 | 22.23 | 1-3/16-18 |
| | | 97-3055-121-28002 | 24, 28 | 1-5/8 | 41.28 | 1-1/8 | 22.23 | 1-7/16-18 |
| 3/4 NPT | II | 97-3055-120-28003 | 24-28 | 1-15/16 | 49.20 | 1-3/16 | 28.30 | 1-3/4 -18 |
| | I | 97-3055-121-28003 | 24-28 | 1-15/16 | 49.20 | 1-3/16 | 28.30 | 1-3/4 -18 |
| 3/4 NPT | II | 97-3055-120-32003 | 32 | 1-15/16 | 49.20 | 1-3/16 | 23.80 | 1-3/4 -18 |
| | I | 97-3055-121-32003 | 32 | 1-15/16 | 49.20 | 1-3/16 | 23.80 | 1-3/4 -18 |

97 series accessories

conduit box connectors, conduit coupling nuts

97-3064 Conduit Box Connector

Used with AN3066 locknut to form termination at conduit boxes or panel. May be used with AN3057 clamp to relieve strain on wiring cable terminals.

Note: 97-3064 supersedes AN3064.

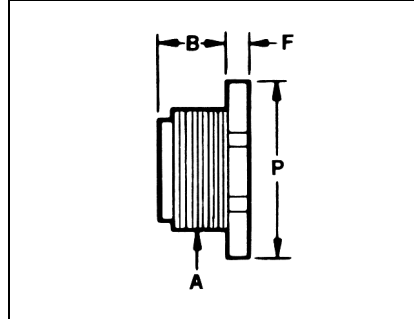

| Max. Conduit Size | | Part Number | Use Conduit Coupling Lock Nut Size | Use Conduit Coupling Nut Size | A Thread | B | | F | | P | | Weight Lbs. per 100 |
|-------------------|-------|-------------|------------------------------------|-------------------------------|-----------|-------|-------|------|------|--------|-------|---------------------|
| Inch | mm | | | | | Inch | mm | Inch | mm | Inch | mm | |
| 1/4 | 6.35 | 97-3064-4 | 97-3066-4 | 97-3054-4 | 5/8-24 | 5/8 | 19.05 | 1/8 | 3.18 | 13/16 | 20.62 | 1.75 |
| 3/8 | 9.53 | 97-3064-6 | 97-3066-6 | 97-3054-6 | 3/4-20 | 5/8 | 19.05 | 1/8 | 3.18 | 15/16 | 23.80 | 2.18 |
| 1/2 | 12.70 | 97-3064-8 | 97-3066-8 | 97-3054-8 | 7/8-20 | 11/16 | 22.23 | 3/16 | 4.75 | 1-1/16 | 26.97 | 3.15 |
| 5/8 | 17.88 | 97-3064-10 | 97-3066-10 | 97-3054-10 | 1 -20 | 11/16 | 22.23 | 3/16 | 4.75 | 1-1/4 | 31.75 | 3.94 |
| 3/4 | 19.05 | 97-3064-12 | 97-3054-12 | 97-3054-12 | 1-3/16-18 | 11/16 | 22.23 | 3/16 | 4.75 | 1-3/8 | 34.93 | 4.98 |

97-3054 Conduit Coupling Nut

Note: 97-3054 supersedes AN3054.

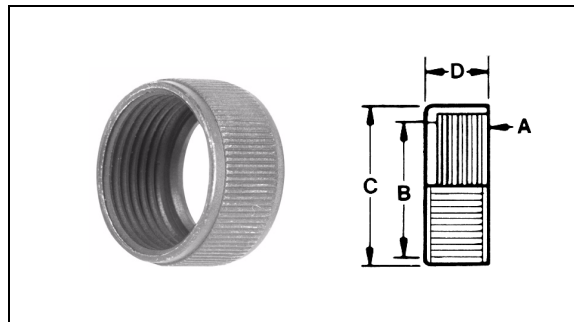

| Max. Conduit Size | | Part Number | MS Connector Size | AN Conduit Fitting Size | A Thread | B | | C | | D | | Weight Lbs. per 100 |
|-------------------|-------|-------------|-------------------|-------------------------|-----------|-------|-------|--------|-------|------|-------|---------------------|
| Inch | mm | | | | | Inch | mm | Inch | mm | Inch | mm | |
| 3/8 | 9.53 | 97-3054-6 | 14, 14S | 6 | 3/4-20 | .583 | 14.81 | 27/32 | 21.41 | 7/16 | 11.10 | .70 |
| 5/8 | 17.88 | 97-3054-10 | 18 | 10 | 1 -20 | .833 | 21.16 | 1-1/8 | 28.58 | 7/16 | 11.10 | 1.31 |
| 3/4 | 19.05 | 97-3054-12 | 20, 22 | 12 | 1-3/16-18 | .933 | 23.70 | 1-5/16 | 33.32 | 7/16 | 11.10 | 1.60 |
| 1 | 25.40 | 97-3054-16 | 24, 28 | 16 | 1-7/16-18 | 1.278 | 32.46 | 1-9/16 | 39.67 | 7/16 | 11.10 | 1.90 |

97-3066 Conduit Coupling Lock Nut

Note: 97-3066 supersedes AN3066.

| Conduit Size | | Part Number | A Thread | F | | P | | Q | | Weight Lbs. per 100 |
|--------------|-------|-------------|-----------|------|------|--------|-------|---------|-------|---------------------|
| Inch | mm | | | Inch | mm | Inch | mm | Inch | mm | |
| 1/4 | 6.35 | 97-3066-4 | 5/8-24 | 1/8 | 3.18 | 13/16 | 20.62 | 15/16 | 23.80 | .36 |
| 3/8 | 9.53 | 97-3066-6 | 3/4-20 | 1/8 | 3.18 | 15/16 | 23.80 | 1-3/32 | 27.76 | .41 |
| 1/2 | 12.70 | 97-3066-8 | 7/8-20 | 3/16 | 4.75 | 1-1/16 | 26.97 | 1-15/64 | 31.34 | .72 |
| 5/8 | 15.88 | 97-3066-10 | 1 -20 | 3/16 | 4.75 | 1-1/4 | 31.75 | 1-7/16 | 34.21 | .86 |
| 3/4 | 19.05 | 97-3066-12 | 1-3/16-18 | 3/16 | 4.75 | 1-3/8 | 34.93 | 1-19/32 | 40.46 | 1.01 |

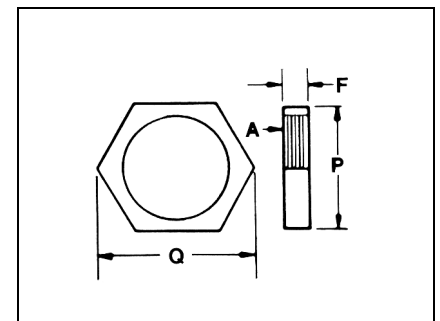

97 series accessories

sealing gaskets

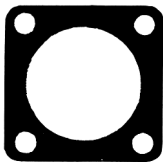
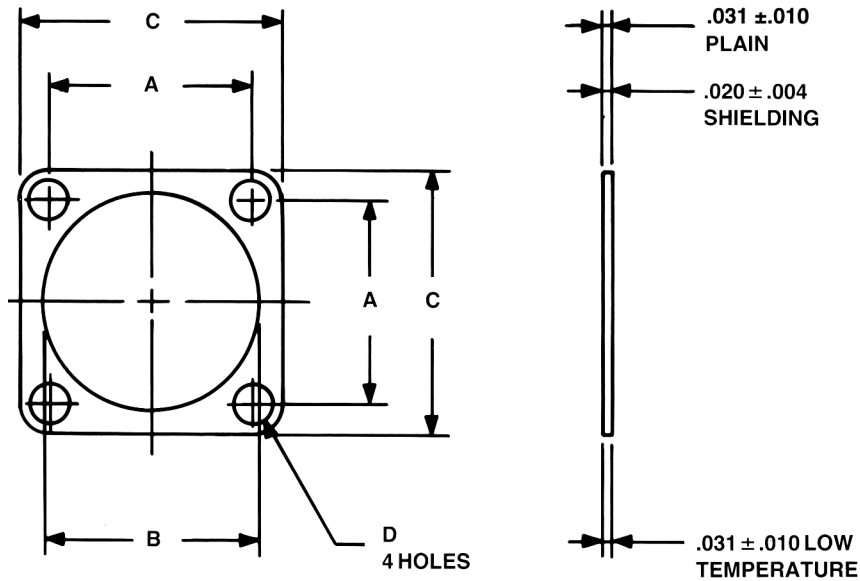

The Amphenol® plain flat gasket of synthetic rubber material is provided to take complete advantage of waterproof and pressure sealing features. It is for use with the flange mounted receptacle.

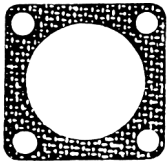

This flat gasket is provided to give the maximum in connector performance. Its special feature is in providing the maximum radio shielding under difficult conditions of high receiver sensitivity and low signal strength while retaining the sealing characteristics of the plain gasket. This gasket is for use with the flange mounting receptacle.

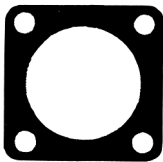

This gasket is provided for applications where the major requirement is resistance to the injurious effects of extremely low temperature. Even at temperatures as low as -67°F this gasket retains its resiliency and will seal a pressure differential of 30 psi.

| Shell Size | Installation Dimensions | | | | Order Data | | |
|------------|-------------------------|---------------------------|---------------------------|-----------------|-------------|--------------|-----------------|
| | A $\pm .010$ | B $+ .016$ $- .000$ | C $+ .016$ $- .000$ | D $\pm .010$ | Plain | Shielding | Low Temperature |
| 8S | .594 | .500 | .875 | .172 | 10-40450-8 | 10-40450-8S | 10-36675-8 |
| 10S | .719 | .625 | 1.000 | .172 | 10-40450-10 | 10-40450-10S | 10-36675-10 |
| 10SL | .719 | .625 | 1.000 | .172 | 10-40450-10 | 10-40450-10S | 10-36675-10 |
| 12S | .813 | .750 | 1.094 | .172 | 10-40450-12 | 10-40450-12S | 10-36675-12 |
| 12 | .813 | .750 | 1.094 | .172 | 10-40450-12 | 10-40450-12S | 10-36675-12 |
| 14S | .906 | .875 | 1.188 | .172 | 10-40450-14 | 10-40450-14S | 10-35575-14 |
| 14 | .906 | .875 | 1.188 | .172 | 10-40450-14 | 10-40450-14S | 10-36675-14 |
| 16S | .969 | 1.000 | 1.281 | .172 | 10-40450-16 | 10-40450-16S | 10-36675-16 |
| 16 | .969 | 1.000 | 1.281 | .172 | 10-40450-16 | 10-40450-16S | 10-36675-16 |
| 18 | 1.063 | 1.125 | 1.375 | .203 | 10-40450-18 | 10-40450-18S | 10-36675-18 |
| 20 | 1.156 | 1.250 | 1.500 | .203 | 10-40450-20 | 10-40450-20S | 10-36675-20 |
| 22 | 1.250 | 1.375 | 1.625 | .203 | 10-40450-22 | 10-40450-22S | 10-36675-22 |
| 24 | 1.375 | 1.500 | 1.750 | .203 | 10-40450-24 | 10-40450-24S | 10-36675-24 |
| 28 | 1.563 | 1.750 | 2.000 | .203 | 10-40450-28 | 10-40450-28S | 10-36675-28 |
| 32 | 1.750 | 2.000 | 2.250 | .219 | 10-40450-32 | 10-40450-32S | 10-36675-32 |
| 36 | 1.938 | 2.188 | 2.500 | .219 | 10-40450-36 | 10-40450-36S | 10-36675-36 |
| 40 | 2.188 | 2.438 | 2.750 | .219 | 10-40450-40 | 10-40450-40S | 10-36675-40 |

All dimensions for reference only.

97 series accessories

dummy receptacles

97-181 Dummy Receptacle Shells

Same as MS receptacle less insert and contacts.
Used to anchor MS plugs when not in use.

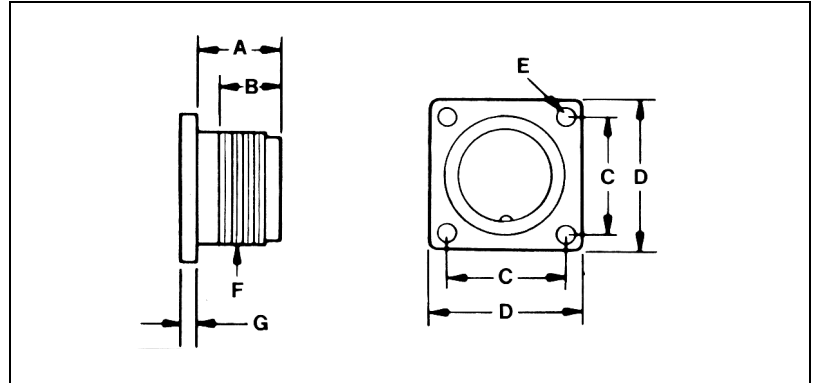

| For Connector Size | Amphenol Part Number | A | | B | | C | | D | | E Dia., | | F Thread | G Mounting Flange Thickness | | | | Weight Lbs. per 100 |
|--------------------|----------------------|------|-------|------|-------|-------|-------|-------|-------|---------|------|----------|-----------------------------|------|------|------|---------------------|
| | | Inch | mm | Inch | mm | Inch | mm | Inch | mm | Inch | mm | | Max. | | Min. | | |
| | | | | | | | | | | | | | Inch | mm | Inch | mm | |
| 10S | 97-181-10S | .562 | 14.27 | .375 | 9.53 | .719 | 18.26 | 1.000 | 25.40 | .120 | 3.05 | 5/8-24 | .156 | 3.96 | .078 | 1.98 | 1.10 |
| 12S | 97-181-12S | .562 | 14.27 | .375 | 9.53 | .812 | 20.62 | 1.094 | 27.79 | .120 | 3.05 | 3/4-20 | .156 | 3.96 | .078 | 1.98 | 1.73 |
| 14S | 97-181-14S | .562 | 14.27 | .375 | 9.53 | .906 | 23.01 | 1.188 | 30.18 | .120 | 3.05 | 7/8-20 | .156 | 3.96 | .078 | 1.98 | 2.00 |
| 16S | 97-181-16S | .562 | 19.05 | .375 | 9.53 | .969 | 24.61 | 1.281 | 32.54 | .120 | 3.05 | 1 -20 | .156 | 3.96 | .078 | 1.98 | 2.35 |
| 16 | 97-181-16 | .750 | 19.05 | .625 | 15.88 | .969 | 24.61 | 1.281 | 32.54 | .120 | 3.05 | 1 -20 | .156 | 3.96 | .078 | 1.98 | 3.10 |
| 18 | 97-181-18 | .750 | 19.05 | .625 | 15.88 | 1.062 | 26.97 | 1.375 | 34.93 | .120 | 3.05 | 1-1/8-16 | .203 | 5.16 | .094 | 2.39 | 3.18 |
| 20 | 97-181-20 | .750 | 19.05 | .625 | 15.88 | 1.156 | 29.36 | 1.500 | 38.10 | .120 | 3.05 | 1-1/4-18 | .203 | 5.16 | .094 | 2.39 | 3.80 |
| 22 | 97-181-22 | .750 | 19.05 | .625 | 15.88 | 1.250 | 31.75 | 1.625 | 41.28 | .120 | 3.05 | 1-3/8-18 | .203 | 5.16 | .094 | 2.39 | 4.50 |
| 24 | 97-181-24 | .812 | 20.62 | .625 | 15.88 | 1.375 | 34.92 | 1.750 | 44.45 | .147 | 3.73 | 1-1/2-18 | .203 | 5.16 | .094 | 2.39 | 5.00 |
| 28 | 97-181-28 | .812 | 20.62 | .625 | 15.88 | 1.562 | 39.67 | 2.000 | 50.80 | .147 | 3.73 | 1-3/4-18 | .203 | 5.16 | .094 | 2.39 | 6.58 |
| 32 | 97-181-32 | .875 | 22.23 | .625 | 15.88 | 1.750 | 44.45 | 2.250 | 57.15 | .173 | 4.39 | 2 -18 | .359 | 9.12 | .125 | 3.18 | 9.75 |