

PRODUCT LINE CARD

INCLUDING DEVELOPMENT TOOLS

SECOND QUARTER 2002

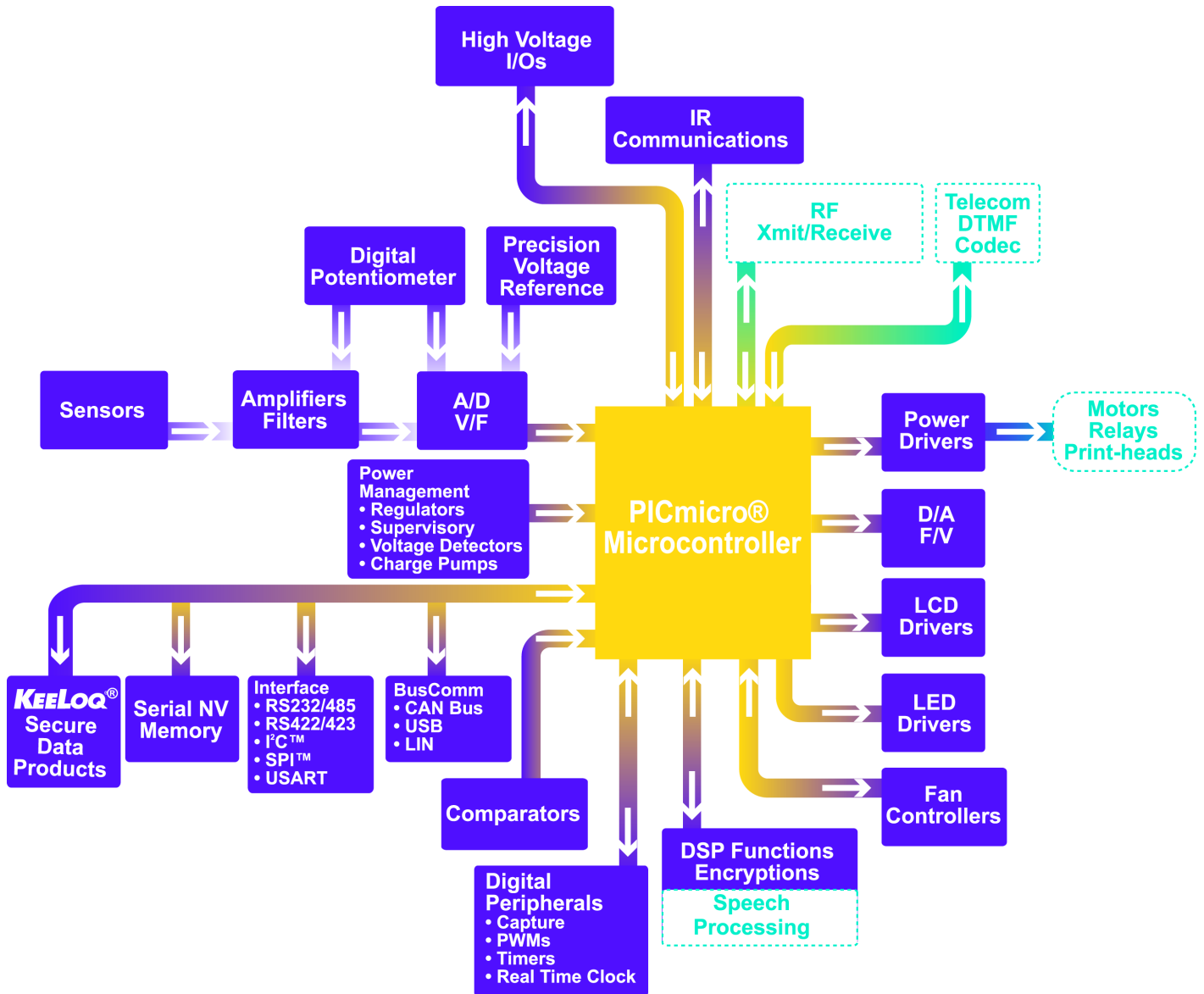

MICROCHIP
The Embedded Control Solutions Company[®]

Product Profile

PICmicro[®] Microcontrollers

Microchip's PICmicro[®] family of microcontrollers combine high performance, low cost and small package size to offer the best price/performance ratio in the industry. Based on a powerful RISC core, the PICmicro architecture provides users an easy migration path from 8 to 84 pins among all families with little or no code change required. Advanced features available are:

- sophisticated timing peripherals
- embedded analog-to-digital converters (ADCs)
- extended instruction/data memory
- communications peripherals (I²C[™]/SPI[™]/USB/CAN and USARTs)
- In-Circuit Serial Programming[™] technology (ICSP[™])
- memory technology including one-time programmable (OTP), reprogrammable (FLASH) and read-only memory (ROM)
- advanced analog features (PBOR, PLVD, DAC, VREF, Op Amps and PSMC)

Analog & Interface Products

Microchip offers a wide range of analog and related products:

- *Linear and Mixed-Signal.* ADCs/DACs, digital potentiometers, op amps and comparators.
- *Power Management.* LDO and switching regulators, charge pumps, voltage references, CPU/system supervisors and voltage detectors, battery chargers and power MOSFET drivers.
- *Thermal Management.* Temperature sensors (logic output, voltage output, and serial output), brushless DC fan controllers, and fan fault detectors.
- *Interface.* High-performance peripheral devices supporting CAN and infrared (including IrDA[®] protocol handling).

Secure Data Products

Microchip's KEELOQ[®] family of code hopping devices provides "rock solid" security for remote-keyless-entry and authentication applications. Devices using the KEELOQ code hopping algorithm combine high security, a small package outline and a very low cost to make this an ideal solution for unidirectional RKE systems. The KEELOQ code hopping technology creates a high degree of security using a long code word length together with encryption and synchronization techniques.

Microperipheral Products

- **Serial EEPROMs and Non-Volatile Memories.** Microchip offers one of the broadest selections of serial EEPROMs in a variety of: densities (from 128 bits up to 256K bits), operating voltages (down to 1.8V), bus interface protocols (Microwire[®], I²C and SPI[™]), operating temperature ranges and space-saving packages, including the world's smallest EEPROM (in a 5-lead SOT-23). With a technology leadership position of 3 MHz bus rate performance, Microchip's EEPROMs are used in auto identification and plug-and-play applications for PC monitors, memory modules and communications equipment.
- **RFID.** The microID[®] family of radio frequency identification (RFID) tag chips provides the industry's highest performance solution for the low-cost, passive RFID tag market, including access control, industrial and animal tagging applications.

dsPIC[™] Digital Signal Controllers

The dsPIC[™] family of Digital Signal Controllers features a fully-implemented digital signal processor (DSP) engine, 30 MIPS non-pipe lined performance, C compiler friendly design, and a familiar microcontroller architecture and design environment. These 20 new dsPIC30FXXX 16-bit FLASH microcontrollers provide the industry's highest performance and target motor control and power conversion, sensor processing, and general-purpose applications.

rfPIC[™] Microcontrollers and rfHCS Devices

The rfPIC[™] family significantly eases the radio frequency (RF) design process while reducing component count and board space. The first devices feature an integrated 315/433 MHz ASK/FSK transmitter. These low-power single-chip RF solutions are the first of many planned devices in the new family which targets RF connectivity for high-volume embedded control applications, such as remote sensing, remote control, toys, security and access control.

Development Systems

Microchip offers a full range of microcontroller development systems, including the MPLAB[®] ICE universal in-circuit emulators; PRO MATE[®] II full-featured device programmer; PICSTART[®] low-cost development system; MPLAB Integrated Development Environment; MPLAB C Compiler; the MPLAB ICD In-Circuit Debugger, and the PICDEM.net[™] Internet/Ethernet Demonstration Board. Microchip has shipped more than 200,000+ development systems worldwide.

ANALOG/INTERFACE PRODUCTS

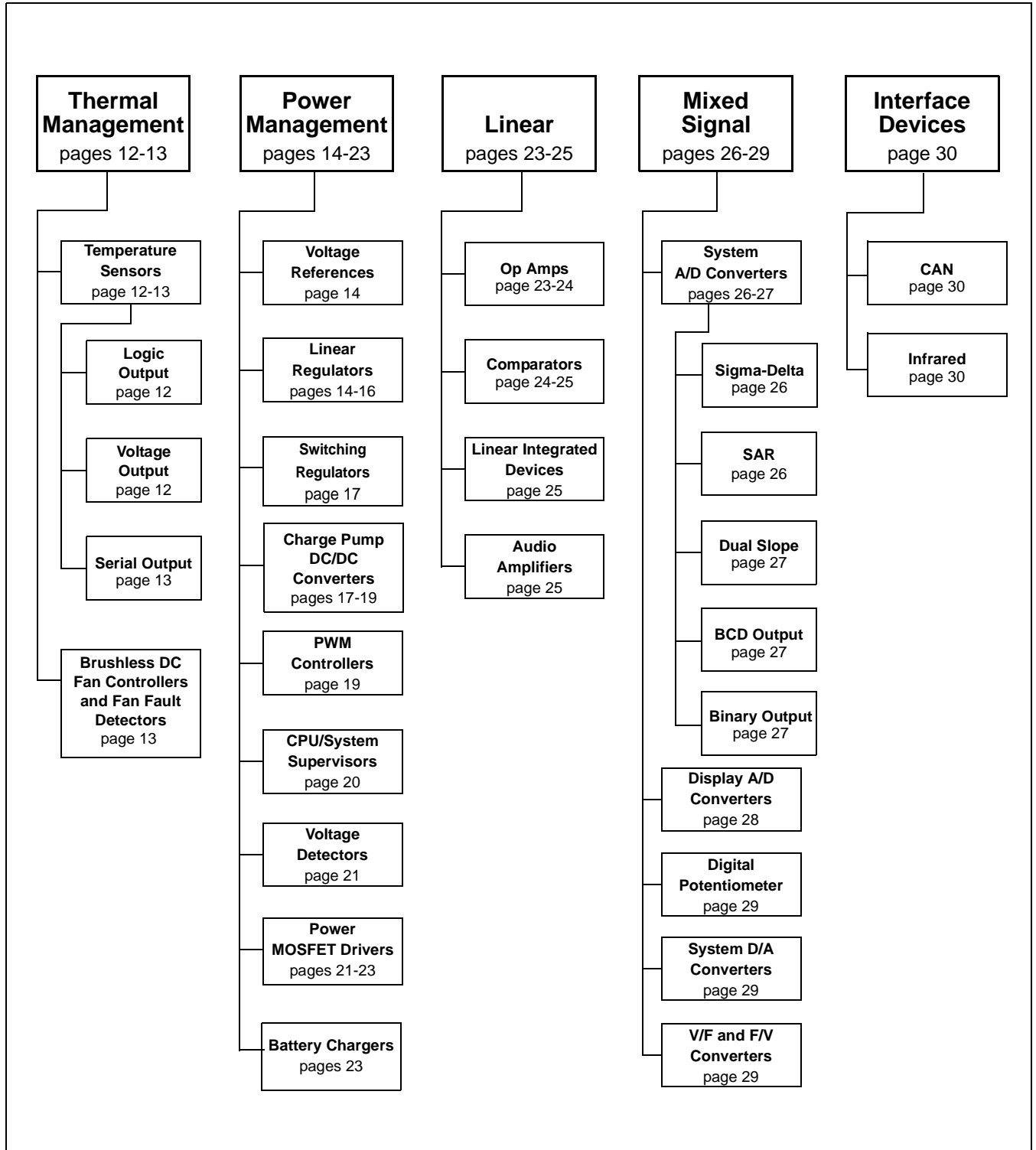

ABBREVIATIONS

ADC	Analog-to-Digital Converter
ASK	Amplitude Shift Key
AUSART	Addressable USART
BOR	Brown-Out Detection/Reset
CAP	Capture
CCP	Capture/Compare/PWM
CRC	Cyclic Redundancy Check
DAC	Digital-to-Analog Converter
3 ϕ	3 Phase PWMs
4 ϕ	4 Phase PWMs
E2	EEPROM (Reprogrammable)
ECCP	Enhanced Capture/Compare/PWM
EMA	External Memory Addressing
FSK	Frequency Shift Key
I ² C	Inter-integrated Circuit Bus
ICSP™	In-Circuit Serial Programming™
ICD	In-Circuit Debug

ABBREVIATIONS

LVD	Low Voltage Detection
LIN XCVR	Local Interconnection Network Transceiver
MI ² C/SPI	Master I ² C/SPI
OTP	One-Time Programmable
PBOR	Programmable Brown-Out Detection/Reset
PLVD	Programmable Low-Voltage Detection
PSMC	Programmable Switch Mode Controller
PSP	Parallel Slave Port
PWM	Pulse Width Modulator
SLAC	Slope A/D Converter, up to 16 bits
SMB	System Management Bus
SPI	Serial Peripheral Interface
USART	Universal Synchronous/Asynchronous Receiver/Transmitter
USB	Universal Serial Bus
VREF	Voltage Reference
WDT	Watchdog Timer
√P	Programmable

CURRENT PICmicro[®] PRODUCTS

PICmicro [®] MICROCONTROLLER FAMILY PRODUCTS																		
Product	Program Memory			EEPROM Data Memory Bytes	RAM Bytes	I/O Pins	Packages	Analog		Digital			Max. Speed MHz	ICSP™	BOR/PBOR	PLVD	CCP/ECCP	Other Features
	Bytes	OTP/FLASH Words	ROM Words					8-Bit ADC Channels	Comparators	PWM 10-Bit	Timers/WDT	Serial I/O						
PIC12CXXX: 400ns Instruction Execution, 33/35 Instructions, 4MHz Internal Oscillator, 4/5 Oscillator Selections																		
PIC12C508A#	768	512x12	—	—	25	6	8P, 8SM, 8JW, 8SN, 8MF	—	—	—	1-8 bit, 1-WDT	—	4	✓	—	—	—	25mA source/sink per I/O
PIC12C509A#	1536	1024x12	—	—	41	6	8P, 8SM, 8JW, 8SN, 8MF	—	—	—	1-8 bit, 1-WDT	—	4	✓	—	—	—	25mA source/sink per I/O
PIC12CR509A	1536	—	1024x12	—	41	6	8P, 8SM, 8SN	—	—	—	1-8 bit, 1-WDT	—	4	—	—	—	—	25mA source/sink per I/O
PIC12CE518	768	512x12	—	16	25	6	8P, 8SM, 8JW, 8SN	—	—	—	1-8 bit, 1-WDT	—	4	✓	—	—	—	25mA source/sink per I/O
PIC12CE519	1536	1024x12	—	16	41	6	8P, 8SM, 8JW, 8SN	—	—	—	1-8 bit, 1-WDT	—	4	✓	—	—	—	25mA source/sink per I/O
PIC12C671#	1792	1024x14	—	—	128	6	8P, 8SM, 8JW, 8MF	4	—	—	1-8 bit, 1-WDT	—	10	✓	—	—	—	25mA source/sink per I/O
PIC12C672#	3584	2048x14	—	—	128	6	8P, 8SM, 8JW, 8MF	4	—	—	1-8 bit, 1-WDT	—	10	✓	—	—	—	25mA source/sink per I/O
PIC12CE673	1792	1024x14	—	16	128	6	8P, 8JW	4	—	—	1-8 bit, 1-WDT	—	10	✓	—	—	—	25mA source/sink per I/O
PIC12CE674	3584	2048x14	—	16	128	6	8P, 8JW	4	—	—	1-8 bit, 1-WDT	—	10	✓	—	—	—	25mA source/sink per I/O
PIC12FXXX FLASH MCUs: Upwardly compatible with PIC12CXXX, 200ns Instruction Execution, 35 Instructions, 4MHz Internal Oscillator, 5 Oscillator Selections																		
PIC12F629	1792 (FLASH)	1024x14 (FLASH)	—	128	64	6	8P, 8SN, 8MF	—	1	—	1-8 bit, 1-16 bit, 1-WDT	—	20	3	3	—	—	4 MHz Internal Oscillator, ICD
PIC12F675	1792 (FLASH)	1024x14 (FLASH)	—	128	64	6	8P, 8SN, 8MF	4 (10-bit)	1	—	1-8 bit, 1-16 bit, 1-WDT	—	20	3	3	—	—	4 MHz Internal Oscillator, ICD
PIC16C5X: 100-200ns Instruction Execution, 33 Instructions, 4/5 Oscillator Selections																		
PIC16C54C	768	512x12	—	—	25	12	18P, 18JW, 18SO, 20SS	—	—	—	1-8 bit, 1-WDT	—	40	—	—	—	—	20mA source and 25mA sink per I/O
PIC16CR54C	768	—	512x12	—	25	12	18P, 18SO, 20SS	—	—	—	1-8 bit, 1-WDT	—	20	—	—	—	—	20mA source and 25mA sink per I/O
PIC16C55A	768	512x12	—	—	24	20	28P, 28JW, 28SP, 28SO, 28SS	—	—	—	1-8 bit, 1-WDT	—	40	—	—	—	—	20mA source and 25mA sink per I/O
PIC16C56A	1536	1024x12	—	—	25	12	18P, 18JW, 18SO, 20SS	—	—	—	1-8 bit, 1-WDT	—	40	—	—	—	—	20mA source and 25mA sink per I/O
PIC16CR56A	1536	—	1024x12	—	25	12	18P, 18SO, 20SS	—	—	—	1-8 bit, 1-WDT	—	20	—	—	—	—	20mA source and 25mA sink per I/O
PIC16C57C	3072	2048x12	—	—	72	20	28P, 28JW, 28SP, 28SO, 28SS	—	—	—	1-8 bit, 1-WDT	—	40	—	—	—	—	20mA source and 25mA sink per I/O
PIC16CR57C	3072	—	2048x12	—	72	20	28P, 28SP, 28SO, 28SS	—	—	—	1-8 bit, 1-WDT	—	20	—	—	—	—	20mA source and 25mA sink per I/O
PIC16C58B	3072	2048x12	—	—	73	12	18P, 18JW, 18SO, 20SS	—	—	—	1-8 bit, 1-WDT	—	40	—	—	—	—	20mA source and 25mA sink per I/O
PIC16CR58B	3072	—	2048x12	—	73	12	18P, 18SO, 20SS	—	—	—	1-8 bit, 1-WDT	—	20	—	—	—	—	20mA source and 25mA sink per I/O
PIC16C505	1536	1024x12	—	—	72	12	14P, 14JW, 14SL	—	—	—	1-8 bit, 1-WDT	—	20	✓	—	—	—	25mA source/sink per I/O, 4MHz internal oscillator
PIC16HV540	768	512x12	—	—	25	12	18P, 18JW, 18SO, 20SS	—	—	—	1-8 bit, 1-WDT	—	20	—	✓	—	—	8 high voltage (15V) I/Os, 4 deep stack, 5 I/O with wake-up on change, Extended VDD (3.5 to 15 V)
PIC16CXXX: Upwardly Compatible with PIC16C5X/PIC12CXXX, 4–12 Interrupts, 100-500ns Instruction Execution, 35 Instructions, 4/5 Oscillator Selections																		
PIC14000	7168	4096x14	—	—	192	20	28SP, 28SO, 28SS, 28JW	8 SLAC	2	—	1-16 bit, 1-8 bit, 1-WDT	I ² C/SMB	20	✓	—	—	—	25mA source/sink, internal oscillator, temperature sensor, VREF, Prog. Reference Generator
PIC16C554	896	512x14	—	—	80	13	18P, 18SO, 18JW, 20SS	—	—	—	1-8 bit, 1-WDT	—	20	✓	—	—	—	25mA source/sink per I/O
PIC16C558	3584	2048x14	—	—	128	13	18P, 18SO, 18JW, 20SS	—	—	—	1-8 bit, 1-WDT	—	20	✓	—	—	—	25mA source/sink per I/O
PIC16C62B	3584	2048x14	—	—	128	22	28SP, 28SO, 28SS, 28JW, 28ML	—	—	1	1-16 bit, 2-8 bit, 1-WDT	I ² C/SPI™	20	✓	✓	—	1	25mA source/sink per I/O

PICmicro® MICROCONTROLLER FAMILY PRODUCTS

Product	Program Memory			EEPROM Data Memory Bytes	RAM Bytes	I/O Pins	Packages	Analog		Digital			Max. Speed MHz	ICSP™	BOR/PBOR	PLVD	CCP/ECCP	Other Features
	Bytes	OTP/FLASH Words	ROM Words					8-Bit ADC Channels	Comparators	PWM 10-Bit	Timers/WDT	Serial I/O						
PIC16CXXX: Upwardly Compatible with PIC16C5X/PIC12CXXX, 4–12 Interrupts, 100-500ns Instruction Execution, 35 Instructions, 4/5 Oscillator Selections (continued)																		
PIC16C63A	7168	4096x14	—	—	192	22	28SP, 28SO, 28SS, 28JW, 28ML	—	—	2	1-16 bit, 2-8 bit, 1-WDT	USART/I ² C/SPI	20	✓	✓	—	2	25mA source/sink per I/O
PIC16CR63	7168	—	4096x14	—	192	22	28SP, 28SO, 28SS	—	—	2	1-16 bit, 2-8 bit, 1-WDT	USART/I ² C/SPI	20	—	✓	—	2	25mA source/sink per I/O
PIC16C65B	7168	4096x14	—	—	192	33	40P, 40JW, 44L, 44PQ, 44PT	—	—	2	1-16 bit, 2-8 bit, 1-WDT	USART/I ² C/SPI	20	✓	✓	—	2	25mA source/sink per I/O, PSP
PIC16CR65	7168	—	4096x14	—	192	33	40P, 44L, 44PQ, 44PT	—	—	2	1-16 bit, 2-8 bit, 1-WDT	USART/I ² C/SPI	20	—	✓	—	2	25mA source/sink per I/O, PSP
PIC16C66	14336	8192x14	—	—	368	22	28SP, 28SO, 28JW	—	—	2	1-16 bit, 2-8 bit, 1-WDT	USART/I ² C/SPI	20	✓	✓	—	2	25mA source/sink per I/O
PIC16C67	14336	8192x14	—	—	368	33	40P, 40JW, 44L, 44PQ, 44PT	—	—	2	1-16 bit, 2-8 bit, 1-WDT	USART/I ² C/SPI	20	✓	✓	—	2	25mA source/sink per I/O, PSP
PIC16C432*	3584	2048x14	—	—	128	12	20SS, 20P, 20JW	—	2	—	1-8 bit, 1-WDT	LIN	20	✓	✓	—	—	25mA source/sink per I/O, LIN XCVR, 18V/40mA
PIC16C433*	3584	2048x14	—	—	128	6	18SO, 18P, 18JW	4	—	—	1-8 bit, 1-WDT	LIN	10	✓	—	—	—	25mA source/sink per I/O, LIN XCVR, 4 MHz internal oscillator, 18V/40mA
PIC16C620A	896	512x14	—	—	96	13	18P, 18SO, 18JW, 20SS	—	2	—	1-8 bit, 1-WDT	—	40	✓	✓	—	—	Prog. VREF, 25mA source/sink per I/O
PIC16CR620A	896	—	512x14	—	96	13	18P, 18SO, 20SS	—	2	—	1-8 bit, 1-WDT	—	20	—	✓	—	—	Prog. VREF, 25mA source/sink per I/O
PIC16C621A	1792	1024x14	—	—	96	13	18P, 18SO, 18JW, 20SS	—	2	—	1-8 bit, 1-WDT	—	40	✓	✓	—	—	Prog. VREF, 25mA source/sink per I/O
PIC16C622A	3584	2048x14	—	—	128	13	18P, 18SO, 18JW, 20SS	—	2	—	1-8 bit, 1-WDT	—	40	✓	✓	—	—	Prog. VREF, 25mA source/sink per I/O
PIC16CE623	896	512x14	—	128	96	13	18P, 18SO, 18JW, 20SS	—	2	—	1-8 bit, 1-WDT	—	30	✓	✓	—	—	Prog. VREF, 25mA source/sink per I/O
PIC16CE624	1792	1024x14	—	128	96	13	18P, 18SO, 18JW, 20SS	—	2	—	1-8 bit, 1-WDT	—	30	✓	✓	—	—	Prog. VREF, 25mA source/sink per I/O
PIC16CE625	3584	2048x14	—	128	128	13	18P, 18SO, 18JW, 20SS	—	2	—	1-8 bit, 1-WDT	—	30	✓	✓	—	—	Prog. VREF, 25mA source/sink per I/O
PIC16C642	7168	4096x14	—	—	176	22	28SP, 28SO, 28JW	—	2	—	1-8 bit, 1-WDT	—	20	✓	✓	—	—	Prog. VREF, 25mA source/sink per I/O
PIC16C662	7168	4096x14	—	—	176	33	40P, 40JW, 44L, 44PQ, 44PT	—	2	—	1-8 bit, 1-WDT	—	20	✓	✓	—	—	Prog. VREF, 25mA source/sink per I/O
PIC16C710	896	512x14	—	—	36	13	18P, 18SO, 18JW, 20SS	4	—	—	1-8 bit, 1-WDT	—	20	✓	✓	—	—	25mA source/sink per I/O
PIC16C711	1792	1024x14	—	—	68	13	18P, 18SO, 18JW, 20SS	4	—	—	1-8 bit, 1-WDT	—	20	✓	✓	—	—	25mA source/sink per I/O
PIC16C712	1792	1024x14	—	—	128	13	18P, 18SO, 18JW, 20SS	4	—	1	1-16 bit, 2-8 bit, 1-WDT	—	20	✓	✓	—	1	25mA source/sink per I/O
PIC16C715	3584	2048x14	—	—	128	13	18P, 18SO, 18JW, 20SS	4	—	—	1-8 bit, 1-WDT	—	20	✓	✓	—	—	25mA source/sink per I/O
PIC16C716	3584	2048x14	—	—	128	13	18P, 18SO, 18JW, 20SS	4	—	1	1-16 bit, 2-8 bit, 1-WDT	—	20	✓	✓	—	1	25mA source/sink per I/O
PIC16C717	3584	2048x14	—	—	256	16	18P, 18SO, 18JW, 20SS	6 (10-bit)	—	1	1-16 bit, 2-8 bit, 1-WDT	M ² C/SPI	20	✓	✓ P	✓	1 ECCP	4MHz internal oscillator, VREF
PIC16C72A	3584	2048x14	—	—	128	22	28SP, 28SO, 28JW, 28SS, 28ML	5	—	1	1-16 bit, 2-8 bit, 1-WDT	I ² C/SPI	20	✓	✓	—	1	25mA source/sink per I/O

PICmicro® MICROCONTROLLER FAMILY PRODUCTS

Product	Program Memory			EEPROM Data Memory Bytes	RAM Bytes	I/O Pins	Packages	Analog		Digital			Max. Speed MHz	ICSP™	BOR/PBOR	PLVD	CCP/ECCP	Other Features
	Bytes	OTP/FLASH Words	ROM Words					8-Bit ADC Channels	Comparators	PWM 10-Bit	Timers/WDT	Serial I/O						
PIC16CXXX: Upwardly Compatible with PIC16C5X/PIC12CXXX, 4–12 Interrupts, 100-500ns Instruction Execution, 35 Instructions, 4/5 Oscillator Selections (continued)																		
PIC16CR72	3584	—	2048x14	—	128	22	28SP, 28SO, 28SS	5	—	1	1-16 bit, 2-8 bit, 1-WDT	I ² C/SPI	20	—	✓	—	1	25mA source/sink per I/O
PIC16C73B	7168	4096x14	—	—	192	22	28SP, 28SO, 28JW, 28SS, 28ML	5	—	2	1-16 bit, 2-8 bit, 1-WDT	USART/I ² C/SPI	20	✓	✓	—	2	25mA source/sink per I/O
PIC16C74B	7168	4096x14	—	—	192	33	40P, 40JW, 44L, 44PQ, 44PT	8	—	2	1-16 bit, 2-8 bit, 1-WDT	USART/I ² C/SPI	20	✓	✓	—	2	25mA source/sink per I/O, PSP
PIC16C76	14336	8192x14	—	—	368	22	28SP, 28SO, 28JW	5	—	2	1-16 bit, 2-8 bit, 1-WDT	USART/I ² C/SPI	20	✓	✓	—	2	25mA source/sink per I/O
PIC16C77	14336	8192x14	—	—	368	33	40P, 40JW, 44L, 44PQ, 44PT	8	—	2	1-16 bit, 2-8 bit, 1-WDT	USART/I ² C/SPI	20	✓	✓	—	2	25mA source/sink per I/O, PSP
PIC16C770	3584	2048x14	—	—	256	16	20P, 20SO, 20JW, 20SS	6 (12-bit)	—	1	1-16 bit, 2-8 bit, 1-WDT	M ² C/SPI	20	✓	✓ P	✓	¹ ECCP	4MHz internal oscillator, VREF
PIC16C771	7168	4096x14	—	—	256	16	20P, 20SO, 20JW, 20SS	6 (12-bit)	—	1	1-16 bit, 2-8 bit, 1-WDT	M ² C/SPI	20	✓	✓ P	✓	¹ ECCP	4MHz internal oscillator, VREF
PIC16C773	7168	4096x14	—	—	256	22	28SP, 28SO, 28SS, 28JW	6 (12-bit)	—	2	1-16 bit, 2-8 bit, 1-WDT	AUSART/M ² C/SPI	20	✓	✓ P	✓	2	25mA source/sink per I/O, VREF
PIC16C774	7168	4096x14	—	—	256	33	40P, 40JW, 44L, 44PQ, 44PT	10 (12-bit)	—	2	1-16 bit, 2-8 bit, 1-WDT	AUSART/M ² C/SPI	20	✓	✓ P	✓	2	25mA source/sink per I/O, VREF, PSP
PIC16C745	14336	8192x14	—	—	256	22	28SP, 28SO, 28JW	5	—	2	1-16 bit, 2-8 bit, 1-WDT	USART, USB	24	✓	✓	—	2	25mA source/sink per I/O, USB 1.1, 64 bytes dual port RAM
PIC16C765	14336	8192x14	—	—	256	33	40P, 40JW, 44L, 44PT	8	—	2	1-16 bit, 2-8 bit, 1-WDT	USART, USB	24	✓	✓	—	2	25mA source/sink per I/O, USB 1.1, 64 bytes dual port RAM, PSP
PIC16C781	1792	1024x14	—	—	128	16	20P, 20SO, 20SS, 20JW	8	2	—	1-16 bit, 1-8 bit, 1-WDT	—	20	✓	✓ P	✓	—	Precision VREF, Op Amp, PSMC, 4MHz internal oscillator, DAC
PIC16C782	3584	2048x14	—	—	128	16	20P, 20SO, 20SS, 20JW	8	2	—	1-16 bit, 1-8 bit, 1-WDT	—	20	✓	✓ P	✓	—	Precision VREF, Op Amp, PSMC, 4MHz internal oscillator, DAC
PIC16C923	7168	4096x14	—	—	176	52	64PT, 68L	—	—	1	1-16 bit, 2-8 bit, 1-WDT	I ² C/SPI	8	✓	—	—	1	25mA source/sink per I/O, LCD module, static, 1/2, 1/3, 1/4 multiplex
PIC16C924	7168	4096x14	—	—	176	52	64PT, 68CL, 68L	5	—	1	1-16 bit, 2-8 bit, 1-WDT	I ² C/SPI	8	✓	—	—	1	25mA source/sink per I/O, LCD module, static, 1/2, 1/3, 1/4 multiplex
PIC16C925	7168	4096x14	—	—	176	52	68CL, 68L, 64PT	5 (10-bit)	—	1	1-16 bit, 2-8 bit, 1-WDT	I ² C/SPI	20	✓	✓	—	1	25mA source/sink per I/O, LCD module static, 1/2, 1/3, 1/4 multiplex, Self-read
PIC16C926	14336	8192x14	—	—	336	52	68CL, 68L, 64PT	5 (10-bit)	—	1	1-16 bit, 2-8 bit, 1-WDT	I ² C/SPI	20	✓	✓	—	1	25mA source/sink per I/O, LCD module static, 1/2, 1/3, 1/4 multiplex, Self-read
PIC16FXXX FLASH MCUs: Upwardly Compatible with PIC16CXXX/PIC16C5X/PIC12CXXX, 4-12 Interrupts, 200ns Instruction Execution, 35 Instructions, 4 Oscillator Selections, 25mA source/sink per I/O																		
PIC16F627	1792 (FLASH)	1024x14 (FLASH)	—	128	224	16	18P, 18SO, 20SS	—	2	1	1-16 bit, 2-8 bit, 1-WDT	AUSART	20	✓	✓	—	1	Prog. VREF, 4MHz internal clock oscillator
PIC16F628	3584 (FLASH)	2048x14 (FLASH)	—	128	224	16	18P, 18SO, 20SS	—	2	1	1-16 bit, 2-8 bit, 1-WDT	AUSART	20	✓	✓	—	1	Prog. VREF, 4MHz internal clock oscillator
PIC16F72#	3584 (FLASH)	2048x14 (FLASH)	—	—	128	22	28SP, 28SO, 28SS, 28ML	5	—	1	1-16 bit, 2-8 bit, 1-WDT	I ² C/SPI	20	✓	✓	—	1	Self-read
PIC16F73	7168 (FLASH)	4096x14 (FLASH)	—	—	192	22	28SP, 28SO, 28SS, 28ML	5	—	2	1-16 bit, 2-8 bit, 1-WDT	USART/I ² C/SPI	20	✓	✓	—	2	Self-read

PICmicro® MICROCONTROLLER FAMILY PRODUCTS

Product	Program Memory			EEPROM Data Memory Bytes	RAM Bytes	I/O Pins	Packages	Analog		Digital			Max. Speed MHz	ICSP™	BOR/PBOR	PLVD	CCP/ECCP	Other Features
	Bytes	OTP/FLASH Words	ROM Words					8-Bit ADC Channels	Comparators	PWM 10-Bit	Timers/WDT	Serial I/O						
PIC16FXXX FLASH MCUs: Upwardly Compatible with PIC16CXXX/PIC16C5X/PIC12CXXX, 4-12 Interrupts, 200ns Instruction Execution, 35 Instructions, 4 Oscillator Selections, 25mA source/sink per I/O (continued)																		
PIC16F74	7168 (FLASH)	4096x14 (FLASH)	—	—	192	33	40P, 44L, 44PT	8	—	2	1-16 bit, 2-8 bit, 1-WDT	USART/I ² C/SPI	20	✓	✓	—	2	PSP, Self-read
PIC16F76	14336 (FLASH)	8192x14 (FLASH)	—	—	368	22	28SP, 28SO, 28SS, 28ML	5	—	2	1-16 bit, 2-8 bit, 1-WDT	USART/I ² C/SPI	20	✓	✓	—	2	Self-read
PIC16F77	14336 (FLASH)	8192x14 (FLASH)	—	—	368	33	40P, 44L, 44PT	8	—	2	1-16 bit, 2-8 bit, 1-WDT	USART/I ² C/SPI	20	✓	✓	—	2	PSP, Self-read
PIC16F84A	1792 (FLASH)	1024x14 (FLASH)	—	64	68	13	18P, 18SO, 20SS	—	—	—	1-8 bit, 1-WDT	—	20	✓	—	—	—	
PIC16F870	3584 (FLASH)	2048x14 (FLASH)	—	64	128	22	28SP, 28SO, 28SS	5 (10-bit)	—	1	1-16 bit, 2-8 bit, 1-WDT	AUSART	20	✓	✓	—	1	Self-Programming, ICD
PIC16F871	3584 (FLASH)	2048x14 (FLASH)	—	64	128	33	40P, 44L, 44PT	8 (10-bit)	—	1	1-16 bit, 2-8 bit, 1-WDT	AUSART	20	✓	✓	—	1	PSP, Self-Programming, ICD
PIC16F872	3584 (FLASH)	2048x14 (FLASH)	—	64	128	22	28SP, 28SO, 28SS	5 (10-bit)	—	1	1-16 bit, 2-8 bit, 1-WDT	Mi ² C/SPI	20	✓	✓	—	1	ICD, Self-Programming
PIC16F873	7168 (FLASH)	4096x14 (FLASH)	—	128	192	22	28SP, 28SO	5 (10-bit)	—	2	1-16 bit, 2-8 bit, 1-WDT	AUSART/Mi ² C/SPI	20	✓	✓	—	2	ICD, Self-Programming
PIC16F873A*#	7168 (FLASH)	4096x14 (FLASH)	—	128	192	22	28SP, 28SO, 28SS, 28ML	5 (10-bit)	2	2	1-16 bit, 2-8 bit, 1-WDT	AUSART/Mi ² C/SPI	20	✓	✓	—	2	ICD, Self-Programming
PIC16F874	7168 (FLASH)	4096x14 (FLASH)	—	128	192	33	40P, 44L, 44PQ, 44PT	8 (10-bit)	—	2	1-16 bit, 2-8 bit, 1-WDT	AUSART/Mi ² C/SPI	20	✓	✓	—	2	PSP, Self-Programming, ICD
PIC16F874A*	7168 (FLASH)	4096x14 (FLASH)	—	128	192	33	40P, 44L, 44PT	8 (10-bit)	2	2	1-16 bit, 2-8 bit, 1-WDT	AUSART/Mi ² C/SPI	20	✓	✓	—	2	PSP, Self-Programming, ICD
PIC16F876	14336 (FLASH)	8192x14 (FLASH)	—	256	368	22	28SP, 28SO	5 (10-bit)	—	2	1-16 bit, 2-8 bit, 1-WDT	AUSART/Mi ² C/SPI	20	✓	✓	—	2	ICD, Self-Programming
PIC16F876A*#	14336 (FLASH)	8192x14 (FLASH)	—	256	368	22	28SP, 28SO, 28SS, 28ML	5 (10-bit)	2	2	1-16 bit, 2-8 bit, 1-WDT	AUSART/Mi ² C/SPI	20	✓	✓	—	2	ICD, Self-Programming
PIC16F877	14336 (FLASH)	8192x14 (FLASH)	—	256	368	33	40P, 44L, 44PQ, 44PT	8 (10-bit)	—	2	1-16 bit, 2-8 bit, 1-WDT	AUSART/Mi ² C/SPI	20	✓	✓	—	2	ICD, PSP, Self-Programming
PIC16F877A*	14336 (FLASH)	8192x14 (FLASH)	—	256	368	33	40P, 44L, 44PT	8 (10-bit)	2	2	1-16 bit, 2-8 bit, 1-WDT	AUSART/Mi ² C/SPI	20	✓	✓	—	2	ICD, PSP, Self-Programming
PIC17CXXX: Upwardly Compatible with PIC16CXX/PIC16C5X/PIC12CXXX, 120ns Instruction Execution Including Multiply, 58 Instructions, 4 Oscillator Selections, Externally expandable to 64Kx16 Program Memory, 25mA source sink per I/O																		
PIC17C42A	4096	2048x16	—	—	232	33	40P, 40JW, 44L, 44PQ, 44PT	—	—	2	2-16 bit, 2-8 bit, 1-WDT	USART	33	—	—	—	—	2 I/O with 60mA sink, 2 Capture, 1 cycle 8x8 multiply, EMA
PIC17CR42	4096	—	2048x16	—	232	33	40P, 44L, 44PQ, 44PT	—	—	2	2-16 bit, 2-8 bit, 1-WDT	USART	33	—	—	—	—	2 I/O with 60mA sink, 2 Capture, 1 cycle 8x8 multiply, EMA
PIC17C43	8192	4096x16	—	—	454	33	40P, 40JW, 44L, 44PQ, 44PT	—	—	2	2-16 bit, 2-8 bit, 1-WDT	USART	33	—	—	—	—	2 I/O with 60mA sink, 2 Capture, 1 cycle 8x8 multiply, EMA
PIC17CR43	8192	—	4096x16	—	454	33	40P, 44L, 44PQ, 44PT	—	—	2	2-16 bit, 2-8 bit, 1-WDT	USART	33	—	—	—	—	2 I/O with 60mA sink, 2 Capture, 1 cycle 8x8 multiply, EMA
PIC17C44	16384	8192x16	—	—	454	33	40P, 40JW, 44L, 44PQ, 44PT	—	—	2	2-16 bit, 2-8 bit, 1-WDT	USART	33	—	—	—	—	2 I/O with 60mA sink, 2 Capture, 1 cycle 8x8 multiply, EMA
PIC17C752	16384	8192x16	—	—	678	50	64PT, 68L	12 (10-bit)	—	3	2-16 bit, 2-8 bit, 1-WDT	USART (2)/Mi ² C/SPI	33	✓	✓	—	—	2 I/O with 60mA sink, 4 Capture, 1 cycle 8x8 multiply, EMA

PICmicro® MICROCONTROLLER FAMILY PRODUCTS

Product	Program Memory			EEPROM Data Memory Bytes	RAM Bytes	I/O Pins	Packages	Analog		Digital			Max. Speed MHz	ICSP™	BOR/PBOR	PLVD	CCP/ECCP	Other Features
	Bytes	OTP/FLASH Words	ROM Words					8-Bit ADC Channels	Comparators	PWM 10-Bit	Timers/WDT	Serial I/O						
PIC17CXXX: Upwardly Compatible with PIC16CXX/PIC16C5X/PIC12CXXX, 120ns Instruction Execution Including Multiply, 58 Instructions, 4 Oscillator Selections, Externally expandable to 64Kx16 Program Memory, 25mA source sink per I/O (continued)																		
PIC17C756A	32768	16384x16	—	—	902	50	64PT, 68L, 68CL	12 (10-bit)	—	3	2-16 bit, 2-8 bit, 1-WDT	USART (2)/Mi ² C/SPI	33	✓	✓	—	—	2 I/O with 60mA sink, 4 Capture, 1 cycle 8x8 multiply, EMA
PIC17C762	16384	8192x16	—	—	678	66	80PT, 84L	16 (10-bit)	—	3	2-16 bit, 2-8 bit, 1-WDT	USART (2)/Mi ² C/SPI	33	✓	✓	—	—	2 I/O with 60mA sink, 4 Capture, 1 cycle 8x8 multiply, EMA
PIC17C766	32768	16384x16	—	—	902	66	80PT, 84L, 84CL	16 (10-bit)	—	3	2-16 bit, 2-8 bit, 1-WDT	USART (2)/Mi ² C/SPI	33	✓	✓	—	—	2 I/O with 60mA sink, 4 Capture, 1 cycle 8x8 multiply, EMA
PIC18CXXX: Upwardly Compatible with PIC17CXXX/PIC16CXX/PIC16C5X/PIC12CXXX, 10 MIPS, 77 Instructions, C-compiler Efficient Instruction Set, Software Stack Capability, Table Read/Write, 4x PLL, Switchable Oscillator Sources, 25mA Source/Sink per I/O																		
PIC18C242	16384	8192x16	—	—	512	23	28SP, 28SO, 28JW	5 (10-bit)	—	2	3-16 bit, 1-8 bit, 1-WDT	AUSART/Mi ² C/SPI	40	✓	✓ P	✓	2	8x8 multiply
PIC18C252	32768	16384x16	—	—	1536	23	28SP, 28SO, 28JW	5 (10-bit)	—	2	3-16 bit, 1-8 bit, 1-WDT	AUSART/Mi ² C/SPI	40	✓	✓ P	✓	2	8x8 multiply
PIC18C442	16384	8192x16	—	—	512	34	40P, 40JW, 44L, 44PT	8 (10-bit)	—	2	3-16 bit, 1-8 bit, 1-WDT	AUSART/Mi ² C/SPI	40	✓	✓ P	✓	2	8x8 multiply, PSP
PIC18C452	32768	16384x16	—	—	1536	34	40P, 40JW, 44L, 44PT	8 (10-bit)	—	2	3-16 bit, 1-8 bit, 1-WDT	AUSART/Mi ² C/SPI	40	✓	✓ P	✓	2	8x8 multiply, PSP
PIC18C601	ROMless	ROMless	—	—	1536	26	64PT, 68L	8 (10-bit)	—	2	3-16 bit, 1-8 bit, 1-WDT	AUSART/Mi ² C/SPI	25	—	—	✓	2	256KB EMA, Bootloader RAM
PIC18C801	ROMless	ROMless	—	—	1536	37	80PT, 84L	12 (10-bit)	—	2	3-16 bit, 1-8 bit, 1-WDT	AUSART/Mi ² C/SPI	25	—	—	✓	2	2MB EMA, Bootloader RAM
PIC18C658	32768	16384x16	—	—	1536	52	64PT, 68L, 68CL	12 (10-bit)	2	2	3-16 bit, 1-8 bit, 1-WDT	AUSART/Mi ² C/SPI/CAN2.0B	40	✓	✓ P	✓	2	Full CAN 2.0B, 3 transmit buffers, 2 receive buffers, 6 acceptance filters, 2 filter masks, PSP
PIC18C858	32768	16384x16	—	—	1536	68	80PT, 84L, 84CL	16 (10-bit)	2	2	3-16 bit, 1-8 bit, 1-WDT	AUSART/Mi ² C/SPI/CAN2.0B	40	✓	✓ P	✓	2	Full CAN 2.0B, 3 transmit buffers, 2 receive buffers, 6 acceptance filters, 2 filter masks, PSP
PIC18FXXX FLASH MCUs: Upwardly Compatible with PIC18CXXX/PIC17CXX/PIC16CXX/PIC16C5X/PIC12CXXX, 77 Instructions, C-compiler Efficient Instruction Set, Software Stack Capability, Table Read/Write, 10 MIPS, 4xPLL, Switchable Oscillator Sources, 25mA Source/Sink per I/O																		
PIC18F242*	16384 (FLASH)	8192x16 (FLASH)	—	256	768	23	28SP, 28SO	5 (10-bit)	—	2	3-16 bit, 1-8 bit, 1-WDT	AUSART/Mi ² C/SPI	40	✓	✓ P	✓	2	Self-Programming, ICD
PIC18F248*	16384 (FLASH)	8192x16 (FLASH)	—	256	768	23	28SP, 28SO	5 (10-bit)	—	1	3-16 bit, 1-8 bit, 1-WDT	AUSART/Mi ² C/SPI/CAN 2.0B	40	✓	✓ P	✓	1	Full CAN 2.0B, 3 transmit buffers, 2 receive buffers, 6 acceptable filters, 2 filter masks, ICD, Self-Programming
PIC18F252*	32768 (FLASH)	16384x16 (FLASH)	—	256	1536	23	28SP, 28SO	5 (10-bit)	—	2	3-16 bit, 1-8 bit, 1-WDT	AUSART/Mi ² C/SPI	40	✓	✓ P	✓	2	Self-Programming, ICD
PIC18F258*	32768 (FLASH)	16384x16 (FLASH)	—	256	1536	23	28SP, 28SO	5 (10-bit)	—	1	3-16 bit, 1-8 bit, 1-WDT	AUSART/Mi ² C/SPI/CAN 2.0B	40	✓	✓ P	✓	1	Full CAN 2.0B, 3 transmit buffers, 2 receive buffers, 6 acceptance filters, 2 filter masks, ICD, Self-Programming
PIC18F442*	16384 (FLASH)	8192x16 (FLASH)	—	256	768	34	40P, 44L, 44PT	8 (10-bit)	—	2	3-16 bit, 1-8 bit, 1-WDT	AUSART/Mi ² C/SPI	40	✓	✓ P	✓	2	Self-Programming, PSP, ICD

PICmicro® MICROCONTROLLER FAMILY PRODUCTS

Product	Program Memory			EEPROM Data Memory Bytes	RAM Bytes	I/O Pins	Packages	Analog		Digital			Max. Speed MHz	ICSP™	BOR/PBOR	PLVD	CCP/ECCP	Other Features
	Bytes	OTP/FLASH Words	ROM Words					8-Bit ADC Channels	Comparators	PWM 10-Bit	Timers/WDT	Serial I/O						
PIC18FXXX FLASH MCUs: Upwardly Compatible with PIC18CXXX/PIC17C7XX/PIC16CXX/PIC16C5X/PIC12CXXX, 77 Instructions, C-compiler Efficient Instruction Set, Software Stack Capability, Table Read/Write, 10 MIPS, 4xPLL, Switchable Oscillator Sources, 25mA Source/Sink per I/O (continued)																		
PIC18F448*	16384 (FLASH)	8192x16 (FLASH)	—	256	768	34	40P, 44L, 44PT	8 (10-bit)	2	1/1	3-16 bit, 1-8 bit, 1-WDT	AUSART/M ² C/SPI/CAN 2.0B	40	✓	✓ P	✓	1/1	Full CAN 2.0B, 3 transmit buffers, 2 receive buffers, 6 acceptance filters, 2 filter masks, ICD, PSP, Self-Programming
PIC18F452*	32768 (FLASH)	16384x16 (FLASH)	—	256	1536	34	40P, 44L, 44PT	8 (10-bit)	—	2	3-16 bit, 1-8 bit, 1-WDT	AUSART/M ² C/SPI	40	✓	✓ P	✓	2	Self-Programming, PSP, ICD
PIC18F458*	32768 (FLASH)	16384x16 (FLASH)	—	256	1536	34	40P, 44L, 44PT	8 (10-bit)	2	1/1	3-16 bit, 1-8 bit, 1-WDT	AUSART/M ² C/SPI/CAN 2.0B	40	✓	✓ P	✓	1/1	Full CAN 2.0B, 3 transmit buffers, 2 receive buffers, 6 acceptance filters, 2 filter masks, PSP, ICD, Self-Programming
PIC18F6620*	65536 (FLASH)	32768x16 (FLASH)	—	1024	3840	52	64PT	12 (10-bit)	2	5	3-16 bit, 2-8 bit, 1-WDT	2 AUSART/M ² C/SPI	40	✓	✓ P	✓	5	PSP, Self-Programming, ICD
PIC18F6720*	131072 (FLASH)	65536x16 (FLASH)	—	1024	3840	52	64PT	12 (10-bit)	2	5	3-16 bit, 2-8 bit, 1-WDT	2 AUSART/M ² C/SPI	40	✓	✓ P	✓	5	PSP, Self-Programming, ICD
PIC18F8620*	65536 (FLASH)	32768x16 (FLASH)	—	1024	3840	68	80PT	16 (10-bit)	2	5	3-16 bit, 2-8 bit, 1-WDT	2 AUSART/M ² C/SPI	40	✓	✓ P	✓	5	PSP, Self-Programming, EMA, ICD
PIC18F8720*	131072 (FLASH)	65536x16 (FLASH)	—	1024	3840	68	80PT	16 (10-bit)	2	5	3-16 bit, 2-8 bit, 1-WDT	2 AUSART/M ² C/SPI	40	✓	✓ P	✓	5	PSP, Self-Programming, EMA, ICD

Abbreviations:

ADC = Analog-to-Digital Converter
AUSART = Addressable USART
BOR = Brown-out Detection/Reset
CAP = Capture
CCP = Capture/Compare/PWM
DAC = Digital-to-Analog Converter
3φ = 3 Phase PWMs
E2 = EEPROM (Reprogrammable)

ECCP = Enhanced Capture/Compare/PWM
EMA = External Memory Addressing
I²C = Inter-integrated Circuit Bus
ICSP = In-Circuit Serial Programming
ICD = In-Circuit Debug
LVD = Low Voltage Detection
LIN XCVR = Local Interconnection Network Transceiver

M²C/SPI = Master I²C/SPI
PBOR = Programmable Brown-Out Detection/Reset
PLVD = Programmable Low-Voltage Detection
PSP = Parallel Slave Port
PWM = Pulse Width Modulator
PSMC = Programmable Switch Mode Controller
SLAC = Slope A/D Converter, up to 16 bits

SMB = System Management Bus
SPI = Serial Peripheral Interface
USART = Universal Synchronous/Asynchronous Receiver/Transmitter
USB = Universal Serial Bus
VREF = Voltage Reference
WDT = Watchdog Timer
✓ P = Programmable

*Contact Microchip Technology for availability date.
#Contact Microchip Technology for MLF package.

MATURE MICROCHIP PRODUCT LINE

PICmicro® MICROCONTROLLER FAMILY PRODUCTS (Newer versions of these products are available in the "Current" section of this Product Line Card)

Product	Program Memory			EEPROM Data Memory Bytes	RAM Bytes	I/O Pins	Packages	Analog		Digital			Max. Speed MHz	ICSP™	BOR/PBOR	PLVD	CCP/ECCP	Other Features
	Bytes	OTP/FLASH Words	ROM Words					8-Bit ADC Channels	Comparators	PWM 10-Bit	Timers/WDT	Serial I/O						
PIC12C508	768	512x12	—	—	25	6	8P, 8SM, 8JW	—	—	—	1-8 bit, 1-WDT	—	4	✓	—	—	—	25mA source/sink per I/O
PIC12C509	1536	1024x12	—	—	41	6	8P, 8SM, 8JW	—	—	—	1-8 bit, 1-WDT	—	4	✓	—	—	—	25mA source/sink per I/O
PIC16C54	768	512x12	—	—	25	12	18P, 18JW, 18SO, 20SS	—	—	—	1-8 bit, 1-WDT	—	20	—	—	—	—	20mA source and 25mA sink per I/O
PIC16CR54A	768	—	512x12	—	25	12	18P, 18SO, 20SS	—	—	—	1-8 bit, 1-WDT	—	20	—	—	—	—	20mA source and 25mA sink per I/O
PIC16C54A	768	512x12	—	—	25	12	18P, 18JW, 18SO, 20SS	—	—	—	1-8 bit, 1-WDT	—	20	—	—	—	—	20mA source and 25mA sink per I/O
PIC16C55	768	512x12	—	—	24	20	28P, 28JW, 28SP, 28SO, 28SS	—	—	—	1-8 bit, 1-WDT	—	20	—	—	—	—	20mA source and 25mA sink per I/O
PIC16C56	1536	1024x12	—	—	25	12	18P, 18JW, 18SO, 20SS	—	—	—	1-8 bit, 1-WDT	—	20	—	—	—	—	20mA source and 25mA sink per I/O
PIC16C57	3072	2048x12	—	—	72	20	28P, 28JW, 28SP, 28SO, 28SS	—	—	—	1-8 bit, 1-WDT	—	20	—	—	—	—	20mA source and 25mA sink per I/O
PIC16C62A	3584	2048x14	—	—	128	22	28SP, 28SO, 28SS, 28JW	—	—	1	1-16 bit, 2-8 bit, 1-WDT	I ² C/SPI	20	✓	✓	—	1	25mA source/sink per I/O
PIC16C63	7168	4096x14	—	—	192	22	28SP, 28SO, 28JW	—	—	2	1-16 bit, 2-8 bit, 1-WDT	USART/I ² C/SPI	20	✓	✓	—	2	25mA source/sink per I/O
PIC16C64A	3584	2048x14	—	—	128	33	40P, 40JW, 44L, 44PQ, 44PT	—	—	1	1-16 bit, 2-8 bit, 1-WDT	I ² C/SPI	20	✓	✓	—	1	25mA source/sink per I/O, PSP
PIC16C65A	7168	4096x14	—	—	192	33	40P, 40JW, 44L, 44PQ, 44PT	—	—	2	1-16 bit, 2-8 bit, 1-WDT	USART/I ² C/SPI	20	✓	✓	—	2	25mA source/sink per I/O, PSP
PIC16C620	896	512x14	—	—	80	13	18P, 18SO, 18JW, 20SS	—	2	—	1-8 bit, 1-WDT	—	20	✓	✓	—	—	Prog. VREF, 25mA source/sink per I/O
PIC16C621	1792	1024x14	—	—	80	13	18P, 18SO, 18JW, 20SS	—	2	—	1-8 bit, 1-WDT	—	20	✓	✓	—	—	Prog. VREF, 25mA source/sink per I/O
PIC16C622	3584	2048x14	—	—	128	13	18P, 18SO, 18JW, 20SS	—	2	—	1-8 bit, 1-WDT	—	20	✓	✓	—	—	Prog. VREF, 25mA source/sink per I/O
PIC16C71	1792	1024x14	—	—	36	13	18P, 18SO, 18JW	4	—	—	1-8 bit, 1-WDT	—	20	✓	—	—	—	25mA source/sink per I/O
PIC16C72	3584	2048x14	—	—	128	22	28SP, 28SO, 28JW, 28SS	5	—	1	1-16 bit, 2-8 bit, 1-WDT	I ² C/SPI	20	✓	✓	—	1	25mA source/sink per I/O
PIC16C73A	7168	4096x14	—	—	192	22	28SP, 28SO, 28JW	5	—	2	1-16 bit, 2-8 bit, 1-WDT	USART/I ² C/SPI	20	✓	✓	—	2	25mA source/sink per I/O
PIC16C74A	7168	4096x14	—	—	192	33	40P, 40JW, 44L, 44PQ, 44PT	8	—	2	1-16 bit, 2-8 bit, 1-WDT	USART/I ² C/SPI	20	✓	✓	—	2	25mA source/sink per I/O, PSP
PIC16F83	896 (FLASH)	512x14 (FLASH)	—	64	36	13	18P, 18SO	—	—	—	1-8 bit, 1-WDT	—	10	✓	—	—	—	20mA source and 25mA sink per I/O
PIC16CR83	896	—	512x14	64	36	13	18P, 18SO	—	—	—	1-8 bit, 1-WDT	—	10	—	—	—	—	20mA source and 25mA sink per I/O
PIC16F84	1792 (FLASH)	1024x14 (FLASH)	—	64	68	13	18P, 18SO	—	—	—	1-8 bit, 1-WDT	—	10	✓	—	—	—	20mA source and 25mA sink per I/O
PIC16CR84	1792	—	1024x14	64	68	13	18P, 18SO	—	—	—	1-8 bit, 1-WDT	—	10	—	—	—	—	20mA source and 25mA sink per I/O

Radio Frequency Products

RADIO FREQUENCY PRODUCTS

ACTIVE

rfPIC™ Microcontrollers with UHF RF Transmitter

Product	Program Memory		EEPROM Data Memory Bytes	RAM Bytes	I/O Pins	Packages	Analog Peripherals	Digital Peripherals	Max Speed MHz	ICSP	RF Specifications			Other Features	
	Bytes	OTP/FLASH Words									Modulation	Data Rate kbps	Output Power dBm		Operating Voltage
rfPIC12C509AG	1536	1024 x 12	—	41	6	18JW, 18SO	—	1-8 bit Timer, WDT	4	✓	ASK	40	2dBm	2.5 - 5.5	25mA source/sink per I/O
rfPIC12C509AF	1536	1024 x 12	—	41	6	20JW, 20SS	—	1-8 bit Timer, WDT	4	✓	FSK, ASK	40	2dBm	2.5 - 5.5	25mA source/sink per I/O

rfHCS KEELoq® Encoders with UHF RF Transmitter

Product	Transmission Code Length Bits	Code Hopping Bits	Programmable Encryption Key Bits	Packages	Protocols	Function Codes	Tunable OSC	CRC	RF Specifications			Other Features
									Modulation	Output Power dBm	Operating Voltage	
rfHCS362G*	69	32	2 x 64	18SO	PWM, Manchester	4 x 15	✓	✓	ASK	2dBm	2.2 - 5.5	Queue Count, Timer bits
rfHCS362F*	69	32	2 x 64	20SS	PWM, Manchester	4 x 15	✓	✓	FSK, ASK	2dBm	2.2 - 5.5	Queue Count, Timer bits

Abbreviations:

ASK = Amplitude Shift Key

CRC = Cyclic Redundancy Check

FSK = Frequency Shift Key

ICSP = In-Circuit Serial Programming

OTP = One-time Programmable

PWM = Pulse Width Modulation

WDT = Watchdog Timer

* Contact Microchip Technology for availability date.

See also KEELoq® Secure Data Products below.

PASSIVE

microID® RFID Tagging Devices

Product	Carrier Frequency	Programming	Anticollison	Memory Type	Memory Size	Protocols	Packages	Other
MCRF200	100-150kHz	Contactless	No	OTP	96/128 bits	PSK, FSK, ASK, biphase, Manchester, NRZ	W, WF, S, WB, WFB, SB, 1C, 3C, P, SN	—
MCRF202	100-150kHz	Contact	Yes	OTP	96/128 bits	FSK, ASK, biphase, Manchester, NRZ	W, WF, S, WB, WFB, SB, P, SN	Sensor input
MCRF250	100-150kHz	Contactless	Yes	OTP	96/128 bits	PSK, FSK, ASK, biphase, Manchester, NRZ	W, WF, S, WB, WFB, SB, 1C, 3C, P, SN	—
MCRF355	13.56MHz	Contact	Yes	R/W	154 bits	ASK Manchester, up to 24MHz	W, WF, S, WB, WFB, SB, P, SN, 6C	—
MCRF360	13.56MHz	Contact	Yes	R/W	154 bits	ASK Manchester, up to 24MHz	W, WF, S, WB, WFB, SB, P, SN	100pF res cap
MCRF450	13.56MHz	Contactless	Yes	R/W	1K bits	PPM, ASK Manchester	W, WF, S, WB, WFB, SB, P, SN, 6C	32-bit unique ID user lock control by block
MCRF452	13.56MHz	Contactless	Yes	R/W	1K bits	PPM, ASK Manchester	W, WF, S, WB, WFB, SB, P, SN, 6C	Dual res cap

SECURE DATA PRODUCTS

KEELOQ® Encoder Devices

Product	Transmission Code Length Bits	Code Hopping Bits	Programmable Encryption Key Bits	Seed Length	Operating Voltage	Tunable OSC	Function Codes	CRC	Protocols	Other Features	Packages
HCS101	66	—	—	—	3.5V to 13.0V	Yes	7	No	PWM	Fixed code support for non-secure applications, up to 28-bit serial numbers	8P, 8SN
HCS200	66	32	64	32	3.5V to 13.0V	No	7	No	PWM	Entry Level, Fixed code support, Battery Low indicator	8P, 8SN
HCS201	66	32	64	32	3.5V to 13.0V	Yes	7	No	PWM	Entry Level, Fixed code support, Battery Low indicator, step-up voltage operation	8P, 8SN
HCS300	66	32	64	32	2.0V to 6.3V	No	15	No	PWM	LED Drive, Overflow bits, Time-out, Battery low indicator	8P, 8SN
HCS301	66	32	64	32	3.5V to 13.0V	No	15	No	PWM	LED Drive, Overflow bits, Time-out, Battery low indicator	8P, 8SN
HCS320	66	32	64	32	3.5V to 13.0V	No	16	No	PWM	Shift Operation, LED Drive, Overflow bits, Time-out, Battery low indicator	8P, 8SN
HCS360	67	32	64	48	2.0V to 6.3V	No	15	Yes	IR Mode, PWM and Manchester	2 independent counters	8P, 8SN
HCS361	67	32	64	48	2.0V to 6.3V	No	15	Yes	IR Mode, PWM and VPWM	2 independent counters	8P, 8SN
HCS362	69	32	2 x 64	60	2.0V to 6.3V	Yes	4 x 15	Yes	PWM and Manchester	Queue counter, PLL interface, Timer bits, Programmable time-out	8P, 8SN, 8ST
HCS365	69	32	2 x 64	2 x 60	2.0V to 5.5V	Factory	4 X 15	Yes	PWM, VPWM PPM and Manchester	Dual Encoder Operation, 4 inputs, Queue counter	8P, 8SM
HCS370	69	32	2 x 64	2 x 60	2.0V to 5.5V	Factory	4 X 15	Yes	PWM, VPWM PPM and Manchester	Stepup voltage regulation, Dual Encoder Operation, 6 inputs, Queue counter	14P, 14SL

KEELOQ® Transcoder Devices

HCS410	69	32	2 x 64	60	2.0V to 6.6V	Yes	4 x 7	Yes	PWM and Manchester	Self-powered transponder and encoder, bi-directional authentication, user EEPROM, Queue counter	8P, 8SN, 8ST
HCS412	69	32	2 x 64	60	2.0V to 6.6V	Yes	4 x 7	Yes	PWM and Manchester	Passive Entry Encoder and Transponder, bi-directional authentication, user EEPROM, Queue counter	8P, 8SN, 8ST
HCS473*	69	32	2 x 64	60	2.0V to 5.5V	Factory	4 x 15	Yes	PWM and Manchester	3 Axis Passive Entry, bi-directional authentication, user EEPROM	14P, 14SL

KEELOQ® Decoder Devices

Product	Reception Length Bits	Encoders Supported**	Transmitters Supported	Operating Voltage	Functions	Other Features	Packages
HCS500	66	HCS200, HCS201, HCS300, HCS301, HCS320, HCS360, HCS361, HCS362, HCS365, HCS370, HCS410, HCS412, HCS473	Up to 7	3.0V to 5.5V	S0, 15 Serial Functions	Full-featured decoder with serial interface to microcontrollers	8P, 8SM
HCS512	66	HCS200, HCS201, HCS300, HCS301, HCS320, HCS360, HCS361, HCS362, HCS365, HCS370, HCS410, HCS412, HCS473	Up to 4	4.0V to 6.0V	S0, S1, S2, S3; VLOW, 15 Serial Functions	Single-chip decoder with secure learning	18P, 18SO
HCS515	66	HCS200, HCS201, HCS300, HCS301, HCS320, HCS360, HCS361, HCS362, HCS365, HCS370, HCS410, HCS412, HCS473	Up to 7	4.5V to 5.5V	S0, S1, 15 Serial Functions	Full-featured decoder with serial and parallel interface. On-chip 1K transmitter and 1K user EEPROM.	14P, 14SL

* Contact Microchip Technology for availability date.

**PWM only.

ANALOG/INTERFACE PRODUCTS

THERMAL MANAGEMENT PRODUCTS - Temperature Sensors

Part #	Typical Accuracy (°C)	Maximum Accuracy @ 25°C (°C)	Maximum Temperature Range (°C)	Vcc Range (V)	Maximum Supply Current (µA)	Features	Packages
Logic Output Temperature Sensors							
TC6501	±0.5	±3	-55 to +125	+2.7 to +5.5	40	Cross to MAX6501, Open drain	5-Pin SOT-23A
TC6502	±0.5	±3	-55 to +125	+2.7 to +5.5	40	Cross to MAX6502, Push-pull	5-Pin SOT-23A
TC6503	±0.5	±3	-55 to +125	+2.7 to +5.5	40	Cross to MAX6503, Open drain	5-Pin SOT-23A
TC6504	±0.5	±3	-55 to +125	+2.7 to +5.5	40	Cross to MAX6504, Push-pull	5-Pin SOT-23A
TC07	±1	±3	-40 to +125	+2.7 to +5.5	300	Dual output, programmable hysteresis	8-Pin MSOP, 8-Pin SOIC
TC620	±1	±3	-40 to +125	+4.5 to +18	400	Dual trip points	8-Pin PDIP, 8-Pin SOIC
TC621	Note 1	Note 1	-40 to +85	+4.5 to +18	400	Uses external temperature sensor	8-Pin PDIP, 8-Pin SOIC
TC622	±1	±5	-40 to +125	+4.5 to +18	600	Dual output, TO-220 for heat sink mounting	8-Pin PDIP, 8-Pin SOIC, 5-Pin TO-220
TC623	±1	±3	-40 to +125	+2.7 to +4.5	250	Dual trip points, programmable hysteresis output	8-Pin PDIP, 8-Pin SOIC
TC624	±1	±5	-40 to +125	+2.7 to +4.5	300	Dual output	8-Pin PDIP, 8-Pin SOIC
Voltage Output Temperature Sensors							
TC1046	±0.5	±2	-40 to +125	+2.7 to +4.4	60	High precision temperature-to-voltage converter, 6.25mV/°C	3-Pin SOT-23B
TC1047	±0.5	±2	-40 to +125	+2.7 to +4.4	60	High precision temperature-to-voltage converter, 10mV/°C	3-Pin SOT-23B
TC1047A	±0.5	±2	-40 to +125	+2.5 to +5.5	60	High precision temperature-to-voltage converter, 10mV/°C	3-Pin SOT-23B

- NOTES** 1. These devices use an external temperature sensor. Accuracy of the total solution is a function of the accuracy of the external sensor.
 2. TCN75 idle current is 250µA. This device also has a software shutdown mode that reduces supply current to <1µA.

THERMAL MANAGEMENT PRODUCTS - Temperature Sensors

Part #	Typical Accuracy (°C)	Maximum Accuracy @ 25°C (°C)	Maximum Temperature Range (°C)	Vcc Range (V)	Maximum Supply Current (µA)	Features	Packages
Serial Output Temperature Sensors							
TC74	±0.5	±2	-40 to +125	+2.7 to +5.5	350	Serial digital thermal sensor	5-Pin SOT-23A, 5-Pin TO-220
TCN75	±0.5	±2	-55 to +125	+2.7 to +5.5	1,000 ²	Two wire multidrop sensor with interrupt	8-Pin MSOP, 8-Pin SOIC

- NOTES** 1. These devices use an external temperature sensor. Accuracy of the total solution is a function of the accuracy of the external sensor.
 2. TCN75 idle current is 250µA. This device also has a software shutdown mode that reduces supply current to <1µA.

THERMAL MANAGEMENT PRODUCTS - Brushless DC Fan Controllers and Fan Fault Detectors

Part #	Description	Typical Accuracy (°C)	Maximum Accuracy @ 25°C (°C)	Maximum Temperature Range (°C)	Vcc Range (V)	Max Supply Current (µA)	Features	Packages
TC642	Fan Manager	Note 1	Note 1	0 to +85	+3.0 to +5.5	1,000	FanSense™ Fan Monitor, Minimum fan speed control	8-Pin PDIP, 8-Pin SOIC, 8-Pin MSOP
TC646	Fan Manager	Note 1	Note 1	0 to +85	+3.0 to +5.5	1,000	FanSense™ Fan Monitor, Auto-shutdown	8-Pin PDIP, 8-Pin SOIC, 8-Pin MSOP
TC647	Fan Manager	Note 1	Note 1	0 to +85	+3.0 to +5.5	1,000	FanSense™ Fan Monitor, Minimum fan speed control	8-Pin PDIP, 8-Pin SOIC, 8-Pin MSOP
TC648	Fan Manager	Note 1	Note 1	0 to +85	+3.0 to +5.5	1,000	Over temperature alert, Auto-shutdown	8-Pin PDIP, 8-Pin SOIC, 8-Pin MSOP
TC649	Fan Manager	Note 1	Note 1	0 to +85	+3.0 to +5.5	1,000	FanSense™ Fan Monitor, Auto-shutdown	8-Pin PDIP, 8-Pin SOIC, 8-Pin MSOP
TC650	Fan Manager	±1	±3	-40 to +125	+2.8 to +5.5	90	Over temperature alert	8-Pin MSOP
TC651	Fan Manager	±1	±3	-40 to +125	+2.8 to +5.5	90	Over temperature alert, Auto-shutdown	8-Pin MSOP
TC652	Fan Manager	±1	±3	-40 to +125	+2.8 to +5.5	90	FanSense™ Fan Monitor, Over temperature alert	8-Pin MSOP
TC653	Fan Manager	±1	±3	-40 to +125	+2.8 to +5.5	90	FanSense™ Fan Monitor, Over temperature alert, Auto-shutdown	8-Pin MSOP
TC670	Predictive Fan Fault Detector	N/A	N/A	-40 to +85	+3.0 to +5.5	150	FanSense™ Fan Monitor, Programmable Threshold	6-Pin SOT-23

- NOTES** 1. These devices use an external temperature sensor. Accuracy of the total solution is a function of the accuracy of the external sensor.

POWER MANAGEMENT - Voltage References

Part #	Vcc Range (V)	Output Voltage (V)	Max. Load Current (mA)	Initial Accuracy (max %)	Temperature Coefficient (ppm/°C)	Max. Supply Current (µA @ 25°C)	Packages
MCP1525	2.7 to 5.5	2.5	±2	±1	50	100	3-Pin TO-92, 3-Pin SOT-23B
MCP1541	4.3 to 5.5	4.096	±2	±1	50	100	3-Pin TO-92, 3-Pin SOT-23B

POWER MANAGEMENT - Linear Regulators

Part #	Max Input Voltage (V)	Output Voltage (V)	Output Current (mA)	Typical Active Current (µA)	Typical Dropout Voltage @ Max IOUT (mV)	Typical Output Voltage Accuracy (%)	Features	Packages
50mA to 250mA Low Dropout Linear Regulators								
TC2014	6.0	1.8, 2.7, 2.8, 3.0, 3.3	50	55	45	±0.4	Shutdown, Reference bypass input	5-Pin SOT-23A
TC1014	6.0	1.8, 2.5, 2.7, 2.8, 2.85, 3.0, 3.3, 3.6, 4.0, 5.0	50	50	85	±0.5	Shutdown, Reference bypass input	5-Pin SOT-23A
TC2054	6.0	1.8, 2.7, 2.8, 3.0, 3.3	50	55	45	±0.4	Shutdown, Error output	5-Pin SOT-23A
TC1054	6.0	1.8, 2.5, 2.7, 2.8, 2.85, 3.0, 3.3, 3.6, 4.0, 5.0	50	50	85	±0.5	Shutdown, Error output	5-Pin SOT-23A
TC1070	6.0	1.23 → VIN	50	50	85	—	Shutdown, Adjustable	5-Pin SOT-23A
TC1072	6.0	2.5, 2.7, 2.8, 2.85, 3.0, 3.3, 3.6, 4.0, 5.0	50	50	85	±0.5	Shutdown, Reference bypass input, Error output	6-Pin SOT-23A
TC1223	6.0	2.5, 2.7, 2.8, 3.0, 3.3, 3.6, 4.0, 5.0	50	50	85	±0.5	Shutdown	5-Pin SOT-23A
TC1016	6.0	1.8, 2.7, 2.8, 3.0	80	50	150	±0.5	Shutdown	5-Pin SC-70
TC2015	6.0	1.8, 2.7, 2.8, 3.0, 3.3	100	55	90	±0.4	Shutdown, Reference bypass input	5-Pin SOT-23A
TC1015	6.0	1.8, 2.5, 2.7, 2.8, 2.85, 3.0, 3.3, 3.6, 4.0, 5.0	100	50	180	±0.5	Shutdown, Reference bypass input	5-Pin SOT-23A
TC2055	6.0	1.8, 2.7, 2.8, 3.0, 3.3	100	55	90	±0.4	Shutdown, Error output	5-Pin SOT-23A
TC1055	6.0	1.8, 2.5, 2.7, 2.8, 2.85, 3.0, 3.3, 3.6, 4.0, 5.0	100	50	180	±0.5	Shutdown, Error output	5-Pin SOT-23A
TC1071	6.0	1.23 → VIN	100	50	180	—	Shutdown, Adjustable	5-Pin SOT-23A
TC1073	6.0	2.5, 2.7, 2.8, 2.85, 3.0, 3.3, 3.6, 4.0, 5.0	100	50	180	±0.5	Shutdown, Reference bypass input, Error output	6-Pin SOT-23A

- NOTES**
1. Depending on external transistor configuration.
 2. Each channel (for Dual and Quad LDOs)
 3. LDOs with shutdown except TC56 and TC57 have typical shutdown currents of 0.05µA.

POWER MANAGEMENT - Linear Regulators

Part #	Max Input Voltage (V)	Output Voltage (V)	Output Current (mA)	Typical Active Current (μ A)	Typical Dropout Voltage @ Max Iout (mV)	Typical Output Voltage Accuracy (%)	Features	Packages
50mA to 250mA Low Dropout Linear Regulators (continued)								
TC1224	6.0	2.5, 2.7, 2.8, 3.0, 3.3, 3.6, 4.0, 5.0	100	50	180	± 0.5	Shutdown	5-Pin SOT-23A
TC1188	6.0	1.8, 2.8, 2.84, 3.15	120	50	130	± 0.5	Shutdown	5-Pin SOT-23A
TC1189	6.0	1.8, 2.8, 2.84, 3.15	120	50	130	± 0.5	Shutdown	5-Pin SOT-23A
TC2185	6.0	1.8, 2.7, 2.8, 3.0, 3.3	150	55	140	± 0.4	Shutdown, Reference bypass input	5-Pin SOT-23A
TC1185	6.0	1.8, 2.5, 2.7, 2.8, 2.85, 3.0, 3.3, 3.6, 4.0, 5.0	150	50	270	± 0.5	Shutdown, Reference bypass input	5-Pin SOT-23A
TC2186	6.0	1.8, 2.7, 2.8, 3.0, 3.3	150	55	140	± 0.4	Shutdown, Error output	5-Pin SOT-23A
TC1186	6.0	1.8, 2.5, 2.7, 2.8, 2.85, 3.0, 3.3, 3.6, 4.0, 5.0	150	50	270	± 0.5	Shutdown, Error output	5-Pin SOT-23A
TC1187	6.0	1.23 \rightarrow VIN	150	50	270	—	Shutdown, Adjustable	5-Pin SOT-23A
TC56	10	2.5, 3.0, 3.3	180	11	330	± 0.5	Shutdown	5-Pin SOT23A
TC55	10	1.2V to 6.0V in 0.1V increments	250	1.1	380	± 0.5		3-Pin SOT-23A, 3-Pin SOT-89, 3-Pin TO-92
300mA Low Dropout Linear Regulators								
TC1107	6.0	2.5, 2.7, 2.8, 3.0, 3.3, 5.0	300	50	240	± 0.5	Shutdown, Reference bypass input	8-Pin MSOP, 8-Pin SOIC
TC1108	6.0	2.5, 2.7, 2.8, 3.0, 3.3, 5.0	300	50	240	± 0.5		3-Pin SOT-223
TC1173	6.0	2.5, 2.7, 2.8, 3.0, 3.3, 5.0	300	50	240	± 0.5	Shutdown, Reference bypass input, Error output	8-Pin MSOP, 8-Pin SOIC
TC1174	6.0	1.23 \rightarrow VIN	300	50	240	—	Shutdown, Reference bypass input, Adjustable	8-Pin MSOP, 8-Pin SOIC
TC1269	6.0	2.5, 2.8, 3.0, 3.3, 5.0	300	50	240	± 0.5	Shutdown, Reference bypass input	8-Pin MSOP
500mA to 800mA Low Dropout Linear Regulators								
TC1262	6.0	2.5, 2.8, 3.0, 3.3, 5.0	500	80	350	± 0.5		3-Pin TO-220, 3-Pin DDPACK, 3-Pin SOT-223
TC1263	6.0	2.5, 2.8, 3.0, 3.3, 5.0	500	80	350	± 0.5	Shutdown, Reference bypass input, Error output	8-Pin SOIC, 5-Pin TO-220, 5-Pin DDPACK

- NOTES**
- Depending on external transistor configuration.
 - Each channel (for Dual and Quad LDOs)
 - LDOs with shutdown except TC56 and TC57 have typical shutdown currents of 0.05 μ A.

POWER MANAGEMENT - Linear Regulators								
Part #	Max Input Voltage (V)	Output Voltage (V)	Output Current (mA)	Typical Active Current (μ A)	Typical Dropout Voltage @ Max IOUT (mV)	Typical Output Voltage Accuracy (%)	Features	Packages
500mA to 800mA Low Dropout Linear Regulators (continued)								
TC1268	6.0	2.5	500	80	350	± 0.5	Shutdown, Reference bypass input, Error output	8-Pin SOIC
TC1264	6.0	1.8, 2.5, 3.0, 3.3	800	80	450	± 0.5		3-Pin TO-220, 3-Pin DDPAK, 3-Pin SOT-223
TC1265	6.0	1.8, 2.5, 3.0, 3.3	800	80	450	± 0.5	Shutdown, Reference bypass input, Error output	8-Pin SOIC, 5-Pin TO-220, 5-Pin DDPAK
TC2117	6.0	1.8, 2.5, 3.0, 3.3	800	80	600	± 0.5		3-Pin SOT-223, 3-Pin DDPAK
Application Specific Low Dropout Linear Regulators								
TC1266	6.0	3.3	200	230	200	± 1.0	PCI compliant	8-Pin SOIC, 8-Pin MSOP
TC1267	6.0	3.3	400	230	300	± 1.0	PCI compliant	5-Pin DDPAK
TC57	8	2.5, 3.0, 3.3	4,000 ⁽¹⁾	50	100 ⁽¹⁾	± 2.0	Shutdown, external transistor	5-Pin SOT-23A
TC59	-10	-3.0, -5.0	100	3	380	± 0.5	Negative LDO	3-Pin SOT-23A
Power Management Combination Products								
TC1300	6.0	2.5, 2.7, 2.8, 2.85, 3.0, 3.3	300	80	210	± 0.5	Shutdown, Reference bypass input, LDO plus RESET output	8-Pin MSOP
TC1305	6.0	2.5, 2.8, 3.0	150 ⁽²⁾	120	240	± 0.5	Dual LDO plus RESET output, reference bypass input, Shutdown, Select Mode™ selectable output voltages	10-Pin MSOP
TC1306	6.0	1.8, 2.8, 3.0	150 ⁽²⁾	120	240	± 0.5	Dual LDO plus RESET output, Shutdown, Select Mode™ selectable output voltages	8-Pin MSOP
TC1307	6.0	1.8, 2.5, 2.8, 3.0	150 ⁽²⁾	220	200	± 0.5	Quad LDO plus RESET output, shutdown, Select Mode™ selectable output voltage	16-Pin QSOP

- NOTES**
1. Depending on external transistor configuration.
 2. Each channel (for Dual and Quad LDOs)
 3. LDOs with shutdown except TC56 and TC57 have typical shutdown currents of 0.05 μ A.

POWER MANAGEMENT - Switching Regulators

Part #	Description	Input Voltage Range (V)	Output Voltage (V)	Control Scheme (kHz)	Switching Frequency (kHz)	Typical Active Supply (μ A)	Output Current (mA)	Features	Packages
TC125	Step-up DC/DC Regulator	0.9 to 10	3.0, 3.3, 5.0	PFM	100	20	80	Low-power shutdown mode	5-Pin SOT-23A
TC126	Step-up DC/DC Regulator	0.9 to 10	3.0, 3.3, 5.0	PFM	100	20	80	Feedback voltage sensing	5-Pin SOT-23A
TC115	Step-up DC/DC Regulator	0.9 to 10	3.0, 3.3, 5.0	PFM/PWM	100	80	140	Feedback voltage sensing, Low-power shutdown mode	5-Pin SOT-89
TC110	Step-up DC/DC Controller	2.0 to 10	3.0, 3.3, 5.0	PFM/PWM	100/300	50/120	300	Soft-start, Low-power shutdown mode	5-Pin SOT-23A
TC105	Step-down DC/DC Controller	2.2 to 10	3.0, 3.3, 5.0	PFM/PWM	300	57	1,000	Low-power shutdown mode	5-Pin SOT-23A
TC120	Step-down Regulator/Controller Combination	1.8 to 10	3.0, 3.3, 5.0	PFM/PWM	300	52	2,000	Soft-start, Low-power shutdown mode	8-Pin SOP

POWER MANAGEMENT - Charge Pump DC-to-DC Converters

Part #	Input Voltage Range (V)	Output Voltage (V)	Maximum Input Current ¹ (μ A)	Typical Active Output Current (mA)	Features	Packages
Inverting or Doubling Charge Pumps						
TC1044S	1.5 to 12	$V_{OUT} = -V_{IN}$ or $V_{OUT} = 2V_{IN}$	160	20	85 kHz oscillator boost mode	8-Pin PDIP, 8-Pin SOIC
TC7660	1.5 to 10	$V_{OUT} = -V_{IN}$ or $V_{OUT} = 2V_{IN}$	180	20	10 kHz oscillator	8-Pin PDIP, 8-Pin SOIC
TC7660H	1.5 to 10	$V_{OUT} = -V_{IN}$ or $V_{OUT} = 2V_{IN}$	1,000	20	120 kHz oscillator	8-Pin PDIP, 8-Pin SOIC
TC7660S	1.5 to 12	$V_{OUT} = -V_{IN}$ or $V_{OUT} = 2V_{IN}$	160	20	45 kHz oscillator, boost mode	8-Pin PDIP, 8-Pin SOIC
TC7662B	1.5 to 15	$V_{OUT} = -V_{IN}$ or $V_{OUT} = 2V_{IN}$	180	20	35 kHz oscillator, boost mode	8-Pin PDIP, 8-Pin SOIC
TC1219	1.5 to 5.5	$V_{OUT} = -V_{IN}$ or $V_{OUT} = 2V_{IN}$	115	25	12 kHz oscillator, Low power shutdown mode	6-Pin SOT-23A
TC1220	1.5 to 5.5	$V_{OUT} = -V_{IN}$ or $V_{OUT} = 2V_{IN}$	325	25	35 kHz oscillator, Low power shutdown mode	6-Pin SOT-23A
TC1221	1.8 to 5.5	$V_{OUT} = -V_{IN}$ or $V_{OUT} = 2V_{IN}$	600	25	Shutdown, 125 kHz oscillator	6-Pin SOT-23A
TC1222	1.8 to 5.5	$V_{OUT} = -V_{IN}$ or $V_{OUT} = 2V_{IN}$	2,800	25	Shutdown, 750 kHz oscillator	6-Pin SOT-23A

NOTES 1. Measured at $V_{DD} = 5.0V$ at $25^{\circ}C$ and no load.

2. This product is not recommended for new designs and is on "End-of-Life" status.

POWER MANAGEMENT - Charge Pump DC-to-DC Converters						
Part #	Input Voltage Range (V)	Output Voltage (V)	Maximum Input Current ¹ (μA)	Typical Active Output Current (mA)	Features	Packages
Inverting or Doubling Charge Pumps (continued)						
TC1240	2.5 to 4.0	$V_{OUT} = 2V_{IN}$	900	25	Shutdown, 160 kHz oscillator	6-Pin SOT-23A
TC1240A	2.5 to 5.5	$V_{OUT} = 2V_{IN}$	900	25	Shutdown, 160 kHz oscillator	6-Pin SOT-23A
TCM828	1.5 to 5.5	$V_{OUT} = -V_{IN}$ or $V_{OUT} = 2V_{IN}$	90	25	12 kHz oscillator	5-Pin SOT-23A
TCM829	1.5 to 5.5	$V_{OUT} = -V_{IN}$ or $V_{OUT} = 2V_{IN}$	260	25	35 kHz oscillator	5-Pin SOT-23A
TC7662A	3 to 18	$V_{OUT} = -V_{IN}$ or $V_{OUT} = 2V_{IN}$	200	40	12 kHz oscillator	8-Pin PDIP
TC962	3 to 18	$V_{OUT} = -V_{IN}$ or $V_{OUT} = 2V_{IN}$	200	80		8-Pin PDIP, 16-Pin SOIC
TC1121	2.4 to 5.5	$V_{OUT} = -V_{IN}$ or $V_{OUT} = 2V_{IN}$	100	100	Low power shutdown mode	8-Pin MSOP, 8-Pin PDIP, 8-Pin SOIC
Multi-Function Charge Pumps						
TCM680	2.0 to 5.5	$V_{OUT} = \pm 2V_{IN}$	1,000	±10	Generates ±6V from +3V or ±10V from +5V	8-Pin PDIP, 8-Pin SOIC
Inverting and Doubling Charge Pumps						
TC682	2.4 to 5.5	$V_{OUT} = -2V_{IN}$	400	10	12 kHz oscillator	8-Pin PDIP, 8-Pin SOIC
TC1682 ²	1.8 to 5.5	$V_{OUT} = -2V_{IN}$	160	10	Active high shutdown, 12 kHz oscillator	8-Pin MSOP
TC1683 ²	1.8 to 5.5	$V_{OUT} = -2V_{IN}$	480	10	Active high shutdown, 35 kHz oscillator	8-Pin MSOP
TC1684 ²	1.8 to 5.5	$V_{OUT} = -2V_{IN}$	1,500	10	Active high shutdown, 125 kHz oscillator	8-Pin MSOP
TC2682 ²	1.8 to 5.5	$V_{OUT} = -2V_{IN}$	160	10	12 kHz oscillator	8-Pin MSOP
TC2683 ²	1.8 to 5.5	$V_{OUT} = -2V_{IN}$	480	10	35 kHz oscillator	8-Pin MSOP
TC2684 ²	1.8 to 5.5	$V_{OUT} = -2V_{IN}$	1,500	10	125 kHz oscillator	8-Pin MSOP
TC3682 ²	1.8 to 5.5	$V_{OUT} = -2V_{IN}$	160	10	Active low shutdown, 12 kHz oscillator	8-Pin MSOP
TC3683 ²	1.8 to 5.5	$V_{OUT} = -2V_{IN}$	480	10	Active low shutdown, 35 kHz oscillator	8-Pin MSOP
TC3684 ²	1.8 to 5.5	$V_{OUT} = -2V_{IN}$	1,500	10	Active low shutdown, 125 kHz oscillator	8-Pin MSOP

NOTES 1. Measured at $V_{DD} = 5.0V$ at 25°C and no load.
2. This product is not recommended for new designs and is on "End-of-Life" status.

POWER MANAGEMENT - Charge Pump DC-to-DC Converters

Part #	Input Voltage Range (V)	Output Voltage (V)	Maximum Input Current ¹ (μA)	Typical Active Output Current (mA)	Features	Packages
Regulated Charge Pumps						
TC1142	2.5 to 5.5	-3V to -5V	400	20	Regulated GaAs FET Supply, Internal 200 kHz oscillator, External clock 3 kHz to 500 kHz, Low power shutdown mode	8-Pin MSOP

- NOTES** 1. Measured at VDD = 5.0V at 25°C and no load.
 2. This product is not recommended for new designs and is on "End-of-Life" status.

POWER MANAGEMENT - PWM Controllers

Part #	Type	Input Voltage Range (V)	Quiescent Current (mA)	Maximum Frequency (kHz)
TC170 ¹	Current mode	8 to 16	3.8	200

- NOTES** 1. This product is not recommended for new designs and is on "End-of-Life" status.

POWER MANAGEMENT - CPU/System Supervisors

Part #	Vcc Range (V)	Nominal Reset Voltage (V)	Reset Type	Output	Typical Reset Pulse Width (ms)	Typical Supply Current (µA)	Additional Features	Packages	Bond Options
TC1272	1.2 - 5.5	4.62, 4.37, 4.12	Active Low	CMOS Push-Pull	200	30		3-Pin SOT-23B	N/A
TC1275	1.2 - 5.5	3.06, 2.88, 2.55	Active Low	CMOS Push-Pull	200	28		3-Pin SOT-23B	N/A
TCM809	1.2 - 5.5	4.63, 4.38, 4.00, 3.08, 2.93, 2.63, 2.32*	Active Low	CMOS Push-Pull	240	12		3-Pin STO-23B, 3-Pin SC-70	N/A
TC1270	1.2 - 5.5	4.63, 4.38, 3.08, 2.93, 2.63, 1.75	Active Low	CMOS Push-Pull	280	7	Manual Reset	4-Pin SOT-143	N/A
TCM811	1.2 - 5.5	4.63, 4.38, 3.08, 2.93, 2.63, 1.75	Active Low	CMOS Push-Pull	280	6	Manual Reset	4-Pin SOT-143	N/A
MCP100	1.0 - 5.5	4.72, 4.47, 4.37, 3.075, 2.92, 2.62	Active Low	CMOS Push-Pull	350	32		3-Pin TO-92, 3-Pin SOT-23B	D, H
MCP809	1.0 - 5.5	4.72, 4.47, 4.37, 3.075, 2.92, 2.62	Active Low	CMOS Push-Pull	350	32		3-Pin SOT-23B	N/A
TC1274	1.8 - 5.5	4.62, 4.35, 4.13	Active High	CMOS Push-Pull	200	30		3-Pin SOT-23B	N/A
TC1277	1.2 - 5.5	3.06, 2.88, 2.55	Active High	CMOS Push-Pull	200	28		3-Pin SOT-23B	N/A
TCM810	1.2 - 5.5	4.63, 4.38, 3.08, 2.93, 2.63, 2.32*	Active High	CMOS Push-Pull	240	12		3-Pin SOT-23B, 3-Pin SC-70	N/A
TC1271	1.2 - 5.5	4.63, 4.38, 3.08, 2.93, 2.63, 1.75	Active High	CMOS Push-Pull	280	7	Manual Reset	4-Pin SOT-143	N/A
TCM812	1.2 - 5.5	4.63, 4.38, 3.08, 2.93, 2.63, 1.75	Active High	CMOS Push-Pull	280	6	Manual Reset	4-Pin SOT-143	N/A
MCP101	1.0 - 5.5	4.72, 4.47, 4.37, 3.075, 2.92, 2.62	Active High	CMOS Push-Pull	350	32		3-Pin TO-92, 3-Pin SOT-23B	D, H
MCP810	1.0 - 5.5	4.72, 4.47, 4.37, 3.075, 2.92, 2.62	Active High	CMOS Push-Pull	350	32		3-Pin SOT-23B	N/A
TC1273	1.2 - 5.5	4.62, 4.35, 4.13	Active Low	Open drain	200	30		3-Pin SOT-23B	N/A
TC1276	1.2 - 5.5	3.06, 2.88, 2.55	Active Low	Open drain	200	28		3-Pin SOT-23B	N/A
MCP120	1.0 - 5.5	4.72, 4.47, 4.37, 3.075, 2.92, 2.62	Active Low	Open drain	350	32		3-Pin TO-92, 3-Pin SOT-23, 8-Pin SOIC	D, G, H
TC1279	1.2 - 5.5	4.62, 4.37, 4.125	Active Low	Open drain	350	1500		3-Pin SOT-23B	N/A
TC32M	4.5 - 5.5	4.5	Active Low	Open drain	500	50	Watchdog Timer	3-Pin TO-92, 3-Pin SOT-223	N/A
TC1232	4.5 - 5.5	4.37, 4.62	Active Low/ High	Open drain	610	50	Watchdog Timer	8-Pin PDIP, 8-Pin SOIC, 16-Pin SOIC	N/A
MCP130	1.0 - 5.5	4.72, 4.47, 4.37, 3.075, 2.92, 2.62	Active Low	Open drain W/5k ohm Pull-up	350	32		3-Pin TO-92, 3-Pin SOT-23, 8-Pin SOIC	D, F, H
TC1278	1.8 - 5.5	4.62, 4.37, 4.125	Active High	Open drain	350	1500		3-Pin SOT-23B	N/A

*2.32V option only available in SC-70 package.

POWER MANAGEMENT - Voltage Detectors

Part #	Vcc Range (V)	Nominal Reset Voltage (V)	Reset Type	Output	Minimum Reset Pulse Width (ms)	Typical Supply Current (μ A)	Features	Packages
TC51	0.7 to 10	2.2, 2.7, 3.0	Active low	Open drain	50	1	RESET delay	3-Pin SOT-23A
TC52	1.5 to 10	4.5/2.7, 5.0/2.7	Active low	Open drain	—	2	Dual channel	5-Pin SOT-23A
TC53	1.0 to 10	2.2, 2.7, 2.9	Active low	CMOS push-pull or Open drain	—	1		3-Pin SOT-23A, 5-Pin SOT-23A
TC54	0.7 to 10	1.1 to 6.0 in 100mV increments	Active low	CMOS push-pull or Open drain	—	1		3-Pin SOT-23A, 3-Pin SOT-89, 3-Pin TO-92

POWER MANAGEMENT - Power MOSFET Drivers

Part #	Configuration	Peak Output Current (A)	Output Resistance (R _H /R _L) (Max Ω @ 25°C)	Max Supply Voltage (V)	Input/Output Delay (t_{d1} , t_{d2}) (ns)	Packages
Low-Side Drivers, 0.5A to 1.2A Peak Output Current						
TC1410	Single, Inverting	0.5	22/22	16	30/30	8-Pin PDIP, 8-Pin SOIC
TC1410N	Single, Non-inverting	0.5	22/22	16	30/30	8-Pin PDIP, 8-Pin SOIC
TC1411	Single, Inverting	1	11/11	16	30/30	8-Pin PDIP, 8-Pin SOIC
TC1411N	Single, Non-inverting	1	11/11	16	30/30	8-Pin PDIP, 8-Pin SOIC
TC1426	Dual, Inverting	1.2	18/18	16	75/75	8-Pin PDIP, 8-Pin SOIC
TC1427	Dual, Non-inverting	1.2	18/18	16	75/75	8-Pin PDIP, 8-Pin SOIC
TC1428	Dual, Inverting and Non-inverting	1.2	18/18	16	75/75	8-Pin PDIP, 8-Pin SOIC
TC4467	Quad, Inverting	1.2	15/15	18	40/40	14-Pin PDIP, 16-Pin SOIC (W)
TC4468	Quad, Non-inverting	1.2	15/15	18	40/40	14-Pin PDIP, 16-Pin SOIC (W)
TC4469	Quad, Non-inverting	1.2	15/15	18	40/40	14-Pin PDIP, 16-Pin SOIC (W)
Low-Side Drivers, 1.5A Peak Output Current						
TC4426A	Dual, Inverting	1.5	9/9	18	30/30	8-Pin PDIP, 8-Pin SOIC
TC4427A	Dual, Non-inverting	1.5	9/9	18	30/30	8-Pin PDIP, 8-Pin SOIC

Note: * t_{d1} = delay time from input low-to-high transition to output transition. t_{d2} = delay time from input high-to-low transition to output transition.

POWER MANAGEMENT - Power MOSFET Drivers

Part #	Configuration	Peak Output Current (A)	Output Resistance (RH/RL) (Max Ω @ 25°C)	Max Supply Voltage (V)	Input/Output Delay (td1, td2*) (ns)	Packages
Low-Side Drivers, 1.5A Peak Output Current (continued)						
TC4403	Single, Non-inverting Floating Load Driver	1.5	5/5	18	33/38	8-Pin PDIP
TC4428A	Dual, Inverting and Non-inverting	1.5	9/9	18	30/30	8-Pin PDIP, 8-Pin SOIC
TC4426	Dual, Inverting	1.5	10/10	18	20/40	8-Pin PDIP, 8-Pin SOIC
TC4427	Dual, Non-inverting	1.5	10/10	18	20/40	8-Pin PDIP, 8-Pin SOIC
TC4428	Dual, Inverting and Non-inverting	1.5	10/10	18	20/40	8-Pin PDIP, 8-Pin SOIC
TC4426	Dual, Inverting	1.5	15/10	18	50/75	8-Pin PDIP, 8-Pin SOIC
TC4427	Dual, Non-inverting	1.5	15/10	18	50/75	8-Pin PDIP, 8-Pin SOIC
TC4428	Dual, Inverting and Non-inverting	1.5	15/10	18	50/75	8-Pin PDIP, 8-Pin SOIC
TC4404	Dual, Inverting	1.5	10/10	18	15/32	8-Pin PDIP, 8-Pin SOIC
TC4405	Dual, Non-inverting	1.5	10/10	18	15/32	8-Pin PDIP, 8-Pin SOIC
Low-Side Drivers, 2.0A to 9.0A Peak Output Current						
TC1412	Single, Inverting	2	6/6	16	35/35	8-Pin PDIP, 8-Pin SOIC
TC1412N	Single, Non-inverting	2	6/6	16	35/35	8-Pin PDIP, 8-Pin SOIC
TC1413	Single, Inverting	3	4/4	16	35/35	8-Pin PDIP, 8-Pin SOIC
TC1413N	Single, Non-inverting	3	4/4	16	35/35	8-Pin PDIP, 8-Pin SOIC
TC4423	Dual, Inverting	3	5/5	18	33/38	8-Pin PDIP, 16-Pin SOIC (W), 8-Pin MLF
TC4424	Dual, Non-inverting	3	5/5	18	33/38	8-Pin PDIP, 16-Pin SOIC (W), 8-Pin MLF
TC4425	Dual, Inverting and Non-inverting	3	5/5	18	33/38	8-Pin PDIP, 16-Pin SOIC (W), 8-Pin MLF
TC429	Single, Inverting	6	2.5/2.5	18	53.60	8-Pin PDIP, 8-Pin MLF
TC4420	Single, Non-inverting	6	2.8/2.5	18	55/55	8-Pin PDIP, 8-Pin SOIC, 5-Pin TO-220
TC4429	Single, Inverting	6	2.8/2.5	18	55/55	8-Pin PDIP, 8-Pin SOIC, 5-Pin TO-220
TC4421	Single, Inverting	9	1.4 (typ)/1.7	18	30/33	8-Pin PDIP, 5-Pin TO-220, 8-Pin MLF
TC4422	Single, Non-inverting	9	1.4 (typ)/1.7	18	30/33	8-Pin PDIP, 5-Pin TO-220, 8-Pin MLF

Note: *td1 = delay time from input low-to-high transition to output transition. td2 = delay time from input high-to-low transition to output transition.

POWER MANAGEMENT - Power MOSFET Drivers

Part #	Configuration	Peak Output Current (A)	Output Resistance (R _H /R _L) (Max Ω @ 25°C)	Max Supply Voltage (V)	Input/Output Delay (t _{d1} , t _{d2}) (ns)	Packages
High-Side/Low-Side Drivers						
TC4626	Single, Inverting	1.5	15/10	6	35/45	8-Pin PDIP, 16-Pin SOIC (W)
TC4627	Single, Non-inverting	1.5	15/10	6	35/45	8-Pin PDIP, 16-Pin SOIC (W)
TC4431	Single, Inverting	1.5	10/10	30	62/78	8-Pin PDIP, 8-Pin SOIC
TC4432	Single, Non-inverting	1.5	10/10	30	62/78	8-Pin PDIP, 8-Pin SOIC

Note: *t_{d1} = delay time from input low-to-high transition to output transition. t_{d2} = delay time from input high-to-low transition to output transition.

POWER MANAGEMENT - Battery Chargers

Part#	Mode	Cell Type	V _{CC} Range (V)	Typical Supply Current (mA)	Features	Packages
MCP73826	Linear	Single Cell Lithium-Ion	4.5 to 5.5	260	Small size	6-Pin SOT-23A
MCP73827	Linear	Single Cell Lithium-Ion	4.5 to 5.5	250	Mode indicator, charge current monitor	8-Pin MSOP
MCP73828	Linear	Single Cell Lithium-Ion	4.5 to 5.5	265	Charge complete indicator, Temperature monitor	8-Pin MSOP

LINEAR - Op Amps

Part #	# per Package	GBWP	I _Q Typical (μA)	V _{OS} Max (mV)	Operating Voltage (V)	Temp. Range (°C)	Features	Packages
TC1029	2	90 kHz	6	1.5	1.8 to 5.5	-40 to +85		8-Pin PDIP, 8-Pin MSOP, 8-Pin SOIC
TC1030	4	90 kHz	5	1.5	1.8 to 5.5	-40 to +85	Shutdown pins	16-Pin QSOP
TC1034	1	90 kHz	6	1.5	1.8 to 5.5	-40 to +85		5-Pin SOT-23A
TC1035	1	90 kHz	6	1.5	1.8 to 5.5	-40 to +85	Shutdown pin	6-Pin SOT-23A
MCP601	1	2.8 MHz	230	2	2.7 to 5.5	-40 to +85	Rail-to-Rail output	8-Pin PDIP, 8-Pin SOIC, 8-Pin TSSOP, 8-Pin SOT-23A
MCP602	2	2.8 MHz	230	2	2.7 to 5.5	-40 to +85	Rail-to-Rail output	8-Pin PDIP, 8-Pin SOIC, 8-Pin TSSOP
MCP603	1	2.8 MHz	230	2	2.7 to 5.5	-40 to +85	Chip Select, Rail-to-Rail output	8-Pin PDIP, 8-Pin SOIC, 8-Pin TSSOP
MCP604	4	2.8 MHz	230	2	2.7 to 5.5	-40 to +85	Rail-to-Rail output	14-Pin PDIP, 14-Pin SOIC, 14-Pin TSSOP

LINEAR - Op Amps								
Part #	# per Package	GBWP	Iq Typical (µA)	Vos Max (mV)	Operating Voltage (V)	Temp. Range (°C)	Features	Packages
MCP606	1	155 kHz	19	0.25	2.5 to 5.5	-40 to +85	Rail-to-Rail output	8-Pin PDIP, 8-Pin SN, 8-Pin TSSOP
MCP607	2	155 kHz	19	0.25	2.5 to 5.5	-40 to +85	Rail-to-Rail output	8-Pin PDIP, 8-Pin SOIC, 8-Pin TSSOP
MCP608	1	155 kHz	19	0.25	2.5 to 5.5	-40 to +85	Chip Select, Rail-to-Rail output	8-Pin PDIP, 8-Pin SOIC, 8-Pin TSSOP
MCP609	4	155 kHz	19	0.25	2.5 to 5.5	-40 to +85	Rail-to-Rail output	14-Pin PDIP, 14-Pin SOIC, 14-Pin TSSOP
MCP616	1	190 kHz	19	0.15	2.3 to 5.5	-40 to +85	Rail-to-Rail output	8-Pin PDIP, 8-Pin SOIC, 8-Pin MSOP
MCP617	2	190 kHz	19	0.15	2.3 to 5.5	-40 to +85	Rail-to-Rail output	8-Pin PDIP, 8-Pin SOIC, 8-Pin MSOP
MCP618	1	190 kHz	19	0.15	2.3 to 5.5	-40 to +85	Chip Select, Rail-to-Rail output	8-Pin PDIP, 8-Pin SOIC, 8-Pin MSOP
MCP619	4	190 kHz	19	0.15	2.3 to 5.5	-40 to +85	Rail-to-Rail output	14-Pin PDIP, 14-Pin SOIC, 14-Pin TSSOP
MCP6021	1	10 MHz	1100	0.5	2.5 to 5.5	-40 to +85	Rail-to-Rail Input/Output	8-Pin PDIP, 8-Pin SOIC, 8-Pin TSSOP
MCP6022	2	10 MHz	1100	0.5	2.5 to 5.5	-40 to +85	Rail-to-Rail Input/Output	8-Pin PDIP, 8-Pin SOIC, 8-Pin TSSOP
MCP6023	1	10 MHz	1100	0.5	2.5 to 5.5	-40 to +85	Rail-to-Rail Input/Output, Chip Select	8-Pin PDIP, 8-Pin SOIC, 8-Pin TSSOP
MCP6024	4	10 MHz	1100	0.5	2.5 to 5.5	-40 to +85	Rail-to-Rail Input/Output	14-Pin PDIP, 14-Pin SOIC, 14-Pin TSSOP
MCP6041	1	14 kHz	0.6	3	1.4 to 5.5	-40 to +85	Rail-to-Rail Input/Output	8-Pin PDIP, 8-Pin SOIC, 8-Pin MSOP
MCP6042	2	14 kHz	0.6	3	1.4 to 5.5	-40 to +85	Rail-to-Rail Input/Output	8-Pin PDIP, 8-Pin SOIC, 8-Pin MSOP
MCP6043	1	14 kHz	0.6	3	1.4 to 5.5	-40 to +85	Rail-to-Rail Input/Output, Chip Select	8-Pin PDIP, 8-Pin SOIC, 8-Pin MSOP
MCP6044	4	14 kHz	0.6	3	1.4 to 5.5	-40 to +85	Rail-to-Rail Input/Output	14-Pin PDIP, 14-Pin SOIC, 14-Pin TSSOP

Note: All TC10XX Op Amps have rail-to-rail inputs and outputs.

LINEAR - Comparators								
Part #	# per Package	VREF (V)	Iq Typical (µA)	Vos Max (mV)	Operating Voltage (V)	Temp. Range (°C)	Features	Packages
TC1025	2	—	8	5	1.8 to 5.5	-40 to +85		8-Pin PDIP, 8-Pin MSOP, 8-Pin SOIC
TC1027	4	1.2	18	5	1.8 to 5.5	-40 to +85	On-board VREF	16-Pin PDIP, 16-Pin QSOP, 16-Pin SOIC
TC1028	2	1.2	10	5	1.8 to 5.5	-40 to +85	Shutdown pins, On-board VREF	8-Pin MSOP
TC1031	1	1.2	6	5	1.8 to 5.5	-40 to +85	On-board VREF, Programmable hysteresis, Shutdown pin	8-Pin MSOP

LINEAR - Comparators

Part #	# per Package	VREF (V)	Iq Typical (μ A)	Vos Max (mV)	Operating Voltage (V)	Temp. Range ($^{\circ}$ C)	Features	Packages
TC1037	1	—	4	5	1.8 to 5.5	-40 to +85		5-Pin SOT-23A
TC1038	1	—	4	5	1.8 to 5.5	-40 to +85	Shutdown pin	6-Pin SOT-23A
TC1039	1	1.2	6	5	1.8 to 5.5	-40 to +85	On-board VREF	6-Pin SOT-23A
TC1040	2	1.2	10	5	1.8 to 5.5	-40 to +85	On-board VREF, Shutdown pin	8-Pin MSOP
TC1041	2	1.2	10	5	1.8 to 5.5	-40 to +85	On-board VREF, Programmable hysteresis	8-Pin MSOP, 8-Pin SOIC
MCP6541	1	—	1	5	1.8 to 5.5	-40 to +85	Push-Pull, Rail-to-Rail Input/Output	8-pin PDIP, 8-pin SOIC, 8-pin MSOP
MCP6542	2	—	1	5	1.8 to 5.5	-40 to +85	Push-Pull, Rail-to-Rail Input/Output	8-pin PDIP, 8-pin SOIC, 8-pin MSOP
MCP6543	1	—	1	5	1.8 to 5.5	-40 to +85	Push-Pull, Chip Select, Rail-to-Rail Input/Output	8-pin PDIP, 8-pin SOIC, 8-pin MSOP
MCP6544	4	—	1	5	1.8 to 5.5	-40 to +85	Push-Pull, Rail-to-Rail Input/Output	14-pin PDIP, 14-pin SOIC, 14-pin TSSOP
MCP6546	1	—	1	5	1.8 to 5.5	-40 to +85	Open Drain, 9V, Rail-to-Rail Input/Output	8-pin PDIP, 8-pin SOIC, 8-pin MSOP
MCP6547	2	—	1	5	1.8 to 5.5	-40 to +85	Open Drain, 9V, Rail-to-Rail Input/Output	8-pin PDIP, 8-pin SOIC, 8-pin MSOP
MCP6548	1	—	1	5	1.8 to 5.5	-40 to +85	Open Drain, 9V, Chip Select, Rail-to-Rail Input/Output	8-pin PDIP, 8-pin SOIC, 8-pin MSOP
MCP6549	4	—	1	5	1.8 to 5.5	-40 to +85	Open Drain, 9V, Rail-to-Rail Input/Output	14-pin PDIP, 14-pin SOIC, 14-pin TSSOP

Note: All Comparators have rail-to-rail inputs and outputs

LINEAR - Integrated Devices

Part #	# of Op Amps per Package	# of Comparators per Package	Iq Typical (μ A)	VREF (V)	Operating Voltage (V)	Temp. Range ($^{\circ}$ C)	Features	Packages
TC1026	1	1	12	1.2	1.8 to 5.5	-40 to +85	On-board VREF	8-Pin PDIP, 8-Pin MSOP, 8-Pin SOIC
TC1043	2	2	16	1.2	1.8 to 5.5	-40 to +85	On-board VREF, Shutdown pin	16-Pin QSOP

LINEAR - Audio Amplifiers

Part #	# of Channels	Supply Voltage Range (V)	Power at 8 Ohms, THD L = 1% (Watts)	Power at 16 Ohms, THD L = 1% (Watts)	Typical Supply Current (mA)	Typical THD Rating (%)	Packages
TC4864	1	2.7 to 5.5	0.74	0.59	4.1	0.1	8-Pin MSOP

MIXED SIGNAL - Successive Approximation Register (SAR) A/D Converters

Part #	Resolution (bits)	Maximum Sampling Rate (ksamples/sec)	# of Input Channels	Input Type	Interface	Input Voltage Range (V)	Typical Supply Current (μ A)	Max. INL	Packages
MCP3001	10	200	1	Single-ended	SPI	2.7 to 5.5	500	± 1 LSB	8-Pin PDIP, 8-Pin SOIC, 8-Pin TSSOP
MCP3002	10	200	2	Single-ended	SPI	2.7 to 5.5	650	± 1 LSB	8-Pin PDIP, 8-Pin SOIC, 8-Pin TSSOP
MCP3004	10	200	4	Single-ended	SPI	2.7 to 5.5	550	± 1 LSB	14-Pin PDIP, 14-Pin SOIC, 14-Pin TSSOP
MCP3008	10	200	8	Single-ended	SPI	2.7 to 5.5	550	± 1 LSB	16-Pin PDIP, 16-Pin SOIC
MCP3201	12	100	1	Single-ended	SPI	2.7 to 5.5	400	± 1 LSB	8-Pin PDIP, 8-Pin SOIC, 8-Pin TSSOP
MCP3202	12	100	2	Single-ended	SPI	2.7 to 5.5	550	± 1 LSB	8-Pin PDIP, 8-Pin SOIC, 8-Pin TSSOP
MCP3204	12	100	4	Single-ended	SPI	2.7 to 5.5	400	± 1 LSB	14-Pin PDIP, 14-Pin SOIC, 14-Pin TSSOP
MCP3208	12	100	8	Single-ended	SPI	2.7 to 5.5	400	± 1 LSB	16-Pin PDIP, 16-Pin SOIC
MCP3301	13	100	1	Differential	SPI	2.7 to 5.5	450	± 1 LSB	8-Pin PDIP, 8-Pin SOIC, 8-Pin MSOP
MCP3302	13	100	2	Differential	SPI	2.7 to 5.5	450	± 1 LSB	14-Pin PDIP, 14-Pin SOIC, 14-Pin TSSOP
MCP3304	13	100	4	Differential	SPI	2.7 to 5.5	450	± 1 LSB	16-Pin PDIP, 16-Pin SOIC
MCP3221	12	22	1	Single-ended	I ² C	2.7 to 5.5	110	± 2 LSB	5-Pin SOT-23A, 8-Pin PDIP

MIXED SIGNAL - Sigma-Delta A/D Converters

Part #	Resolution (bits)	Maximum Sampling Rate (samples/sec)	# of Input Channels	Interface	Supply Voltage Range (V)	Typical Supply Current (μ A)	Typical INL (%FSR)	Features	Packages
TC3400	10 to 16*	>400	1 Diff	2-Wire	1.8 to 5.5	260	0.0038		8-Pin PDIP, 8-Pin SOIC
TC3401	10 to 16*	>400	2 Diff	2-Wire	1.8 to 5.5	300	0.0038	Enable mode, RESET monitor, Power-fail monitor	16-Pin PDIP, 16-Pin QSOP
TC3402	10 to 16*	>400	4 Diff	2-Wire	1.8 to 5.5	250	0.0038		16-Pin PDIP, 16-Pin QSOP
TC3403	10 to 16*	>400	4 Single-ended	2-Wire	1.8 to 5.5	280	0.0038	RESET monitor, Power-fail monitor	16-Pin PDIP, 16-Pin QSOP
TC3404	10 to 16*	>400	2 Single-ended, 2 Diff	2-Wire	1.8 to 5.5	280	0.0038	Power-fail monitor	16-Pin PDIP, 16-Pin QSOP
TC3405	10 to 16*	>400	3 Single-ended, 1 Diff	2-Wire	1.8 to 5.5	250	0.0038	Enable mode, RESET monitor	16-Pin PDIP, 16-Pin QSOP

Note: All TC340X are Sigma-Delta A/D Converters that can use the internal VREF or an external VREF and have adjustable resolution.

MIXED SIGNAL - Dual Slope A/D Converters

Part #	Supply Voltage (V)	Input Voltage Range (V)	Resolution	Sampling Rate (Conv/s)	Input Channels	Data Interface	Features	Packages
TC500	±4.5 to ±7.5	VSS +1.5V to VDD -1.5V	Up to 16 bits	4 to 10	1	3 Wire	Differential input range, Programmable resolution/conversion time	16-Pin PDIP, 16-Pin SOIC, 16-Pin CerDIP
TC500A	±4.5 to ±7.5	VSS +1.5V to VDD -1.5V	Up to 17 bits	4 to 10	1	3 Wire	Differential input range, Programmable resolution/conversion time	16-Pin PDIP, 16-Pin SOIC, 16-Pin CerDIP
TC510	+4.5 to +5.5	VSS +1.5V to VDD -1.5V	Up to 17 bits	4 to 10	1	3 Wire	Differential input range, Programmable resolution/conversion time, Charge pump (-V) output pin	24-Pin PDIP, 24-Pin SOIC
TC514	+4.5 to +5.5	VSS +1.5V to VDD -1.5V	Up to 17 bits	4 to 10	4	3 Wire	Differential input range, Programmable resolution/conversion time, Charge pump (-V) output pin	28-Pin PDIP, 28-Pin SOIC
TC520A	+4.5 to +5.5	—	—	—	—	Serial port	Optional serial interface adapter for TC500/500A/510/514	14-Pin PDIP, 16-Pin SOIC
TC530	+4.5 to +5.5	VSS +1.5V to VDD -1.5V	Up to 17 bits	3 to 10	1	Serial port	Differential input range, Programmable resolution/conversion time, Charge pump (-V) output pin	28-Pin PDIP, 28-Pin SOIC
TC534	+4.5 to +5.5	VSS +1.5V to VDD -1.5V	Up to 17 bits	3 to 10	4	Serial port	Differential input range, Programmable resolution/conversion time, Charge pump (-V) output pin	40-Pin PDIP, 44-Pin PQFP
TC7109	±4.5 to ±5.5	VSS +1.5V to VDD -1.0V	12 bits plus sign bit	2 to 10	1	Parallel or Serial port	Differential input range	40-Pin PDIP, 40-Pin CerDip, 44-Pin PLCC, 44-Pin PQFP
TC7109A	±4.5 to ±5.5	VSS +1.5V to VDD -1.0V	12 bits plus sign bit	2 to 10	1	Parallel or Serial port	Differential input range	40-Pin PDIP, 40-Pin CerDip, 44-Pin PLCC, 44-Pin PQFP

MIXED SIGNAL - Binary and BCD A/D Converters

Part #	Description	Supply Voltage (V)	Input Voltage Range (V)	Resolution (Digits)	Resolution (Counts)	Max Power (mW)	Data Interface	Features	Packages
TC835	BCD A/D	±5	VSS + 1.0V to VDD - 0.5V	4½	±20,000	30	MUXed BCD	Upgrade to TC7135	64-Pin PQFP, 44-Pin PQFP, 28-Pin PDIP
TC850	Binary A/D	±5	VSS + 1.5V to VDD - 1.5V	15 bit	±32,768	35	8-bit parallel	Highest conversion speed (40 conv/sec)	44-Pin PLCC, 40-Pin PDIP, 40-Pin CerDIP
TC7135	BCD A/D	±5	VSS + 1.0V to VDD - 1.0V	4½	±20,000	30	MUXed BCD	For DMM, DPM, dataloggers	28-Pin PLCC, 28-Pin PDIP, 64-Pin PQFP
TC14433	BCD A/D	±4.5 to ±8	±199.9mV to 1.999V	3½	±2,000	20	MUXed BCD	For DMM, DPM, dataloggers	24-Pin SOIC, 24-Pin PDIP, 28-Pin PLCC, 24-Pin CerDIP
TC14433A	BCD A/D	±4.5 to ±8	±199.9mV to 1.999V	3½	±2,000	20	MUXed BCD	For DMM, DPM, dataloggers	24-Pin PDIP, 28-Pin PLCC, 24-Pin CerDIP

MIXED SIGNAL - Display A/D Converters							
Part #	Display Type	Supply Voltage (V)	Resolution (Digits)	Resolution (Counts)	Power (mW)	Features	Packages
TC815	LCD	9	3½	±2,000	10	Triplex LCD Drive, Hold function	64-Pin PQFP
TC818A	LCD	9	3½	±2,000	10	Triplex LCD Drive	64-Pin PQFP
TC820	LCD	9	3¾	±4,000	10	DMM plus frequency counter and logic probe	40-Pin PDIP, 44-Pin PLCC, 44-Pin PQFP
TC826	LCD	9	2.5% Bar	—	20	Hold, Non-MUXed LCD drive, 40 data segments plus zero	64-Pin PQFP
TC7106	LCD	9	3½	±2,000	10	For DMM, DPM, datalogger applications	40-Pin PDIP, 44-Pin PLCC, 44-Pin PQFP, 40-Pin CerDIP
TC7106A	LCD	9	3½	±2,000	10	For DMM, DPM, datalogger applications	40-Pin PDIP, 44-Pin PLCC, 44-Pin PQFP, 40-Pin CerDIP
TC7107	LED	±5	3½	±2,000	10	For DMM, DPM, datalogger applications	40-Pin PDIP, 44-Pin PLCC, 44-Pin PQFP, 40-Pin CerDIP
TC7107A	LED	±5	3½	±2,000	10	For DMM, DPM, datalogger applications	40-Pin PDIP, 44-Pin PLCC, 44-Pin PQFP, 40-Pin CerDIP
TC7116	LCD	9	3½	±2,000	10	Hold function	40-Pin PDIP, 44-Pin PLCC, 44-Pin PQFP, 40-Pin CerDIP
TC7116A	LCD	9	3½	±2,000	10	Hold function	40-Pin PDIP, 44-Pin PLCC, 44-Pin PQFP, 40-Pin CerDIP
TC7117	LED	±5	3½	±2,000	10	Hold function	40-Pin PDIP, 44-Pin PLCC, 44-Pin PQFP, 40-Pin CerDIP
TC7117A	LED	±5	3½	±2,000	10	Hold function	40-Pin PDIP, 44-Pin PLCC, 44-Pin PQFP, 40-Pin CerDIP
TC7126	LCD	9	3½	±2,000	0.5	Low power TC7106	40-Pin PDIP, 44-Pin PLCC, 44-Pin PQFP, 40-Pin CerDIP
TC7126A	LCD	9	3½	±2,000	0.5	Low power TC7106	40-Pin PDIP, 44-Pin PLCC, 44-Pin PQFP, 40-Pin CerDIP
TC7129	LCD	9	4½	±20,000	4.5	Lowest noise ±3µV sensitivity	40-Pin PDIP, 44-Pin PLCC, 44-Pin PQFP
TC7136	LCD	9	3½	±2,000	0.5	Low power/noise TC7106	40-Pin PDIP, 44-Pin PLCC, 44-Pin PQFP
TC7136A	LCD	9	3½	±2,000	0.5	Low power/noise TC7106	40-Pin PDIP, 44-Pin PLCC, 44-Pin PQFP

MIXED SIGNAL - Digital Potentiometers

Part #	Number of Taps	Number per Package	Interface	Resistance (ohms)	INL (max)	DNL (max)	Packages
MCP41010	256	1	SPI	10K	±1 LSB	±1 LSB	8-Pin PDIP, 8-Pin SOIC
MCP41050	256	1	SPI	50K	±1 LSB	±1 LSB	8-Pin PDIP, 8-Pin SOIC
MCP41100	256	1	SPI	100K	±1 LSB	±1 LSB	8-Pin PDIP, 8-Pin SOIC
MCP42010	256	2	SPI	10K	±1 LSB	±1 LSB	14-Pin PDIP, 14-Pin SOIC, 14-Pin TSSOP
MCP42050	256	2	SPI	50K	±1 LSB	±1 LSB	14-Pin PDIP, 14-Pin SOIC, 14-Pin TSSOP
MCP42100	256	2	SPI	100K	±1 LSB	±1 LSB	14-Pin PDIP, 14-Pin SOIC, 14-Pin TSSOP

MIXED SIGNAL - Frequency-to-Voltage/Voltage-to-Frequency Converters

Part #	Frequency Range (kHz)	Full Scale (ppm FS/°C)	Non-linearity (%FS)	Packages
TC9400	100	±40	±0.05	14-Pin PDIP, 14-Pin SOIC
TC9401	100	±40	±0.02	14-Pin PDIP, 14-Pin SOIC
TC9402	100	±100	±0.25	14-Pin PDIP, 14-Pin SOIC

MIXED SIGNAL - System D/A Converters

Part #	Resolution (Bits)	DACs per Package	Interface	VREF	Output Settling Time (µs)	DNL (LSB)	Typical Standby Current (µA)	Typical Operating Current (µA)	Packages
TC1320	8	1	SMBus	Ext	10	±0.8	0.1	350	8-Pin MSOP, 8-Pin SOIC
TC1321	10	1	SMBus	Ext	10	±2	0.1	350	8-Pin MSOP, 8-Pin SOIC
TC1322	12	1	SMBus	Ext	10	±4	0.1	350	8-Pin MSOP, 8-Pin SOIC

Note: The analog output is voltage.

INTERFACE PRODUCTS - CONTROLLER AREA NETWORK (CAN) Devices

Part #	Operating Voltage (V)	Temperature Range (°C)	Tx Buffers	Rx Buffers	Filters	Masks	Interrupt Output	Unique Features	Packages
MCP2510	2.7 to 5.5	-40 to 125	3	2	6	2	Yes	CAN 2.0B Active controller with SPI interface to MCU, 3 transmit buffers, 2 receive buffers, HW and SW message triggers.	18-Pin PDIP, 18-Pin SOIC, 20-Pin TSSOP
MCP25020	2.7 to 5.5	-40 to 125	3	2	2	1	N/A	CAN 2.0B Active I/O Expander, configurable I/O, 2 PWM outputs	14-Pin PDIP, 14-Pin SOIC
MCP25025	2.7 to 5.5	-40 to 85	3	2	2	1	N/A	CAN 2.0B Active I/O Expander, configurable I/O, 2 PWM outputs, one-wire CAN option	14-Pin PDIP, 14-Pin SOIC
MCP25050	2.7 to 5.5	-40 to 125	3	2	2	1	N/A	Mixed-Signal CAN 2.0B Active I/O Expander, configurable I/O, 4 10-bit ADCs, 2 PWM outputs	14-Pin PDIP, 14-Pin SOIC
MCP25055	2.7 to 5.5	-40 to 85	3	2	2	1	N/A	Mixed-Signal CAN 2.0B Active I/O Expander, configurable I/O, 4 10-bit ADCs, 2 PWM outputs, one-wire CAN option	14-Pin PDIP, 14-Pin SOIC

INTERFACE PRODUCTS - INFRARED PRODUCTS

Part #	Operating Voltage (V)	Temperature Range (°C)	Max. Baud Rate (kHz)	Unique Features	Packages
MCP2120	2.5 to 5.5	-40 to +85	325	UART to IR encoder/decoder with both hardware and software baud rate selection	14-Pin PDIP, 14-Pin SOIC
MCP2150	3.0 to 5.5	-40 to +85	115.2	IrDA® Standard protocol handler plus bit encoder/decoder on one chip for DTE applications, Programmable ID	18-Pin PDIP, 18-Pin SOIC, 20-Pin SSOP
MCP2155	3.0 to 5.5	-40 to +85	115.2	IrDA Standard protocol handler plus bit encoder/decoder on one chip for DCE applications, Programmable ID	18-Pin PDIP, 18-Pin SOIC, 20-Pin SSOP

IrDA is a registered trademark of Infrared Data Association.

SERIAL ELECTRICALLY ERASABLE PROMS (EEPROM)

Product	E/W Cycles	Density (Organization)	Write Speed	Max. Clock Freq.	Operating Voltage	Unique Features	Packages
3-Wire Serial EEPROM Family							
93C46A	1M	1K bits (x8)	2 ms	2 MHz	4.5V to 5.5V	All devices listed in this group are recommended for extended temperature applications only. All other applications should use 93LCx6A/B devices. No ORG pin - 93CXXA (x8) No ORG pin - 93CXXB (x16)	P, SN, ST
93C46B	1M	1K bits (x16)	2 ms	2 MHz	4.5V to 5.5V		P, SN, ST
93C56A	1M	2K bits (x8)	2 ms	2 MHz	4.5V to 5.5V		P, SN
93C56B	1M	2K bits (x16)	2 ms	2 MHz	4.5V to 5.5V		P, SN
93C66A	1M	4K bits (x8)	2 ms	2 MHz	4.5V to 5.5V		P, SN
93C66B	1M	4K bits (x16)	2 ms	2 MHz	4.5V to 5.5V		P, SN
93C76	1M	8K bits (x8 or x16)	5 ms	2 MHz	4.5V to 5.5V	User selectable mode via ORG pin	P, SN
93C86	1M	16K bits (x8 or x16)	5 ms	2 MHz	4.5V to 5.5V		P, SN
93LC46	1M	1K bits (x8 or x16)	10 ms	2 MHz	2.0V to 6.0V	User selectable mode via ORG pin	P, SN
93LC56	1M	2K bits (x8 or x16)	10 ms	2 MHz	2.0V to 6.0V		P, SN
93LC66	1M	4K bits (x8 or x16)	10 ms	2 MHz	2.0V to 6.0V		P, SN
93LC76	1M	8K bits (x8 or x16)	5 ms	2 MHz	2.0V to 6.0V		P, SN
93LC86	1M	16K bits (x8 or x16)	5 ms	2 MHz	2.0V to 6.0V		P, SN
93LC46A	1M	1K bits (x8)	5 ms	2 MHz	2.5V to 6.0V	No ORG pin - 93LCXXA (x8) No ORG pin - 93LCXXB (x16)	P, SN, ST, MS
93LC46B	1M	1K bits (x16)	5 ms	2 MHz	2.5V to 6.0V		P, SN, ST, MS
93LC56A	1M	2K bits (x8)	6 ms	2 MHz	2.5V to 6.0V		P, SN, ST, MS
93LC56B	1M	2K bits (x16)	6 ms	2 MHz	2.5V to 6.0V		P, SN, ST, MS
93LC66A	1M	4K bits (x8)	6 ms	2 MHz	2.5V to 6.0V		P, SN, ST, MS
93LC66B	1M	4K bits (x16)	6 ms	2 MHz	2.5V to 6.0V		P, SN, ST, MS
93AA46	1M	1K bits (x8 or x16)	10 ms	2 MHz	1.8V to 5.5V	User selectable mode via ORG pin	P, SN, MS
93AA56	1M	2K bits (x8 or x16)	10 ms	2 MHz	1.8V to 5.5V		P, SN
93AA66	1M	4K bits (x8 or x16)	10 ms	2 MHz	1.8V to 5.5V		P, SN
93AA76	1M	8K bits (x8 or x16)	5 ms	2 MHz	1.8V to 5.5V		P, SN
93AA86	1M	16K bits (x8 or x16)	5 ms	2 MHz	1.8V to 5.5V		P, SN
Special Features: Automatic ERAL before WRAL, self-timed erase and write cycle, power on/off data protection circuitry, sequential read function and industry standard 3-wire serial I/O							
2-Wire I²C Serial EEPROM Family**							
24C00	1M	128 bits (x8)	4 ms	400 kHz	4.5V to 5.5V	5-pin SOT-23 package. 100 kHz operation for voltages from 1.8V to 4.5V	P, SN, ST, OT
24LC00	1M	128 bits (x8)	4 ms	400 kHz	2.5V to 6.0V		P, SN, ST, OT
24AA00	1M	128 bits (x8)	4 ms	400 kHz	1.8V to 6.0V		P, SN, ST, OT
24C01C	1M	1K bits (x8)	1 ms	400 kHz	4.5V to 5.5V	The 24C01C and 24C02C are for applications which require fast byte write and/or extended temperature. I ² C compatible. 3 address pins.	P, SN, ST
24C02C	1M	2K bits (x8)	1 ms	400 kHz	4.5V to 5.5V		P, SN, ST
24LC01B	1M	1K bits (x8)	10 ms	400 kHz	2.5V to 5.5V	Hardware write protect. Schmitt trigger inputs. 100 kHz operation @ extended temperatures. 5-pin SOT-23 package. 2.5V operation @ extended temperatures. 100 kHz operation for voltages from 1.8V to 2.5V	P, SN, ST, MS, OT
24LC02B	1M	2K bits (x8)	10 ms	400 kHz	2.5V to 5.5V		P, SN, ST, MS, OT
24LC04B	1M	4K bits (x8)	10 ms	400 kHz	2.5V to 5.5V		P, SN, ST, MS, OT
24LC08B	1M	8K bits (x8)	10 ms	400 kHz	2.5V to 5.5V		P, SN, ST, MS, OT
24LC16B	1M	16K bits (x8)	10 ms	400 kHz	2.5V to 5.5V		P, SN, ST, MS, OT
24AA01	1M	1K bits (x8)	10 ms	400 kHz	1.8V to 5.5V	Hardware write protect. Schmitt trigger inputs. 100 kHz operation for voltages from 1.8V to 2.5V.	P, SN
24AA02	1M	2K bits (x8)	10 ms	400 kHz	1.8V to 5.5V		P, SN, ST, MS, OT
24AA04	1M	4K bits (x8)	10 ms	400 kHz	1.8V to 5.5V		P, SN, ST, MS, OT
24AA08	1M	8K bits (x8)	10 ms	400 kHz	1.8V to 5.5V		P, SN, ST, MS, OT
24AA16	1M	16K bits (x8)	10 ms	400 kHz	1.8V to 5.5V		P, SN, ST, MS, OT
24LC32A	1M	32K bits (x8)	5 ms	400 kHz	2.5V to 5.5V	Industry standard addressable 32K bit I ² C Serial EEPROM. 100 kHz operation for voltages from 1.8V to 2.5V.	P, SN, SM, ST, MS
24AA32A	1M	32K bits (x8)	5 ms	400 kHz	1.8V to 5.5V		P, SN, SM, ST, MS
24LC64	1M	64K bits (x8)	5 ms	400 kHz	2.5V to 5.5V	32 byte page. 100 KHz operation for voltages from 1.8V to 2.5V.	P, SN, SM, ST, MS
24AA64	1M	64K bits (x8)	10 ms	400 kHz	1.8V to 5.5V		P, SN, SM, ST, MS

SERIAL ELECTRICALLY ERASABLE PROMs (EEPROM)

Product	E/W Cycles	Density (Organization)	Write Speed	Max. Clock Freq.	Operating Voltage	Unique Features	Packages	
2-Wire I²C Serial EEPROM Family** (continued)								
24LC65	1 M/10 M	64K bits (x8)	5 ms	400 kHz	2.5V to 5.5V	8 byte page, 64 byte input buffer, high endurance block, write protectable in 4K blocks	P, SM	
24AA65	1 M/10 M	64K bits (x8)	5 ms	400 kHz	1.8V to 5.5V		P, SM	
24C65	1 M/10 M	64K bits (x8)	5 ms	400 kHz	4.5V to 5.5V		P, SM	
24LC128	1M	128K bits (x8)	5 ms	400 kHz	2.5V to 5.5V	64 byte page. 100 kHz operation for voltages from 1.8V to 2.5V.	P, SN, SM, ST14, ST	
24AA128	1M	128K bits (x8)	10 ms	400 kHz	1.8V to 5.5V		P, SN, SM, ST14, ST	
24LC256	1M	256K bits (x8)	5 ms	400 kHz	2.5V to 5.5V	64 byte page. 100 kHz operation for voltages from 1.8V to 2.5V.	P, SM, SN, ST	
24AA256	1M	256K bits (x8)	10 ms	400 kHz	1.8V to 5.5V		P, SM, SN, ST	
24LC515	1M	512 Kbits (x8)	5 ms	400 kHz	2.5V to 5.5V	Cascadeable up to 4 devices (2M bits) 100 kHz operation for voltages from 1.8V to 2.5V	P, SM	
24AA515	1M	512 Kbits (x8)	5 ms	400 kHz	2.5V to 5.5V		P, SM	
24FC128	1M	128K bits (x8)	5 ms	1 MHz	2.5V to 5.5V	400 kHz operation for voltages below 4.5V 400 kHz operation for voltages below 4.5V	P, SN, SM	
24FC256	1M	256K bits (x8)	5 ms	1 MHz	2.5V to 5.5V		P, SN, SM	
ISO Smart Card Family								
24C01SC	1M	1K bits (x8)	10 ms	400 kHz	2.5V to 5.5V	Smart card specific memory devices. All devices meet ISO7816 pinout requirements.	S, W, WF	
24C02SC	1M	2K bits (x8)	10 ms	400 kHz	2.5V to 5.5V		S, W, WF	
24LC16SC	1M	16K bits (x8)	10 ms	400 kHz	2.5V to 5.5V		S, W, WF	
24LC32ASC	1M	32K bits (x8)	5 ms	400 kHz	2.5V to 5.5V		S, W, WF	
24LC64SC	1M	64K bits (x8)	5 ms	400 kHz	2.5V to 5.5V		S, W, WF	
24LC128SC	1M	128K bits (x8)	5 ms	400 kHz	2.5V to 5.5V		S, W, WF	
24LC256SC	1M	256K bits (x8)	5 ms	400 kHz	2.5V to 5.5V		S, W, WF	
**The B version on the 2-wire (I²C) devices designates: no functional address (A0, A1, A2) pins, 400 kHz operation, Schmitt trigger inputs for greater noise protection, longer byte write cycle time and larger input buffer.								
Special Features: Self-timed write cycle and page write mode.								
SPI™ Serial EEPROM Family								
25C040	1M	4K bits (x8)	5 ms	3 MHz	4.5V to 5.5V	Supports SPI Modes 0, 3.	P, SN, ST	
25C080	1M	8K bits (x8)	5 ms	3 MHz	4.5V to 5.5V		P, SN	
25C160	1M	16K bits (x8)	5 ms	3 MHz	4.5V to 5.5V		P, SN	
25C320	1M	32K bits (x8)	5 ms	3 MHz	4.5V to 5.5V		P, SN, ST14	
25LC040	1M	4K bits (x8)	5 ms	2 MHz	2.5V to 5.5V	Supports SPI Modes 0, 3.	P, SN, ST	
25LC080	1M	8K bits (x8)	5 ms	2 MHz	2.5V to 5.5V		P, SN	
25LC160	1M	16K bits (x8)	5 ms	2 MHz	2.5V to 5.5V		P, SN	
25LC320	1M	32K bits (x8)	5 ms	2 MHz	2.5V to 5.5V	Supports SPI Modes 0, 3. Supports 2.5V operation @ extended temperatures.	P, SN, ST14, ST	
25LC640	1M	64K bits (x8)	5 ms	2 MHz	2.5V to 5.5V		P, SN, ST	
25AA040	1M	4K bits (x8)	5 ms	1 MHz	1.8V to 5.5V	Supports SPI Modes 0, 3.	P, SN, ST	
25AA080	1M	8K bits (x8)	5 ms	1 MHz	1.8V to 5.5V		P, SN	
25AA160	1M	16K bits (x8)	5 ms	1 MHz	1.8V to 5.5V		P, SN	
25AA320	1M	32K bits (x8)	5 ms	1 MHz	1.8V to 5.5V		P, SN, SM, ST	
25AA640	1M	64K bits (x8)	5 ms	1 MHz	1.8V to 5.5V		P, SN, SM, ST	
Special Features: Page write mode, HOLD pin, software enabled block write protection and hardware write protect pin.								
*Contact Microchip Technology Inc. for availability.								
Identification Products (Application-Specific Products for Monitors, DRAM Modules, ACR Risers and Other Plug-And-Play Applications)								
24ACR01	1M	1K bits (x8)	10 ms	400 kHz	2.5V to 5.5V	ACR Riser card ID, 1011 address	P, SN	
24ACR02	1M	2K bits (x8)	10 ms	400 kHz	2.5V to 5.5V	ACR Riser card ID, 1011 address	P, SN	
24LC09	1M	8K bits (x8)	10 ms	400 kHz	2.5V to 5.5V	ACR Riser card ID, 1011 address	P, SN	
24LC21	1M	1K bits (x8)	10 ms	400 kHz	2.5V to 5.5V	Completely implements DDC1™/DDC2™ interface for VESA monitor identification. Improved noise filter. Software enabled Hardware Write Protection pin.	P, SN	
24LCS21	1M	1K bits (x8)	10 ms	400 kHz	2.5V to 5.5V		P, SN	
24LC21A	1M	1K bits (x8)	10 ms	400 kHz	2.5V to 5.5V	Same as 24LC21 plus "return to DDC1" feature. Same as 24LCS21 plus "return to DDC1" feature.	P, SN	
24LCS21A	1M	1K bits (x8)	10 ms	400 kHz	2.5V to 5.5V		P, SN	
24LC024	1M	2K bits (x8)	10 ms	400 kHz	2.5V to 5.5V	Addressable, hardware write protection for DRAM DIMM modules. Addressable, no WP. Addressable, software write protection for DRAM DIMM modules.	P, SN, ST, MS	
24LC025	1M	2K bits (x8)	10 ms	400 kHz	2.5V to 5.5V		P, SN, ST, MS	
24LCS52	1M	2K bits (x8)	10 ms	400 kHz	2.5V to 5.5V		P, SN, ST, MS	
24LCS61	1M	1K bits (x8)	10 ms	400 kHz	2.5V to 5.5V	Software addressable devices for board identification, software WP.	P, SN, ST	
24LCS62	1M	2K bits (x8)	10 ms	400 kHz	2.5V to 5.5V	Software addressable devices for board identification, software WP.	P, SN, ST	

DEVELOPMENT SYSTEMS

MPLAB[®] ICE Emulator Systems and PRO MATE[®] II Programmer Socket Modules

MPLAB ICE 2000 Emulator System

How Do I Order MPLAB ICE?

Ordering MPLAB ICE is as easy as 1, 2, and 3!

1. Choose your PICmicro MCU.
2. Choose your PICmicro package.
3. Find the right line on the next few pages for MPLAB ICE part numbers. You're ready to order.

A COMPLETE MPLAB ICE SYSTEM

MPLAB ICE is a modular emulator system with interchangeable components allowing the system to be easily configured to emulate different PICmicro MCUs. Since this emulator supports package-specific emulation, customers need to know which device and package they intend to emulate. Then, the customer can use the *MPLAB ICE Cross Reference Parts List* below to identify the part numbers required to complete an MPLAB ICE system. A complete system consists of:

1. An emulator pod (including among other things the host-to-pod parallel cable and power supply)
2. A processor module (including the flex cable circuit)
3. A device adapter
4. An optional transition socket

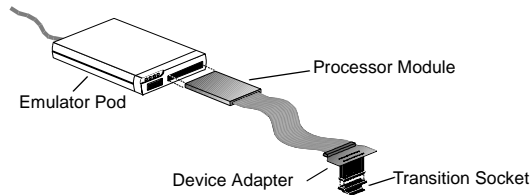

An MPLAB ICE emulator system is ordered as separate components. Knowing the terms will make it easy to order and use the MPLAB ICE emulator system. Read more about each component.

1. Emulator Pod

The MPLAB ICE 2000 is the full-featured emulator pod containing a main board and an additional board for expanded trace memory and complex control logic. The pod comes with a standard parallel interface cable that connects the pod to the parallel port of the PC and a power supply.

2. Processor Module

The processor module is a PICmicro, device-specific module that is inserted into the emulator pod. The processor module contains the emulator chip, logic, and low-voltage circuitry. A flex cable extends from the processor module and is connected to the device adapter at the target application.

3. Device Adapter

The device adapter provides a common interface for the PICmicro MCU being emulated. This adapter contains a special device that provides an oscillator clock allowing the user to accurately emulate the RC characteristics of the PICmicro MCU. The device adapter provides emulation support for standard DIP and PLCC styles. For emulation support of other packages, a transition socket is needed along with the device adapter.

4. Transition Socket

The transition sockets are available in various styles to allow the common device adapter to be translated to support surface-mount packages, such as SOIC, SSOP, PQFP, and TQFP.

PRO MATE[®] II Programmer

The PRO MATE II Programmer (DV007003) is Microchip's production rated programmer which can be operated stand alone or with a PC using MPLAB IDE (included free). It comes complete with accessories needed to connect to a host system including a power supply and cables, and it gives the developer complete control over the programming session. Each PRO MATE II Programmer requires a socket module (to be purchased separately) which can be selected from the following chart by identifying the devices for programming and then picking the appropriate part number from the PRO MATE II Programmer Socket Modules column.

In-Circuit Serial Programming™ (ICSP™) can also be added to the PRO MATE II Programmer by ordering Socket Module AC004004.

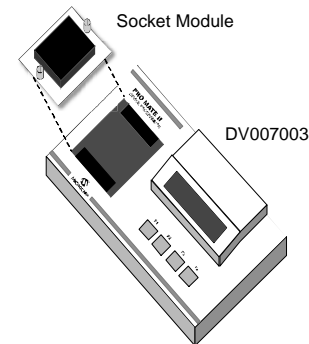

DEVELOPMENT SYSTEMS

MPLAB® ICE Emulator Systems and PRO MATE® II Programmer Socket Modules

Model Name/ Part Number	Lead Count/ Package Type	Emulator Pod	Processor Module	Device Adapters	Transition Sockets	PRO MATE II Programmer (DV007003) Socket Modules ⁽¹⁾	Model Name/ Part Number	Lead Count/ Package Type	Emulator Pod	Processor Module	Device Adapters	Transition Sockets	PRO MATE II Programmer (DV007003) Socket Modules ⁽¹⁾
MCP250XX	14P, 14SO	N/A	N/A	N/A	N/A	AC254001							
PIC12C508	8P, 8JW 8SM	ICE2000 ICE2000	PCM16XA0 PCM16XA0	DVA12XP080 DVA12XP080	– XLT08SO	AC124001 AC124001	PIC16C62B	28SP, 28JW 28ML 28SO 28SS	ICE2000 ICE2000 ICE2000 ICE2000	PCM16XE1 PCM16XE1 PCM16XE1 PCM16XE1	DVA16XP282 DVA16XP282 DVA16XP282 DVA16XP282	– TBD XLT28SO XLT28SS	AC164012 See Note 2 AC164017 AC164021
PIC12C508A	8P, 8JW 8SM 8SN	ICE2000 ICE2000 ICE2000	PCM16XA0 PCM16XA0 PCM16XA0	DVA12XP080 DVA12XP080 DVA12XP080	– XLT08SO XLT08SO	AC124001 AC124001 AC164026	PIC16C63	28SP, 28JW 28SO	ICE2000 ICE2000	PCM16XB1 PCM16XB1	DVA16XP282 DVA16XP282	– XLT28SO	AC164012 AC164017
PIC12C509	8P, 8JW 8SM	ICE2000 ICE2000	PCM16XA0 PCM16XA0	DVA12XP080 DVA12XP080	– XLT08SO	AC124001 AC124001	PIC16C63A	28SP, 28JW 28ML 28SO 28SS	ICE2000 ICE2000 ICE2000 ICE2000	PCM16XE1 PCM16XE1 PCM16XE1 PCM16XE1	DVA16XP282 DVA16XP282 DVA16XP282 DVA16XP282	– TBD XLT28SO XLT28SS	AC164012 See Note 2 AC164017 AC164021
PIC12C509A	8P, 8JW 8SM 8SN	ICE2000 ICE2000 ICE2000	PCM16XA0 PCM16XA0 PCM16XA0	DVA12XP080 DVA12XP080 DVA12XP080	– XLT08SO XLT08SO	AC124001 AC124001 AC164026	PIC16C64A	40P, 40JW 44L 44PQ 44PT	ICE2000 ICE2000 ICE2000 ICE2000	PCM16XB1 PCM16XB1 PCM16XB1 PCM16XB1	DVA16XP401 DVA16XL441 DVA16PQ441 DVA16PQ441	– – XLT44PT XLT44PT	AC164012 AC164013 AC164014 AC164020
PIC12C671	8P, 8JW 8SM	ICE2000 ICE2000	PCM12XA0 PCM12XA0	DVA12XP081 DVA12XP081	– XLT08SO	AC124001 AC124001	PIC16C65A	40P, 40JW 44L 44PQ 44PT	ICE2000 ICE2000 ICE2000 ICE2000	PCM16XB1 PCM16XB1 PCM16XB1 PCM16XB1	DVA16XP401 DVA16XL441 DVA16PQ441 DVA16PQ441	– – XLT44PT XLT44PT	AC164012 AC164013 AC164014 AC164020
PIC12C672	8P, 8JW 8SM	ICE2000 ICE2000	PCM12XA0 PCM12XA0	DVA12XP081 DVA12XP081	– XLT08SO	AC124001 AC124001	PIC16C65B	40P, 40JW 44L 44PQ 44PT	ICE2000 ICE2000 ICE2000 ICE2000	PCM16XE1 PCM16XE1 PCM16XE1 PCM16XE1	DVA16XP400 DVA16XL441 DVA16PQ441 DVA16PQ441	– – XLT44PT XLT44PT	AC164012 AC164013 AC164014 AC164020
PIC12CE518	8P, 8JW 8SM 8SN	ICE2000 ICE2000 ICE2000	PCM16XA0 PCM16XA0 PCM16XA0	DVA12XP080 DVA12XP080 DVA12XP080	– XLT08SO XLT08SO	AC124001 AC124001 AC164026	PIC16C66	28SP, 28JW 28SO	ICE2000 ICE2000	PCM16XE1 PCM16XE1	DVA16XP282 DVA16XP282	– XLT28SO	AC164012 AC164017
PIC12CE519	8P, 8JW 8SM 8SN	ICE2000 ICE2000 ICE2000	PCM16XA0 PCM16XA0 PCM16XA0	DVA12XP080 DVA12XP080 DVA12XP080	– XLT08SO XLT08SO	AC124001 AC124001 AC164026	PIC16C67	40P, 40JW 44L 44PQ 44PT	ICE2000 ICE2000 ICE2000 ICE2000	PCM16XE1 PCM16XE1 PCM16XE1 PCM16XE1	DVA16XP401 DVA16XL441 DVA16PQ441 DVA16PQ441	– – XLT44PT XLT44PT	AC164012 AC164013 AC164014 AC164020
PIC12CE673	8P, 8JW	ICE2000	PCM12XA0	DVA12XP081	–	AC124001	PIC16C71	18P, 18JW 18SO	ICE2000 ICE2000	PCM16XF0 PCM16XF0	DVA16XP180 DVA16XP180	– XLT18SO	AC164010 AC164010
PIC12CE674	8P, 8JW	ICE2000	PCM12XA0	DVA12XP081	–	AC124001	PIC16C72	28SP, 28JW 28SO 28SS	ICE2000 ICE2000 ICE2000	PCM16XB1 PCM16XB1 PCM16XB1	DVA16XP282 DVA16XP282 DVA16XP282	– XLT28SO XLT28SS	AC164012 AC164017 AC164021
PIC14000	28SP, 28JW 28SO 28SS	ICE2000 ICE2000 ICE2000	PCM14XA0 PCM14XA0 PCM14XA0	DVA14XP280 DVA14XP280 DVA14XP280	– XLT28SO XLT28SS	AC144001 AC144002 AC144002	PIC16C72A	28SP, 28JW 28ML 28SO 28SS	ICE2000 ICE2000 ICE2000 ICE2000	PCM16XE1 PCM16XE1 PCM16XE1 PCM16XE1	DVA16XP282 DVA26XP282 DVA16XP282 DVA16XP282	– TBD XLT28SO XLT28SS	AC164012 See Note 2 AC164017 AC164021
PIC16C52	18P 18SO	ICE2000 ICE2000	PCM16XA0 PCM16XA0	DVA16XP180 DVA16XP180	– XLT18SO	AC164001 AC164002	PIC16C73A	28SP, 28JW 28SO	ICE2000 ICE2000	PCM16XB1 PCM16XB1	DVA16XP282 DVA16XP282	– XLT28SO	AC164012 AC164017
PIC16C54/ PIC16C54A/ PIC16C54C	18P, 18JW 18SO 20SS	ICE2000 ICE2000 ICE2000	PCM16XA0 PCM16XA0 PCM16XA0	DVA16XP180 DVA16XP180 DVA16XP180	– XLT18SO XLT20SS	AC164001 AC164002 AC164015	PIC16C73B	28SP, 28JW 28ML 28SO 28SS	ICE2000 ICE2000 ICE2000 ICE2000	PCM16XE1 PCM16XE1 PCM16XE1 PCM16XE1	DVA16XP282 DVA16XP282 DVA16XP282 DVA16XP282	– TBD XLT28SO XLT28SS	AC164012 See Note 2 AC164017 AC164021
PIC16C55/ PIC16C55A	28P, 28JW 28SP 28SO 28SS	ICE2000 ICE2000 ICE2000 ICE2000	PCM16XA0 PCM16XA0 PCM16XA0 PCM16XA0	DVA16XP280 DVA16XP280 DVA16XP280 DVA16XP280	XLT28XP – XLT28SO XLT28SS2	AC164001 AC164001 AC164002 AC164015	PIC16C74A	40P, 40JW 44L 44PQ 44PT	ICE2000 ICE2000 ICE2000 ICE2000	PCM16XB1 PCM16XB1 PCM16XB1 PCM16XB1	DVA16XP401 DVA16XL441 DVA16PQ441 DVA16PQ441	– – XLT44PT XLT44PT	AC164012 AC164013 AC164014 AC164020
PIC16C56/ PIC16C56A	18P, 18JW 18SO 20SS	ICE2000 ICE2000 ICE2000	PCM16XA0 PCM16XA0 PCM16XA0	DVA16XP180 DVA16XP180 DVA16XP180	– XLT18SO XLT20SS	AC164001 AC164002 AC164015	PIC16C74B	40P, 40JW 44L 44PQ 44PT	ICE2000 ICE2000 ICE2000 ICE2000	PCM16XE1 PCM16XE1 PCM16XE1 PCM16XE1	DVA16XP401 DVA16XL441 DVA16PQ441 DVA16PQ441	– – XLT44PT XLT44PT	AC164012 AC164013 AC164014 AC164020
PIC16C57/ PIC16C57C	28P, 28JW 28SP 28SO 28SS	ICE2000 ICE2000 ICE2000 ICE2000	PCM16XA0 PCM16XA0 PCM16XA0 PCM16XA0	DVA16XP280 DVA16XP280 DVA16XP280 DVA16XP280	XLT28XP – XLT28SO XLT28SS2	AC164001 AC164001 AC164002 AC164015							
PIC16C58A/ PIC16C58B	18P, 18JW 18SO 20SS	ICE2000 ICE2000 ICE2000	PCM16XA0 PCM16XA0 PCM16XA0	DVA16XP180 DVA16XP180 DVA16XP180	– XLT18SO XLT20SS	AC164001 AC164002 AC164015							
PIC16C62A	28SP, 28JW 28SO 28SS	ICE2000 ICE2000 ICE2000	PCM16XB1 PCM16XB1 PCM16XB1	DVA16XP282 DVA16XP282 DVA16XP282	– XLT28SO XLT28SS	AC164012 AC164017 AC164021							

Model Name/ Part Number	Lead Count/ Package Type	Emulator Pod	Processor Module	Device Adapters	Transition Sockets	PRO MATE II Programmer (DV007003) Socket Modules ⁽¹⁾
PIC16C76	28SP, 28JW 28SO	ICE2000 ICE2000	PCM16XE1 PCM16XE1	DVA16XP282 DVA16XP282	– XLT28SO	AC164012 AC164017
PIC16C77	40P, 40JW 44L 44PQ 44PT	ICE2000 ICE2000 ICE2000 ICE2000	PCM16XE1 PCM16XE1 PCM16XE1 PCM16XE1	DVA16XP401 DVA16XL441 DVA16PQ441 DVA16PQ441	– – XLT44PT XLT44PT	AC164012 AC164013 AC164014 AC164020
PIC16C432	20P, 20JW 20SS	ICE2000 ICE2000	PCM16YB0* PCM16YB0*	DVA16XP201* DVA16XP201*	– XLT20SS1	AC164029 AC164029
PIC16C433	18P, 18JW 18SS	ICE2000 ICE2000	PCM16YC0* PCM16YC0*	DVA16XP185* DVA16XP185*	– XLT18SO	AC164030 AC164030
PIC16C505	14P, 14JW 14SL	ICE2000 ICE2000	PCM16XA0 PCM16XA0	DVA16XP140 DVA16XP140	– XLT14SO	AC124001 AC164026
PIC16C554	18P, 18JW 18SO 18SS	ICE2000 ICE2000 ICE2000	PCM16XC0 PCM16XC0 PCM16XC0	DVA16XP180 DVA16XP180 DVA16XP180	– XLT18SO XLT20SS	AC164010 AC164010 AC164018
PIC16C558	18P, 18JW 18SO 20SS	ICE2000 ICE2000 ICE2000	PCM16XC0 PCM16XC0 PCM16XC0	DVA16XP180 DVA16XP180 DVA16XP180	– XLT18SO XLT20SS	AC164010 AC164010 AC164018
PIC16C620/ PIC16C620A	18P, 18JW 18SO 20SS	ICE2000 ICE2000 ICE2000	PCM16XC0 PCM16XC0 PCM16XC0	DVA16XP180 DVA16XP180 DVA16XP180	– XLT18SO XLT20SS	AC164010 AC164010 AC164018
PIC16C621/ PIC16C621A	18P, 18JW 18SO 20SS	ICE2000 ICE2000 ICE2000	PCM16XC0 PCM16XC0 PCM16XC0	DVA16XP180 DVA16XP180 DVA16XP180	– XLT18SO XLT20SS	AC164010 AC164010 AC164018
PIC16C622/ PIC16C622A	18P, 18JW 18SO 20SS	ICE2000 ICE2000 ICE2000	PCM16XC0 PCM16XC0 PCM16XC0	DVA16XP180 DVA16XP180 DVA16XP180	– XLT18SO XLT20SS	AC164010 AC164010 AC164018
PIC16C642	28SP, 28JW 28SO	ICE2000 ICE2000	PCM16XD0 PCM16XD0	DVA16XP282 DVA16XP282	– XLT28SO	AC164012 AC164017
PIC16C662	40P, 40JW 44L 44PQ 44PT	ICE2000 ICE2000 ICE2000 ICE2000	PCM16XD0 PCM16XD0 PCM16XD0 PCM16XD0	DVA16XP401 DVA16XL441 DVA16PQ441 DVA16PQ441	– – XLT44PT XLT44PT	AC164012 AC164013 AC164014 AC164020
PIC16C710	18P, 18JW 18SO 20SS	ICE2000 ICE2000 ICE2000	PCM16XF0 PCM16XF0 PCM16XF0	DVA16XP180 DVA16XP180 DVA16XP180	– XLT18SO XLT20SS	AC164010 AC164010 AC164018
PIC16C711	18P, 18JW 18SO 20SS	ICE2000 ICE2000 ICE2000	PCM16XF0 PCM16XF0 PCM16XF0	DVA16XP180 DVA16XP180 DVA16XP180	– XLT18SO XLT20SS	AC164010 AC164010 AC164018
PIC16C712	18P, 18JW 18SO 20SS	ICE2000 ICE2000 ICE2000	PCM16XE1 PCM16XE1 PCM16XE1	DVA16XP182 DVA16XP182 DVA16XP182	– XLT18SO XLT20SS	AC164010 AC164010 AC164018
PIC16C715	18P, 18JW 18SO 20SS	ICE2000 ICE2000 ICE2000	PCM16XG0 PCM16XG0 PCM16XG0	DVA16XP180 DVA16XP180 DVA16XP180	– XLT18SO XLT20SS	AC164010 AC164010 AC164018
PIC16C716	18P, 18JW 18SO 20SS	ICE2000 ICE2000 ICE2000	PCM16XE1 PCM16XE1 PCM16XE1	DVA16XP182 DVA16XP182 DVA16XP182	– XLT18SO XLT20SS	AC164010 AC164010 AC164018
PIC16C717	18P, 18JW 18SO 20SS	ICE2000 ICE2000 ICE2000	PCM16XN1 PCM16XN1 PCM16XN1	DVA16XP184 DVA16XP184 DVA16XP184	– XLT18SO XLT20SS	AC164010 AC164010 AC164018
PIC16C745	28SP, 28JW 28SO	ICE2000 ICE2000	PCM16XQ0 PCM16XQ0	DVA16XP282 DVA16XP282	– XLT28SO	AC164012 AC164017
PIC16C765	40P 44L 44PT	ICE2000 ICE2000 ICE2000	PCM16XQ0 PCM16XQ0 PCM16XQ0	DVA16XP401 DVA16XL441 DVA16PQ441	– – XLT44PT	AC164012 AC164013 AC164020

Model Name/ Part Number	Lead Count/ Package Type	Emulator Pod	Processor Module	Device Adapters	Transition Sockets	PRO MATE II Programmer (DV007003) Socket Modules ⁽¹⁾
PIC16C770 PIC16C771	20P 20SO 20SS	ICE2000 ICE2000 ICE2000	PCM16XN1 PCM16XN1 PCM16XN1	DVA16XP200 DVA16XP200 DVA16XP200	– XLT20SO1 XLT20SS1	AC164028 AC164028 AC164018
PIC16C773	28SP, 28JW 28SO 28SS	ICE2000 ICE2000 ICE2000	PCM16XL0 PCM16XL0 PCM16XL0	DVA16XP282 DVA16XP282 DVA16XP282	– XLT28SO XLT28SS	AC164012 AC164017 AC164021
PIC16C774	40P, 40JW 44L 44PQ 44PT	ICE2000 ICE2000 ICE2000 ICE2000	PCM16XL0 PCM16XL0 PCM16XL0 PCM16XL0	DVA16XP401 DVA16XL441 DVA16PQ441 DVA16PQ441	– – XLT44PT XLT44PT	AC164012 AC164013 AC164014 AC164020
PIC16C781	20P, 20JW 20SO 20SS	ICE2000 ICE2000 ICE2000	PCM16XW0 PCM16XW0 PCM16XW0	DVA16XP202 DVA16XP202 DVA16XP202	– XLT20SO1 XLT20SO1	AC164028 AC164028 AC164018
PIC16782	20P, 20JW 20SO 20SS	ICE2000 ICE2000 ICE2000	PCM16XW0 PCM16XW0 PCM16XW0	DVA16XP202 DVA16XP202 DVA16XP202	– XLT20SO1 XLT20SO1	AC164028 AC164028 AC164018
PIC16C923 PIC16C924	64SP 64PT 68L, 68CL	ICE2000 ICE2000 ICE2000	PCM16XJ0 PCM16XJ0 PCM16XJ0	DVA16XP640 DVA16PQ640 DVA16XL680	– XLT64PT1 –	AC164025 AC164023 AC164022
PIC16C925 PIC16C926	64PT, 68L	ICE2000 ICE2000	PCM16XT0 PCM16XT0	DVA16PQ640 DVA16XL680	XLT64PT1 –	AC164023 AC164022
PIC16CE623	18P, 18JW 18SO 20SS	ICE2000 ICE2000 ICE2000	PCM16XC0 PCM16XC0 PCM16XC0	DVA16XP180 DVA16XP180 DVA16XP180	– XLT18SO XLT20SS	AC164010 AC164010 AC164018
PIC16CE624	18P, 18JW 18SO 20SS	ICE2000 ICE2000 ICE2000	PCM16XC0 PCM16XC0 PCM16XC0	DVA16XP180 DVA16XP180 DVA16XP180	– XLT18SO XLT20SS	AC164010 AC164010 AC164018
PIC16CE625	18P, 18JW 18SO 20SS	ICE2000 ICE2000 ICE2000	PCM16XC0 PCM16XC0 PCM16XC0	DVA16XP180 DVA16XP180 DVA16XP180	– XLT18SO XLT20SS	AC164010 AC164010 AC164018
PIC16F73	28SP 28ML 28SS 28SO	ICE2000 ICE2000 ICE2000 ICE2000	PCM16XS1 PCM16XS1 PCM16XS1 PCM16XS1	DVA16XP282 DVA16XP282 DVA16XP282 DVA16XP282	– TBD XLT28SS XLT28SO	AC164012 See Note 2 AC164021 AC164017
PIC16F74	40P 44L 44PT	ICE2000 ICE2000 ICE2000	PCM16XS1 PCM16XS1 PCM16XS1	DVA16XP401 DVA16XL441 DVA16PQ441	– – XLT44PT	AC164012 AC164013 AC164020
PIC16F76	28SP, 28JW 28ML 28SO	ICE2000 ICE2000 ICE2000	PCM16XS1 PCM16XS1 PCM16XS1	DVA16XP282 DVA16XP282 DVA16XP282	– TBD XLT28SO	AC164012 See Note 2 AC164017
PIC16F77	40P, 40JW 44L 44PQ 44PT	ICE2000 ICE2000 ICE2000 ICE2000	PCM16XS1 PCM16XS1 PCM16XS1 PCM16XS1	DVA16XP401 DVA16XL441 DVA16PQ441 DVA16PQ441	– – XLT44PT XLT44PT	AC164012 AC164013 AC164014 AC164020
PIC16F83	18P 18SO	ICE2000 ICE2000	PCM16XH1 PCM16XH1	DVA16XP180 DVA16XP180	– XLT18SO	AC164010 AC164010
PIC16F84	18P 18SO	ICE2000 ICE2000	PCM16XH1 PCM16XH1	DVA16XP180 DVA16XP180	– XLT18SO	AC164010 AC164010
PIC16F84A	18P 18SO 20SS	ICE2000 ICE2000 ICE2000	PCM16XH1 PCM16XH1 PCM16XH1	DVA16XP180 DVA16XP180 DVA16XP180	– XLT18SO XLT20SS	AC164010 AC164010 AC164018
PIC16F627	18P, 18JW 18SO 20SS	ICE2000 ICE2000 ICE2000	PCM16XP0 PCM16XP0 PCM16XP0	DVA16XP183 DVA16XP183 DVA16XP183	– XLT18SO XLT20SS	AC164010 AC164010 AC164018
PIC16F628	18P, 18JW 18SO 20SS	ICE2000 ICE2000 ICE2000	PCM16XP0 PCM16XP0 PCM16XP0	DVA16XP183 DVA16XP183 DVA16XP183	– XLT18SO XLT20SS	AC164010 AC164010 AC164018

Model Name/ Part Number	Lead Count/ Package Type	Emulator Pod	Processor Module	Device Adapters	Transition Sockets	PRO MATE II Programmer (DV007003) Socket Modules ⁽¹⁾
PIC16F870	28SP, 28JW 28SO 28SS	ICE2000 ICE2000 ICE2000	PCM16XR0 PCM16XR0 PCM16XR0	DVA16XP282 DVA16XP282 DVA16XP282	– XLT28SO XLT28SS	AC164012 AC164017 AC164021
PIC16F871	40P 44L 44PT	ICE2000 ICE2000 ICE2000	PCM16XR0 PCM16XR0 PCM16XR0	DVA16XP401 DVA16XL441 DVA16PQ441	– – XLT44PT	AC164012 AC164013 AC164020
PIC16F872	28SP 28SO 28SS	ICE2000 ICE2000 ICE2000	PCM16XK1 PCM16XK1 PCM16XK1	DVA16XP282 DVA16XP282 DVA16XP282	– XLT28SO XLT28SS	AC164012 AC164017 AC164021
PIC16F873	28SP 28SO	ICE2000 ICE2000	PCM16XK1 PCM16XK1	DVA16XP282 DVA16XP282	– XLT28SO	AC164012 AC164017
PIC16F874	40P 44L 44PQ 44PT	ICE2000 ICE2000 ICE2000 ICE2000	PCM16XK1 PCM16XK1 PCM16XK1 PCM16XK1	DVA16XP401 DVA16XL441 DVA16PQ441 DVA16PQ441	– – XLT44PT XLT44PT	AC164012 AC164013 AC164014 AC164020
PIC16F876	28SP 28SO	ICE2000 ICE2000	PCM16XK1 PCM16XK1	DVA16XP282 DVA16XP282	– XLT28SO	AC164012 AC164017
PIC16F877	40P 44L 44PQ 44PT	ICE2000 ICE2000 ICE2000 ICE2000	PCM16XK1 PCM16XK1 PCM16XK1 PCM16XK1	DVA16XP401 DVA16XL441 DVA16PQ441 DVA16PQ441	– – XLT44PT XLT44PT	AC164012 AC164013 AC164014 AC164020
PIC16HV540	18P 18SO 18SS	– – –	– – –	– – –	– – –	AC164001 AC164002 AC164015
PIC17C42A	40P, 40JW 44L 44PQ 44PT	ICE2000 ICE2000 ICE2000 ICE2000	PCM17XA0 PCM17XA0 PCM17XA0 PCM17XA0	DVA17XP401 DVA17XL441 DVA17PQ441 DVA17PQ441	– – XLT44PT XLT44PT	AC174001 AC174002 AC174004 AC174005
PIC17C43	40P, 40JW 44L 44PQ 44PT	ICE2000 ICE2000 ICE2000 ICE2000	PCM17XA0 PCM17XA0 PCM17XA0 PCM17XA0	DVA17XP401 DVA17XL441 DVA17PQ441 DVA17PQ441	– – XLT44PT XLT44PT	AC174001 AC174002 AC174004 AC174005
PIC17C44	40P, 40JW 44L 44PQ 44PT	ICE2000 ICE2000 ICE2000 ICE2000	PCM17XA0 PCM17XA0 PCM17XA0 PCM17XA0	DVA17XP401 DVA17XL441 DVA17PQ441 DVA17PQ441	– – XLT44PT XLT44PT	AC174001 AC174002 AC174004 AC174005
PIC17C752	68L 64PT	ICE2000 ICE2000	PCM17XA0 PCM17XA0	DVA17XL681 DVA17PQ641	– XLT64PT2	AC174007 AC174008
PIC17C756/ PIC17C756A	68L, 68CL 64PT	ICE2000 ICE2000	PCM17XA0 PCM17XA0	DVA17XL681 DVA17PQ641	– XLT64PT2	AC174007 AC174008
PIC17C762	84L 80PT	ICE2000 ICE2000	PCM17XA0 PCM17XA0	DVA17XL841 DVA17PQ801	– XLT80PT	AC174012 AC174011
PIC17C766	84L, 84CL 80PT	ICE2000 ICE2000	PCM17XA0 PCM17XA0	DVA17XL841 DVA17PQ801	– XLT80PT	AC174012 AC174011
PIC18C242	28SP, 28JW 28SO	ICE2000 ICE2000	PCM18XA0 PCM18XA0	DVA16XP282 DVA16XP282	– XLT28SO	AC164012 AC164017
PIC18C252	28SP, 28JW 28SO	ICE2000 ICE2000 ICE2000	PCM18XA0 PCM18XA0 PCM18XA0	DVA16XP282 DVA16XP282 DVA16XP282	– – XLT28XP XLT28SO	AC164012 AC164012 AC164012 AC164017

Model Name/ Part Number	Lead Count/ Package Type	Emulator Pod	Processor Module	Device Adapters	Transition Sockets	PRO MATE II Programmer (DV007003) Socket Modules ⁽¹⁾
PIC18C442	40P, 40JW 44L 44PT	ICE2000 ICE2000 ICE2000	PCM18XA0 PCM18XA0 PCM18XA0	DVA16XP401 DVA16XL441 DVA16PQ441	– – XLT44PT	AC164012 AC164013 AC164020
PIC18C452	40P, 40JW 44L 44PT	ICE2000 ICE2000 ICE2000	PCM18XA0 PCM18XA0 PCM18XA0	DVA16XP401 DVA16XL441 DVA16PQ441	– – XLT44PT	AC164012 AC164013 AC164020
PIC18C601	68L 64PT	ICE2000 ICE2000	PCM18XG0 PCM18XG0	DVA18XL680 DVA18PQ640	– XLT64PT2	AC174007 AC174008
PIC18C658	68L 64PT	ICE2000 ICE2000	PCM18XB0 PCM18XB0	DVA18XL680 DVA18PQ640	– XLT64PT2	AC174007 AC174008
PIC18C801	80PT 84L	ICE2000 ICE2000	PCM18XG0 PCM18XG0	DVA18PQ801 DVA18XL841	XLT80PT –	AC174011 AC174012
PIC18C858	84L 80PT	ICE2000 ICE2000	PCM18XB0 PCM18XB0	DVA18XL840 DVA18PQ800	– XLT80PT	AC174012 AC174011
PIC18F242	28SP 28SO	ICE2000 ICE2000	PCM18XC1 PCM18XC1	DVA16XP282 DVA16XP282	– XLT28SO	AC164012 AC164017
PIC18F248	28SP 28SO	ICE2000 ICE2000	PCM18XD1 PCM18XD1	DVA16XP282 DVA16XP282	– XLT28SO	AC164012 AC164017
PIC18F252	28SP 28SO	ICE2000 ICE2000	PCM18XC1 PCM18XC1	DVA16XP282 DVA16XP282	– XLT28SO	AC164012 AC164017
PIC18F258	28SP 28SO	ICE2000 ICE2000	PCM18XD1 PCM18XD1	DVA16XP282 DVA16XP282	– XLT28SO	AC164012 AC164017
PIC18F442	40P 44L 44PT	ICE2000 ICE2000 ICE2000	PCM18XC1 PCM18XC1 PCM18XC1	DVA16XP401 DVA16XL441 DVA16PQ441	– – XLT44PT	AC164012 AC164013 AC164020
PIC18F448	40P 44L 44PT	ICE2000 ICE2000 ICE2000	PCM18XD1 PCM18XD1 PCM18XD1	DVA16XP401 DVA16XL441 DVA16PQ441	– – XLT44PT	AC164012 AC164013 AC164020
PIC18F452	40P 44L 44PT	ICE2000 ICE2000 ICE2000	PCM18XC1 PCM18XC1 PCM18XC1	DVA16XP401 DVA16XL441 DVA16PQ441	– – XLT44PT	AC164012 AC164013 AC164020
PIC18F458	40P 44L 44PT	ICE2000 ICE2000 ICE2000	PCM18XD1 PCM18XD1 PCM18XD1	DVA16XP401 DVA16XL441 DVA16PQ441	– – XLT44PT	AC164012 AC164013 AC164020
PIC18F6620	64PT	ICE2000	PCM18XE1*	DVA18PQ640	XLT64PT2	AC174008
PIC18F6720	64PT	ICE2000	PCM18XE1*	DVA18PQ640	XLT64PT2	AC174008
PIC18F8620	80PT	ICE2000	PCM18XE1*	DVA18PQ800*	XLT80PT	AC174011
PIC18F8720	80PT	ICE2000	PCM18XE1*	DVA18PQ800*	XLT80PT	AC174011
rfPIC12C509	18SO 20SS	ICE2000 ICE2000	PCM16XA0 PCM16XA0	DVA12XP080 DVA12XP080	XLT18SO XLT20SS	AC124002 AC124002

*Contact Microchip Technology Inc. for availability.

NOTE 1: PRO MATE II Programmer (DV007003) sold separately.
2: Requires AC164012 with a AC164031.

DEVELOPMENT SYSTEMS

MPLAB® In-Circuit Debugger (ICD)

The **MPLAB ICD** uses the in-circuit debugging capability of selected microcontrollers available from Microchip. It utilizes the In-Circuit Serial Programming™ (ICSP™) to debug source code in the application. Operating under Microchip's MPLAB Integrated Development Environment (IDE), MPLAB ICD offers real-time code execution, in-circuit debugging, built-in programmer⁽²⁾ and 3.0 to 5.5 volt operating range. See the selection chart below for the microcontroller devices supported and the various debugger kits available.

Device	MPLAB ICD ⁽¹⁾	MPLAB ICD 2 ⁽²⁾
PIC16F870	X	
PIC16F871	X	
PIC16F872	X	
PIC16F873	X	
PIC16F874	X	
PIC16F876	X	
PIC16F877	X	
PIC18C601		X
PIC18C801		X
PIC18F242		X
PIC18F248		X
PIC18F258		X
PIC18F442		X
PIC18F448		X
PIC18F452		X
PIC18F458		X
PIC18F6620		X
PIC18F6720		X
PIC18F8620		X
PIC18F8720		X

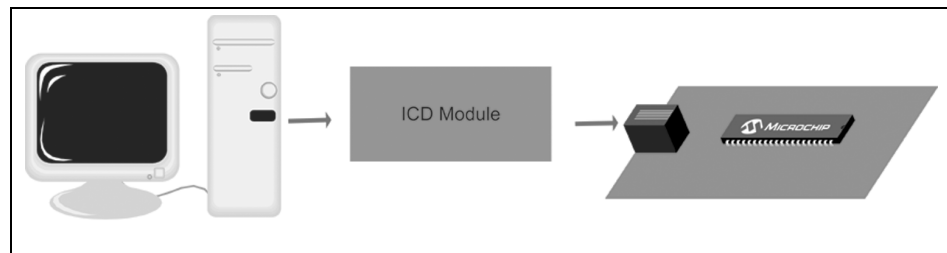

Part Number	Description of Debugger Kits
DV164001 (1)	MPLAB In-Circuit Debugger Evaluation Kit includes ICD Module, ICD Demo Board, ICD Header, ICD Cable, and Serial Cable.
DV164002(1)	MPLAB In-Circuit Debugger Module includes ICD Module and ICD Cable.
DV164003(1)	MPLAB In-Circuit Debugger Deluxe Evaluation Kit includes ICD Module, ICD Demo Board, ICD Header, ICD Cable, Serial Cable and Power Supply.
DV164005(2)*	MPLAB In-Circuit Debugger 2 Module includes ICD 2 Module, USB Cable and ICD Cable.
DV164006(2)*	MPLAB In-Circuit Debugger 2 Evaluation Kit includes ICD 2 Module, USB Cable, ICD Cable, Serial Cable, and PICDEM™ 2 Plus and Power Supply.
DV164007(2)*	MPLAB In-Circuit Debugger 2 Module includes ICD 2 Module, USB Cable, ICD Cable, Serial Cable and Power Supply.

*Contact Microchip Technology Inc. for availability date.

ICEPIC™ Emulator Systems

The ICEPIC Emulator System is a low cost In-Circuit Emulation System manufactured for Microchip by RF Solution LTD. The modular system consists of a common POS and interchangeable daughter board, which is device specific driven. Select the POD and daughter board from the chart below by determining the part number of the device being used and selecting the appropriate numbers. Ordering a complete system requires two part numbers (POD and daughter board).

Model Name/ Part Number	ICEPIC	
	Pod	Daughter Board
PIC12C508*	EM167200	AC165201
PIC12C509*	EM167200	AC165201
PIC14000	EM167200	N/A
PIC16C52	EM167200	AC165201
PIC16C54	EM167200	AC165201
PIC16C54A	EM167200	AC165201
PIC16C55	EM167200	AC165201
PIC16C554	EM167200	AC165208
PIC16C558	EM167200	AC165208
PIC16C56	EM167200	AC165201
PIC16C57	EM167200	AC165201
PIC16C58A	EM167200	AC165201
PIC16C84	EM167200	AC165212
PIC16C620	EM167200	AC165202
PIC16C621	EM167200	AC165202
PIC16C622	EM167200	AC165202
PIC16C62A	EM167200	AC165207
PIC16C63	EM167200	AC165207
PIC16C642	EM167200	AC165213
PIC16C64A	EM167200	AC165207
PIC16C65A	EM167200	AC165207

Model Name/ Part Number	ICEPIC	
	Pod	Daughter Board
PIC16C66	EM167200	AC165214
PIC16C662	EM167200	AC165213
PIC16C67	EM167200	AC165214
PIC16C71	EM167200	AC165211
PIC16C710	EM167200	AC165211
PIC16C711	EM167200	AC165211
PIC16C715	EM167200	AC165215
PIC16C72	EM167200	AC165207
PIC16C73A	EM167200	AC165207
PIC16C74A	EM167200	AC165207
PIC16C76	EM167200	AC165214
PIC16C77	EM167200	AC165214
PIC16C77X	EM167200	AC165217
PIC16C923	EM167200	AC165210
PIC16C924	EM167200	AC165210
PIC16F73, 74, 76, 77	EM167200	AC165218
PIC16F77X	EM167200	AC165217
PIC16F83, 84	EM167200	AC165212
PIC16F873, 874, 876, 877	EM167200	AC165216

* ICEPIC PIC12CXXX emulation support also requires the use of a kit daughter board adapter AC122002.

DEVELOPMENT SYSTEMS

PICmicro Microcontroller and Memory Software Tools, Programmers and Demonstration Boards

	PIC12CXX	PIC16C5X	PIC16C6X	PIC16CXX	PIC16C7X	PIC16C7XX	PIC16C8X	PIC16F87X	PIC16C9XX	PIC17CXX	PIC18CXX	PIC18FXX	24CXX/93CXX
Software Tools													
MPLAB® Integrated Development Environment	SW007002	SW007002	SW007002	SW007002	SW007002	SW007002	SW007002	SW007002	SW007002	SW007002	SW007002	SW007002	SW007002
PICC™ Compiler (HI-TECH C Compiler)	***	***	***	***	***	***	***	***	***	***	***	***	–
Embedded Workbench (IAR C Compiler)	–	–	****	****	****	****	****	****	****	****	****	****	–
MPLAB C17 Compiler	–	–	–	–	–	–	–	–	–	SW006010	–	–	–
MPLAB C18 Compiler	–	–	–	–	–	–	–	–	–	–	SW006011	SW006011	–
Programmers													
PICSTART® Plus Low-Cost Development Kit	DV003001	DV003001	DV003001	DV003001	DV003001	DV003001	DV003001	DV003001	DV003001	DV003001	DV003001	DV003001	–
PRO MATE® II Universal Programmer	DV007003	DV007003	DV007003	DV007003	DV007003	DV007003	DV007003	DV007003	DV007003	DV007003	DV007003	DV007003	DV007003**
ICSP™ Programming Socket for PRO MATE II	AC004004	–	AC004004	AC004004	AC004004	AC004004	AC004004	AC004004	AC004004	AC004004**	AC004004**	AC004004**	–
Demonstration Boards													
PICDEM™ 1	–	DM163001**	–	DM163001**	–	DM163001**	DM163001**	–	–	DM163001**	–	–	–
PICDEM 2 Plus	–	–	DM163022**	DM163022**	DM163022**	DM163022**	–	DM163022**	–	–	DM163022**	–	–
PICDEM 3	–	–	–	–	–	–	–	–	DM163003	–	–	–	–
PICDEM 14A	DM143001	–	–	–	–	–	–	–	–	–	–	–	–
PICDEM 17 Development Kit	–	–	–	–	–	–	–	–	–	DM173001**	–	–	–

* Contact Microchip Technology Inc. for availability date.

** Development tool is available on select devices. Please refer to the Microchip Development Systems Ordering Guide (DS30177) for device-specific ordering numbers and more information.

*** HI-TECH Software LLC Telephone 1-800-735-5715 U.S.A., Telephone 61 7 3354 2411 Australia or Web Site www.htsoft.com

**** IAR Systems Software Inc., Telephone 1-415-765-5500 U.S.A., Telephone 46 18 16 7000 or Web Site www.iar.com

† Contact Microchip Technology Inc.'s web site at www.microchip.com for information on how to use the MPLAB In-Circuit Debugger (DV164001) with PIC16C62, 63, 64, 65, 72, 73, 74, 76, 77 (see Technical Brief, TP033).

In addition to Microchip Development Tools, a wide range of emulators, programmers (single and gang), software (including compilers, RTOS, TCP/IP stack, etc.) evaluation and demonstration boards (PICmicro specific, CAN, LIN, USB, etc.) training tools, analyzers and other products are offered, please see the Microchip Third Party Guide (DS00104), which is available in book form from your local Microchip Sales Office, on the MPLAB IDE CD-ROM, or on our web site at www.microchip.com.

Programmer Adapter Kits

	PICSTART PLUS - DV003001	PRO MATE II - DV007003
68 Pin PLCC Adapter Kit	AC164024	Select on Pages 34-36
84 Pin PLCC Adapter Kit	AC164027	Select on Pages 34-36
28 Pin MLF Adapter Kit	AC164031	AC164031
40 Pin PDIP Universal Programming Kit	AC162049	AC162049

RFID Evaluation/Developer's Kits

	MCRF200	MCRF250	MCRF355	MCRF450/452
RFID Developer's Kits				
125 kHz microID® Developer's Kit for MCRF200	DV103001	–	–	–
125 kHz Anti-Collision microID Developer's Kit for MCRF250	–	DV103002	–	–
13.56 MHz Anti-Collision microID Developer's Kit for MCRF355, 360, 450, 452	–	–	DV103003, DV103005	DV103005
microID Programmer Kit only for MCRF200, MCRF250	PG103001	PG103001	–	–
microID Programmer Kit only for MCRF355	–	–	PG103003	–
Extra Card Pack for the 125 kHz microID Developer's Kit for MCRF200	AC103001	–	–	–
Extra Card Pack for the 125 kHz Anti-Collision microID Developer's Kit for MCRF250	–	AC103002	–	–

Memory Evaluation/Developer's Kits		
SEEVAL™ Serial EEPROM Developer's Kit	DV243001	All serial EEPROMS, 24XX, 93XX, 25XX series

KEELOQ® Evaluation Kits									
	HCS101	HCS200/201	HCS300/301/320	HCS360/361	HCS362	HCS365/370	HCS410/412	HCS473	HCS500/512/515
KEELOQ Evaluation Kit	DM303002	DM303002	DM303002	DM303002	DM303002	–	–	–	DM303002
KEELOQ Transponder Evaluation Kit	–	–	–	–	–	–	DM303005	–	–
KEELOQ Evaluation Kit II*	DM303006	DM303006	DM303006	DM303006	DM303006	DM303006	DM303006	DM303006	DM303006
PRO MATE II Universal Programmer for SOIC	AC004002	AC004002	AC004002	AC004002	AC004002	AC004003	AC004002	AC004003	–
PRO MATE II Universal Programmer for DIP	AC004001	AC004001	AC004001	AC004001	AC004001	AC004007	AC004001	AC004007	–
PRO MATE II Universal Programmer for ICSP™	AC004004	AC004004	AC004004	AC004004	AC004004	AC004004	AC004004	AC004004	AC004004

* Contact Microchip Technology Inc. for availability date.

Analog Evaluation/Developer's Kits												
	MCP3001/02	MCP3004/08	MCP3201/02	MCP3204/08	MCP60X	MCP41XXX/ 42XXX	TC642/46	TC650/51	TC652/53	TC74	TC3401/05	TC3400/01/ 02/03/04/05
Analog Evaluation Kits												
Analog Evaluation Driver Board	DVMCPA	DVMCPA	DVMCPA	DVMCPA	–	DVMCPA						
Evaluation Board	DV3201A**	DV3204A**	DV3201A**	DV3204A**	–	DV42XXX**						
FilterLab™ Active Filter Design Tool					FilterLab*							
Thermal Management Tools												
Fan Controller Demo Board							TC642Demo	TC650Demo	TC652Demo			
Fan Controller Evaluation Kit							TC642EV			TC74Demo		
Serial Digital Thermal Sensor Demo Board												
Data Converter Tools												
Sigma-Delta A/D Family Demo Board											TC3400Demo	
Sigma-Delta A/D Family Evaluation Kit												TC3400EV

* Available for download from Microchip Technology Inc.'s web site at www.microchip.com

** Must be ordered with DVMCPA.

Connectivity Evaluation/Developer's Kits												
	MCP2120	MCP2150/55	MCP2510	MCP250XX	PIC18C658	PIC18C858	PIC16C745	PIC16C765	PIC16F877	PIC16C432	PIC16C433	PIC16C7XX
MCP2120/2150 Developer's Kit	DM163008	DM163008										
MCP2510 CAN IC Evaluation/Developer's Kit			DV251001									
MCP250XXX CAN Mixed Signal/IO Expander Kit				DV250501								
PICDEM™ CAN Microcontroller Kit					DM163011	DM163011						
PICDEM™ USB Evaluation/Developer's Kit							DM163010	DM163010				
PICDEM.net™ Evaluation/Developer's Kit									DM163004			
PICDEM™ LIN Evaluation/Developer's Kit										DM163005*	DM163005*	
PICDEM™ MSC1 Evaluation/Developer's Kit												DM163012

* Contact Microchip Technology Inc. for availability date.

FUTURE MICROCHIP PRODUCTS

PICmicro® MICROCONTROLLER (MCU) PRODUCTS

Product	Program Memory			EEPROM Data Memory Bytes	RAM Bytes	I/O Pins	Packages	Analog		Digital			Max Speed MHz	ICSP™	BOR/PBOR	PLVD	CCP/ECCP	Other Features
	Bytes	OTP/FLASH Words	ROM Words					8-Bit ADC Channels	Comparators	PWM 10-Bit	Timers/WDT	Serial I/O						
PIC16FXXX FLASH MCUs: Upwardly Compatible with PIC16C5X/PIC12CXXX, 4-12 Interrupts, 200ns Instruction Execution, 35 Instructions, 25mA source/sink per I/O																		
PIC16F87	7168 (FLASH)	4096x14 (FLASH)	—	256	368	16	18P, 18SO, 20SS	—	2	1	2-8 bit, 1-16 bit, 1-WDT	AUSART	20	✓	✓	—	1	4 MHz Internal Oscillator, Self-Programming, ICD
PIC16F88	7168 (FLASH)	4096x14 (FLASH)	—	256	368	16	18P, 18SO, 20SS	4 (10-bit)	2	1	2-8 bit, 1-16 bit, 1-WDT	AUSART	20	✓	✓	—	1	4 MHz Internal Oscillator, Self-Programming, ICD
PIC16F818	1792 (FLASH)	1024x14 (FLASH)	—	128	128	16	18P, 18SO	5 (10-bit)	—	1	1x16-bit, 2x8-bit, 1-WDT	I ² C/SPI	20	✓	✓	—	1	4MHz Internal Oscillator, Self-Programming, ICD
PIC16F819	3584 (FLASH)	2048x14 (FLASH)	—	256	256	16	18P, 18SO	5 (10-bit)	—	1	1x16-bit, 2x8-bit, 1-WDT	I ² C/SPI	20	✓	✓	—	1	4MHz Internal Oscillator, Self-Programming, ICD
PIC18FXXX FLASH MCUs: Upwardly Compatible with PIC17C7XX/PIC16CXX/PIC16C5X/PIC12CXXX, 77 Instructions, C-compiler Efficient Instruction Set, Software Stack Capability, Table Read/Write, Switchable Oscillator Sources, 4xPLL, 25mA Source/Sink per I/O, 10-12 MIPS																		
PIC18F2220	4096 (FLASH)	2048x16 (FLASH)	—	256	512	23	28P, 28SO	10 (10-bit)	2	2	3-16 bit, 1-8 bit, 1-WDT	AUSART/Mi ² C/SPI	40	✓	✓ P	✓	2	Self-Programming, Low Power Modes , 8MHz internal RC, ICD
PIC18F2320	8192 (FLASH)	4096x16 (FLASH)	—	256	512	23	28SP, 28SO	10 (10-bit)	2	2	3-16 bit, 1-8 bit, 1-WDT	AUSART/Mi ² C/SPI	40	✓	✓ P	✓	2	Self-Programming, Low Power Modes , 8MHz internal RC, ICD
PIC18F2331	8192 (FLASH)	4096x16 (FLASH)	—	128	512	22	28SP, 28SO	5 (10-bit)	—	2-10 bit 1-3φ	1-8 bit, 3-16 bit, 1-WDT	AUSART/Mi ² C/SPI	40	✓	✓ P	✓	2	Internal Oscillator, Self-Programming, 3-ch, 12-bit Motor PWM, 2-ch Quadrature Encoder, ICD
PIC18F2431	16384 (FLASH)	8192x16 (FLASH)	—	256	768	22	28SP, 28SO	5 (10-bit)	—	2-10 bit 1-3φ	1-8 bit, 3-16 bit, 1-WDT	AUSART/Mi ² C/SPI	40	✓	✓ P	✓	2	Internal Oscillator, Self-Programming, 3-ch, 12-bit Motor PWM, 2-ch Quadrature Encoder, ICD
PIC18F4220	4096 (FLASH)	2048x16 (FLASH)	—	256	512	34	40P, 44PT	13 (10-bit)	2	2	3-16 bit, 1-8 bit, 1-WDT	AUSART/Mi ² C/SPI	40	✓	✓ P	✓	1/1	Self-Programming, PSP, Low Power Modes , 8 MHz internal RC, ICD
PIC18F4320	8192 (FLASH)	4096x16 (FLASH)	—	256	512	34	40P, 44PT	13 (10-bit)	2	2	3-16 bit, 1-8 bit, 1-WDT	AUSART/Mi ² C/SPI	40	✓	✓ P	✓	1/1	Self-Programming, PSP, Low Power Modes , 8 MHz internal RC, ICD
PIC18F4331	8192 (FLASH)	4096x16 (FLASH)	—	128	512	34	40P, 44PT	9 (10-bit)	—	2-10 bit 1-4φ	1-8 bit, 3-16 bit, 1-WDT	AUSART/Mi ² C/SPI	40	✓	✓ P	✓	2	Internal Oscillator, Self-Programming, 4-ch, 12-bit Motor PWM, 2-ch Quadrature Encoder, ICD
PIC18F4431	16384 (FLASH)	8192x16 (FLASH)	—	256	768	34	40P, 44PT	9 (10-bit)	—	2-10 bit 1-4φ	1-8 bit, 3-16 bit, 1-WDT	AUSART/Mi ² C/SPI	40	✓	✓ P	✓	2	Internal Oscillator, Self-Programming, 4-ch, 12-bit Motor PWM, 2-ch Quadrature Encoder, ICD



PICmicro® MICROCONTROLLER (MCU) PRODUCTS

Product	Program Memory			EEPROM Data Memory Bytes	RAM Bytes	I/O Pins	Packages	Analog		Digital			Max Speed MHz	ICSP™	BOR/ PBOR	PLVD	CCP/ ECCP	Other Features
	Bytes	OTP/ FLASH Words	ROM Words					8-Bit ADC Channels	Comparators	PWM 10-Bit	Timers/WDT	Serial I/O						
PIC18FXXX FLASH MCUs: Upwardly Compatible with PIC17C7XX/PIC16CXX/PIC16C5X/PIC12CXXX, 77 Instructions, C-compiler Efficient Instruction Set, Software Stack Capability, Table Read/Write, Switchable Oscillator Sources, 4xPLL, 25mA Source/Sink per I/O, 10-12 MIPS (continued)																		
PIC18F6520	32768 (FLASH)	16384x16 (FLASH)	—	1024	3840	52	64PT	12 (10-bit)	2	5	2-8 bit, 3-16 bit, 1-WDT	² AUSART/ Mi ² C/SPI	40	✓	✓ P	✓	5	PSP, Self-Programming, ICD
PIC18F6680	65536 (FLASH)	32768x16 (FLASH)	—	1024	3328	52	64PT, 68L	12 (10-bit)	2	2	1-8 bit, 3-16 bit, 1-WDT	AUSART/ Mi ² C/SPI/ CAN 2.0B	40	✓	✓ P	✓	1/1	Full CAN 2.0B, 3 transmit buffers, 8 receive buffers, 16 acceptance filters, 2 filter masks, PSP, Self-Programming, ICD
PIC18F8520	32768 (FLASH)	16384x16 (FLASH)	—	1024	3840	68	80PT	16 (10-bit)	2	5	2-8 bit, 3-16 bit, 1-WDT	² AUSART/ Mi ² C/SPI	40	✓	✓ P	✓	5	PSP, Self-Programming, EMA, ICD
PIC18F8680	65536 (FLASH)	32768x16 (FLASH)	—	1024	3328	68	80PT	16 (10-bit)	2	2	1-8 bit, 3-16 bit, 1-WDT	AUSART/ Mi ² C/SPI/ CAN 2.0B	40	✓	✓ P	✓	1/1	Full CAN 2.0B, 3 transmit buffers, 8 receive buffers, 16 acceptance filters, 2 filter masks, PSP, Self-Programming, ICD

Abbreviations:

ADC = Analog-to-Digital Converter
AUSART = Addressable USART
BOR = Brown-out Detection/Reset
CAP = Capture
CCP = Capture/Compare/PWM
DAC = Digital-to-Analog Converter
3φ = 3 Phase PWMs
4φ = 4 Phase PWMs

E2 = EEPROM (Reprogrammable)
ECCP = Enhanced Capture/Compare/PWM
EMA = External Memory Addressing
I²C = Inter-Integrated Circuit Bus
ICSP = In-Circuit Serial Programming
ICD = In-Circuit Debug
LVD = Low Voltage Detection
LIN XCVR = Local Interconnection Network Transceiver

Mi²C/SPI = Master I²C/SPI
PBOR = Programmable Brown-Out Detection/Reset
PLVD = Programmable Low-Voltage Detection
PSP = Parallel Slave Port
PWM = Pulse Width Modulator
PSMC = Programmable Switch Mode Controller
SLAC = Slope A/D Converter, up to 16 bits

SMB = System Management Bus
SPI = Serial Peripheral Interface
USART = Universal Synchronous/Asynchronous Receiver/Transmitter
USB = Universal Serial Bus
VREF = Voltage Reference
WDT = Watchdog Timer
✓ P = Programmable

*Contact Microchip Technology for availability date.

dsPIC™ MICROCONTROLLER (MCU) PRODUCTS

Product	Program (FLASH) KBytes	Memory (FLASH) KWords	EE Bytes	SRAM Bytes	Packages	A/D 12-bit 100 KSPS	A/D 10-bit 500 KSPS	Timer 16-bit	Input Cap	Output Comp/Std PWM	Motor Control PWM	Quad Enc.	UART	SPI	I ² C	CAN	Codec Interface
dsPIC30F2010	12	4	1024	512	28SO, 28SP		6 ch	3	4	2	6	Yes	1	1	1	No	No
dsPIC30F2011	12	4	0	1024	18SO, 18P	8 ch		3	2	2	no	No	1	1	1	No	No
dsPIC30F2012	12	4	0	1024	28SO, 28SP	10 ch		3	2	2	no	No	1	1	1	No	No
dsPIC30F3010	24	8	1024	1024	28SO, 28SP		6 ch	5	4	2	6	Yes	1	1	1	No	No
dsPIC30F3011	24	8	1024	1024	40P, 44PT		9 ch	5	4	4	6	Yes	2	1	1	No	No
dsPIC30F3012	24	8	1024	2048	18SO, 18P	8 ch		3	2	2	No	No	1	1	1	No	No
dsPIC30F3013	24	8	1024	2048	28SO, 28SP	10 ch		3	2	2	No	No	2	1	1	No	No
dsPIC30F4010	36	12	1024	2048	64PT		16 ch	5	8	8	8	Yes	2	2	1	1	No
dsPIC30F4011	48	16	1024	2048	40P, 44PT		9 ch	5	4	4	6	Yes	2	1	1	1	No
dsPIC30F4012	48	16	1024	2048	28SO, 28SP		6 ch	5	4	2	6	Yes	1	1	1	1	No
dsPIC30F5010	96	32	2048	4096	64PT		16 ch	5	8	8	8	Yes	2	2	1	2	No
dsPIC30F5011	66	22	1024	4096	64PT	16 ch		5	8	8	No	No	2	2	1	2	No
dsPIC30F5012	96	32	2048	4096	64PT	16 ch		5	8	8	No	No	2	2	1	2	AC97, I ² S
dsPIC30F5013	66	22	1024	4096	80PT	16 ch		5	8	8	No	No	2	2	1	2	No
dsPIC30F5014	96	32	2048	4096	80PT	16 ch		5	8	8	No	No	2	2	1	2	AC97, I ² S
dsPIC30F6010	144	48	4096	8192	80PT		16 ch	5	8	8	8	Yes	2	2	1	2	No
dsPIC30F6011	132	44	2048	6144	64PT	16 ch		5	8	8	No	No	2	2	1	2	No
dsPIC30F6012	144	48	4096	8192	64PT	16 ch		5	8	8	No	No	2	2	1	2	AC97, I ² S
dsPIC30F6013	132	44	2048	6144	80PT	16 ch		5	8	8	No	No	2	2	1	2	No
dsPIC30F6014	144	48	4096	8192	80PT	16 ch		5	8	8	No	No	2	2	1	2	AC97, I ² S

*Contact Microchip Technology for availability date.

ANALOG/INTERFACE PRODUCTS

Thermal Management - Temperature Sensors

Part #	Interface	Temperature Range (°C)	Operating Voltage	Typical Operating Current (µA)	Packages
TC77	SPI™/MICROWIRE™	-55° to +125°	2.7V to 5.5V	200	5-Pin SOT-23, 8-Pin SOIC

Thermal Management - Brushless DC Fan Controllers

Part #	Description	Temperature Range (°C)	Operating Voltage (V)	Typical Operating Current(mA)	Features	Packages
TC654	Dual SMBus™ Fan Manager	-40 to +85	3.0 to 5.5	0.2	FanSense™ fan monitor, RPM data	10-Pin MSOP
TC655	Dual SMBus™ Fan Manager	-40 to +85	3.0 to 5.5	0.2	FanSense™ fan monitor, RPM data, over-temperature alert	10-Pin MSOP

Power Management - CPU/System Supervisors

Part #	Vcc Range (V)	Reset Voltages (V)	Reset Type	Output Type	Typical Reset Pulse Width (ms)	Typical Supply Current (µA)	Features	Packages
MCP102	1.0 to 5.5	4.62, 4.38, 3.07, 2.92, 2.63	Active Low	CMOS Push-Pull	90	1.0	Very low active current	3-Pin SOT-23, 3-Pin TO-92, 3-Pin SC-70
MCP103	1.0 to 5.5	4.62, 4.38, 3.07, 2.92, 2.63	Active Low	CMOS Push-Pull	90	1.0	Very low active current	3-Pin SOT-23, 3-Pin TO-92, 3-Pin SC-70
MCP121	1.0 to 5.5	4.62, 4.38, 3.07, 2.92, 2.63	Active Low	Open Drain	90	1.0	Very low active current	3-Pin SOT-23, 3-Pin TO-92, 3-Pin SC-70
MCP131	1.0 to 5.5	4.62, 4.38, 3.07, 2.92, 2.63	Active Low	Open Drain/50KΩ Pull-Up	90	1.0	Very low active current	3-Pin SOT-23, 3-Pin TO-92, 3-Pin SC-70

Linear - Audio Amplifiers

Part #	# of Channels	Supply Voltage Range (V)	Typical Output Power	Typical THD Rating (%)	Amplifier Type	Packages
TC4871	1	2.0 to 5.5	3W	0.25	Class AB	8-Pin MSOP, 8-Pin SOIC
TC4890	1	2.0 to 5.5	1W	0.1	Class AB	8-Pin MSOP, 8-Pin SOIC
MCP6800/1	1	2.5 to 5.5	0.8W	0.1	Class D	8-Pin MSOP, 8-Pin SOIC

ANALOG/INTERFACE PRODUCTS

Linear - Op Amps

Part #	# of Channels	I _q (μA)	V _{os}	GBWP	Operating Voltage (V)	Temperature Range (°C)	Features	Packages
MCP6001	1	150	10mV	1 MHz	1.8 to 5.5	-40 to +85	Rail-to-Rail Input/Output	5-Pin SOT23, 5-Pin SC-70
MCP6002	2	150	10mV	1 MHz	1.8 to 5.5	-40 to +85	Rail-to-Rail Input/Output	8-Pin PDIP, 8-Pin SOIC, 8-Pin MSOP
MCP6004	4	150	10mV	1 MHz	1.8 to 5.5	-40 to +85	Rail-to-Rail Input/Output	14-Pin PDIP, 14-Pin SOIC, 14-Pin TSSOP

Interface - CAN Peripheral Products

Part #	Operating Voltage (V)	Temperature Range (°C)	Maximum CAN Bus Speed	Features	Packages
MCP2551	2.7 to 5.5	-40 to +125	1M bps	High speed CAN transceiver, ISO 11898 compatible, industry-standard pinout	8-Pin PDIP, 8-Pin SOIC

PIN AND CODE COMPATIBILITY CHART

8-pin PICmicro® MCU Family

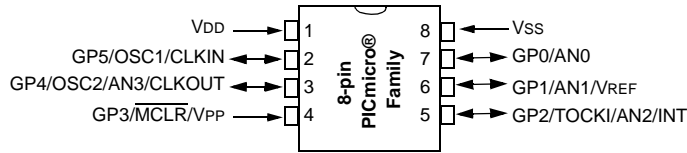

PIC12C508A	PIC12CE519	PIC12CE673
PIC12C509A	PIC12C671	PIC12CE674
PIC12CR509A	PIC12C672	PIC12F629
PIC12CE518		PIC12F675

18-pin PICmicro® MCU Family

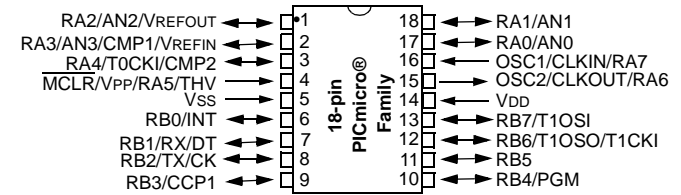

PIC16C620A	PIC16CE623	PIC16C710	PIC16F84A
PIC16CR620A	PIC16CE624	PIC16C711	PIC16F818
PIC16C621A	PIC16CE625	PIC16C712	PIC16F819
PIC16C622A	PIC16F627	PIC16C715	
	PIC16F628	PIC16C716	

20-pin PICmicro® MCU Family

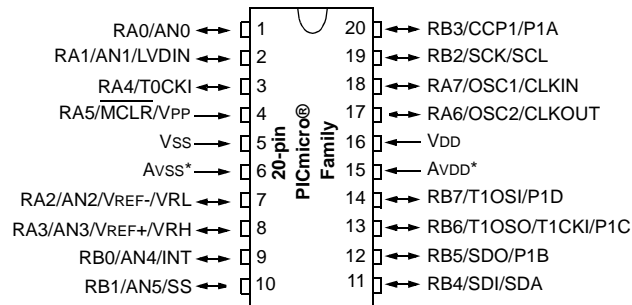

PIC16C717*	PIC16C771	PIC18F1220*
PIC16C770	PIC16C781	PIC18F1320*
	PIC16C782	

*18 pin device; AVSS and AVDD are not valid pins for this device

8-pin KEELoQ® Family

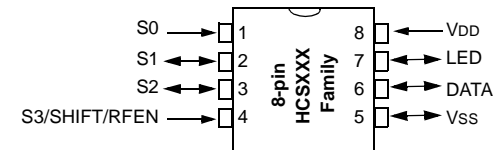

HCS101	HCS300	HCS360
HCS200	HCS301	HCS361
HCS201	HCS320	HCS362
		HCS365

PIN AND CODE COMPATIBILITY CHART (CONTINUED)

28-pin PICmicro® MCU Family

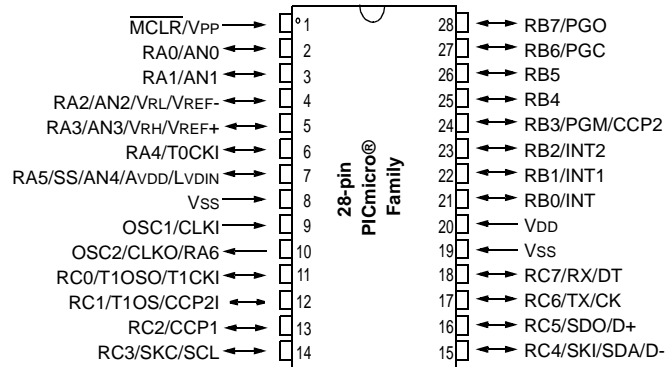

PIC16C62B	PIC16F76	PIC16F876
PIC16CR63	PIC16C642	PIC16F876A
PIC16C63A	PIC16C745	PIC18C242
PIC16C66	PIC16C773	PIC18C252
PIC16CR72	PIC16F870	PIC18F2220
PIC16C72A	PIC16F872	PIC18F2320
PIC16F72	PIC16F873	PIC18F242
PIC16C73B	PIC16F873A	PIC18F252
PIC16C76		PIC18F248
PIC16F73		PIC18F258

40-pin PICmicro® MCU Family

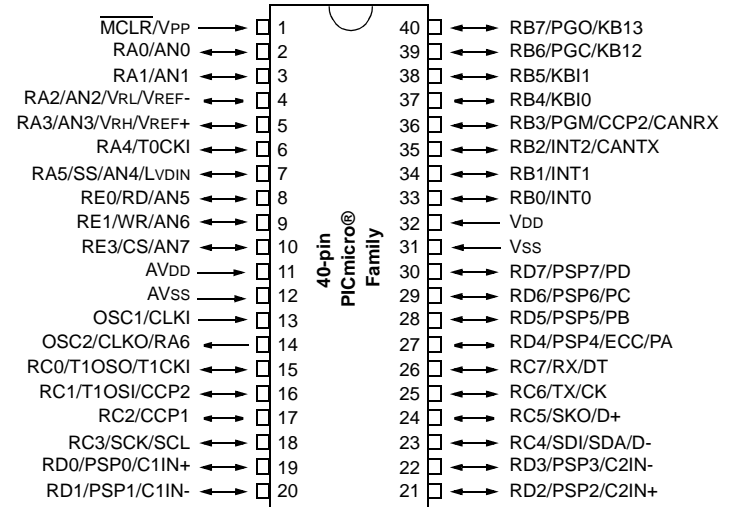

PIC16CR65	PIC16C765	PIC18C442
PIC16C65B	PIC16C774	PIC18C452
PIC16C67	PIC16F871	PIC18F4220
PIC16C662	PIC16F874	PIC18F4320
PIC16C74B	PIC16F874A	PIC18F442
PIC16C77	PIC16F877	PIC18F452
PIC16F74	PIC16F877A	PIC18F448
PIC16F77		PIC18F458

Pin Count/
Packaging

MICROCHIP PACKAGE OPTIONS

CERAMIC DUAL IN-LINE CERDIP



18-LEAD CERDIP
JW



20-LEAD CERDIP
JW



28-LEAD CERDIP
JW



40-LEAD CERDIP
JW

PLASTIC DUAL IN-LINE PDIP



8-LEAD PDIP
P OR PA



14-LEAD PDIP
P OR PD



18-LEAD PDIP
P



20-LEAD PDIP
P



24-LEAD PDIP
P OR PG



28-LEAD PDIP
P OR PI



28-LEAD SKINNY PDIP
SP OR PJ



40-LEAD PDIP
P OR PL



64-LEAD SHRINK PDIP
SP

PLASTIC LEADED CHIP CARRIER PLCC



32-LEAD PLCC
L



44-LEAD PLCC
L OR LW



68-LEAD PLCC
L OR LS



84-LEAD PLCC
L

CERAMIC CHIP CARRIER (CERQUAD)



68-LEAD CERQUAD
CL



84-LEAD CERQUAD
CL

PACKAGES ARE APPROXIMATE SIZE

**PLASTIC SMALL OUTLINE
SOIC**



**PLASTIC SHRINK
SMALL OUTLINE
SSOP**



**PLASTIC THIN QUAD
FLATPACK
TQFP**

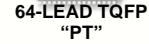

**SIDE BRAZED
DUAL-IN-LINE
JW**



**PLASTIC QUAD
FLATPACK
QFP**



**PLASTIC THIN SHRINK
SMALL OUTLINE
TSSOP**



**MICRO LEAD FRAME
MLF**



SMALL OUTLINE TRANSISTOR



PACKAGES ARE APPROXIMATE SIZE

Part Number Suffix Designations

XXXXXXXXXX - XX X/XX XXX

QTP, SQTP or ROM Code; Special Requirements

Package:

1C = 100pF COB Module, .75mm	SL = 14-lead Small Outline (150 mil)
3C = 330pF COB Module, .45mm	SM = 8-lead Small Outline (207 mil)
L = Plastic Leaded Chip Carrier (PLCC)	SN = 8-lead Small Outline (150 mil)
P = Plastic DIP	SO = Plastic Small Outline (SOIC) (300 mil)
S = Die in Wafer Pack	SP = Plastic Skinny DIP
W = Die in Wafer Form	SS = Plastic Shrink Small Outline (SSOP)
CB = Chip on Board (COB)	ST = Thin Shrink Small Outline (TSSOP 4.4 mm)
CL = Windowed CERQUAD	ST14 = 14-lead Thin Shrink Small Outline (TSSOP-14)
JW = Windowed CERDIP	TO-92 = Transistor Outline
ML = Micro Lead frame	TS = Thin Small Outline (8mm x 20mm)
MF = Micro Lead frame - 8	TT = SOT-23-3 Small Outline Transistor
MS = Micro Small Outline (MSOP)	VS = Very Small Outline (8mm x 12mm)
OT = SOT-23-5	WB = Bumped Wafer (11 mil)
PQ = Plastic Quad Flatpack (PQFP)	WF = Sawed Wafer on Frame (7 mil for 6" wafer, 8 mil for 8" wafer)
PT = Plastic Thin Quad Flatpack (TQFP)	WFB = Bumped, Sawed Wafer on Frame
SB = Bumped Die in Wafer Pack	WM = SOT385 Leadless Module

Process Temperature:

Blank = 0°C to +70°C	E (Extended) = -40°C to +125°C
I (Industrial) = -40°C to +85°C	

Speed:

OR

-90 = 90 ns
-10 = 100 ns
-12 = 120 ns
-15 = 150 ns
-17 = 170 ns
-20 = 200 ns
-25 = 250 ns
-30 = 300 ns

Crystal Frequency Designator for PICmicro MCUs

LP = DC to 40 kHz, Low Power Crystal Oscillator
RC = DC to 4 MHz, Resistor/Capacitor Oscillator
XT = DC to 4 MHz, Standard Crystal Resonator Oscillator
HS = DC to 20 MHz, High Speed Crystal Oscillator
O2 = DC to 2 MHz, XT and RC Oscillator Support
O4 = DC to 4 MHz Internal, XT and RC Oscillator Support
O4 = DC to 200 kHz, LP Oscillator Support
O8 = DC to 8 MHz, HS Oscillator Support
10 = DC to 10 MHz, HS Oscillator Support
16 = DC to 16 MHz, XT Oscillator Support
20 = DC to 20 MHz, HS Oscillator Support
25 = DC to 25 MHz, XT Oscillator Support
30 = DC to 30 MHz, HS Oscillator Support
33 = DC to 33 MHz, XT Oscillator Support
40 = DC to 40 MHz, HS Oscillator Support

Option:

T = Tape and Reel Shipments	F = twc = 200 µs
Blank = twc = 1ms	X = Rotated pinout

Device Type: (Up to 10 digits)

AA = 1.8V EEPROM Memory	LCE = Low Power CMOS EPROM/EEPROM MCU
C = CMOS EPROM/ROMless MCU	LCR = Low Power CMOS ROM MCU
CE = CMOS EPROM/EEPROM MCU	LCS = Low Power Security
CR = CMOS ROM MCU	LF = Low Power FLASH MCU
F = Flash MCU	LV = Low Voltage
HC = High Speed	24 = 2-Wire (I ² C)
HV = High Voltage	25 = SPI
LC = Low Power CMOS EPROM MCU	93 = 3-Wire (Microwire®)

Pin Count/
Packaging

Part Number Suffix Designations

Ordering Information for all Microchip Analog Products beginning with "TC" (formerly TelCom Semiconductor Products)

TC 7106 A-60 1 C P L 713

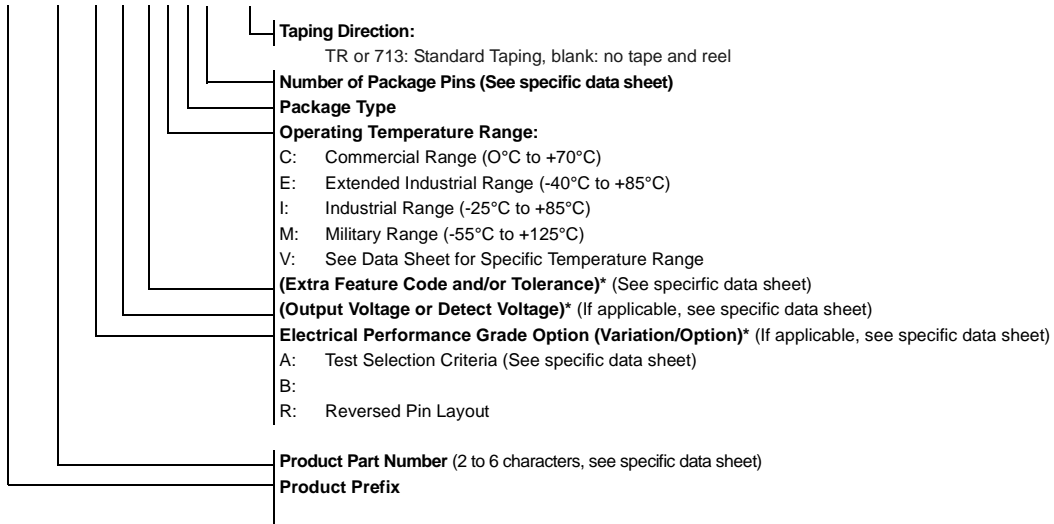

NOTE: () * Used for voltage regulators and detectors.

Package	Description	# of Pins
AB	TO-220	3
AK	TO-220	7
AT	TO-220	5
AV	TO-220 (Formed)	5
BB	TO-220B	3
CB	SOT-23A	3
CH	SOT-23A	6
CT	SOT-23A	5
DB	SOT-223	3
EB	DDPAK	3
EK	DDPAK	7
ET	DDPAK	5
HA	SOP	8
JA	CDIP (N)	8
JD	CDIP (N)	14
JE	CDIP (N)	16
JG	CDIP (W)	24
JI	CDIP (W)	28
JL	CDIP (W)	40
KU	PQFP	64
KW	PQFP	44
LB	SC-70	3
LI	PLCC	28
LS	PLCC	68
LT	SC-70	5
LW	PLCC	44

Package	Description	# of Pins
MB	SOT-89	3
MT	SOT-89	5
NB	SOT-23B	3
OA	SOIC (N)	8
OD	SOIC (N)	14
OE	SOIC (W)	16
OG	SOIC (W)	24
OI	SOIC (W)	28
OR	SOIC (N)	16
PA	PDIP (N)	8
PD	PDIP (N)	14
PE	PDIP (N)	16
PF	PDIP (N)	24
PG	PDIP (W)	24
PI	PDIP (W)	28
PJ	PDIP (W)	28
PL	PDIP (W)	40
QR	QSOP (N)	16
RC	SOT-143	4
SI	SSOP (W)	28
UA	MSOP	8
UN	MSOP	10
VB	DDPAK	3
ZB	TO-92	3
ZM	TO-92	2

Part Number Suffix Designations

Ordering Information for all Microchip Analog Products beginning with "MCP" Prefix Parts

MCP xxxxx T - yyy z h / qq

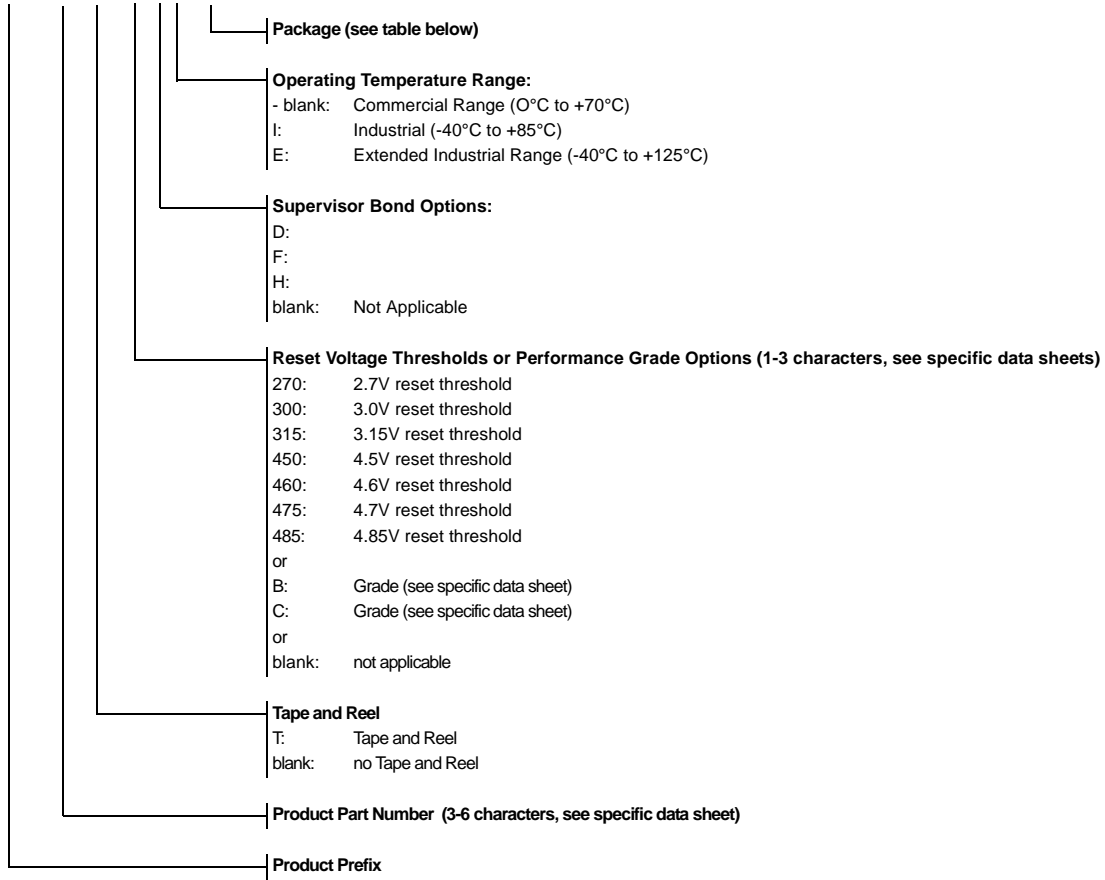

Pin Count/
Packaging

Package	Description	# of Pins	Tube/Bag Qty.	Reel Qty.
TO	TO-92	3	1000	n/a
TT	SOT-23	3	n/a	3000
OT	SOT-23	5	n/a	3000
P	PDIP	8	60	n/a
P	PDIP	14	30	n/a
P	PDIP	18	25	n/a
SN	SOIC	8	100	3300
ST	TSSOP	8	100	2500
ST	TSSOP	14	96	2500
ST	TSSOP	20	74	2500
MS	MSOP	8	100	2500
SL	SOIC	14	57	2600
SO	SOIC	18	42	1100
SS	SSOP	20	67	1600

NOTES:

Microchip Technology's Quality Policy

In order to meet or exceed customer expectations at a reduced cost, we encourage our employees to support continuous improvement, anticipate problems and implement root cause solutions.

Aggregate Approach

Microchip has instituted an "aggregate" approach to understand, align, integrate and unite all company resources. Microchip consciously designed the enterprise as an aggregate system in which company culture, systems, practices, policies and employees work in unison to achieve Microchip's mission and goals. This aggregate system and culture is taught in the Microchip Culture class required for all new hires and taught by Executive Staff members.

The Quality Culture of Microchip is that every organization, business unit and individual owns the quality of their output, whether it is product, process, software or service.

A company must aggressively pursue continuous improvement, employee development, team deployment and statistical techniques to successfully achieve individual accountability of quality.

Continuous Improvement

Microchip promotes a culture of continuous improvement. As stated above, each employee is measured on how they contribute to improvement. Continuous improvement teams are constantly looking to solve problems, allowing us to maximize our value to our customers.

Employee Development and Team Deployment

Every employee has access to a full suite of training. Each employee is measured on Quality and Quantity of work, Teamwork, Continuous Improvement and Customer Satisfaction. Supervisors are measured on how their employees improve and learn. Employees have regular One-on-Ones with their supervisors and open door is a policy that is really practiced.

Statistical Techniques

Microchip uses statistical process techniques in all aspects of our business. Decision-making, experiment definition and process control are a few areas where these techniques are applied. Every manufacturing employee is trained in SPC before they start their job, since they are the people closest to the product quality.

QS-9000 Certification

Microchip Technology's Quality System is based on QS-9000 requirements. QS-9000 is rapidly becoming the standard Quality System for many industries including Semiconductors. All Microchip product facilities and major subcontractors are QS registered. Development Systems and Mountain View products are designed, manufactured and certified to ISO-9001 requirements.

Quality Systems and Reliability Information

Visit www.microchip.com for detailed Quality Systems and Reliability information.

Microchip's Quality System is fully described in the *Microchip Overview, Quality Systems and Customer Interface Systems Handbook* (DS00169) available on our web site.

Worldwide Sales & Service

REGIONAL TECHNICAL SUPPORT:

Americas

Atlanta	770-640-0034
Boston	978-692-3848
Chicago	630-285-0071
Dallas	972-818-7423
Detroit	248-538-2250
Kokomo	765-864-8360
Los Angeles	949-263-1888
New York	631-273-5305
Phoenix	480-792-7966
San Jose	408-436-7950
Toronto	905-673-0699

Asia/Pacific

Australia	61-2-9868-6733
China - Beijing	86-10-85282100
China - Chengdu	86-28-6766200
China - Fuzhou	86-591-7503506
China - Shanghai	86-21-6275-5700
China - Shenzhen	86-755-2350361
Hong Kong	852-2401-1200
India	91-80-2290061
Japan	81-45-471-6166
Korea	82-2-554-7200
Singapore	65-6334-8870
Taiwan	886-2-2717-7175

Europe

Denmark	45-4420-9895
France	33-1-69-53-63-20
Germany	49-89-627-144-0
Italy	39-039-65791-1
United Kingdom	44-118-921-5869

TECHNICAL SERVICE:

Technical Support Hotline

Tel: 800 437-2767 U.S. & Canada
Tel: 800-820-6247 PRC
Tel: 480 792-7627 Worldwide

Development Systems Information

Tel: 800 755-2345 U.S. & Canada
Tel: 480 792-7302 Worldwide

World Wide Web Address

www.microchip.com

Customer Notification System

Register on our web site (www.microchip.com/cn) to receive the most current information on our products.

Telephone Numbers current as of March 2002



MICROCHIP

The Embedded Control Solutions Company®

Microchip Technology Inc. • 2355 W. Chandler Blvd. • Chandler, AZ 85224-6199 • (480) 792-7200 • FAX (480) 792-9210

The Microchip name and logo, the Microchip logo, PIC, PICmicro, PICMASTER, PICSTART, PRO MATE, KEELoq, SEEVAL, microID, MPLAB and The Embedded Control Solutions Company are registered trademarks of Microchip Technology Incorporated in the U.S.A. and other countries. Total Endurance, ICSP In-Circuit Serial Programming, ICEPIC, dsPIC, rPIC, FilterLab, MXDEV, MPASM, MPLINK, MPLIB, PICC, PICDEM, PICDEM.net, Migratable Memory, FanSense, ECONOMONITOR, Select Mode and microPort are trademarks of Microchip Technology Inc. Serialized Quick Term Programming (SQTP) is a service mark of Microchip Technology Incorporated in the U.S.A. All other trademarks mentioned herein are the property of their respective companies.

Information subject to change. ©2002, Microchip Technology Inc. All rights reserved. Printed in the U.S.A. 04/02 DS00148G2

