

Micro Controller Board

CPM2B

The CPM2B series programmable controllers offer the powerful features and advanced technology of Omron's brick style micros in a board package. These controllers give you advantages in programming flexibility, reduced development cost and significant space savings compared to other control solutions.

- 32-point and 40-point I/O CPU boards, expand to 168 I/O
- Peripheral communications port standard
- 20 kHz high-speed counter input
- Two, 10 kHz pulse outputs for motion applications
- Removable terminals simplify installation
- LED indicators show status
- Synchronized pulse control matches input devices to control devices for positioning
- Relay or Transistor outputs
- Analog I/O expansion boards available
- RS-232C port, backup battery and real-time clock are available on standard models
- Custom options include number/type of I/O, communication interfaces, package size and layout, real-time clock and connector types; contact your Omron representative

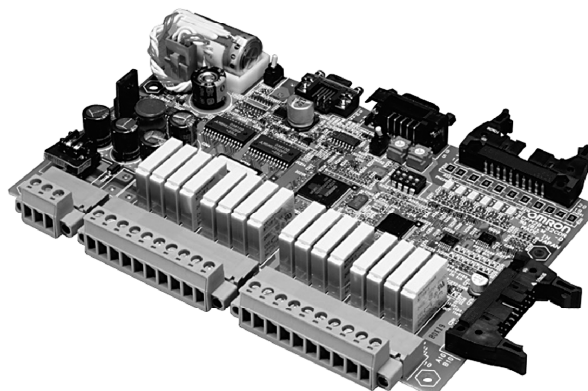

Basic Configuration

Up to three Expansion I/O boards can be connected to a CPM2B CPU board. Connecting cable CPM2B-CN601 is supplied with each Expansion I/O board. Standoffs and mounting screws are included with all boards. Order the mounting bracket separately.

CPU Board with 32 I/O points
(Relay outputs)

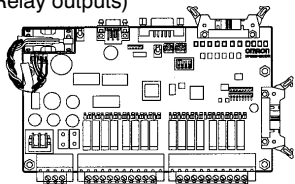

CPU Board with 32 I/O points
(Transistor outputs)

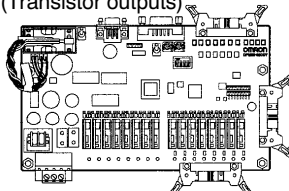

CPU Board with 40 I/O points
(Relay outputs)

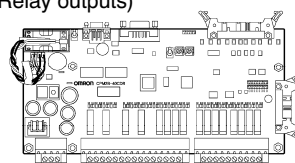

Expansion I/O board with 32 I/O points
(Relay outputs)

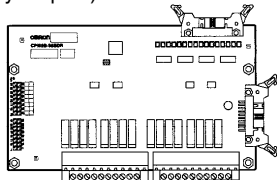

Expansion I/O board with 32 I/O points
(Transistor outputs)

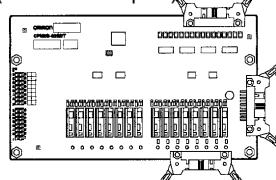

Expansion I/O board with 40 I/O points
(Relay outputs)

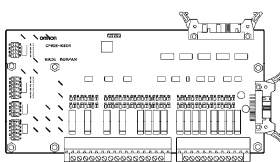

Expansion I/O board with 64 I/O points
(Transistor outputs)

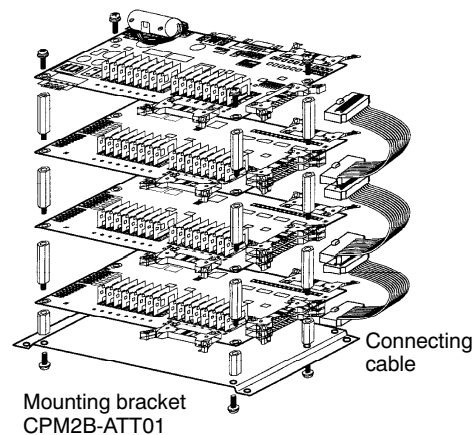
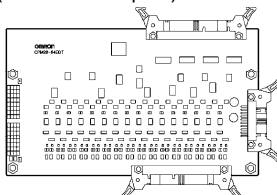

Mounting bracket
CPM2B-ATT01

Connecting cable

Ordering Information



■ CPU BOARDS

Stock Note: Shaded models are normally stocked.

Appearance	Input points	Output points	Input type	Output type	RS-232C port, real-time clock and battery backup	Part number
	16	16	24 VDC	Relay	—	CPM2B-32C1DR-D
					Yes	CPM2B-32C2DR-D
	16	16	24 VDC	Transistor (NPN)	—	CPM2B-32C1DT-D
					Yes	CPM2B-32C2DT-D
	24	24	12 VDC	Relay	No	CPM2B-32C1D1T-D12
					Yes	CPM2B-32C2D1T-D12
	24	24	24 VDC	Relay	—	CPM2B-40C2DR-D

■ EXPANSION I/O BOARDS

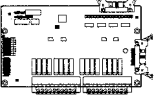
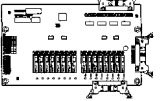
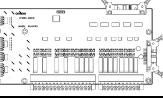
Stock Note: Shaded models are normally stocked.

Appearance	Input points	Output points	Input type	Output type	Part number
	16	16	24 VDC	Relay	CPM2B-32EDR
				Transistor (NPN)	CPM2B-32EDT
			12 VDC	CPM2B-32ED1T	
	24	16	24 VDC	Relay	CPM2B-40EDR
	32	32		Transistor	CPM2B-64EDT

■ DEDICATED I/O BOARDS



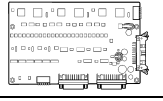
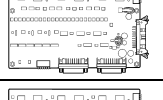
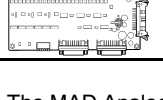

Stock Note: Shaded models are normally stocked.

Appearance	Inputs	Outputs	Part number
	2	1	CPM2B-MAD21 (See Note)
	4	2	CPM2B-MAD42 (See Note)
	6	3	CPM2B-MAD63 (See Note)

Note: The MAD Analog I/O boards cannot connect to the 12 VDC CPUs.

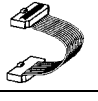
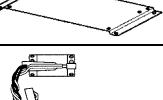

■ ACCESSORIES

Stock Note: Shaded models are normally stocked.

Appearance	Product	Description	Part number
	Expansion I/O cable	Connects Expansion I/O board to CPU or another Expansion I/O board	CPM2B-CN601
	Mounting bracket	Mounts CPM2B boards	CPM2B-ATT01
	Backup battery	Replacement battery for CPM2B	3G2A9-BAT08
	Expansion memory unit	Uploads and downloads program and setup memory areas to and from controller	CPM1-EMU01-V1
	EEPROM	EEPROM chip, 256 kbits	EEPROM-CPM1-EMU01

I/O CONNECTORS

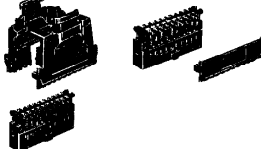
Stock Note: Shaded models are normally stocked.

Product	Description	Part number
	Discrete-wire IDC connector, 2-row socket (AWG 24 wire)	XG5M-2032-N
	Discrete-wire IDC connector, 2-row socket (AWG 26 to 28)	XG5M-2035-N
	Discrete-wire IDC connector, 2-row socket (full cover)	XG5S-2012
	Discrete-wire IDC connector, 2-row socket (partial cover)	XG5S-1001
	Flat cable connector, MIL-type socket (connector housing)	XG4M-2030
	Flat cable connector, MIL type socket (strain relief)	XG4T-2004

SERIAL COMMUNICATIONS ADAPTERS AND CABLES

Stock Note: Shaded models are normally stocked.

Product	Description	Cable length	Part number
RS-232C adapter	Converts CPM2B peripheral port to RS-232C; DIN mount	-	CPM2C-CIF01-V1
	Converts peripheral port to RS-232C; DIN mount	0.2 m (0.66 ft)	CPM1-CIF01
	Program download cable to 9 pin computer serial port	3.3 m (10.8 ft)	CQM1-CIF02
RS-422/RS-485 adapter	Converts mini-peripheral port to RS-422/RS-485 and RS-232C; DIN mount	-	CPM2C-CIF11
	Converts mini-peripheral port to adapter RS-422A, DIN mount	-	CQM1H-CIF12
RS-232C cable	Program download cable from computer to Omron DB9 serial port	2 m (6.6 ft)	C200HS-CN220-EU CBL-202*
	Communication cable to other Omron devices with DB9 serial port	0.5 m (1.64 ft)	C200H-CN510-EU
		2 m (6.6 ft)	C200H-CN320-EU CBL-804*
		5 m (16.4 ft)	C200H-CN520-EU
	Program download cable to 9 pin computer serial port	2 m (6.6 ft)	C200H-CN229-EU CBL-202*
Peripheral port cable	Mini-peripheral port adapter cable	5 cm	CS1W-CN114

* Available in Canada only.

PERIPHERAL DEVICES

Stock Note: Shaded models are normally stocked.

Product	Description	Part number
Programming console	Handheld programmer with 2 m cable attached; connects directly to peripheral port	CQM1-PRO01-E
	Handheld programmer with backlit display; order cable separately below.	C200H-PRO27-E
Connecting cable	Connects C200H programmer to peripheral port; 2 m cable	C200H-CN222
	Connects C200H programmer to peripheral port; 4 m cable	C200H-CN422

SUPPORT SOFTWARE

Stock Note: Shaded models are normally stocked.

Product	Functions	Part number
CX-Programmer Jr.	Windows-based programming software; reduced instruction set and networking commands.	WS02-CXPC1-EJ-V_..
CX-Programmer	Full programming software package programs micro, small and larger controllers.	WS02-CXPC1-E-V_..

■ **MANUALS**

Product	Description	Part number
Operation manual	CPM2B Programmable Controller Operation manual	W371
Programming manual	CPM1/CPM1A/CPM2A/CPM2C/SRMI(-V2) programming manual	W353

■ **ROTARY ENCODERS FOR HIGH-SPEED COUNTER INPUTS**

Stock Note: Shaded models are normally stocked.

Product	Description	Part number
Incremental encoders	Differential phase mode, 5 kHz count frequency, NPN open collector	E6B2-CWZ6C
	Pulse plus direction mode, 20 kHz count frequency	E6A2-CS5C

Specifications

■ **GENERAL SPECIFICATIONS**

Item	CPU Boards			Expansion I/O Boards	
	With relay outputs	With transistor outputs		With relay outputs	With transistor outputs
Model	CPM2B-32C□DR-D CPM2B-40C2DR-D	CPM2B-32C□DT-D	CPM2B-32C□DT1-D12	CPM2B-32EDR CPM2B-40EDR	CPM2B-32EDT CPM2B-32ED1T CPM2B-64EDT
Supply voltage	24 VDC (Allowable range: 20.4 to 26.4 VDC)		12 VDC (Allowable range: 10.8 to 13.2 VDC)	Supplied from CPU board	
Power consumption	20 W max.			—	
Inrush current	20 A max.			—	
Insulation resistance	20 MΩ min. (at 500 VDC) between the external DC terminals and non-current carrying metal parts				
Dielectric strength	1,000 VAC 50/60 Hz for 1 min between the external DC terminals and non-current carrying metal parts				
Noise immunity	Conforms to IEC6100-4-4; 2 kV (power lines)				
Vibration resistance	10 to 57 Hz, 0.075-mm amplitude, 57 to 150 Hz, acceleration: 9.8 m/s ² in X, Y, and Z directions for 80 minutes each (8 minutes of vibration × 10 repetitions= total time 80 minutes)				
Shock resistance	147 m/s ² three times each in X, Y, and Z directions				
Ambient temperature	Operating: 0 to 55°C Storage: -20 to 75°C (excluding the battery)				
Ambient humidity	Operating: 10% to 90% (with no condensation)				
Ambient atmosphere	Operating: Must be free from corrosive gas				
I/O configuration	Inputs: Connector Outputs: Terminal block	Inputs: Connector Outputs: Connector		Inputs: Connector Outputs: Terminal block	Inputs: Connector Outputs: Connector
Power supply retention time	2 ms min.				

■ CHARACTERISTICS

Item		CPU Boards
		With relay outputs With transistor outputs
Control method		Stored program method
I/O control method		Cyclic scan with direct output; immediate refreshing can be performed with IORF(97)
Programming language		Ladder diagram
Instruction length		1 step per instruction, 1 to 5 words per instruction
Instructions	Basic instructions	14
	Special instructions	105 instructions, 185 variations
Execution time	Basic instructions	0.64 μs (LD instruction)
	Special instructions	7.8 μs (MOV instruction)
Program capacity		4,096 words
Max. I/O capacity	CPU Board only	32 points/40 points
	With Expansion I/O Boards	168 points max.
Input bits		IR 00000 to IR 00915 (words not used for input bits can be used for work bits)
Output bits		IR 01000 to IR 01915 (words not used for output bits can be used for work bits)
Work bits		928 bits: IR 02000 to IR 04915 and IR 20000 to IR 22715
Special bits (SR area)		448 bits: SR 22800 to SR 25515
Temporary bits (TR area)		8 bits (TR0 to TR7)
Holding bits (HR area)		320 bits: HR 0000 to HR 1915 (Words HR 00 to HR 19)
Auxiliary bits (AR area)		384 bits: AR 0000 to AR 2315 (Words AR 00 to AR 23)
Link bits (LR area)		256 bits: LR 0000 to LR 1515 (Words LR 00 to LR 15)
Timers/Counters		256 timers/counters (TIM/CNT 000 to TIM/CNT 255) 1-ms timers: TMHH(—) 10-ms timers: TIMH(15) 100-ms timers: TIM 1-s/10-s timers: TIML(—) Decrementing counters: CNT Reversible counters: CNTR(12)
Data memory	Read/Write	2,048 words (DM 0000 to DM 2047) The Error Log is contained in DM 2000 to DM 2021
	Read-only	456 words (DM 6144 to DM 6599)
	PLC setup	56 words (DM 6600 to DM 6655)
Interrupt processing	External interrupts	4 (also used for external interrupt inputs in counter mode and quick-response inputs)
	Interval timer interrupts	1 (Scheduled Interrupt Mode or Single Interrupt Mode)
High-speed counter	High-speed counter	1 (20 kHz single-phase or 5 kHz two-phase (linear count method))
	Counter interrupt	1 (set value comparison or set-value range comparison)
	Interrupt inputs (Counter mode)	4 inputs (also used for interrupt inputs and quick-response inputs)
	Counter interrupts	4 (also used for the external interrupt inputs and quick-response inputs)
Pulse output		2 points with no acceleration/deceleration, 10 Hz to 10 kHz each, and no direction control 1 point with trapezoidal acceleration/deceleration, 10 Hz to 10 kHz, and direction control 2 points with variable duty-ratio outputs (Pulse outputs can be used with transistor outputs only, they cannot be used with relay outputs)
Synchronized pulse control		1 point: A pulse output can be created by combining the high-speed counter with pulse outputs and multiplying the frequency of the input pulses from the high-speed counter by a fixed factor (This output is possible with transistor outputs only, it cannot be used with relay outputs)
Quick-response inputs		4 points (Min. input pulse width: 50 μs max.) (Also used for interrupt inputs and for interrupt inputs in counter mode)
Input time constant (ON response time = OFF response time)		Can be set for all input points (1 ms, 2 ms, 3 ms, 5 ms, 10 ms, 20 ms, 40 ms, or 80 ms) This constant, however, is fixed to 1 ms for 40 and 64 I/O-point Expansion I/O Boards

(This table continues on the next page.)

Characteristics — continued from previous page

Item	CPU Boards	
	With relay outputs	With transistor outputs
Clock function	Shows the year, month, day of the week, day, hour, minute, and second (Backed up by the battery) (The clock function is available only in CPU Boards equipped with a clock)	
Communications functions	Built-in mini-peripheral port: Supports Host Link, peripheral bus, no-protocol, or Programming Console connections Built-in RS-232C port: Supports Host Link, No-protocol, 1:1 PLC Link (Master/Slave), or 1:1 NT Link connections (RS-232C communications are available only in CPU Boards equipped with an RS-232C port)	
Memory protection (See Notes 1 and 2.)	HR area, AR area, program contents, read/write DM area contents, and counter values maintained during power interruptions	
Memory backup (See Notes 1 and 2.)	Flash memory: Program, read-only DM area, and PLC Setup Battery or capacitor backup: The read/write DM area, HR area, AR area, and counter values are backed up by a battery CPU Boards with clock: Backup is approximately 5 years at 25°C CPU Boards without clock: Backup is approximately 5 days at 25°C	
Self-diagnostic functions	CPU error (watchdog timer), I/O bus error, battery error, and memory error	
Program checks	No END instruction, programming errors (checked when operation is started)	

- Note: 1. The DM area, HR area, AR area, and counter values are backed up by the CPU Board's built-in battery or capacitor. If the battery or capacitor is discharged, the contents of these areas will be lost and the data values will revert to the defaults.
2. The contents of the program area, read-only DM area (DM 6144 to DM 6599), and PLC Setup (DM 6600 to DM 6655) are stored in flash memory. The contents of these areas will be read from flash memory the next time the power is turned ON, even if the backup battery or capacitor is discharged.

When data has been changed in any of these areas, write the new values to flash memory by switching the CPM2B to MONITOR or RUN mode, or by turning the power OFF and then ON again.

■ INPUT SPECIFICATIONS FOR CPU BOARD

Item	Inputs	Specification	Specification
Input voltage	All	24 VDC +10%/-15%	12 VDC +10%/-15%
Input impedance	IN00000 to IN00001	2.7 kΩ	1.5 kΩ
	IN00002 to IN00006	3.9 kΩ	2.0 kΩ
	IN00007 and up	4.7 kΩ	2.4 kΩ
Input current	IN00000 to IN00001	8 mA typical	8 mA typical
	IN00002 to IN00006	6 mA typical	6 mA typical
	IN00007 and up	5 mA typical	5 mA typical
ON voltage/current	IN00000 to IN00001	17 VDC min., 5 mA	9.5 VDC min., 5 mA
	IN00002 and up	14.4 VDC min., 3 mA	8.0 VDC min., 3 mA
OFF voltage/current	All	5.0 VDC max., 1 mA	
ON delay	All	1 to 80 ms max. Default: 10 ms (See Note)	
OFF delay	All	1 to 80 ms max. Default: 10 ms (See Note)	
Circuit configuration	IN00000 to IN00001		
	IN00002 to IN00006		
	IN00007 and up		

- Note: 1. The input time constant can be set to 1, 2, 3, 5, 10, 20, 40, or 80 ms in the PLC Setup.
 2. The value in parentheses shows the resistance for the CPM2B-32C□D1T-D12.

■ INPUT SPECIFICATIONS FOR EXPANSION BOARDS

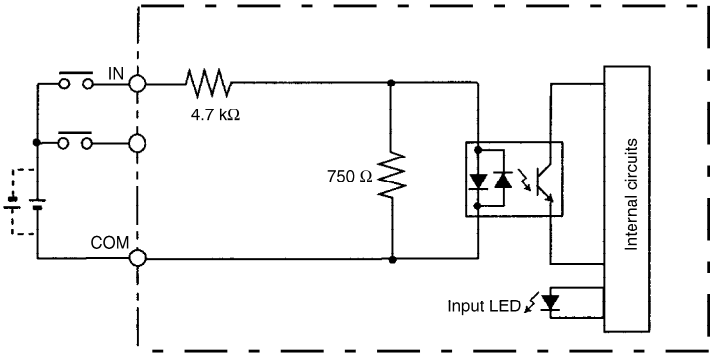
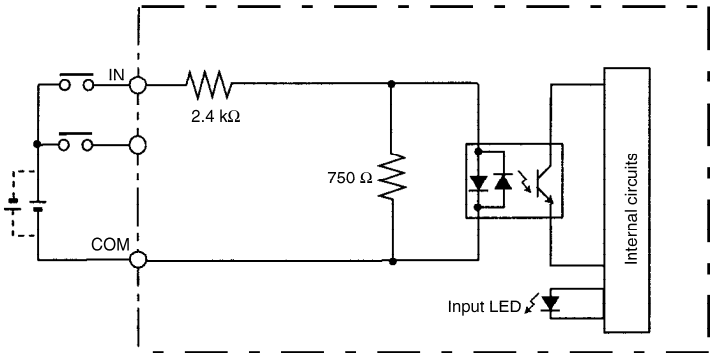
Item	Specification	
	CPM2B-32EDT/32EDR/40EDR/64EDT	CPM2B-32ED1T
Input voltage	24 VDC +10%/-15%	12 VDC +10%/-15%
Input impedance	4.7 kΩ	2.4 kΩ
Input current	5 mA typical	5 mA typical
ON voltage	14.4 VDC min.	8.0 VDC, 3 mA min.
OFF voltage	5.0 VDC max.	3.0 VDC, 1 mA max.
ON delay	1 to 80 ms max. Default: 10 ms (See Note)	
OFF delay	1 to 80 ms max. Default: 10 ms (See Note)	
Circuit configuration	<p>CPM2B-32EDT/32EDR/40EDR/64EDT</p>  <p>CPM2B-32ED1T</p> 	

Note: The input time constant can be set to 1, 2, 3, 5, 10, 20, 40, or 80 ms in the PLC Setup. (The constant, however, is fixed to 1 ms for 40 and 64 I/O-point Expansion I/O Boards.)

Max. Number of Inputs Simultaneously ON

The maximum number of inputs that can be ON simultaneously depends upon the ambient operating temperature and the installation orientation, as shown in the following diagrams.

Installation orientation: Vertical with edge down

All inputs can be ON simultaneously with this orientation.

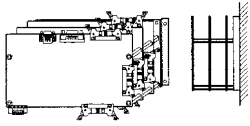

Installation orientation: Vertical with end down

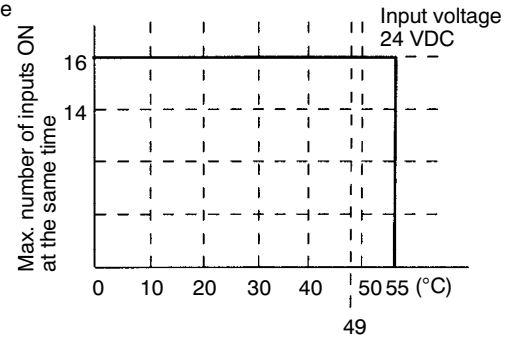
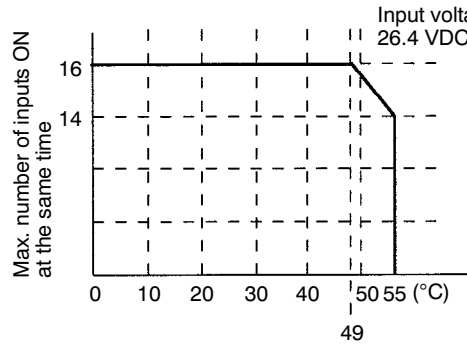
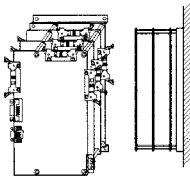

Installation orientation: Horizontal

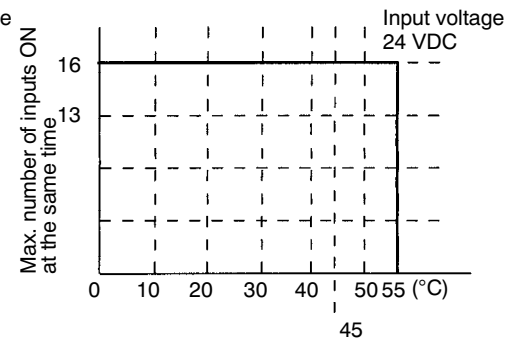
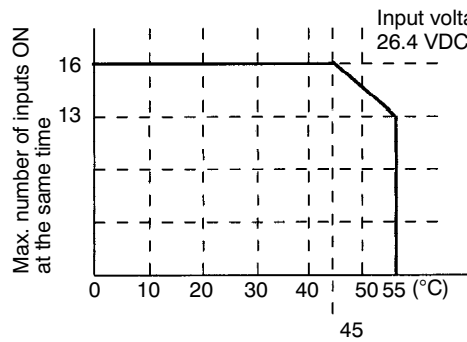

■ HIGH-SPEED COUNTER INPUTS

Inputs IN00000 through IN00002 can be used as high-speed counter inputs, as shown in the following table. The maximum count frequency is 5 kHz in differential phase mode and 20 kHz in the other modes.

Input	Function			
	Differential phase mode	Pulse plus direction input mode	Up/down input mode	Increment mode
IN00000	A-phase pulse input	Pulse input	Increment pulse input	Increment pulse input
IN00001	B-phase pulse input	Direction input	Decrement pulse input	Normal input
IN00002	Z-phase pulse input or hardware reset input (IN00002 can be used as a normal input when it is not used as a high-speed counter input.)			

The minimum pulse widths for inputs IN00000 (A-phase input) and IN00001 (B-phase input) are as follows:

Pulse plus direction input mode, Up/down input mode, Increment mode

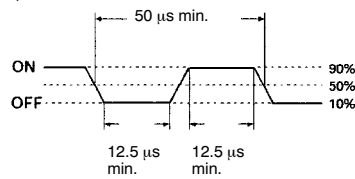

Differential phase mode

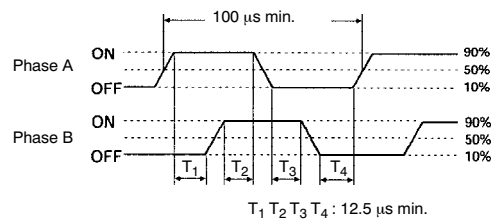

The minimum pulse width for input IN00002 (Z-phase input) is as follows:

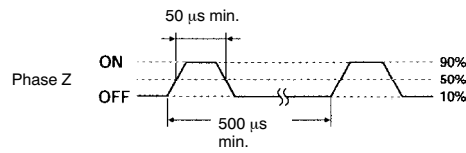

■ INTERRUPT INPUTS

Inputs IN00003 through IN00006 can be used as interrupt inputs (interrupt input mode or counter mode) and quick-response inputs. The minimum pulse width for these inputs is 50 μ s.

Expansion I/O Board Input Specifications

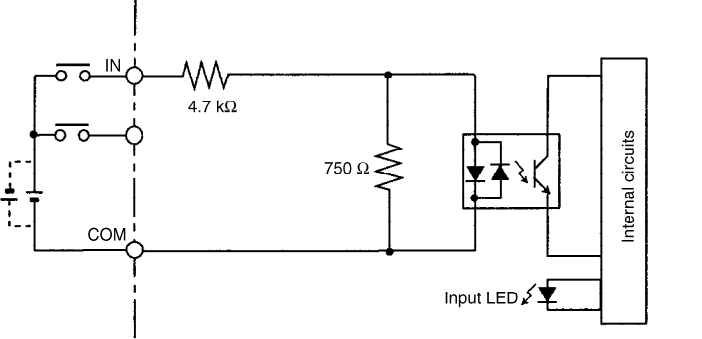
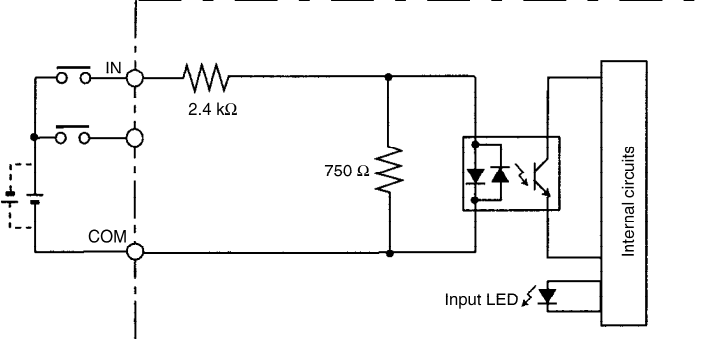
Item	Specification	
	CPM2B-32EDT/32EDR/40EDR/64EDT	CPM2B-32ED1T
Input voltage	24 VDC $+10\%/ -15\%$	12 VDC $+10%/ -15\%$
Input impedance	4.7 k Ω	2.4 k Ω
Input current	5 mA typical	5 mA typical
ON voltage	14.4 VDC min.	8.0 VDC min., 3mA min.
OFF voltage	5.0 VDC max.	3.0 VDC max., 1 mA max.
ON delay	1 to 80 ms max. Default: 10 ms (See Note)	
OFF delay	1 to 80 ms max. Default: 10 ms (See Note)	
Circuit configuration	<p>CPM2B-32EDT/32EDR/40EDR/64EDT</p>  <p>CPM2B-32ED1T</p> 	

Note: The input time constant can be set to 1, 2, 3, 5, 10, 20, 40, or 80 ms in the PLC Setup. (The constant, however, is fixed to 1 ms for 40 and 64 I/O-point Expansion I/O Boards.)

■ OUTPUT SPECIFICATIONS FOR CPU BOARD AND EXPANSION I/O BOARD

Relay Outputs

Item	Specification
Max. switching capacity	2 A, 250 VAC ($\cos\phi = 1$) 2 A, 24 VDC (4 A/common)
Min. switching capacity	10 mA, 5 VDC
Service life of relay (See Note)	Electrical: 150,000 operations (24 VDC resistive load) 100,000 operations (240 VAC inductive load, $\cos\phi = 0.4$) Mechanical: 20,000,000 operations
ON delay	15 ms max.
OFF delay	15 ms max.
Circuit configuration	

Note: The service life of the CPM2B's relay output contacts shown in the table assumes the worst conditions. The following graph shows the results of OMRON's service life tests at a switching rate of 1,800 times/hour.

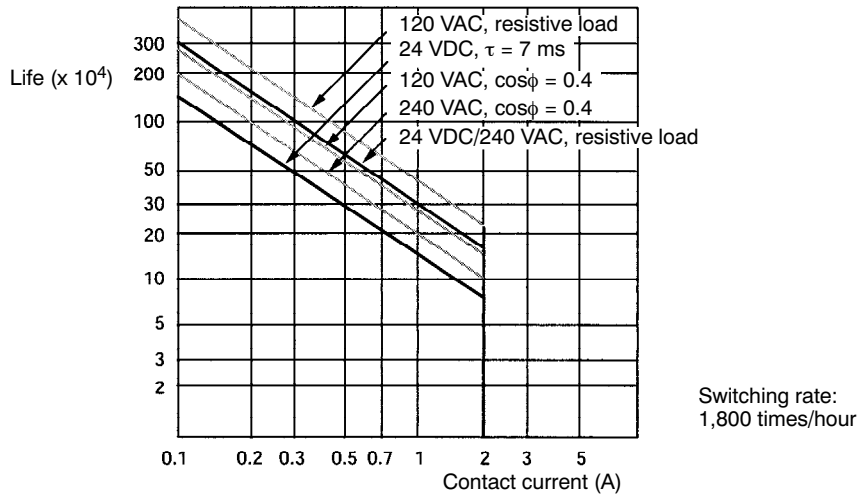

Transistor Outputs (NPN or PNP)

Item	Specification
Max. switching capacity	OUT01000 and OUT01001: 4.5 to 30 VDC, 0.2 A/output (See Note) OUT01002 and up: 4.5 to 30 VDC, 0.3 A/output (See Note)
Leakage current	0.1 mA max.
Residual voltage	1.5 V max.
ON delay	OUT01000 and OUT01001: 20 μ s max. OUT01002 and up: 0.1 ms max.
OFF delay	OUT01000 and OUT01001: 40 μ s max. for 4.5 to 26.4 V, 10 to 100 mA 0.1 ms max. for 4.5 to 30 V, 10 to 200 mA OUT01002 and up: 1 ms max. for 4.5 to 30 V, 10 to 300 mA
Fuse	1 fuse/output (cannot be replaced by user)
Circuit configuration	<p>Sinking Outputs</p>

Note: When using OUT01000 or OUT01001 for pulse outputs, connect a dummy resistor as required to bring the load current between 0.01 and 0.1 A. If the load current is below 0.01 A, the ON-to-OFF response time will be too long and high-speed pulses will not be output.

Dimensions

Unit: mm (inch)

■ CPU AND EXPANSION I/O BOARDS

CPM2B-32C□D□-D 32-point Models

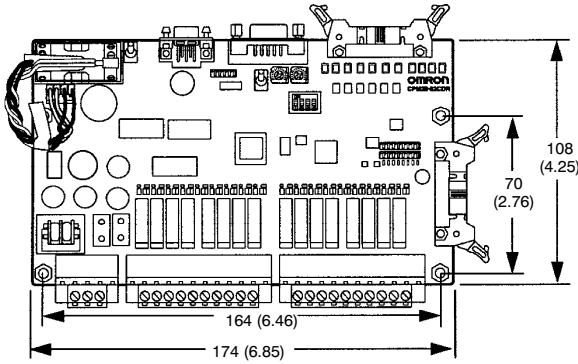

CPM2B-40C2DR-D 40-point Models

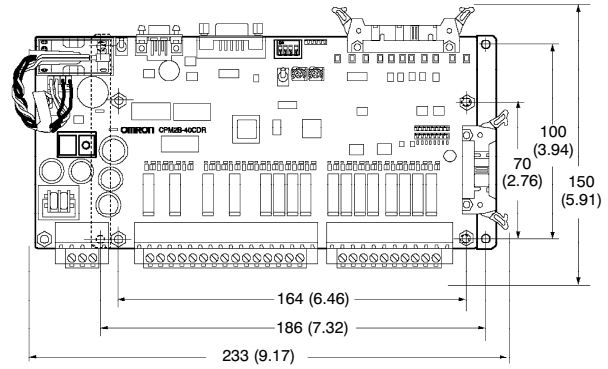

CPM2B-32ED 32-point Models

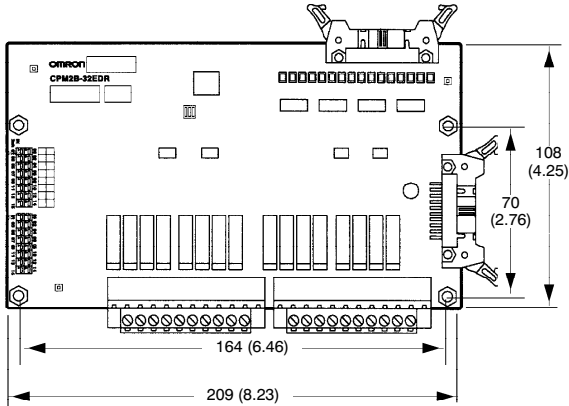

CPM2B-40EDR 40-point Models

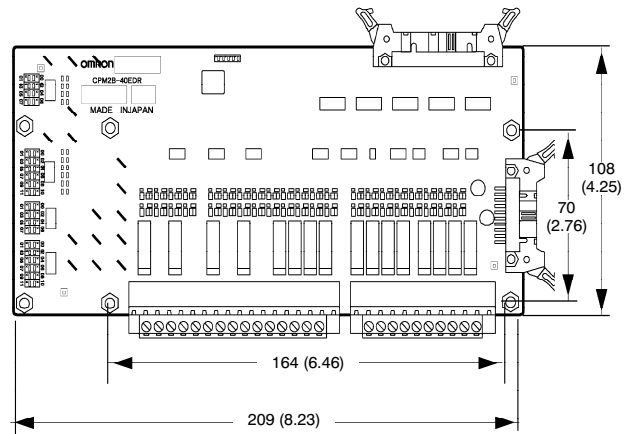

CPM2B-64EDT 64-point Models

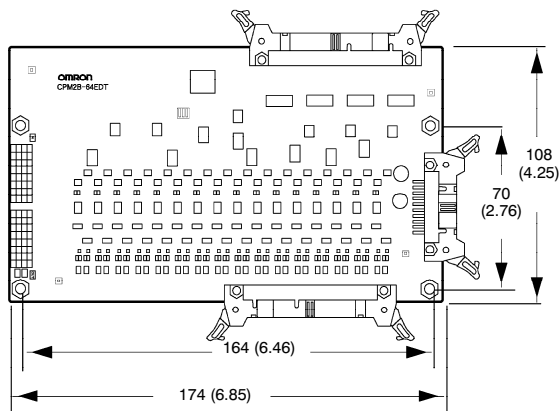

CPM2B-MAD□□ Analog I/O Boards

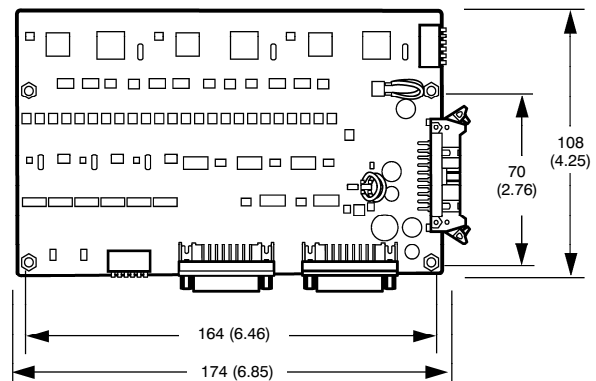

■ MOUNTING BRACKET

CPM2B-ATT01 Mounting Bracket

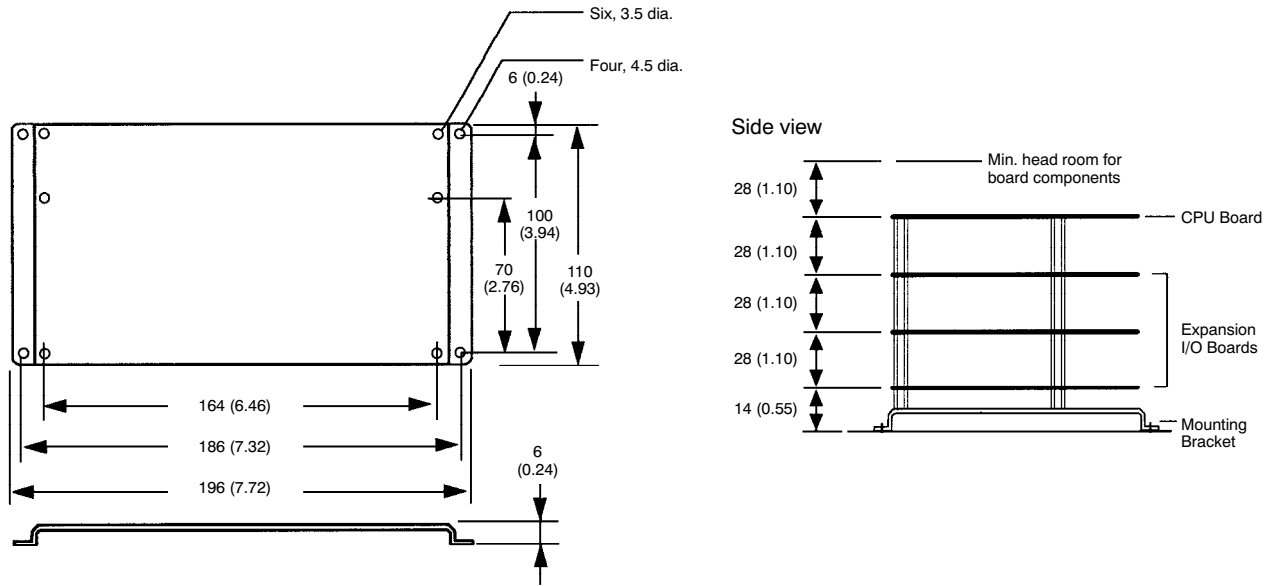

■ WEIGHT

Name	Model	Weight	
CPU Board	24 VDC	CPM2B-32C1DR-D	233 g max.
		CPM2B-32C2DR-D	260 g max.
		CPM2B-32C1DT-D	150 g max.
		CPM2B-32C2DT-D	178 g max.
		CPM2B-40C2DR-D	294 g max.
	12 VDC	CPM2B-32C1DT1-D12	150 g max.
CPM2B-32C2DT1-D12		178 g max.	
Expansion I/O Board	CPM2B-32EDR	199 g max.	
	CPM2B-32EDT/32ED1T	115 g max.	
	CPM2B-40EDR	239 g max.	
	CPM2B-64EDT	166 g max.	
Analog I/O Board	CPM2B-MAD□□	160 g max.	

Functions

■ CONFIGURATION

The CPM2B programmable controller system has both CPU boards and Expansion I/O boards that provide the functionality of block-style controllers. Capabilities include synchronized pulse control, interrupt inputs, pulse outputs, serial communications and real-time clock functions. In many applications, the CPM2B controller can be a cost-effective alternative to custom-designed embedded control boards.

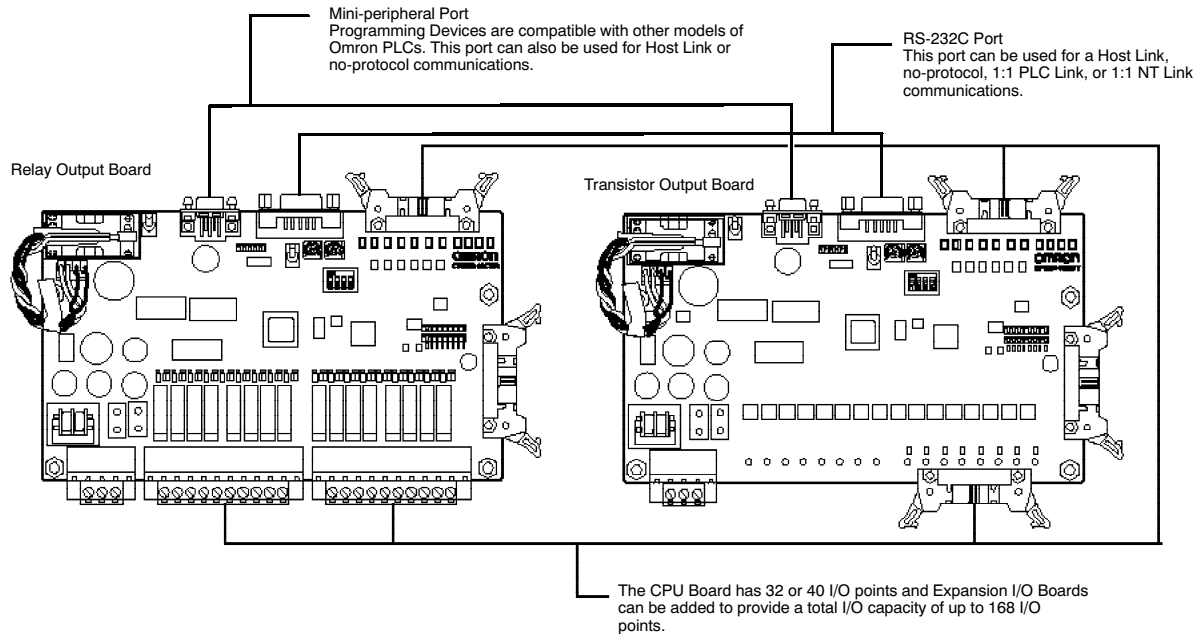

■ BUILT-IN MOTOR CONTROL CAPABILITIES

Synchronized Pulse Control

(Transistor Outputs Only)

Synchronized pulse control provides an easy way to synchronize the operation of a peripheral piece of equipment with the main equipment. The output pulse frequency can be controlled as some multiple of the input pulse frequency, allowing the speed of the peripheral piece of equipment (such as a supply conveyor) to be synchronized with the speed of the main piece of equipment.

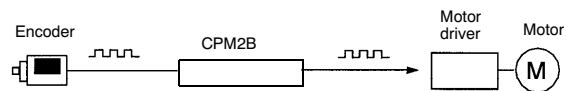

Pulses are output as a fixed multiple of the input frequency.

High-speed Counters and Interrupts

The CPM2B has a total of five high-speed counter inputs. The one high-speed counter input has a response frequency of 20 kHz/5kHz and the four interrupt inputs in counter mode have response frequency of 2 kHz.

The high-speed counter can be used in any one of the four input modes: differential phase mode (5 kHz), pulse plus direction input mode (20 kHz), up/down pulse mode (20 kHz), or increment mode (20 kHz). Interrupts can be triggered when the count matches a set value or falls within a specific range.

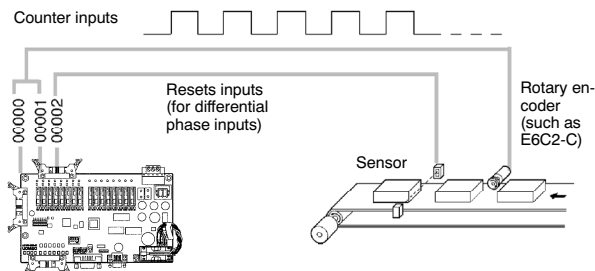

The interrupt inputs in counter mode can be used for incrementing counters or decrementing counters (2 kHz) and trigger an interrupt (executing the interrupt program) when the count matches the target value.

Input	Response frequency	Input mode (count value)	Control method
00000 00001 00002	5 kHz	Differential phase input mode (-8,388,608 to 8,388,607)	Target value comparison interrupts
	20 kHz	Pulse + direction input mode (-8,388,608 to 8,388,607) Up/down pulse input mode (-8,388,608 to 8,388,607) Increment mode (0 to 16,777,215)	Range comparison interrupts

Position Control with Pulse Outputs

(Transistor Output Models Only)

The CPM2B PLCs with transistor outputs have two outputs that can produce 10 Hz to 10 kHz pulses (single-phase outputs).

When used as single-phase pulse outputs, there can be two outputs with a frequency range of 10 Hz to 10 kHz with a fixed duty ratio or 0.1 to 999.9 Hz with a variable duty ration (0 to 100% duty ratio).

When used as pulse plus direction or up/down pulse outputs, there can be just one output with a frequency range of 10 Hz to 10 kHz.

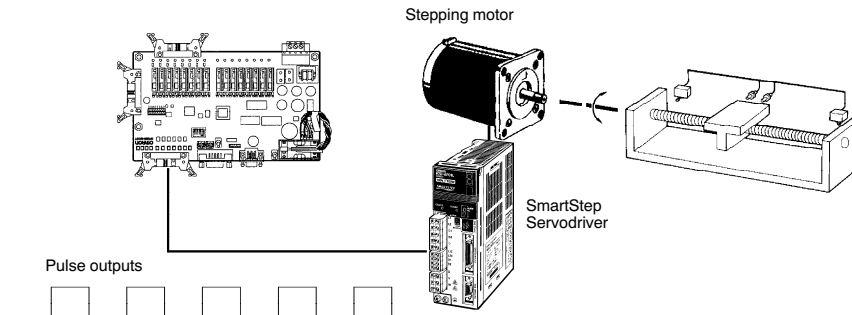

Item	Single-phase pulse output without accel/decel	Variable duty-ratio pulse output	Single-phase pulse output with trapezoidal acceleration/deceleration				
			Pulse + direction output		Up/down pulse output		
Controlling instruction(s)	PULS(65) and SPED(64)	PWM(--)	PULS(65) and ACC(--)				
Output number	01000	Pulse output 0 (See Note)	Pulse output 0 (See Note)	Pulse output 0	Pulse output	Pulse output 0	CW pulse output
	01001	Pulse output 1 (See Note)	Pulse output 1 (See Note)		Direction output		CCW pulse output
Output frequency range	10 Hz to 10 kHz	0.1 Hz to 999.9 Hz	10 Hz to 10 kHz		10 Hz to 10 kHz		
	Pitch	10 Hz	0.1 Hz	10 Hz	10 Hz		
Duty ratio	50%	0 to 100%	50%		50%		

Note: With single-phase pulse outputs, pulse outputs 0 and 1 can each be output independently.

■ HIGH-SPEED INPUT CAPABILITIES FOR MACHINE CONTROL

High-speed Interrupt Input Function

There are four inputs used for interrupt inputs (shared with quick-response inputs and interrupt inputs in counter mode) with a minimum input signal width of 50 μ s and response time of 0.3 ms. When an interrupt input goes ON, the main program is stopped and the interrupt program is executed.

Quick-response Input Function

There are four inputs used for quick-response inputs (shared with interrupt inputs and interrupt inputs in counter mode) that can reliably read input signals with a signal width as short as 50 μ s.

Stabilizing Input Filter Function

The input time constant for all inputs can be set to 1 ms, 2 ms, 3 ms, 5 ms, 10 ms, 20 ms, 40 ms, or 80 ms. The effects of chattering and external noise can be reduced by increasing the input time constant.

■ OTHER CONVENIENCE FUNCTIONS

Interval Timer Interrupts

The interval timer can be set between 0.5 and 319,968 ms and can be set to generate just one interrupt (one-shot mode) or periodic interrupts (scheduled interrupt mode).

Analog Settings

There are two controls on the CPU Board that can be turned to change the analog settings (0 to 200 BCD) in IR 250 and IR 251. These controls can be used to easily change or fine-tune machine settings such as a conveyor belt's pause time or feed rate.

DIP Switch Inputs

A DIP switch is provided that controls the status of four input bits.

Calendar/Clock

The built-in clock (accuracy within 1 minute/month) can be read from the program to show the current year, month, day, day of the week, and time. The clock can be set from a Programming Devices (such as a Programming Console) or the time can be adjusted by rounding up or down to the nearest minute.

Long-term Timer

TIML (—) is a long-term timer that accommodates set values up to 99,990 seconds (27 hours, 46 minutes, 30 seconds). When combined with the SECONDS TO HOURS conversion instruction HMS (—), the long-term timer provides an easy way to control equipment scheduling.

■ ANALOG I/O CONTROL CAPABILITIES

A CPU Board with a 24 VDC power supply can be connected with up to three Analog I/O Boards, to which external analog I/O devices can be connected using up to eight inputs and four outputs.

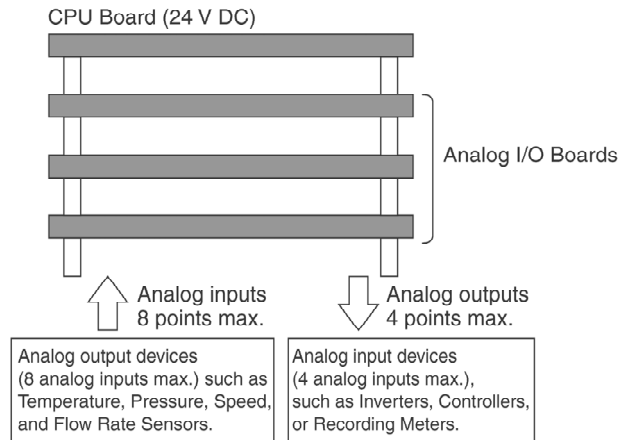

Select the Analog I/O Boards that are appropriate for the system being used from the following three models.

Model	Number of inputs	Number of outputs	Maximum number of connectable units
CPM2B-MAD63	6 points	3 points	1
CPM2B-MAD42	4 points	2 points	2
CPM2B-MAD21	2 points	1 points	3

(If two CPM2B-MAD42 Analog I/O Boards are connected, there will be 8 inputs and 4 outputs.)

Analog I/O signals correspond to various voltage/current signals, enabling connection of various analog devices.

Input signal ranges	Output signal ranges	Resolution
0 to 5 V, 1 to 5 V, 0 to 10 V, -10 to 10 V, 0 to 20 mA, and 4 to 20 mA	1 to 5 V, 0 to 10 V, -10 to 10 V, 0 to 20 mA, and 4 to 20 mA	6,000 (full scale)

If input signals are subject to minute fluctuations, average processing can be used to read the input signals as a stable signal. Average processing can be set separately for each input using the DIP switch.

When analog inputs are used in the range of 1 to 5 V or 4 to 20 mA, line disconnection detection will function. When the input signal level recovers, the line disconnection status is automatically cleared.

Communications

■ NT LINK

In a 1:1 NT Link, an Omron NT-series Programmable Terminal can be connected directly to the CPM2B for real time display of process values. The Programmable Terminal must be connected to the RS-232C port; it cannot be connected to the Peripheral port.

Using Host Link communications, an Omron NT-series Programmable Terminal can be connected to CPM2B at either the RS-232C or Peripheral port using the adapters shown below.

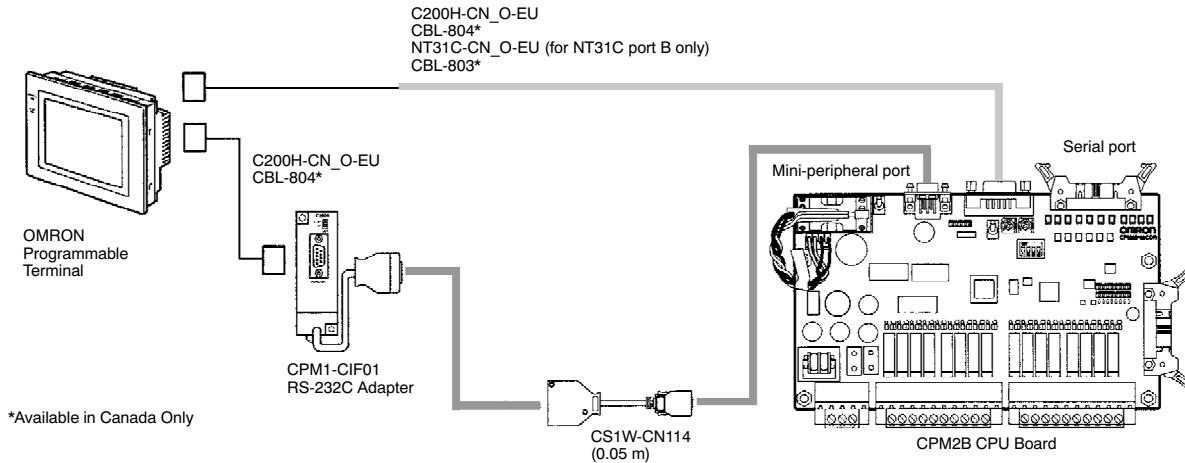

■ HOST LINK

A Host Link connection can be made through the PLC's RS-232C port or peripheral port. A personal computer or Programmable Terminal connected in Host Link mode can be used for operations such as reading/writing data in the PLC's I/O memory or reading/changing PLC's operating mode.

1:1 Host Link Communications

RS-232C Port Connection

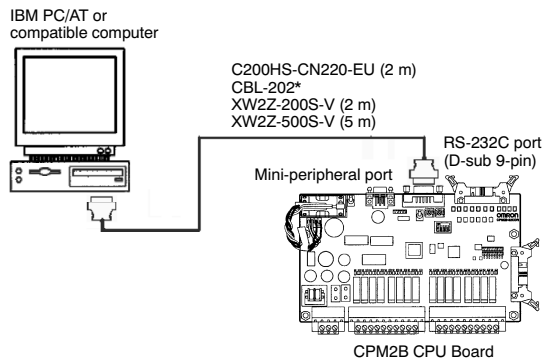

Mini-peripheral Port Connection

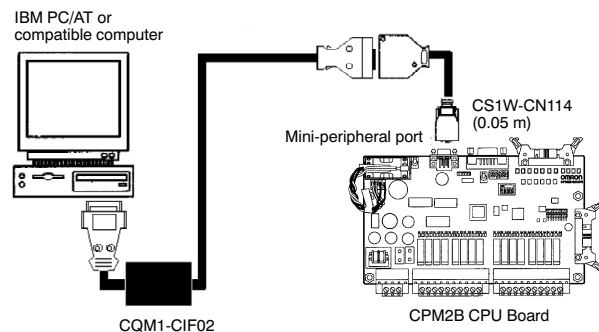

Peripheral Port Connection

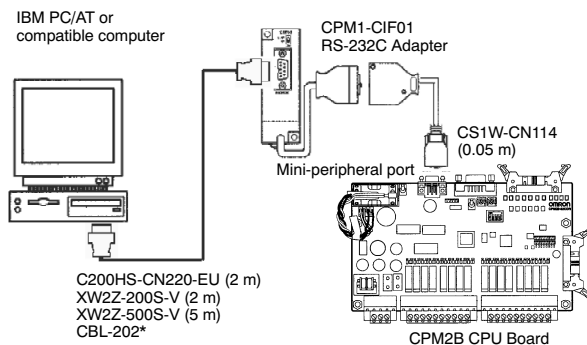

*Available in Canada Only

1:N Host Link communications

Up to 32 Omron programmable controllers, including, CPM2B, can be connected to a host computer.

Using the Peripheral Port

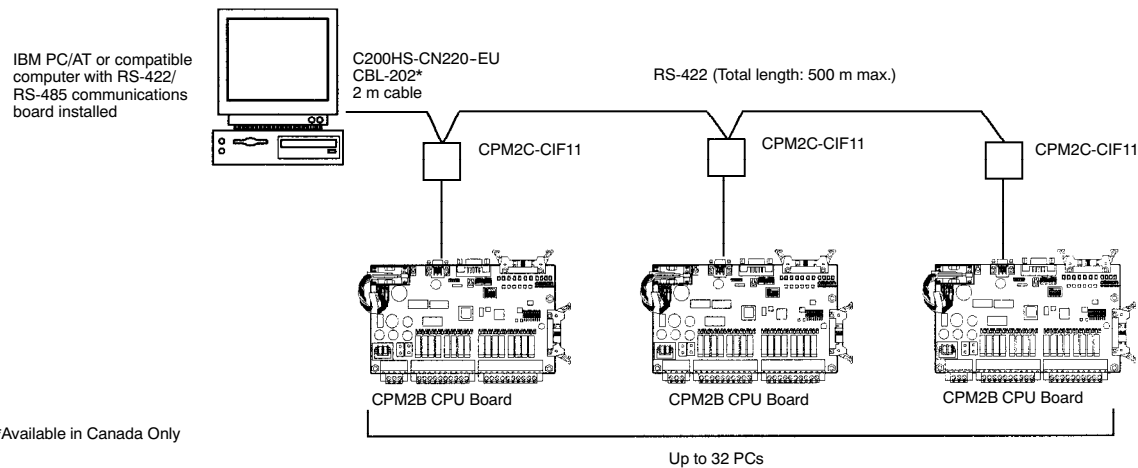

Note: Only one port on the CPM2C-CIF11 may be used. The adapter receives +5 VDC from the peripheral port.

■ NO-PROTOCOL COMMUNICATIONS

The transmit data TXD (48) and receive data RXD (47) instructions can be used in no-protocol mode to exchange data with standard serial devices. For example, data can be received from a bar code reader or transmitted to a serial modem. The serial devices can be connected directly to the RS-232C port or via the Peripheral port using a communication adapter (CPM2C-CIF01 or CIF11).

Inputting data from a bar code reader

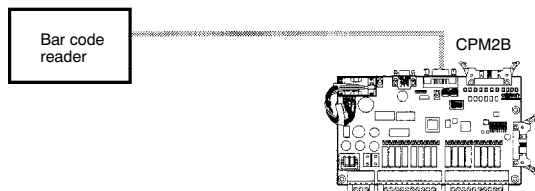

Outputting data to a serial modem

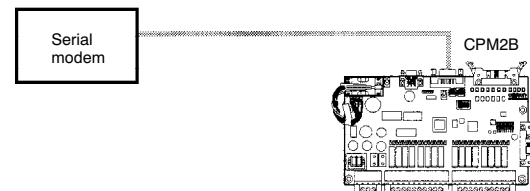

1:1 DATA LINKS

A CPM2B can be linked directly to another CPM2B, CQM1, CPM1, CPM1A, CPM2A, CPM2C, SRM1(-V2), C200HS or C200HX/HG/HE PLC. The 1:1 PLC Link allows automatic data link connections. The PLC's must be connected through the RS-232C ports; they cannot be connected through the Mini-peripheral ports.

1:1 Link Master

1:1 Link Slave

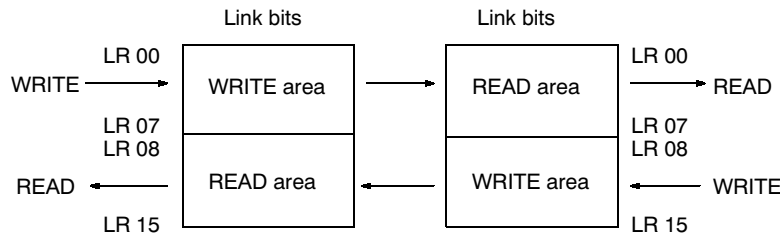
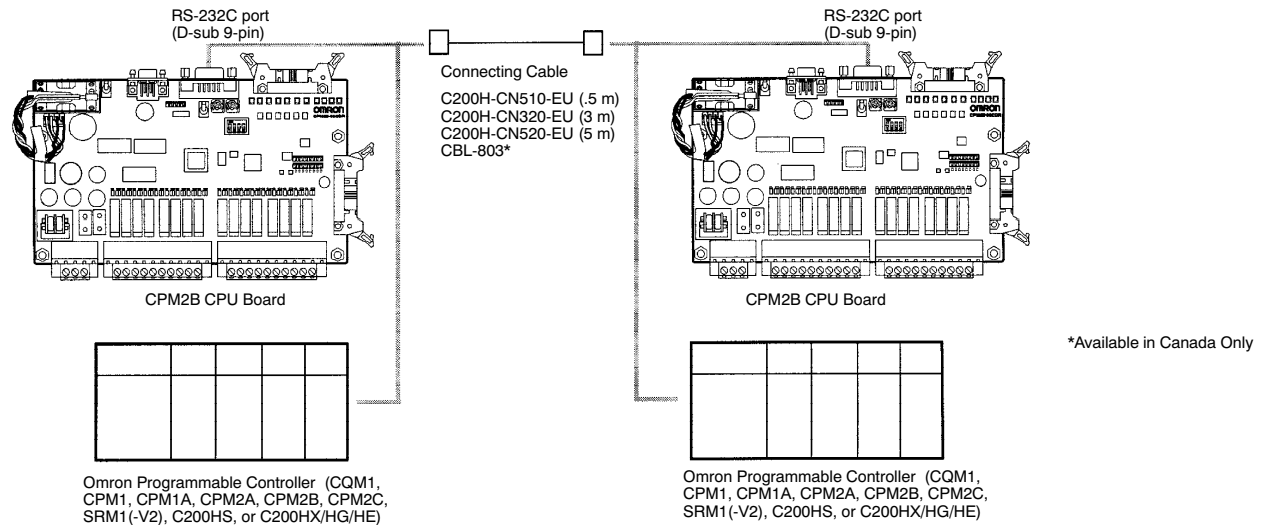

PROGRAM TRANSFER UNIT

Use Omron's EEPROM program transfer unit to update programs in machines or program multiple controllers with the same program.

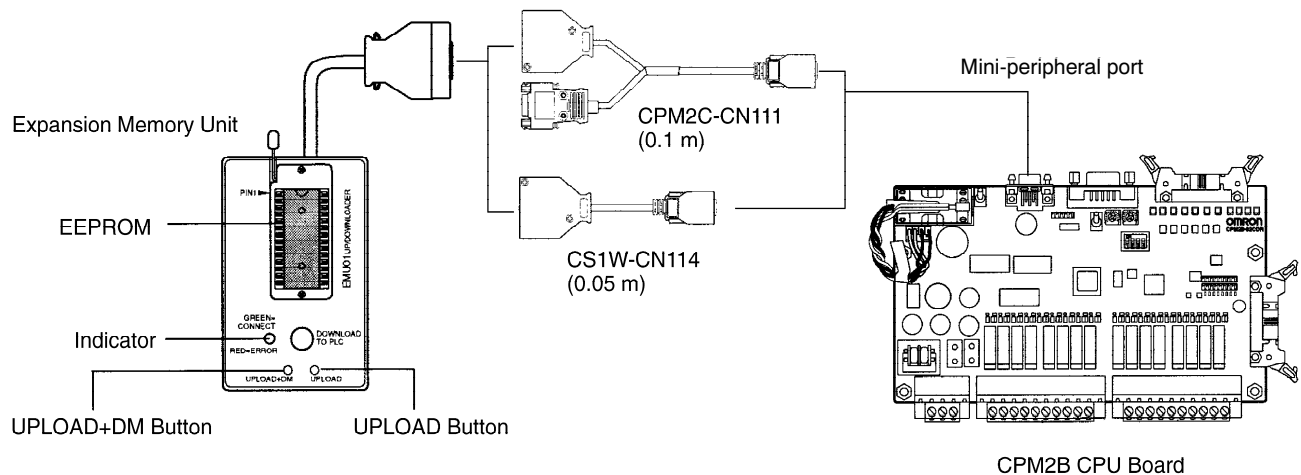

Certain Terms and Conditions of Sale

1. **Offer; Acceptance.** These terms and conditions (these "Terms") are deemed part of all catalogs, manuals or other documents, whether electronic or in writing, relating to the sale of goods or services (collectively, the "Goods") by Omron Electronics LLC and its subsidiary companies ("Seller"). Seller hereby objects to any terms or conditions proposed in Buyer's purchase order or other documents which are inconsistent with, or in addition to, these Terms. Please contact your Omron representative to confirm any additional terms for sales from your Omron company.
2. **Prices.** All prices stated are current, subject to change without notice by Seller. Buyer agrees to pay the price in effect at time of shipment.
3. **Discounts.** Cash discounts, if any, will apply only on the net amount of invoices sent to Buyer after deducting transportation charges, taxes and duties, and will be allowed only if (i) the invoice is paid according to Seller's payment terms and (ii) Buyer has no past due amounts owing to Seller.
4. **Orders.** Seller will accept no order less than \$200 net billing.
5. **Governmental Approvals.** Buyer shall be responsible for, and shall bear all costs involved in, obtaining any government approvals required for the importation or sale of the Goods.
6. **Taxes.** All taxes, duties and other governmental charges (other than general real property and income taxes), including any interest or penalties thereon, imposed directly or indirectly on Seller or required to be collected directly or indirectly by Seller for the manufacture, production, sale, delivery, importation, consumption or use of the Goods sold hereunder (including customs duties and sales, excise, use, turnover and license taxes) shall be charged to and remitted by Buyer to Seller.
7. **Financial.** If the financial position of Buyer at any time becomes unsatisfactory to Seller, Seller reserves the right to stop shipments or require satisfactory security or payment in advance. If Buyer fails to make payment or otherwise comply with these Terms or any related agreement, Seller may (without liability and in addition to other remedies) cancel any unshipped portion of Goods sold hereunder and stop any Goods in transit until Buyer pays all amounts, including amounts payable hereunder, whether or not then due, which are owing to it by Buyer. Buyer shall in any event remain liable for all unpaid accounts.
8. **Cancellation; Etc.** Orders are not subject to rescheduling or cancellation unless Buyer indemnifies Seller fully against all costs or expenses arising in connection therewith.
9. **Force Majeure.** Seller shall not be liable for any delay or failure in delivery resulting from causes beyond its control, including earthquakes, fires, floods, strikes or other labor disputes, shortage of labor or materials, accidents to machinery, acts of sabotage, riots, delay in or lack of transportation or the requirements of any government authority.
10. **Shipping; Delivery.** Unless otherwise expressly agreed in writing by Seller:
 - a. Shipments shall be by a carrier selected by Seller;
 - b. Such carrier shall act as the agent of Buyer and delivery to such carrier shall constitute delivery to Buyer;
 - c. All sales and shipments of Goods shall be FOB shipping point (unless otherwise stated in writing by Seller), at which point title to and all risk of loss of the Goods shall pass from Seller to Buyer, provided that Seller shall retain a security interest in the Goods until the full purchase price is paid by Buyer;
 - d. Delivery and shipping dates are estimates only.
 - e. Seller will package Goods as it deems proper for protection against normal handling and extra charges apply to special conditions.
11. **Claims.** Any claim by Buyer against Seller for shortage or damage to the Goods occurring before delivery to the carrier must be presented in writing to Seller within 30 days of receipt of shipment and include the original transportation bill signed by the carrier noting that the carrier received the Goods from Seller in the condition claimed.
12. **Warranties.** (a) **Exclusive Warranty.** Seller's exclusive warranty is that the Goods will be free from defects in materials and workmanship for a period of twelve months from the date of sale by Seller (or such other period expressed in writing by Seller). Seller disclaims all other warranties, express or implied. (b) **Limitations.** SELLER MAKES NO WARRANTY OR REPRESENTATION, EXPRESS OR IMPLIED, ABOUT NON-INFRINGEMENT, MERCHANTABILITY OR FITNESS FOR A PARTICULAR PURPOSE OF THE GOODS. BUYER ACKNOWLEDGES THAT IT ALONE HAS DETERMINED THAT THE GOODS WILL SUITABLY MEET THE REQUIREMENTS OF THEIR INTENDED USE. Seller further disclaims all warranties and responsibility of any type for claims or expenses based on infringement by the Goods or otherwise of any intellectual property right. (c) **Buyer Remedy.** Seller's sole obligation hereunder shall be to replace (in the form originally shipped with Buyer responsible for labor charges for removal or replacement thereof) the non-complying Good or, at Seller's election, to repay or credit Buyer an amount equal to the purchase price of the Good; provided that in no event shall Seller be responsible for warranty, repair, indemnity or any other claims or expenses regarding the Goods unless Seller's analysis confirms that the Goods were properly handled, stored, installed and maintained and not subject to contamination, abuse, misuse or inappropriate modification. Return of any goods by Buyer must be approved in writing by Seller before shipment. Seller shall not be liable for the suitability or unsuitability or the results from the use of Goods in combination with any electrical or electronic components, circuits, system assemblies or any other materials or substances or environments. Any advice, recommendations or information given orally or in writing, are not to be construed as an amendment or addition to the above warranty.
13. **Damage Limits; Etc.** SELLER SHALL NOT BE LIABLE FOR SPECIAL, INDIRECT OR CONSEQUENTIAL DAMAGES, LOSS OF PROFITS OR PRODUCTION OR COMMERCIAL LOSS IN ANY WAY CONNECTED WITH THE GOODS, WHETHER SUCH CLAIM IS BASED IN CONTRACT, WARRANTY, NEGLIGENCE OR STRICT LIABILITY. Further, in no event shall liability of Seller exceed the individual price of the Good on which liability is asserted.
14. **Indemnities.** Buyer shall indemnify and hold harmless Seller, its affiliates and its employees from and against all liabilities, losses, claims, costs and expenses (including attorney's fees and expenses) related to any claim, investigation, litigation or proceeding (whether or not Seller is a party) which arises or is alleged to arise from Buyer's acts or omissions under these Terms or in any way with respect to the Goods. Without limiting the foregoing, Buyer (at its own expense) shall indemnify and hold harmless Seller and defend or settle any action brought against Seller to the extent that it is based on a claim that any Good made to Buyer specifications infringed intellectual property rights of another party.
15. **Property; Confidentiality.** The intellectual property embodied in the Goods is the exclusive property of Seller and its affiliates and Buyer shall not attempt to duplicate it in any way without the written permission of Seller. Notwithstanding any charges to Buyer for engineering or tooling, all engineering and tooling shall remain the exclusive property of Seller. All information and materials supplied by Seller to Buyer relating to the Goods are confidential and proprietary, and Buyer shall limit distribution thereof to its trusted employees and strictly prevent disclosure to any third party.
16. **Miscellaneous.** (a) **Waiver.** No failure or delay by Seller in exercising any right and no course of dealing between Buyer and Seller shall operate as a waiver of rights by Seller. (b) **Assignment.** Buyer may not assign its rights hereunder without Seller's written consent. (c) **Amendment.** These Terms constitute the entire agreement between Buyer and Seller relating to the Goods, and no provision may be changed or waived unless in writing signed by the parties. (d) **Severability.** If any provision hereof is rendered ineffective or invalid, such provision shall not invalidate any other provision. (e) **Setoff.** Buyer shall have no right to set off any amounts against the amount owing in respect of this invoice. (f) As used herein, "including" means "including without limitation".

Certain Precautions on Specifications and Use

1. **Suitability of Use.** Seller shall not be responsible for conformity with any standards, codes or regulations which apply to the combination of the Good in the Buyer's application or use of the Good. At Buyer's request, Seller will provide applicable third party certification documents identifying ratings and limitations of use which apply to the Good. This information by itself is not sufficient for a complete determination of the suitability of the Good in combination with the end product, machine, system, or other application or use. The following are some examples of applications for which particular attention must be given. This is not intended to be an exhaustive list of all possible uses of this Good, nor is it intended to imply that the uses listed may be suitable for this Good:
 - (i) Outdoor use, uses involving potential chemical contamination or electrical interference, or conditions or uses not described in this document.
 - (ii) Energy control systems, combustion systems, railroad systems, aviation systems, medical equipment, amusement machines, vehicles, safety equipment, and installations subject to separate industry or government regulations.
 - (iii) Systems, machines and equipment that could present a risk to life or property. Please know and observe all prohibitions of use applicable to this Good.
2. **Programmable Products.** Seller shall not be responsible for the user's programming of a programmable Good, or any consequence thereof.
3. **Performance Data.** Performance data given in this catalog is provided as a guide for the user in determining suitability and does not constitute a warranty. It may represent the result of Seller's test conditions, and the user must correlate it to actual application requirements. Actual performance is subject to the Seller's Warranty and Limitations of Liability.
4. **Change in Specifications.** Product specifications and accessories may be changed at any time based on improvements and other reasons. It is our practice to change part numbers when published ratings or features are changed, or when significant construction changes are made. However, some specifications of the Good may be changed without any notice. When in doubt, special part numbers may be assigned to fix or establish key specifications for your application. Please consult with your Seller's representative at any time to confirm actual specifications of purchased Good.
5. **Errors and Omissions.** The information in this catalog has been carefully checked and is believed to be accurate; however, no responsibility is assumed for clerical, typographical or proofreading errors, or omissions.

NEVER USE THE PRODUCT FOR AN APPLICATION INVOLVING SERIOUS RISK TO LIFE OR PROPERTY WITHOUT ENSURING THAT THE SYSTEM AS A WHOLE HAS BEEN DESIGNED TO ADDRESS THE RISKS, AND THAT THE SELLER'S PRODUCT IS PROPERLY RATED AND INSTALLED FOR THE INTENDED USE WITHIN THE OVERALL EQUIPMENT OR SYSTEM.

Complete “Terms and Conditions of Sale” for product purchase and use are on Omron’s website at www.omron.com/oei – under the “About Us” tab, in the Legal Matters section.

ALL DIMENSIONS SHOWN ARE IN MILLIMETERS.

To convert millimeters into inches, multiply by 0.03937. To convert grams into ounces, multiply by 0.03527.

OMRON[®]**OMRON ELECTRONICS LLC**

One Commerce Drive
Schaumburg, IL 60173

847-843-7900

For US technical support or other inquiries:

800-556-6766**OMRON CANADA, INC.**

885 Milner Avenue
Toronto, Ontario M1B 5V8

416-286-6465**OMRON ON-LINE**

Global - <http://www.omron.com>

USA - <http://www.omron.com/oei>

Canada - <http://www.omron.ca>