

MK2 Series

MEDER electronic

Ferromagnetic Metal
Detection Sensors

DESCRIPTION

These reed proximity switches operate when in the presence of magnetically conductive material. Instead of an actuating magnet, only a simple piece of iron is required to operate the sensor from the front or from above. The standard cable is UL listed and is round twin core 2 x 0.35 mm² (AWG22).



APPLICATIONS

- Industrial applications
- End travel sensing limit switch in pneumatic cylinders
- Position control
- Control functions in plant and utility vehicles
- Security applications
- Door and window control
- Opening recognition contact
- Fire protection doors

FEATURES

- Form A and B are available
- High power switches available
- Other cables, connectors and colors available
- A choice of cable terminations and lengths are available

DIMENSIONS

All dimensions in mm [inches]

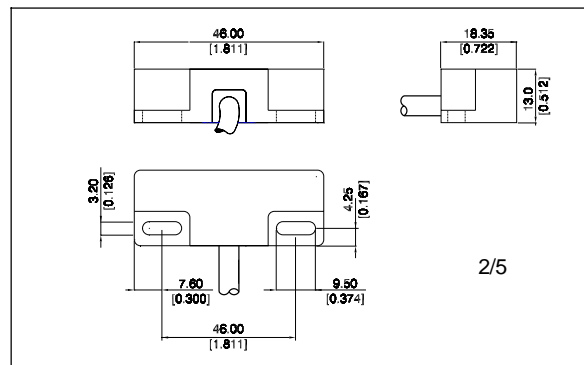
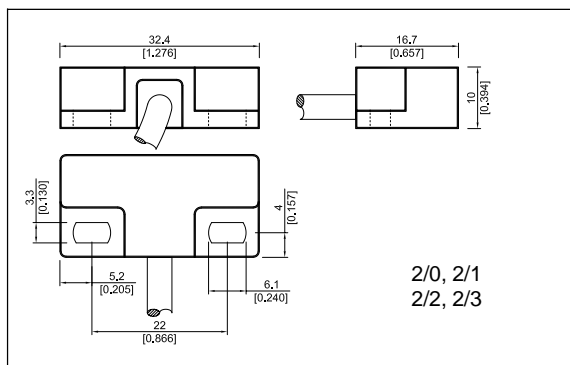

ORDER INFORMATION

Part Number Example

MK2/0 - 1A66 - 500 W

MK2/0 is the front operation series
1A is the contact form
66 is the switch model
500 is the cable length (mm)
W is the termination

	SERIES	CONTACT FORM	SWITCH MODEL	CABLE LENGTH(mm)	TERMINATION
	MKX/X -	XX	XX -	XXX	X
OPTIONS	2/0, 2/1 2/2*, 2/3*	1 Form A	66	500 **	S*, W, X, Y, U
		1 Form B	90		
	2/5	1 Form A	41		

* S option only available with 22/ and 2/3.
** Other cable length available.

www.meder.com

OPERATION EXAMPLE

For best operation it is recommended that you **DO NOT** mount these sensors on any ferromagnetic material **OR** use any ferromagnetic screws.

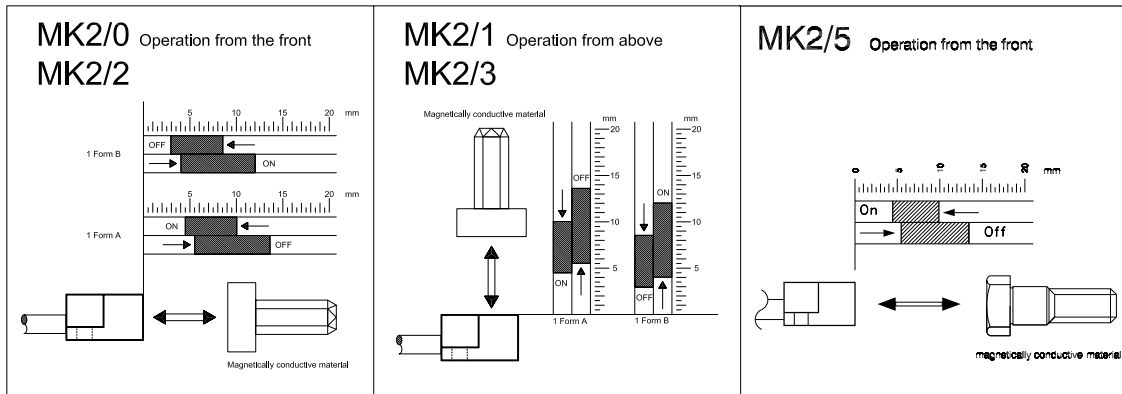

The MK2/2 and 2/3 are available as Form A and Form B sensors. The standard cable is a 4-wire round - core 4 x 0.14 mm² (cable sheath and wires are white) forming a sabotage loop. See example of this loop to the right.

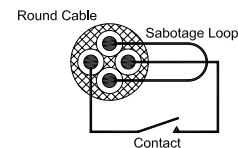

(Sabotage loop for MK2/2 and 2/3.)

TERMINATION

For wire and termination details please consult factory.

S		The cable cut length includes: 30 mm of exposed insulated wire with 5 mm of wire stripped and tinned
W		The cable cut length includes: 30 mm of exposed insulated wire with 5 mm of wire stripped and tinned
X		The cable cut length includes: 30 mm of exposed insulated wire with individual crimped terminals
Y		The cable cut length includes: 30 mm of exposed insulated wire with individual spade terminals
U		Cable with click sensor-connector (3 pole, M8)

Ferromagnetic Metal
Detection Sensors

CONTACT DATA

All data at 20 °C	Switch Model --> Contact Form -->	Switch 41 Form A			Switch 66 Form A			Switch 90 Form B			
Contact Ratings	Conditons	Min.	Typ.	Max.	Min.	Typ.	Max.	Min.	Typ.	Max.	Units
Switching Power	Any DC combination of V & A not to exceed their individual max			16			10			3	W
Switching Voltage	DC or peak AC			40			200			175	V
Switching Current	DC or peak AC			0.4			0.5			0.25	A
Carry Current	DC or peak AC			0.7			1.25			1.2	A
Static Contact Resistance	w/ 0.5 V & 50 mA			100			150			150	mΩ
Dynamic Contact Resistance	w/ 0.5 V & 50 mA			150			200			250	mΩ
Insulation Resistance (100 Volts applied)	Across contacts Contact to coil	10 ⁹			10 ^{10*}			10 ⁹			Ω
Breakdown Voltage	> 60 sec	150			225*			200			VDC
Operate Time, incl. Bounce	Measured w/ 100 % overdriv			0.7			0.5			0.7	ms
Reset Time	Measured w/ no coil suppression			0.05			0.1			1.5	ms
Capacitance	Across contacts Contact to coil		0.3			0.2			1.0		pF
Contact Operation**											
Must Operate Condition		8		12	4.5		10	3.0		8.5	mm
Must Release Condition		10		16	5.5		13.5	4.0		12	mm
Environmental Data											
Shock Resistance	1/2 sine wave duration 11ms			30			30			50	g
Vibration Resistance	From 10 - 2000 Hz			10			10			20	g
Amvient Temperature	10 °C/ minute max. allowable	-20		80	-20		85	-20		85	°C
Storage Temperature	10 °C/ minute max. allowable	-20		80	-35		85	-35		85	°C
Soldering Temperature	5 sec. dwell						260			260	°C

Please note: The indicated data are maximum values and can vary downwards when using a more sensitive switch.
 * Insulation resistance of 10¹² and breakdown voltage of 480 VDC is available.
 ** These ranges refer to the uncut / unmodified Reed Switches described in our Reed Switch section. Consult factory if more details is required.



Products for tomorrow...

Headquarter Europe
 MEDER electronic AG
 Friedrich-List Strasse 6
 D-78234 Engen-Welschingen
 Tel.: +49(0)7733-9487-0
 Fax: +49(0)7733-9487-32
 eMail: info@meder.com
 Internet: www.meder.com

Headquarter USA
 MEDER electronic Inc.
 766 Falmouth Rd
 Mashpee, MA 02649
 Phone: +1/ 508-539-0002
 Fax: +1/ 508-539-4088
 eMail: salesusa@meder.com

Reed Sensor: MK2/1-1A71-500W

Part Number: 2221711054

Dimensions (mm) / Marking

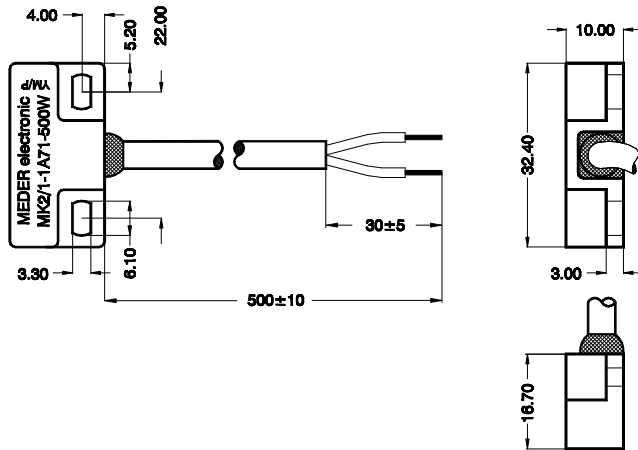

Switching distance

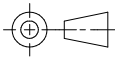
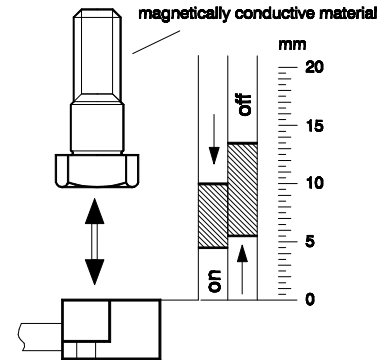

MEDER-Label

Type Production-Code EN60062/Factory Code

Switching Distance	Conditions at 20°C	Min.	Typ.	Max.	Units
Contact closed / Switch modified		4,5		10	mm
Contact opened / Switch modified		5,5		13,5	mm

Contact Data 71/7 (Form A/Dry)					
Contact Rating	Any combination of the switching voltage and current must not exceed the given rated power			10	W
Switching Voltage	DC or Peak AC			180	V
Switching Current	DC or Peak AC			0,5	A
Carry Current	DC or Peak AC			1,5	A
Static Contact Resistance (initial)	Measured with 40% overdrive			150	mΩ
Insulation Resistance	RH 45%	10 ¹²			Ω
Breakdown Voltage		200			VDC
Operate Time, including Bounce	Measured with 40% overdrive			0,5	ms
Release Time				0,1	ms
Capacitance			0,3		pF

Environmental Data					
Shock	½ sine wave, duration 11ms			150	g
Vibration	from 10 - 2000 Hz			10	g
Operating Temperature	10°C/min max. allowable	-20		85	°C
Storage Temperature	10°C/min max. allowable	-20		85	°C
Soldering Temperature	5 sec. at			260	°C
Cleaning				fully sealed	
Material of Case				Glassfibre reinforced polybutylene terephthalate (PBTP) self-extinguishing self-extinguishing V-0 according to UL94	
Sealing Compound				Polyurethane	
Cable				Round cable 2 x 0,25 mm ² , Ø3,4 mm, grey Colour of wire: brown / blue (brown / white) Ends of cable with approx. 5 mm tinned leads	
Contact Resistance with Cable	Measured with 40% overdrive			280	mΩ

Remarks	The MK2/1 must not be mounting on iron. When mounting the sensor, magnetically conductive screws must not be used.
---------	---