

Stud Diode

Rectifier Diode

SKN 70

SKR 70

Features

- Reverse voltages up to 1600 V
- Hermetic metal case with glass insulator
- Threaded stud ISO M8
- SKN: anode to stud, SKR: cathode to stud

Typical Applications*

- All-purpose mean power rectifier diodes
- Cooling via heatsinks
- Non-controllable and half-controllable rectifiers
- Free-wheeling diodes
- Recommended snubber network:
RC: 0,1 μ F, 100 Ω ($P_R = 2$ W)
 $R_P = 80$ k Ω ($P_R = 6$ W)

V_{RSM} V	V_{RRM} V	$I_{FRMS} = 150$ A (maximum value for continuous operation) $I_{FAV} = 70$ A (sin. 180; $T_c = 125$ °C)	
400	400	SKN 70/04	SKR 70/04
800	800	SKN 70/08	SKR 70/08
1200	1200	SKN 70/12	SKR 70/12
1400	1400	SKN 70/14	SKR 70/14
1600	1600	SKN 70/16	SKR 70/16

Symbol	Conditions	Values	Units
I_{FAV}	sin. 180; $T_c = 100$ °C	95	A
I_D	K 1,1; $T_a = 45$ °C; B2 / B6	112 / 159	A
	K 1,1F; $T_a = 35$ °C; B2 / B6	174 / 246	A
I_{FSM}	$T_{vj} = 25$ °C; 10 ms	1150	A
	$T_{vj} = 180$ °C; 10 ms	1000	A
i^2t	$T_{vj} = 25$ °C; 8,3 ... 10 ms	6600	A ² s
	$T_{vj} = 180$ °C; 8,3 ... 10 ms	5000	A ² s
V_F	$T_{vj} = 25$ °C; $I_F = 200$ A	max. 1,5	V
$V_{(TO)}$	$T_{vj} = 180$ °C	max. 0,85	V
r_T	$T_{vj} = 180$ °C	max. 3	m Ω
I_{RD}	$T_{vj} = 180$ °C; $V_{RD} = V_{RRM}$	max. 10	mA
Q_{rr}	$T_{vj} = 160$ °C; $-di_F/dt = 10$ A/ μ s	70	μ C
$R_{th(j-c)}$		0,55	K/W
$R_{th(c-s)}$		0,2	K/W
T_{vj}		- 40 ... + 180	°C
T_{stg}		- 55 ... + 180	°C
V_{isol}		-	V~
M_s	to heatsink	4	Nm
a		5 * 9,81	m/s ²
m	approx.	30	g
Case		E 12	

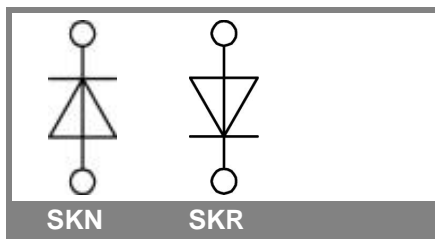

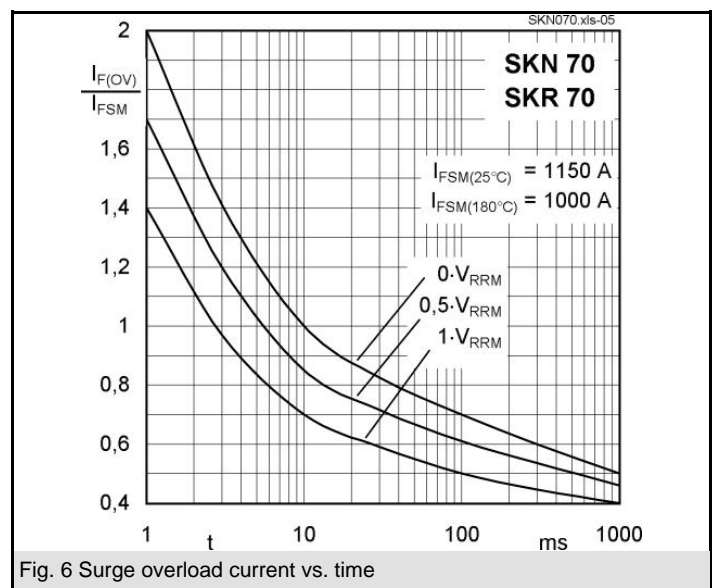
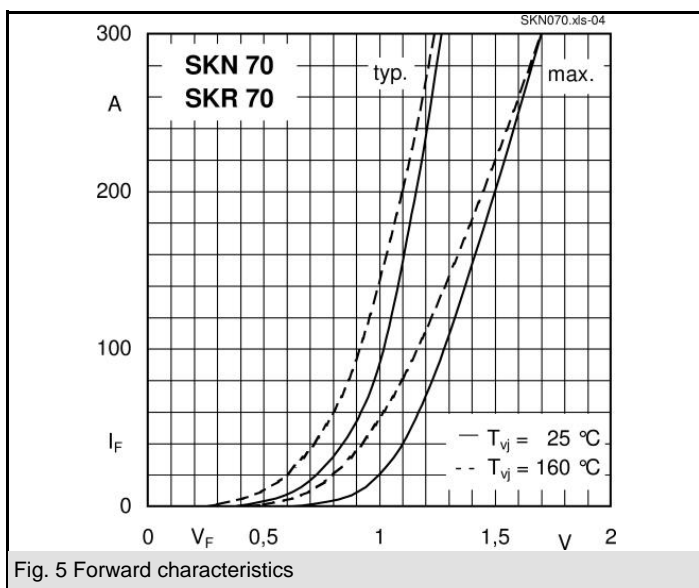
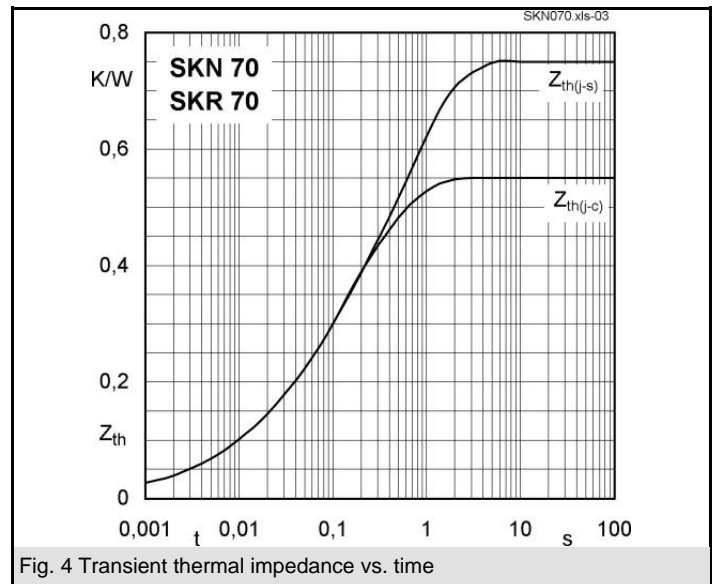
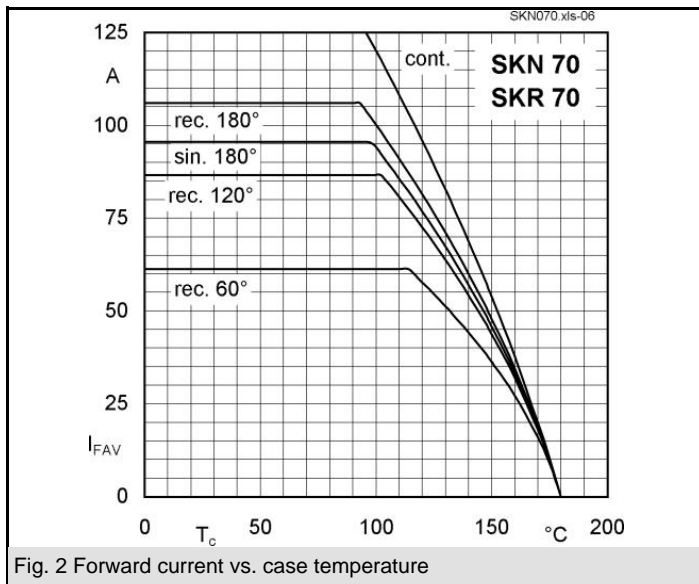
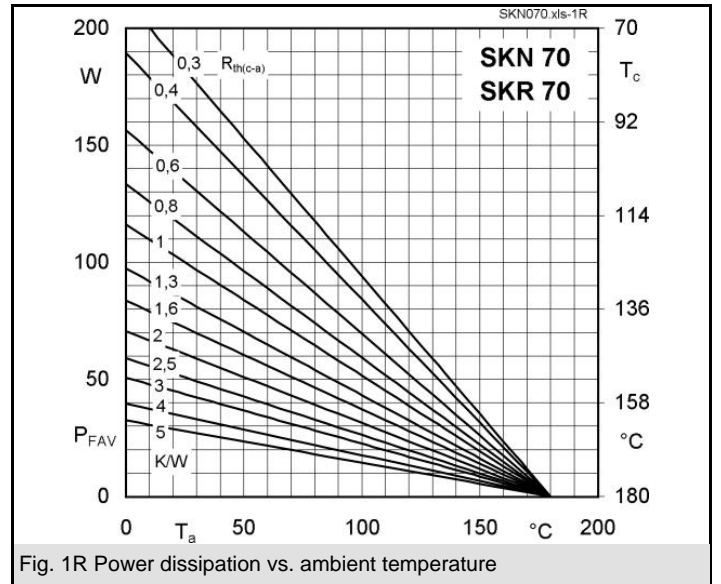
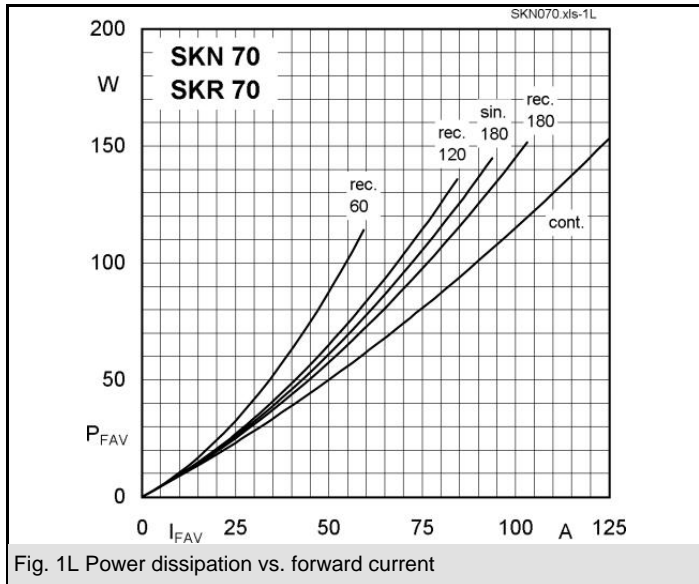

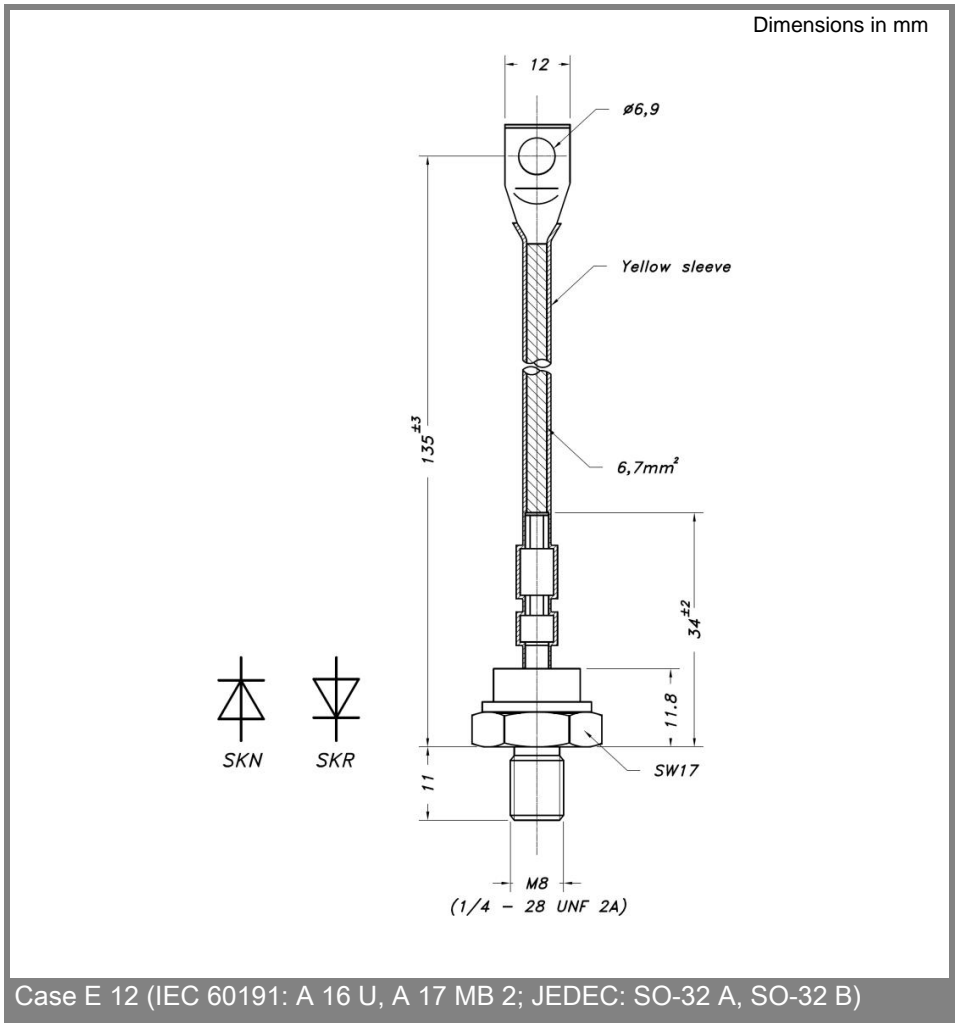

* The specifications of our components may not be considered as an assurance of component characteristics. Components have to be tested for the respective application. Adjustments may be necessary. The use of SEMIKRON products in life support appliances and systems is subject to prior specification and written approval by SEMIKRON. We therefore strongly recommend prior consultation of our personal.