



## PolySwitch Resettable Devices Surface-mount Devices

Originally introduced more than 15 years ago, PolySwitch surface-mount devices are now the preferred circuit protection method for computer, consumer, multimedia, portable, and automotive electronics applications.

In an effort to reduce the size and cost of surface mount devices, we introduced the miniSMD product series in 1995. Subsequently, we developed the microSMD, nanoSMD and picoSMD family of products. The picoSMD series reduced the device size to a 2012mm (0805 mils) foot print, one fourth the size of the popular miniSMD series.

Recent additions to the PolySwitch surface-mount series include 24V miniSMD 4532mm (1812 mils), 60V decaSMD 5050mm (2018 mils), and 2.0A microSMD 3225mm (1210 mils) devices.



### Benefits

- Smaller size saves board space and cost
- Many product choices give engineers more design flexibility
- Compatible with high-volume electronics assembly
- Assists in meeting regulatory requirements
- Higher voltage ratings allow use in new applications

### Features

- RoHS compliant
- Broadest range of resettable devices available in the industry
- Current ratings from 0.05 to 3A
- Voltage ratings from 6V computer and electronic applications to 60V telecom applications
- Agency recognition: UL, CSA, TÜV
- Small footprint
- Fast time-to-trip
- Low resistance

### Applications

- |                        |                           |                       |
|------------------------|---------------------------|-----------------------|
| • Computer             | • Game machines           | • Automotive          |
| • Portable electronics | • Telephony and broadband | • Industrial controls |
| • Multimedia           | • Mobile phones           | • Battery             |

## Protection Application Selection Table for Surface-mount Devices

- The table below lists PolySwitch devices and SiBar devices typically used in these applications.
- Specifications for the suggested device part numbers can be found in this section.
- Once a part has been selected, the user should evaluate and test each product for the intended application.

Protection Application	Additional Comments	Overcurrent Overvoltage	PolySwitch Resettable Devices - Key Selection Criteria		
			Small Size	Low Resistance	Fast Time-to-trip (Temperature Protection)
AC adapter input power	use w/ Zener & triac		SMD250F	SMD250F	SMD200F
Battery pack protection			nanoSMDC150F	miniSMDC260F	miniSMDE190F
Charger protection			nanoSMDC050F	miniSMDC110F/16	nanoSMDC075F
CPU/IC protection			nanoSMDC110F	nanoSMDC150F	nanoSMDC075F
Data acquisition/sensor			microSMD005F	-	microSMD005F
DC input/output power	≤6V		nanoSMDC075F	nanoSMDC150F	nanoSMDC050F/13.2
	≤12V		miniSMDC075F	miniSMDC110F/16	miniSMDC075F
DDC			nanoSMDC075F	nanoSMDC110F	nanoSMDC050F/13.2
Device Bay system	DB12, DB20		miniSMDC200F	miniSMDC260F	miniSMDC200F
	DB32		miniSMDC260F	SMD300F	miniSMDC200F
Ethernet/Lan			nanoSMDC050F/13.2	miniSMDC110F/16	nanoSMDC075F
Fan			microSMD035F	microSMD050F	microSMD035F
HDMI			picoSMD035F	picoSMD035F	picoSMD035F
IEEE 802.3af	VOIP		decaSMDC050F/60	decaSMDC050F/60	decaSMDC050F/60
IEEE-1394	power provider		SMD100F/33	SMD185F	SMD100F/33
	alt. power provider		SMD185F	SMD185F	SMD150F/33
	self-powered		SMD185F	SMD185F	SMD150F/33
LCD inverter			nanoSMDC050F/13.2	miniSMDC110F/16	nanoSMDC075F
LCD screen power			nanoSMDC050F/13.2	nanoSMDC050F/13.2	microSMD035F
LNB (Low Noise Block)			SMD075F	SMD075F	SMD050F
Motor	≤6V		nanoSMDC110F	nanoSMDC150F	microSMD075F
	≤13.2V		miniSMDC075F	miniSMDC110F/16	miniSMDC075F
PS/2 mouse/keyboard			nanoSMDC075F	nanoSMDC110F	nanoSMDC050F/13.2
Signal - data communication	≤6V		nanoSMDC075F	nanoSMDC075F	nanoSMDC075F
	≤13.2V		miniSMDC050F	miniSMDC075F	miniSMDC020F
	≤30V		SMD030F-2018	SMD075F	SMD050F
SCSI			nanoSMDC110F	nanoSMDC150F	nanoSMDC075F
Smart card reader			microSMD010F	microSMD035F	microSMD005F
Telecom - modem	Digital line	OC	miniSMDC014F	miniSMDC014F	miniSMDC014F
		OV	TVBxxx(N/M/R)SC-L*	TVBxxx(N/M/R)SC-L*	TVBxxx(N/M/R)SC-L*
Telecom - PBX	Subscriber	OC	miniSMDC014F	miniSMDC014F	miniSMDC014F
Temperature sensor	CPU		nanoSMDC050F/13.2	nanoSMDC075F	nanoSMDC050F/13.2
USB	Individual Port		nanoSMDC075F	nanoSMDC110F	nanoSMDC050F/13.2
	2 port ganged		nanoSMDC150F	miniSMDC150F	miniSMDC125F
	3 port ganged		miniSMDC200F	miniSMDC200F	miniSMDC200F

**Note:** This list is not exhaustive. Tyco Electronics welcomes our customers' input for additional application ideas for PolySwitch resettable devices.

\*Refer to the SiBar product section on page 37 for more information.

**Table S1 Product Series: Size, Current Rating, Voltage Rating/Maximum Resistance for Surface-mount Devices**

	picoSMD	nanoSMD	microSMD	miniSMD	midSMD	SMD	SMD2	miniSMDE	decaSMD
<b>Size mm (mils)</b>	2012 (0805)	3216 (1206)	3225 (1210)	4532 (1812)	5050 (2018)	7555 (2920)	8763 (3425)	11550 (4420)	5050 (2018)
<b>Hold Current (A)</b>	-	-	-	-	-	-	-	-	-
0.050	-	-	30V <sub>DC</sub> /50Ω	-	-	-	-	-	-
0.100	-	-	30V <sub>DC</sub> /15Ω	-	-	-	-	-	-
0.120	-	48V <sub>DC</sub> /6.50Ω	-	-	-	-	-	-	-
0.140	-	-	-	60V <sub>DC</sub> /6.00Ω	-	-	-	-	-
0.160	-	48V <sub>DC</sub> /5.00Ω	-	-	-	-	-	-	-
0.200	-	24V <sub>DC</sub> /3.30Ω	-	30V <sub>DC</sub> /3.30Ω	-	-	-	-	-
0.300	-	-	-	-	60V <sub>DC</sub> /2.30Ω	60V <sub>DC</sub> /4.80Ω	-	-	-
0.350	6V <sub>DC</sub> /1.40Ω	16V <sub>DC</sub> /1.50Ω	6V <sub>DC</sub> /1.30Ω	-	-	-	-	-	-
0.500	-	13.2V <sub>DC</sub> /0.80Ω	13.2V <sub>DC</sub> /0.90Ω	24V <sub>DC</sub> /1.00Ω	-	60V <sub>DC</sub> /1.40Ω	-	-	60V <sub>DC</sub> /1.10Ω
0.750	-	6V <sub>DC</sub> /0.40Ω	6V <sub>DC</sub> /0.40Ω	13.2V <sub>DC</sub> /0.45Ω	-	30V <sub>DC</sub> /1.00Ω	-	-	-
	-	-	-	24V <sub>DC</sub> /0.29Ω	-	60V <sub>DC</sub> /1.00Ω	-	-	-
1.000	-	6V <sub>DC</sub> /1.50Ω	-	-	15V <sub>DC</sub> /0.40Ω	30V <sub>DC</sub> /0.48Ω	-	-	-
	-	-	-	-	-	33V <sub>DC</sub> /0.41Ω	-	-	-
1.100	-	6V <sub>DC</sub> /0.20Ω	6V <sub>DC</sub> /0.21Ω	8V <sub>DC</sub> /0.21Ω	-	-	-	-	-
	-	-	-	16V <sub>DC</sub> /0.18Ω	-	-	-	-	-
	-	-	-	24V <sub>DC</sub> /0.18Ω	-	-	-	-	-
1.200	-	-	-	-	-	16V <sub>DC</sub> /0.34Ω	-	-	-
1.250	-	-	-	6V <sub>DC</sub> /0.14Ω	-	15V <sub>DC</sub> /0.25Ω	-	-	-
	-	-	-	16V <sub>DC</sub> /0.14Ω	-	-	-	-	-
1.500	-	6V <sub>DC</sub> /0.11Ω	6V <sub>DC</sub> /0.11Ω	6V <sub>DC</sub> /0.11Ω	15V <sub>DC</sub> /0.18Ω	-	15V <sub>DC</sub> /0.25Ω	-	-
	-	-	-	12V <sub>DC</sub> /0.11Ω	-	-	33V <sub>DC</sub> /0.23Ω	-	-
	-	-	-	24V <sub>DC</sub> /0.12Ω	-	-	-	-	-
1.600	-	-	-	9V <sub>DC</sub> /0.10Ω	-	-	16V <sub>DC</sub> /0.15Ω	-	-
1.750	-	-	6V <sub>DC</sub> /0.08Ω	-	-	-	-	-	-
1.850	-	-	-	-	-	-	33V <sub>DC</sub> /0.165Ω	-	-
1.900	-	-	-	-	-	-	-	16V <sub>DC</sub> /0.08Ω	-
2.000	-	6V <sub>DC</sub> /0.07Ω*	6V <sub>DC</sub> /0.06Ω	8V <sub>DC</sub> /0.07Ω	6V <sub>DC</sub> /0.10Ω	-	15V <sub>DC</sub> /0.125Ω	-	-
2.500	-	-	-	-	-	-	15V <sub>DC</sub> /0.85Ω	-	-
2.600	-	-	-	6V <sub>DC</sub> /0.043Ω	-	6V <sub>DC</sub> /0.075Ω	-	-	-
	-	-	-	12V <sub>DC</sub> /0.047Ω	-	-	-	-	-
	-	-	-	13.2V <sub>DC</sub> /0.50Ω	-	-	-	-	-
	-	-	-	16V <sub>DC</sub> /0.05Ω	-	-	-	-	-
3.000	-	-	-	-	-	6V <sub>DC</sub> /0.048Ω	-	-	-

**Table S2 Thermal Derating for Surface-mount Devices [Hold Current (A) at Ambient Temperature (°C)]**

Part Number	Maximum Ambient Temperature											
	-40°C	-20°C	0°C	20°C	25°C	40°C	50°C	60°C	70°C	80°C	85°C	125°C
<b>picoSMD Series</b>												
Size 2012 mm/0805 mils												
<b>NEW</b> picoSMD035F	0.58	0.51	0.44	0.35	0.32	0.31	0.28	0.24	0.21	0.18	0.16	-
<b>nanoSMDC Series</b>												
Size 3216 mm/1206 mils												
nanoSMDC012F	0.20	0.17	0.15	0.13	0.12	0.11	0.10	0.09	0.08	0.07	0.07	-
nanoSMDC016F	0.21	0.20	0.18	0.16	0.16	0.14	0.13	0.12	0.11	0.10	0.09	-
nanoSMDC020F	0.34	0.30	0.26	0.22	0.20	0.17	0.15	0.13	0.11	0.09	0.08	-
nanoSMDC035F	0.58	0.51	0.44	0.38	0.35	0.31	0.28	0.24	0.21	0.18	0.16	-
nanoSMDC050F/13.2	0.78	0.69	0.61	0.52	0.50	0.44	0.39	0.35	0.30	0.25	0.24	-
nanoSMDC075F	1.15	1.04	0.92	0.78	0.75	0.69	0.63	0.58	0.51	0.46	0.43	-
nanoSMDC110F	1.64	1.46	1.30	1.10	1.06	0.92	0.83	0.80	0.65	0.56	0.52	-
nanoSMDC150F	2.20	1.99	1.77	1.55	1.50	1.34	1.23	1.10	1.01	0.90	0.84	-
<b>coming soon</b> nanoSMDC200F*	3.56	3.08	2.60	2.12	2.00	1.79	1.64	1.50	1.36	1.21	1.14	-

\* Data is preliminary

**Table S2 Thermal Derating for Surface-mount Devices  
[Hold Current (A) at Ambient Temperature (°C)]**

... Cont'd

Part Number	Maximum Ambient Temperature											
	-40°C	-20°C	0°C	20°C	25°C	40°C	50°C	60°C	70°C	80°C	85°C	125°C
<b>microSMD Series</b>												
<b>Size 3225 mm/1210 mils</b>												
microSMD005F	0.08	0.07	0.06	0.05	0.05	0.04	0.04	0.03	0.03	0.02	0.02	-
microSMD010F	0.15	0.13	0.12	0.10	0.10	0.09	0.08	0.06	0.06	0.05	0.05	-
microSMD035F	0.51	0.46	0.40	0.35	0.34	0.30	0.27	0.24	0.22	0.19	0.18	-
microSMD050F	0.76	0.66	0.58	0.50	0.48	0.42	0.38	0.35	0.29	0.25	0.23	-
microSMD075F	1.10	0.97	0.86	0.75	0.72	0.64	0.58	0.55	0.47	0.42	0.39	-
microSMD110F	1.60	1.42	1.26	1.10	1.06	0.94	0.86	0.80	0.70	0.62	0.58	-
microSMD150F	2.30	2.02	1.76	1.50	1.43	1.24	1.11	1.00	0.85	0.72	0.65	-
microSMD175F	2.80	2.45	2.10	1.75	1.70	1.55	1.45	1.35	1.25	1.15	1.10	-
<b>NEW</b> microSMD200F	2.60	2.44	2.35	2.00	1.96	1.78	1.67	1.50	1.45	1.15	1.10	-
<b>miniSMDC Series</b>												
<b>Size 4532 mm/1812 mils</b>												
miniSMDC014F	0.23	0.20	0.17	0.14	0.13	0.11	0.10	0.09	0.07	0.06	0.05	-
miniSMDC020F	0.30	0.27	0.23	0.20	0.19	0.17	0.15	0.13	0.12	0.10	0.09	-
miniSMDC050F	0.59	0.57	0.55	0.50	0.48	0.45	0.43	0.35	0.30	0.25	0.23	-
miniSMDC075F	1.10	0.99	0.87	0.75	0.72	0.63	0.57	0.49	0.45	0.39	0.35	-
miniSMDC075F/24	1.50	1.25	1.00	0.75	0.73	0.65	0.60	0.55	0.50	0.45	0.43	-
miniSMDC110F	1.60	1.45	1.28	1.10	1.07	0.92	0.83	0.71	0.66	0.57	0.52	-
miniSMDC110F/16	1.68	1.49	1.30	1.10	1.05	0.92	0.83	0.75	0.64	0.55	0.50	-
miniSMDC110F/24	2.00	1.70	1.40	1.10	1.06	0.95	0.88	0.80	0.73	0.65	0.61	-
miniSMDC125F	2.00	1.69	1.47	1.25	1.17	1.03	0.92	0.90	0.69	0.58	0.53	-
miniSMDC125F/16	2.00	1.69	1.47	1.25	1.17	1.03	0.92	0.90	0.69	0.58	0.53	-
miniSMDC150F	2.30	2.05	1.77	1.50	1.44	1.23	1.09	0.95	0.82	0.68	0.61	-
miniSMDC150F/12	2.40	2.10	1.80	1.50	1.44	1.25	1.13	1.00	0.88	0.75	0.69	-
miniSMDC150F/24	2.10	1.90	1.70	1.50	1.44	1.25	1.13	1.00	0.88	0.75	0.69	-
miniSMDC160F	2.50	2.19	1.89	1.60	1.53	1.31	1.16	1.10	0.95	0.79	0.71	-
miniSMDC200F	2.60	2.44	2.22	2.00	1.96	1.78	1.67	1.50	1.45	1.34	1.29	-
miniSMDC260F	3.40	3.16	2.80	2.60	2.54	2.32	2.18	2.00	1.90	1.76	1.69	-
miniSMDC260F/12	3.40	3.16	3.00	2.60	2.54	2.32	2.18	2.00	1.90	1.76	1.69	-
miniSMDC260F/13.2	3.40	3.16	3.00	2.60	2.54	2.32	2.18	2.00	1.90	1.76	1.69	-
<b>NEW</b> miniSMDC260F/16	3.50	3.20	3.00	2.60	2.53	2.30	2.15	2.00	1.85	1.70	1.63	-
<b>miniSMDE Series</b>												
<b>Size 11550 mm/4420 mils</b>												
miniSMDE190F	3.16	2.74	2.20	1.90	1.74	1.48	1.27	1.10	0.80	0.50	0.35	-
<b>midSMD Series</b>												
<b>Size 5050 mm/2018 mils</b>												
SMD030F-2018	0.48	0.42	0.35	0.30	0.28	0.24	0.21	0.17	0.15	0.12	0.10	-
decaSMDC050F/60	1.00	0.85	0.70	0.55	0.53	0.45	0.40	0.35	0.30	0.25	0.23	-
SMD100F-2018	1.59	1.43	1.20	1.10	1.03	0.94	0.85	0.72	0.69	0.61	0.57	-
SMD150F-2018	2.21	1.97	1.70	1.50	1.43	1.26	1.15	1.00	0.91	0.79	0.73	-
SMD200F-2018	2.81	2.54	2.27	2.00	1.93	1.73	1.59	1.46	1.32	1.19	1.12	-
<b>SMD Series</b>												
<b>Size 7555 mm/2920 mils</b>												
SMD030F	0.44	0.39	0.32	0.30	0.28	0.26	0.23	0.19	0.18	0.17	0.15	-
SMD050F	0.73	0.65	0.55	0.50	0.47	0.43	0.39	0.33	0.31	0.28	0.26	-
SMD075F	1.11	0.99	0.84	0.75	0.71	0.63	0.57	0.49	0.45	0.39	0.36	-
SMD075F/60	1.11	0.99	0.84	0.75	0.71	0.63	0.57	0.49	0.45	0.39	0.36	-
SMD100F	1.59	1.43	1.20	1.10	1.03	0.94	0.85	0.72	0.69	0.61	0.57	-
SMD100F/33	1.48	1.35	1.20	1.10	1.06	0.98	0.91	0.83	0.79	0.73	0.69	-
SMDH120	2.34	1.96	1.58	1.20	1.15	1.02	0.92	0.83	0.74	0.65	0.60	0.26
SMD125F	1.89	1.68	1.50	1.25	1.21	1.04	0.93	0.85	0.71	0.61	0.55	-
SMD260F	3.82	3.41	2.90	2.60	2.45	2.19	1.99	1.70	1.58	1.38	1.28	-
SMD300F	4.13	3.75	3.30	3.00	2.87	2.62	2.43	2.25	2.00	1.87	1.78	-
<b>SMD2 Series</b>												
<b>Size 8763 mm/3425 mils</b>												
SMD150F	2.30	2.04	1.80	1.50	1.45	1.23	1.10	0.99	0.83	0.70	0.63	-
SMD150F/33	2.30	2.04	1.80	1.50	1.45	1.23	1.10	0.99	0.83	0.70	0.63	-
SMDH160	2.14	1.96	1.78	1.60	1.56	1.42	1.33	1.24	1.15	1.06	1.02	0.44
SMD185F	2.54	2.29	2.20	1.85	1.80	1.55	1.43	1.31	1.19	1.06	1.00	-
SMD200F	3.01	2.67	2.30	2.00	1.90	1.66	1.50	1.30	1.16	0.99	0.91	-
SMD250F	3.72	3.31	2.80	2.50	2.35	2.09	1.89	1.60	1.48	1.28	1.18	-

14

**Figure S1 Thermal Derating Curve for Surface-mount Devices**

- A =** picoSMD / nanoSMD / microSMD / miniSMD / decaSMD and SMD
- B =** miniSMDE190F
- C =** SMDH120 and SMDH160

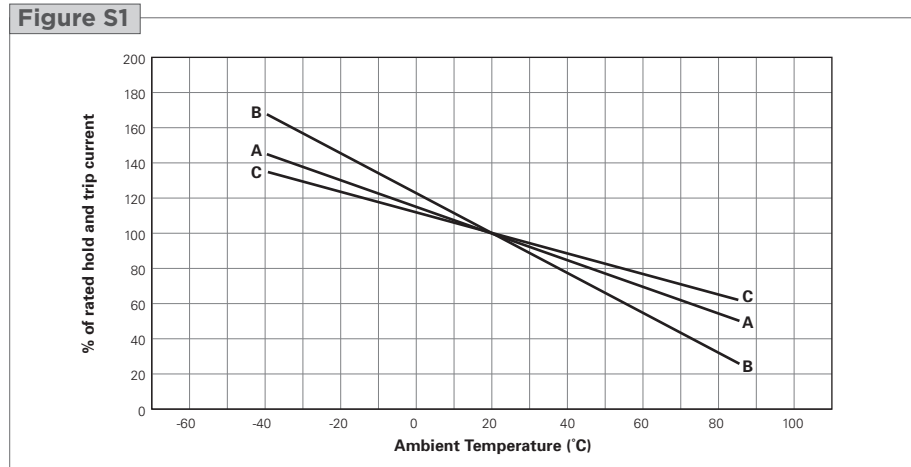

**Table S3 Electrical Characteristics for Surface-mount Devices at Room Temperature**

Part Number	I <sub>H</sub> (A)	I <sub>T</sub> (A)	V <sub>Max</sub> (V <sub>DC</sub> )	I <sub>Max</sub> (A)	P <sub>D Max</sub> (W)	Max. Time-to-Trip (A) (S)		R <sub>Min</sub> (Ω)	R <sub>1 Max</sub> (Ω)	Figure for Dimensions
<b>picoSMD Series</b> Size 2012 mm/0805 mils										
<b>NEW</b> picoSMD035F	0.35	0.75	6	20	0.60	3.50	0.10	0.42	1.40	S6
<b>nanoSMDC Series</b> Size 3216 mm/1206 mils										
nanoSMDC012F	0.12	0.39	48	10	0.50	1.00	0.20	1.40	6.50	S2
nanoSMDC016F	0.16	0.45	48	10	0.50	1.00	0.30	1.10	5.00	S2
nanoSMDC020F	0.20	0.42	24	100	0.60	8.00	0.10	0.65	3.30	S2
nanoSMDC035F	0.35	0.75	16	20	0.60	3.50	0.10	0.45	1.40	S2
nanoSMDC050F/13.2	0.50	1.10	13.2	100	0.80	8.00	0.10	0.20	0.80	S2
nanoSMDC075F	0.75	1.50	6	100	0.80	8.00	0.10	0.12	0.40	S2
nanoSMDC110F	1.10	2.20	6	100	0.80	8.00	0.10	0.07	0.20	S2
nanoSMDC150F	1.50	3.00	6	100	0.80	8.00	0.30	0.04	0.11	S2
<b>coming soon</b> nanoSMDC200F*	2.00	4.00	6	100	1.00	8.00	TBD	0.02	0.07	S2
<b>microSMD Series</b> Size 3225 mm/1210 mils										
microSMD005F	0.05	0.15	30	10	1.00	0.25	1.50	3.60	50.00	S3
microSMD010F	0.10	0.25	30	10	0.80	0.50	1.00	2.10	15.00	S2
microSMD035F	0.35	0.75	6	40	0.80	8.00	0.20	0.32	1.30	S2
microSMD050F	0.50	1.00	13.2	40	0.80	8.00	0.05	0.25	0.90	S2
microSMD075F	0.75	1.50	6	40	0.80	8.00	0.10	0.11	0.40	S2
microSMD110F	1.10	2.20	6	40	0.80	8.00	0.20	0.07	0.21	S2
microSMD150F	1.50	3.00	6	40	0.80	8.00	1.00	0.04	0.11	S2
microSMD175F	1.75	3.50	6	40	0.80	8.00	0.80	0.025	0.08	S2
<b>NEW</b> microSMD200F	2.00	4.00	6	100	0.80	8.00	2.50	0.020	0.06	S2
<b>miniSMDC Series</b> Size 4532 mm/1812 mils										
miniSMDC014F	0.14	0.28	60	10	0.75	8.00	0.008	1.50	6.00	S2
miniSMDC020F	0.20	0.40	30	10	0.80	8.00	0.02	0.60	3.30	S2
miniSMDC050F	0.50	1.00	24	100	0.80	8.00	0.15	0.15	1.00	S2
miniSMDC075F	0.75	1.50	13.2	100	1.00	8.00	0.20	0.11	0.45	S2
miniSMDC075F/24	0.75	1.50	24	40	0.80	8.00	0.30	0.09	0.29	S2
miniSMDC110F	1.10	2.20	8	100	1.20	8.00	0.30	0.04	0.21	S2
miniSMDC110F/16	1.10	2.20	16	100	0.80	8.00	0.30	0.06	0.18	S2
miniSMDC110F/24	1.10	2.20	24	20	0.80	8.00	0.50	0.06	0.18	S2
miniSMDC125F	1.25	2.50	6	100	0.80	8.00	0.40	0.05	0.14	S2
miniSMDC125F/16	1.25	2.50	16	100	0.80	8.00	0.40	0.05	0.14	S2
miniSMDC150F	1.50	3.00	6	100	0.80	8.00	0.50	0.04	0.11	S2
miniSMDC150F/12	1.50	2.80	12	100	0.80	8.00	0.50	0.04	0.11	S2
miniSMDC150F/24	1.50	3.00	24	20	1.00	8.00	1.50	0.04	0.12	S2
miniSMDC160F	1.60	3.20	9	100	0.80	8.00	1.00	0.03	0.10	S2
miniSMDC200F	2.00	4.00	8	100	1.00	8.00	5.00	0.02	0.07	S2
miniSMDC260F	2.60	5.00	6	100	1.00	8.00	7.00	0.015	0.043	S2

\* Data is preliminary

**Table S3 Electrical Characteristics for Surface-mount Devices at Room Temperature** ... Cont'd

Part Number	$I_H$ (A)	$I_T$ (A)	$V_{Max}$ ( $V_{DC}$ )	$I_{Max}$ (A)	$P_{D Max}$ (W)	Max. Time-to-Trip (A) (S)		$R_{Min}$ ( $\Omega$ )	$R_{1 Max}$ ( $\Omega$ )	Figure for Dimensions
<b>miniSMDC Series</b> Size 4532 mm/1812 mils										
miniSMDC260F/12	2.60	5.00	12	100	1.00	8.00	5.00	0.015	0.047	S2
miniSMDC260F/13.2	2.60	5.00	13.2	100	1.20	8.00	5.00	0.015	0.050	S2
<b>NEW</b> miniSMDC260F/16	2.60	5.00	16	100	1.20	8.00	5.00	0.015	0.050	S2
<b>miniSMDE Series</b> Size 11550 mm/4420 mils										
miniSMDE190F	1.90	3.80	16	100	1.50	10.00	2.00	0.024	0.08	S2
<b>midSMD Series</b> Size 5050 mm/2018 mils										
SMD030F-2018	0.30	0.80	60	20	0.90	1.50	1.50	0.50	2.30	S4
decaSMD050F/60	0.55	1.10	60	10	1.00	8.00	0.10	0.40	1.10	S2
SMD100F-2018	1.10	2.20	15	40	1.40	8.00	0.50	0.10	0.40	S4
SMD150F-2018	1.50	3.00	15	40	1.80	8.00	1.00	0.07	0.18	S4
SMD200F-2018	2.00	4.20	6	40	1.50	8.00	3.00	0.048	0.10	S4
<b>SMD Series</b> Size 7555 mm/2920 mils										
SMD030F	0.30	0.60	60	10	1.70	1.50	3.00	1.20	4.80	S5
SMD050F	0.50	1.00	60	10	1.70	2.50	4.00	0.35	1.40	S5
SMD075F	0.75	1.50	30	40	1.70	8.00	0.30	0.35	1.00	S5
SMD075F/60	0.75	1.50	60	10	1.70	8.00	0.30	0.35	1.00	S5
SMD100F	1.10	2.20	30	40	1.70	8.00	0.50	0.12	0.48	S5
SMD100F/33	1.10	2.20	33	40	1.70	8.00	0.50	0.12	0.41	S5
SMDH120	1.20	2.30	16	50	2.00	8.00	2.00	0.15	0.34	S5
SMD125F	1.25	2.50	15	40	1.70	8.00	2.00	0.07	0.25	S5
SMD260F	2.60	5.20	6	40	1.70	8.00	20.00	0.025	0.075	S5
SMD300F	3.00	6.00	6	40	1.50	8.00	35.00	0.015	0.048	S5
<b>SMD2 Devices</b> Size 8763 mm/3425 mils										
SMD150F	1.50	3.00	15	40	1.90	8.00	5.00	0.06	0.25	S5
SMD150F/33	1.50	3.00	33	40	1.90	8.00	5.00	0.08	0.23	S5
SMDH160	1.60	3.20	16	70	2.20	8.00	15.00	0.05	0.15	S5
SMD185F	1.85	3.60	33	40	1.50	8.00	5.00	0.065	0.165	S5
SMD200F	2.00	4.00	15	40	1.90	8.00	12.00	0.05	0.125	S5
SMD250F	2.50	5.00	15	40	1.90	8.00	25.00	0.035	0.085	S5

**Figure S2-S6 Dimension Figures for Surface-mount Devices**

**Figure S2**

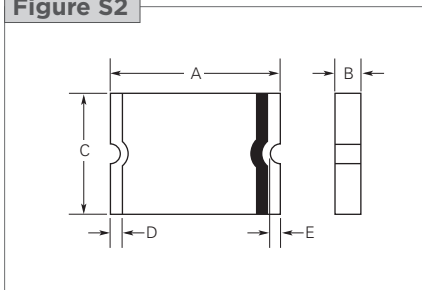

**Figure S3**

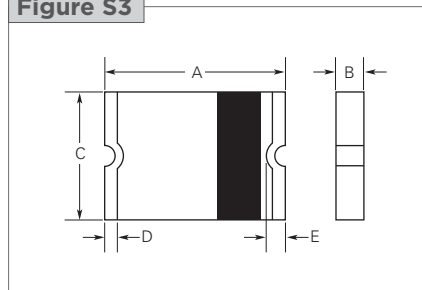

**Figure S4**

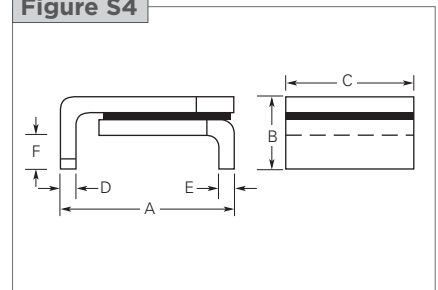

**Figure S5**

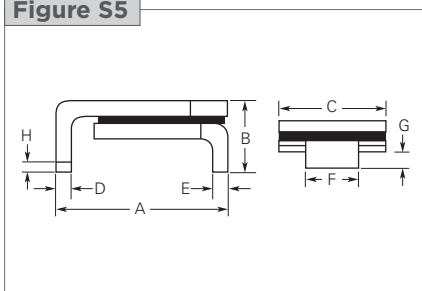

**Figure S6**

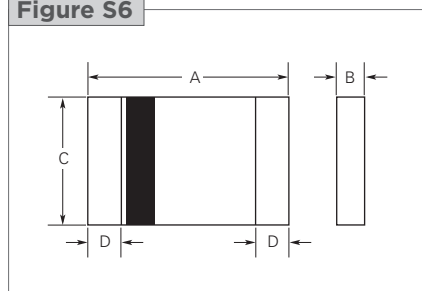

14

**Table S4 Dimensions for Surface-mount Devices in Millimeters (Inches)**

Part Number	A		B		C		D		E		F		G		H	Figure
	min	max	min	max	min	max	min	max	min	max	min	max	min	max	min	
<b>■ picoSMD Series</b>																
<b>Size 2012 mm/0805 mils</b>																
<b>NEW</b> picoSMD035F	1.80 (0.071)	2.21 (0.087)	0.38 (0.015)	0.81 (0.032)	1.17 (0.046)	1.45 (0.057)	0.15 (0.006)	0.60 (0.024)	-	-	-	-	-	-	-	S6
<b>■ nanoSMDC Series</b>																
<b>Size 3216 mm/1206 mils</b>																
nanoSMDC012F	3.00 (0.118)	3.40 (0.134)	0.62 (0.024)	1.00 (0.039)	1.37 (0.054)	1.80 (0.071)	0.25 (0.010)	0.75 (0.030)	0.076 (0.003)	-	-	-	-	-	-	S2
nanoSMDC016F	3.00 (0.118)	3.40 (0.134)	0.62 (0.024)	1.00 (0.039)	1.37 (0.054)	1.80 (0.071)	0.25 (0.010)	0.75 (0.030)	0.076 (0.003)	-	-	-	-	-	-	S2
nanoSMDC020F	3.00 (0.118)	3.40 (0.134)	0.38 (0.015)	0.64 (0.025)	1.37 (0.054)	1.80 (0.071)	0.25 (0.010)	0.75 (0.030)	0.076 (0.003)	-	-	-	-	-	-	S2
nanoSMDC035F	3.00 (0.118)	3.40 (0.134)	0.38 (0.015)	0.64 (0.025)	1.37 (0.054)	1.80 (0.071)	0.25 (0.010)	0.75 (0.030)	0.076 (0.003)	-	-	-	-	-	-	S2
nanoSMDC050F/13.2	3.00 (0.118)	3.40 (0.134)	0.38 (0.015)	0.64 (0.025)	1.37 (0.054)	1.80 (0.071)	0.25 (0.010)	0.75 (0.030)	0.076 (0.003)	-	-	-	-	-	-	S2
nanoSMDC075F	3.00 (0.118)	3.40 (0.134)	0.28 (0.011)	0.48 (0.019)	1.37 (0.054)	1.80 (0.071)	0.25 (0.010)	0.75 (0.030)	0.076 (0.003)	-	-	-	-	-	-	S2
nanoSMDC110F	3.00 (0.118)	3.40 (0.134)	0.28 (0.011)	0.67 (0.026)	1.37 (0.054)	1.80 (0.071)	0.25 (0.010)	0.75 (0.030)	0.076 (0.003)	-	-	-	-	-	-	S2
nanoSMDC150F	3.00 (0.118)	3.40 (0.134)	0.55 (0.022)	0.89 (0.035)	1.37 (0.054)	1.80 (0.071)	0.25 (0.010)	0.75 (0.030)	0.076 (0.003)	-	-	-	-	-	-	S2
<b>coming soon</b> nanoSMDC200F*	3.00 (0.118)	3.40 (0.134)	0.68 (0.027)	1.25 (0.049)	1.37 (0.054)	1.80 (0.071)	0.25 (0.010)	0.75 (0.030)	0.076 (0.003)	-	-	-	-	-	-	S2
<b>■ microSMD Series</b>																
<b>Size 3225 mm/1210 mils</b>																
microSMD005F	3.0 (0.118)	3.43 (0.135)	0.50 (0.019)	0.85 (0.034)	2.35 (0.092)	2.80 (0.110)	0.25 (0.010)	0.75 (0.030)	0.076 (0.003)	-	-	-	-	-	-	S3
microSMD010F	3.0 (0.118)	3.43 (0.135)	0.50 (0.019)	0.85 (0.034)	2.35 (0.092)	2.80 (0.110)	0.25 (0.010)	0.75 (0.030)	0.076 (0.003)	-	-	-	-	-	-	S2
microSMD035F	3.0 (0.118)	3.43 (0.135)	0.38 (0.015)	0.62 (0.025)	2.35 (0.092)	2.80 (0.110)	0.25 (0.010)	0.75 (0.030)	0.076 (0.003)	-	-	-	-	-	-	S2
microSMD050F	3.0 (0.118)	3.43 (0.135)	0.38 (0.015)	0.62 (0.025)	2.35 (0.092)	2.80 (0.110)	0.25 (0.010)	0.75 (0.030)	0.076 (0.003)	-	-	-	-	-	-	S2
microSMD075F	3.0 (0.118)	3.43 (0.135)	0.38 (0.015)	0.62 (0.025)	2.35 (0.092)	2.80 (0.110)	0.25 (0.010)	0.75 (0.030)	0.076 (0.003)	-	-	-	-	-	-	S2
microSMD110F	3.0 (0.118)	3.43 (0.135)	0.28 (0.011)	0.48 (0.019)	2.35 (0.092)	2.80 (0.110)	0.25 (0.010)	0.75 (0.030)	0.076 (0.003)	-	-	-	-	-	-	S2
microSMD150F	3.0 (0.118)	3.43 (0.135)	0.51 (0.020)	1.22 (0.048)	2.35 (0.092)	2.80 (0.110)	0.25 (0.010)	0.75 (0.030)	0.076 (0.003)	-	-	-	-	-	-	S2
microSMD175F	3.0 (0.118)	3.43 (0.135)	0.40 (0.016)	0.76 (0.030)	2.35 (0.092)	2.80 (0.110)	0.25 (0.010)	0.75 (0.030)	0.076 (0.003)	-	-	-	-	-	-	S2
<b>NEW</b> microSMD200F	3.0 (0.118)	3.43 (0.135)	0.79 (0.031)	1.17 (0.046)	2.35 (0.092)	2.80 (0.110)	0.25 (0.010)	0.75 (0.030)	0.076 (0.003)	-	-	-	-	-	-	S2
<b>■ miniSMDC Series</b>																
<b>Size 4532 mm/1812 mils</b>																
miniSMDC014F	4.37 (0.172)	4.73 (0.186)	0.635 (0.025)	0.89 (0.035)	3.07 (0.121)	3.41 (0.134)	0.25 (0.010)	0.95 (0.040)	0.20 (0.008)	-	-	-	-	-	-	S2
miniSMDC020F	4.37 (0.172)	4.73 (0.186)	0.635 (0.025)	0.89 (0.035)	3.07 (0.121)	3.41 (0.134)	0.25 (0.010)	0.95 (0.040)	0.20 (0.008)	-	-	-	-	-	-	S2
miniSMDC050F	4.37 (0.172)	4.73 (0.186)	0.38 (0.015)	0.62 (0.025)	3.07 (0.121)	3.41 (0.134)	0.25 (0.010)	0.95 (0.040)	0.20 (0.008)	-	-	-	-	-	-	S2
miniSMDC075F	4.37 (0.172)	4.73 (0.186)	0.38 (0.015)	0.62 (0.025)	3.07 (0.121)	3.41 (0.134)	0.25 (0.010)	0.95 (0.040)	0.20 (0.008)	-	-	-	-	-	-	S2
miniSMDC075F/24	4.37 (0.172)	4.83 (0.190)	0.81 (0.032)	1.46 (0.057)	3.07 (0.121)	3.41 (0.134)	0.25 (0.010)	0.95 (0.040)	0.20 (0.008)	-	-	-	-	-	-	S2
miniSMDC110F	4.37 (0.172)	4.73 (0.186)	0.38 (0.015)	0.62 (0.025)	3.07 (0.121)	3.41 (0.134)	0.25 (0.010)	0.95 (0.040)	0.20 (0.008)	-	-	-	-	-	-	S2
miniSMDC110F/16	4.37 (0.172)	4.83 (0.190)	0.28 (0.011)	0.48 (0.019)	3.07 (0.121)	3.41 (0.134)	0.25 (0.010)	0.95 (0.040)	0.20 (0.008)	-	-	-	-	-	-	S2
miniSMDC110F/24	4.37 (0.172)	4.83 (0.190)	0.81 (0.032)	1.46 (0.057)	3.07 (0.121)	3.41 (0.134)	0.25 (0.010)	0.95 (0.040)	0.20 (0.008)	-	-	-	-	-	-	S2
miniSMDC125F	4.37 (0.172)	4.73 (0.186)	0.28 (0.011)	0.48 (0.019)	3.07 (0.121)	3.41 (0.134)	0.25 (0.010)	0.95 (0.040)	0.20 (0.008)	-	-	-	-	-	-	S2
miniSMDC125F/16	4.37 (0.172)	4.83 (0.190)	0.28 (0.011)	0.48 (0.019)	3.07 (0.121)	3.41 (0.134)	0.25 (0.010)	0.95 (0.040)	0.20 (0.008)	-	-	-	-	-	-	S2
miniSMDC150F	4.37 (0.172)	4.73 (0.186)	0.28 (0.011)	0.48 (0.019)	3.07 (0.121)	3.41 (0.134)	0.25 (0.010)	0.95 (0.040)	0.20 (0.008)	-	-	-	-	-	-	S2
miniSMDC150F/12	4.37 (0.172)	4.83 (0.190)	0.28 (0.011)	0.48 (0.019)	3.07 (0.121)	3.41 (0.134)	0.25 (0.010)	0.95 (0.040)	0.20 (0.008)	-	-	-	-	-	-	S2

\* Data is preliminary

**Table S4 Dimensions for Surface-mount Devices in Millimeters (Inches)**

... Cont'd

Part Number	A		B		C		D		E		F		G		H		Figure
	min	max	min	max	min	max	min	max	min	max	min	max	min	max	min	max	
<b>miniSMDC Series</b>																	
<b>Size 4532 mm/1812 mils</b>																	
miniSMDC150F/24	4.37 (0.172)	4.83 (0.190)	1.00 (0.040)	1.94 (0.077)	3.07 (0.121)	3.41 (0.134)	0.25 (0.010)	0.95 (0.040)	0.20 (0.008)	-	-	-	-	-	-	-	S2
miniSMDC160F	4.37 (0.172)	4.73 (0.186)	0.28 (0.011)	0.48 (0.019)	3.07 (0.121)	3.41 (0.134)	0.25 (0.010)	0.95 (0.040)	0.20 (0.008)	-	-	-	-	-	-	-	S2
miniSMDC200F	4.37 (0.172)	4.73 (0.186)	0.51 (0.020)	1.22 (0.048)	3.07 (0.121)	3.41 (0.134)	0.25 (0.010)	0.95 (0.040)	0.20 (0.008)	-	-	-	-	-	-	-	S2
miniSMDC260F	4.37 (0.172)	4.73 (0.186)	0.48 (0.019)	0.78 (0.031)	3.07 (0.121)	3.41 (0.134)	0.25 (0.010)	0.95 (0.040)	0.20 (0.008)	-	-	-	-	-	-	-	S2
miniSMDC260F/12	4.37 (0.172)	4.83 (0.190)	0.76 (0.030)	1.25 (0.050)	3.07 (0.121)	3.41 (0.134)	0.25 (0.010)	0.95 (0.040)	0.20 (0.008)	-	-	-	-	-	-	-	S2
miniSMDC260F/13.2	4.37 (0.172)	4.83 (0.190)	1.02 (0.042)	1.52 (0.060)	3.07 (0.121)	3.41 (0.134)	0.25 (0.010)	0.95 (0.040)	0.20 (0.008)	-	-	-	-	-	-	-	S2
<b>NEW</b> miniSMDC260F/16	4.37 (0.172)	4.83 (0.190)	1.02 (0.042)	1.52 (0.060)	3.07 (0.121)	3.41 (0.134)	0.25 (0.010)	0.95 (0.040)	0.20 (0.008)	-	-	-	-	-	-	-	S2
<b>miniSMDE Series</b>																	
<b>Size 11550 mm/4420 mils</b>																	
miniSMDE190F	11.15 (0.439)	11.51 (0.453)	0.33 (0.013)	0.53 (0.021)	4.83 (0.190)	5.33 (0.210)	0.51 (0.020)	1.02 (0.040)	0.381 (0.015)	-	-	-	-	-	-	-	S2
<b>midSMD Series</b>																	
<b>Size 5050 mm/2018 mils</b>																	
SMD030F-2018	4.72 (0.186)	5.44 (0.214)	-	1.78 (0.070)	4.22 (0.166)	4.93 (0.194)	0.25 (0.010)	0.36 (0.014)	0.25 (0.010)	0.36 (0.014)	0.30 (0.012)	0.46 (0.018)	-	-	-	-	S4
decaSMDC050F/60	4.70 (0.185)	5.31 (0.209)	0.63 (0.025)	0.89 (0.035)	4.19 (0.165)	4.81 (0.189)	0.25 (0.010)	0.95 (0.040)	0.25 (0.010)	-	-	-	-	-	-	-	S2
SMD100F-2018	4.72 (0.186)	5.44 (0.214)	-	1.52 (0.060)	4.22 (0.166)	4.93 (0.194)	0.25 (0.010)	0.36 (0.014)	0.25 (0.010)	0.36 (0.014)	0.30 (0.012)	0.46 (0.018)	-	-	-	-	S4
SMD150F-2018	4.72 (0.186)	5.44 (0.214)	-	1.52 (0.060)	4.22 (0.166)	4.93 (0.194)	0.25 (0.010)	0.36 (0.014)	0.25 (0.010)	0.36 (0.014)	0.30 (0.012)	0.46 (0.018)	-	-	-	-	S4
SMD200F-2018	4.72 (0.186)	5.44 (0.214)	-	1.52 (0.060)	4.22 (0.166)	4.93 (0.194)	0.25 (0.010)	0.36 (0.014)	0.25 (0.010)	0.36 (0.014)	0.30 (0.012)	0.46 (0.018)	-	-	-	-	S4
<b>SMD Series</b>																	
<b>Size 7555 mm/2920 mils</b>																	
SMD030F	6.73 (0.265)	7.98 (0.314)	-	3.18 (0.125)	4.80 (0.19)	5.44 (0.214)	0.56 (0.022)	0.71 (0.028)	0.56 (0.022)	0.71 (0.028)	2.16 (0.085)	2.41 (0.095)	0.66 (0.026)	1.37 (0.054)	0.43 (0.017)	-	S5
SMD050F	6.73 (0.265)	7.98 (0.314)	-	3.18 (0.125)	4.80 (0.19)	5.44 (0.214)	0.56 (0.022)	0.71 (0.028)	0.20 (0.008)	0.30 (0.012)	2.16 (0.085)	2.41 (0.095)	0.66 (0.026)	1.37 (0.054)	0.43 (0.017)	-	S5
SMD075F	6.73 (0.265)	7.98 (0.314)	-	3.18 (0.125)	4.80 (0.19)	5.44 (0.214)	0.56 (0.022)	0.71 (0.028)	0.56 (0.022)	0.71 (0.028)	2.16 (0.085)	2.41 (0.095)	0.66 (0.026)	1.37 (0.054)	0.43 (0.017)	-	S5
SMD075F/60	6.73 (0.265)	7.98 (0.314)	-	3.18 (0.125)	4.80 (0.19)	5.44 (0.214)	0.56 (0.022)	0.71 (0.028)	0.56 (0.022)	0.71 (0.028)	2.16 (0.085)	2.41 (0.095)	0.66 (0.026)	1.37 (0.054)	0.43 (0.017)	-	S5
SMD100F	6.73 (0.265)	7.98 (0.314)	-	3.00 (0.118)	4.80 (0.19)	5.44 (0.214)	0.56 (0.022)	0.71 (0.028)	0.56 (0.022)	0.71 (0.028)	2.16 (0.085)	2.41 (0.095)	0.66 (0.026)	1.37 (0.054)	0.43 (0.017)	-	S5
SMD100F/33	6.73 (0.265)	7.98 (0.314)	-	3.00 (0.118)	4.80 (0.19)	5.44 (0.214)	0.56 (0.022)	0.71 (0.028)	0.56 (0.022)	0.71 (0.028)	2.16 (0.085)	2.41 (0.095)	0.66 (0.026)	1.37 (0.054)	0.43 (0.017)	-	S5
SMDH120	6.73 (0.265)	7.98 (0.314)	-	3.00 (0.118)	4.80 (0.19)	5.44 (0.214)	0.56 (0.022)	0.71 (0.028)	0.56 (0.022)	0.71 (0.028)	2.16 (0.085)	2.41 (0.095)	0.66 (0.026)	1.37 (0.054)	0.43 (0.017)	-	S5
SMD125F	6.73 (0.265)	7.98 (0.314)	-	3.00 (0.118)	4.80 (0.19)	5.44 (0.214)	0.56 (0.022)	0.71 (0.028)	0.56 (0.022)	0.71 (0.028)	2.16 (0.085)	2.41 (0.095)	0.66 (0.026)	1.37 (0.054)	0.43 (0.017)	-	S5
SMD260F	6.73 (0.265)	7.98 (0.314)	-	3.00 (0.118)	4.80 (0.19)	5.44 (0.214)	0.56 (0.022)	0.71 (0.028)	0.56 (0.022)	0.71 (0.028)	2.16 (0.085)	2.41 (0.095)	0.66 (0.026)	1.37 (0.054)	0.43 (0.017)	-	S5
SMD300F	6.73 (0.265)	7.98 (0.314)	-	3.00 (0.118)	4.80 (0.19)	5.44 (0.214)	0.56 (0.022)	0.71 (0.028)	0.56 (0.022)	0.71 (0.028)	2.16 (0.085)	2.41 (0.095)	0.66 (0.026)	1.37 (0.054)	0.43 (0.017)	-	S5
<b>SMD2 Devices</b>																	
<b>Size 8763 mm/3425 mils</b>																	
SMD150F	8.00 (0.315)	9.40 (0.370)	-	3.00 (0.118)	6.00 (0.236)	6.71 (0.264)	0.56 (0.022)	0.71 (0.028)	0.56 (0.022)	0.71 (0.028)	3.68 (0.145)	3.94 (0.155)	0.66 (0.026)	1.37 (0.054)	0.43 (0.017)	-	S5
SMD150F/33	8.00 (0.315)	9.40 (0.370)	-	3.00 (0.118)	6.00 (0.236)	6.71 (0.264)	0.56 (0.022)	0.71 (0.028)	0.56 (0.022)	0.71 (0.028)	3.68 (0.145)	3.94 (0.155)	0.66 (0.026)	1.37 (0.054)	0.43 (0.017)	-	S5
SMDH160	8.00 (0.315)	9.40 (0.370)	-	3.00 (0.118)	6.00 (0.236)	6.71 (0.264)	0.56 (0.022)	0.71 (0.028)	0.56 (0.022)	0.71 (0.028)	3.68 (0.145)	3.94 (0.155)	0.66 (0.026)	1.37 (0.054)	0.43 (0.017)	-	S5
SMD185F	8.00 (0.315)	9.40 (0.370)	-	3.00 (0.118)	6.00 (0.236)	6.71 (0.264)	0.56 (0.022)	0.71 (0.028)	0.56 (0.022)	0.71 (0.028)	3.68 (0.145)	3.94 (0.155)	0.66 (0.026)	1.37 (0.054)	0.43 (0.017)	-	S5
SMD200F	8.00 (0.315)	9.40 (0.370)	-	3.00 (0.118)	6.00 (0.236)	6.71 (0.264)	0.56 (0.022)	0.71 (0.028)	0.56 (0.022)	0.71 (0.028)	3.68 (0.145)	3.94 (0.155)	0.66 (0.026)	1.37 (0.054)	0.43 (0.017)	-	S5
SMD250F	8.00 (0.315)	9.40 (0.370)	-	3.00 (0.118)	6.00 (0.236)	6.71 (0.264)	0.56 (0.022)	0.71 (0.028)	0.56 (0.022)	0.71 (0.028)	3.68 (0.145)	3.94 (0.155)	0.66 (0.026)	1.37 (0.054)	0.43 (0.017)	-	S5

14

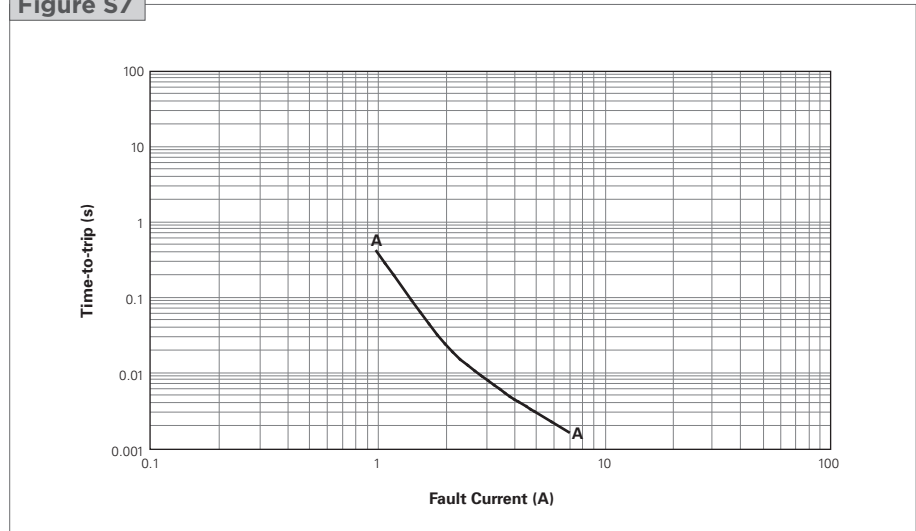

**Figure S7-S13** Typical Time-to-trip Curves at 20 °C for Surface-mount Devices

**picoSMDxxxF**

A = picoSMD035F

**Figure S7**



**nanoSMDCxxxF**

- A = nanoSMDC012F
- B = nanoSMDC016F
- C = nanoSMDC020F
- D = nanoSMDC035F
- E = nanoSMDC050F/13.2
- F = nanoSMDC075F
- G = nanoSMDC110F
- H = nanoSMDC150F

**Figure S8**

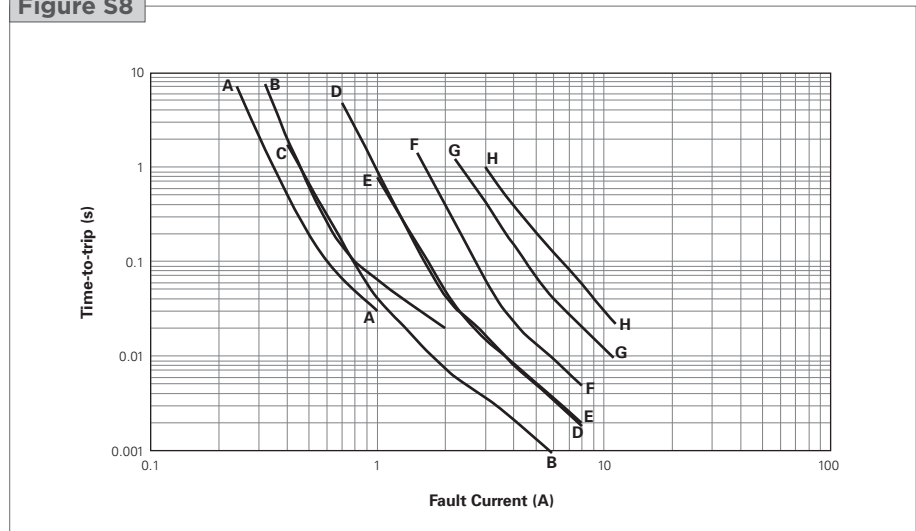

**microSMDxxxF**

- A = microSMD005F
- B = microSMD010F
- C = microSMD035F
- D = microSMD050F
- E = microSMD075F
- F = microSMD110F
- G = microSMD150F
- H = microSMD175F
- I = microSMD200F

**Figure S9**

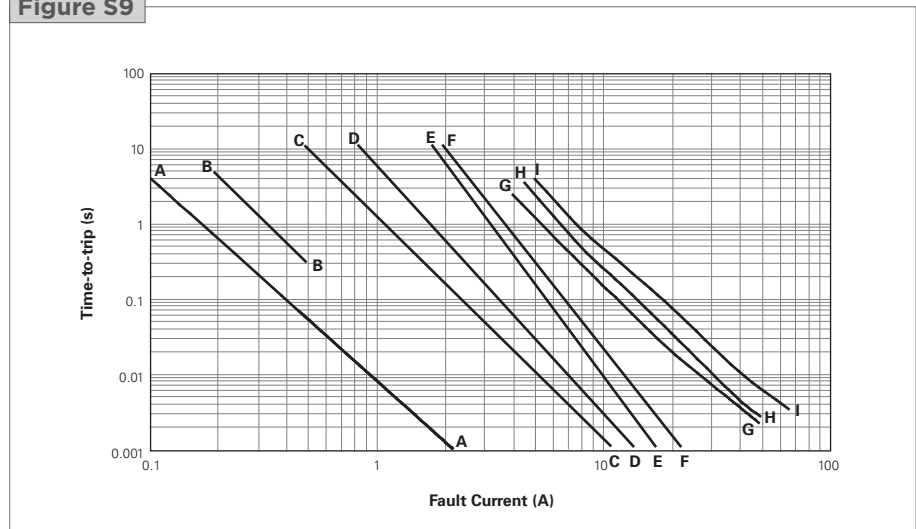
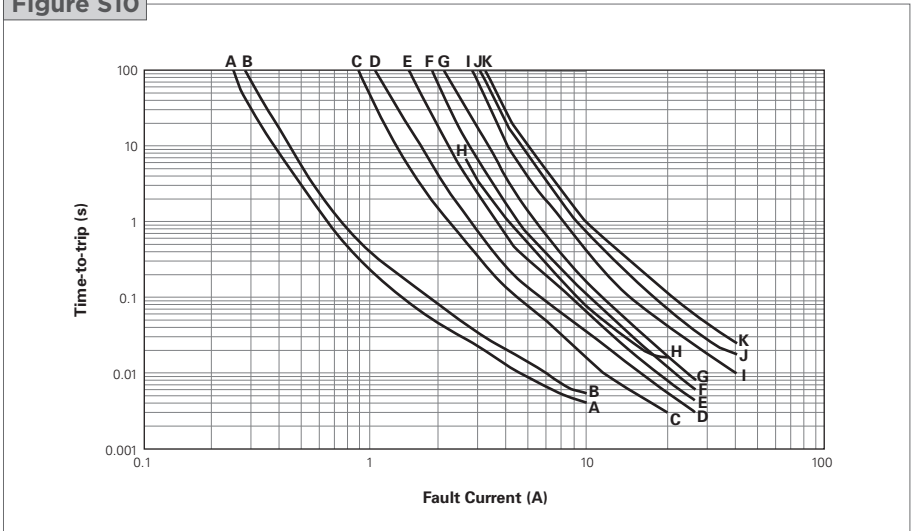

Figure S7-S13 Typical Time-to-trip Curves at 20 °C for Surface-mount Devices ... Cont'd

**miniSMDCxxxF and miniSMDExxxF**

- A = miniSMDC014F
- B = miniSMDC020F
- C = miniSMDC050F
- D = miniSMDC075F, miniSMDC075F/24
- E = miniSMDC110F, miniSMDC110F/16, miniSMDC110F/24
- F = miniSMDC125F, miniSMDC125F/16
- G = miniSMDC150F, miniSMDC150F/12, miniSMDC150F/24
- H = miniSMDC160F
- I = miniSMDC200F
- J = miniSMDE190F
- K = miniSMDC260F, miniSMDC260F/12, miniSMDC260F/13.2, miniSMDC260F/16

Figure S10



**midSMD**

- A = SMD030F-2018
- B = decaSMD050F/60
- C = SMD100F-2018
- D = SMD150F-2018
- E = SMD200F-2018

Figure S11

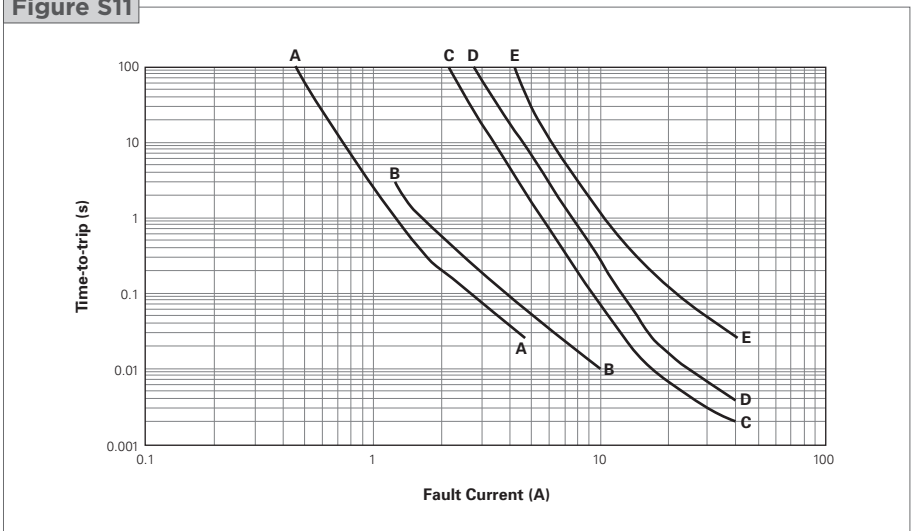

**SMDxxxF**

- A = SMD030F
- B = SMD050F
- C = SMD075F, SMD075F/60
- D = SMDH120
- E = SMD100F, SMD100F/33
- F = SMD125F
- G = SMD260F
- H = SMD300F

Figure S12

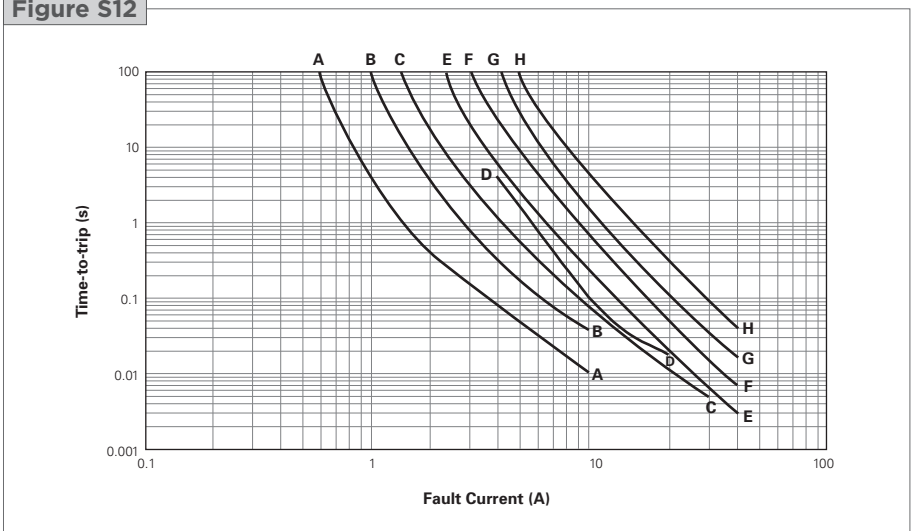

**Figure S7-S13 Typical Time-to-trip Curves at 20 °C for Surface-mount Devices**

... Cont'd

**SMD2xxxF**

- A = SMD150F, SMD150F/33
- B = SMDH160
- C = SMD185F
- D = SMD200F
- E = SMD250F

**Figure S13**

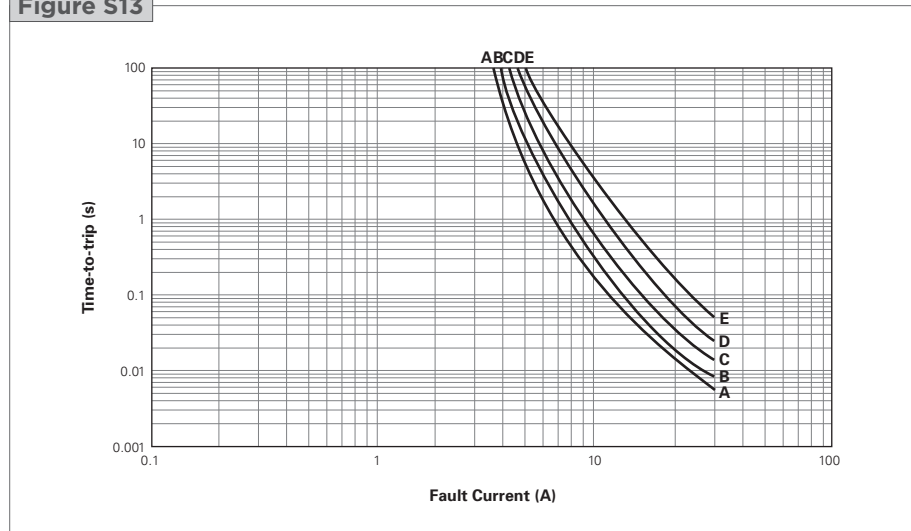

**Table S5 Physical Characteristics and Environmental Specifications for Surface-mount Devices**  
Operating temperature range -40°C to 85°C, -40°C to 125°C for SMDH120 and SMDH160

**Physical Characteristics**

Terminal pad material	100% matte tin with nickel underplate; gold with nickel underplate for picoSMD
Soldering characteristics	ANSI/J-STD-002 Category 3 for picoSMD, nanoSMD, microSMD and miniSMD series ANSI/J-STD-002 Category 1 for SMD series
Solder heat withstand	per IEC-STD 68-2-20, Test Tb, Section 5, Method 1A
Flammability resistance	per IEC 695-2-2 Needle Flame Test for 20 sec.
Recommended storage conditions	40°C max, 70% R.H. max; devices may not meet specified ratings if storage conditions are exceeded.
Moisture sensitivity	Level 2a, per IPC/JEDEC J-STD 020C

**Environmental Specifications**

Test	Test Method	Conditions	Resistance Change
Storage Life	Raychem PS300, Section 5.3.2	60°C, 1000 hours	±3% typical
		85°C, 1000 hours	±5% typical
Humidity aging	Raychem PS300, Section 5.3.1	85°C, 85% RH, 100 hours	±1.2% typical
Thermal shock	MIL-STD-202, Method 107G	85°C, -40°C (20 times)	-33% typical
		125°C, -55°C (10 times)	-33% typical
Vibration	MIL-STD-883C	per MIL-STD-883C	No change
Solvent resistance	Raychem PS300, Section 5.2.2	Freon	No change
		Trichloroethane	No change
		Hydrocarbons	No change

**Table S6 Packaging and Marking Information for Surface-mount Devices**

... Cont'd

Part Number	Tape & Reel Quantity	Standard Package	Part Marking	Recommended Pad Layout Figures [mm(In.)]			Agency Recognition
				Dimension A (Nom.)	Dimension B (Nom.)	Dimension C (Nom.)	
<b>picoSMD Series</b> Size 2012 mm/0805 mils							
<b>NEW</b> picoSMD035F	4,000	20,000	TBD	1.50 (0.060)	1.17(0.046)	1.00(0.040)	UL, CSA, TÜV
<b>nanoSMDC Series</b> Size 3216 mm/1206 mils							
nanoSMDC012F	3,000	15,000	P	1.60 (0.063)	1.00 (0.039)	2.00 (0.079)	UL, CSA
nanoSMDC016F	3,000	15,000	N	1.60 (0.063)	1.00 (0.039)	2.00 (0.079)	UL, CSA, TÜV
nanoSMDC020F	3,000	15,000	02	1.60 (0.063)	1.00 (0.039)	2.00 (0.079)	UL, CSA, TÜV
nanoSMDC035F	3,000	15,000	03	1.60 (0.063)	1.00 (0.039)	2.00 (0.079)	UL, CSA, TÜV
nanoSMDC050F/13.2	3,000	15,000	M	1.60 (0.063)	1.00 (0.039)	2.00 (0.079)	UL, CSA, TÜV
nanoSMDC075F	3,000	15,000	L	1.60 (0.063)	1.00 (0.039)	2.00 (0.079)	UL, CSA, TÜV
nanoSMDC110F	3,000	15,000	K	1.60 (0.063)	1.00 (0.039)	2.00 (0.079)	UL, CSA, TÜV
nanoSMDC150F	3,000	15,000	15	1.60 (0.063)	1.00 (0.039)	2.00 (0.079)	UL, CSA, TÜV
<b>coming soon</b> nanoSMDC200F*	TBD	TBD	TBD	1.60 (0.063)	1.00 (0.039)	2.00 (0.079)	Pending
<b>microSMD Series</b> Size 3225 mm/1210 mils							
microSMD005F	4,000	20,000	05	2.50 (0.098)	1.00 (0.039)	2.00 (0.079)	UL, CSA, TÜV
microSMD010F	4,000	20,000	10	2.50 (0.098)	1.00 (0.039)	2.00 (0.079)	UL, CSA, TÜV
microSMD035F	4,000	20,000	3	2.50 (0.098)	1.00 (0.039)	2.00 (0.079)	UL, CSA, TÜV
microSMD050F	4,000	20,000	50	2.50 (0.098)	1.00 (0.039)	2.00 (0.079)	UL, CSA, TÜV
microSMD075F	4,000	20,000	75	2.50 (0.098)	1.00 (0.039)	2.00 (0.079)	UL, CSA, TÜV
microSMD110F	4,000	20,000	11	2.50 (0.098)	1.00 (0.039)	2.00 (0.079)	UL, CSA, TÜV
microSMD150F	4,000	20,000	15	2.50 (0.098)	1.00 (0.039)	2.00 (0.079)	UL, CSA, TÜV
microSMD175F	4,000	20,000	17	2.50 (0.098)	1.00 (0.039)	2.00 (0.079)	UL, CSA, TÜV
<b>NEW</b> microSMD200F	3,000	15,000	20	2.50 (0.098)	1.00 (0.039)	2.00 (0.079)	UL, CSA, TÜV
<b>miniSMDC Series</b> Size 4532 mm/1812 mils							
miniSMDC014F	2,000	10,000	14	2.95 (0.114)	1.68 (0.066)	3.10 (0.122)	UL, CSA, TÜV
miniSMDC020F	2,000	10,000	2	2.95 (0.114)	1.68 (0.066)	3.10 (0.122)	UL, CSA, TÜV
miniSMDC050F	2,000	10,000	5	2.95 (0.114)	1.68 (0.066)	3.10 (0.122)	UL, CSA, TÜV
miniSMDC075F	2,000	10,000	7	2.95 (0.114)	1.68 (0.066)	3.10 (0.122)	UL, CSA, TÜV
miniSMDC075F/24	1,500	7,500	075F 24V	2.95 (0.114)	1.68 (0.066)	3.10 (0.122)	UL, CSA, TÜV
miniSMDC110F	2,000	10,000	1	2.95 (0.114)	1.68 (0.066)	3.10 (0.122)	UL, CSA, TÜV
miniSMDC110F/16	2,000	10,000	110F 16V	2.95 (0.114)	1.68 (0.066)	3.10 (0.122)	UL, CSA, TÜV
miniSMDC110F/24	1,500	7,500	110F 24V	2.95 (0.114)	1.68 (0.066)	3.10 (0.122)	UL, CSA, TÜV
miniSMDC125F	2,000	10,000	12	2.95 (0.114)	1.68 (0.066)	3.10 (0.122)	UL, CSA, TÜV
miniSMDC125F/16	2,000	10,000	125F 16V	2.95 (0.114)	1.68 (0.066)	3.10 (0.122)	UL, CSA, TÜV
miniSMDC150F	2,000	10,000	15	2.95 (0.114)	1.68 (0.066)	3.10 (0.122)	UL, CSA, TÜV
miniSMDC150F/12	2,000	10,000	150F 12V	2.95 (0.114)	1.68 (0.066)	3.10 (0.122)	UL, CSA, TÜV
miniSMDC150F/24	1,000	5,000	150F 24V	2.95 (0.114)	1.68 (0.066)	3.10 (0.122)	UL, CSA, TÜV
miniSMDC160F	2,000	10,000	16	2.95 (0.114)	1.68 (0.066)	3.10 (0.122)	UL, CSA, TÜV
miniSMDC200F	2,000	10,000	20	2.95 (0.114)	1.68 (0.066)	3.10 (0.122)	UL, CSA, TÜV
miniSMDC260F	2,000	10,000	260F	2.95 (0.114)	1.68 (0.066)	3.10 (0.122)	UL, CSA, TÜV
miniSMDC260F/12	1,500	7,500	260F 12V	2.95 (0.114)	1.68 (0.066)	3.10 (0.122)	UL, CSA, TÜV
miniSMDC260F/13.2	1,500	7,500	260F 13.2	2.95 (0.114)	1.68 (0.066)	3.10 (0.122)	UL, CSA, TÜV
<b>NEW</b> miniSMDC260F/16	1,500	7,500	260F 16V	2.95 (0.114)	1.68 (0.066)	3.10 (0.122)	UL, CSA, TÜV
<b>miniSMDE Series</b> Size 11550 mm/4420 mils							
miniSMDE190F	5,000	20,000	19	4.75 (0.187)	1.45 (0.057)	9.57 (0.377)	UL, CSA, TÜV
<b>midSMD Series</b> Size 5050 mm/2018 mils							
SMD030F-2018	4,000	20,000	A03F	4.60 (0.18)	1.50 (0.059)	3.40 (0.134)	UL, CSA, TÜV
decaSMDC050F/60	1,000	5,000	050F 60V	4.32 (0.17)	1.40 (0.055)	3.61 (0.142)	UL, CSA, TÜV
SMD100F-2018	4,000	20,000	A10F	4.60 (0.18)	1.50 (0.059)	3.40 (0.134)	UL, CSA, TÜV
SMD150F-2018	4,000	20,000	A15F	4.60 (0.18)	1.50 (0.059)	3.40 (0.134)	UL, CSA, TÜV
SMD200F-2018	4,000	20,000	A20F	4.60 (0.18)	1.50 (0.059)	3.40 (0.134)	UL, CSA, TÜV

\* Data is preliminary

**Table S6 Packaging and Marking Information for Surface-mount Devices** ... Cont'd

Part Number	Tape & Reel Quantity	Standard Package	Part Marking	Recommended Pad Layout Figures [mm(In.)]			Agency Recognition
				Dimension A (Nom.)	Dimension B (Nom.)	Dimension C (Nom.)	
<b>SMD Series</b>							
<b>Size 7555 mm/2920 mils</b>							
SMD030F	2,000	10,000	030F	3.10 (0.12)	2.30 (0.09)	5.10 (0.201)	UL, CSA, TÜV
SMD050F	2,000	10,000	050F	3.10 (0.12)	2.30 (0.09)	5.10 (0.201)	UL, CSA, TÜV
SMD075F	2,000	10,000	075F	3.10 (0.12)	2.30 (0.09)	5.10 (0.201)	UL, CSA, TÜV
SMD075F/60	2,000	10,000	756F	3.10 (0.12)	2.30 (0.09)	5.10 (0.201)	UL, CSA, TÜV
SMD100F	2,000	10,000	100F	3.10 (0.12)	2.30 (0.09)	5.10 (0.201)	UL, CSA, TÜV
SMD100F/33	2,000	10,000	103F	3.10 (0.12)	2.30 (0.09)	5.10 (0.201)	UL, CSA, TÜV
SMDH120	2,000	10,000	H12	3.10 (0.12)	2.30 (0.09)	5.10 (0.201)	UL, CSA
SMD125F	2,000	10,000	125F	3.10 (0.12)	2.30 (0.09)	5.10 (0.201)	UL, CSA, TÜV
SMD260F	2,000	10,000	260F	3.10 (0.12)	2.30 (0.09)	5.10 (0.201)	UL, CSA, TÜV
SMD300F	2,000	10,000	300F	3.10 (0.12)	2.30 (0.09)	5.10 (0.201)	UL, CSA, TÜV
<b>SMD2 Devices</b>							
<b>Size 8763 mm/3425 mils</b>							
SMD150F	1,500	7,500	150F	4.60 (0.18)	2.30 (0.09)	6.10 (0.240)	UL, CSA, TÜV
SMD150F/33	1,500	7,500	153F	4.60 (0.18)	2.30 (0.09)	6.10 (0.240)	UL, CSA, TÜV
SMDH160	1,500	7,500	160F	4.60 (0.18)	2.30 (0.09)	6.10 (0.240)	UL, CSA
SMD185F	1,500	7,500	185F	4.60 (0.18)	2.30 (0.09)	6.10 (0.240)	UL, CSA, TÜV
SMD200F	1,500	7,500	200F	4.60 (0.18)	2.30 (0.09)	6.10 (0.240)	UL, CSA, TÜV
SMD250F	1,500	7,500	250F	4.60 (0.18)	2.30 (0.09)	6.10 (0.240)	UL, CSA, TÜV

**Figure S14 Recommended Pad Layout for Surface-mount Devices**



**Agency Recognition for Surface-mount Devices**

UL	File # E74889 for all surface-mount devices
CSA	File # CA78165 for all surface-mount devices
TÜV	Certificate # R72072068 for picoSMD series
	Certificate # R72041439 for nanoSMD series
	Certificate # R72041438 for microSMD and miniSMD series
	Certificate # R72041867 for decaSMD series
	Certificate # R72041427 for SMD series
	Certificate # R72072048 for SMDH series

## Solder Reflow and Rework Recommendation for Surface-mount Devices

### Classification Reflow Profiles

Profile Feature	Sn-Pb Eutectic Assembly	Pb-Free Assembly
Average Ramp-Up Rate ( $T_{s_{max}}$ to $T_p$ )	3°C/second max.	3°C/second max.
<b>Preheat</b>		
• Temperature Min ( $T_{s_{min}}$ )	100°C	150°C
• Temperature Max ( $T_{s_{max}}$ )	150°C	200°C
• Time ( $t_{s_{min}}$ to $t_{s_{max}}$ )	60-120 seconds	60-180 seconds
<b>Time maintained above:</b>		
• Temperature ( $T_L$ )	183°C	217°C
• Time ( $t_L$ )	60-150 seconds	60-150 seconds
<b>Peak/Classification Temperature (<math>T_p</math>)</b>	260°C	260°C
<b>Time within 5°C of actual Peak</b>		
Temperature ( $t_p$ )	10-30 seconds	20-40 seconds
<b>Ramp-Down Rate</b>	6°C/second max.	6°C/second max.
<b>Time 25°C to Peak Temperature</b>	6 minutes max.	8 minutes max.

**Note:** All temperatures refer to topside of the package, measured on the package body surface.

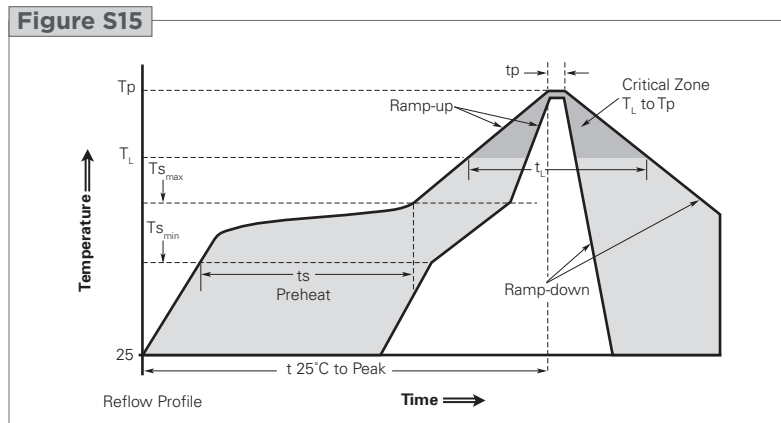

### Solder Reflow

- Recommended reflow methods:
  - IR
  - Hot air
  - Nitrogen
- Recommended maximum paste thickness:
  - picoSMD, nanoSMD, microSMD and miniSMD series: 0.25mm (0.010 inch)
  - SMD series: 0.38mm (0.015 inch)
- Devices can be cleaned using standard methods and aqueous solvents.
- We believe the optimum conditions for forming acceptable solder fillets occur when a reasonable amount of solder paste is placed underneath each device's via. As such, we request that customers comply with our recommended solder pad layouts.
- We request that customer board layouts refrain from placing raised features (e.g. vias, nomenclature, traces, etc.) underneath PolySwitch devices. It is possible that raised features could negatively impact solderability performance of our devices.

### Rework

- picoSMD, nanoSMD, microSMD and miniSMD series: standard industry practices. Please also avoid direct contact to the device.
- SMD series: rework should be confined to removal of the installed product and replacement with a fresh device.

**Table S7** Tape and Reel Specifications for Surface-mount Devices (in Millimeters)

Description	picoSMDC EIA 481-1	nanoSMDC EIA 481-1	microSMD EIA 481-1	miniSMDC EIA 481-1	miniSMDE190 EIA 481-2	midSMD EIA 481-2	SMD EIA 481-2	SMD2 EIA 481-2
W	8.0 ± 0.30	8.0 ± 0.30	8.0 ± 0.30	12.0 ± 0.30	24.0 ± 0.30	16.0 ± 0.30	16.0 ± 0.30	16.0 ± 0.30
P <sub>0</sub>	4.0 ± 0.10	4.0 ± 0.10	4.0 ± 0.10	4.0 ± 0.10	4.0 ± 0.10	4.0 ± 0.10	4.0 ± 0.10	4.0 ± 0.10
P <sub>1</sub>	4.0 ± 0.10	4.0 ± 0.10	4.0 ± 0.10	8.0 ± 0.10	8.0 ± 0.10	8.0 ± 0.10	8.0 ± 0.10	12.0 ± 0.10
P <sub>2</sub>	2.0 ± 0.05	2.0 ± 0.05	2.0 ± 0.05	2.0 ± 0.05	2.0 ± 0.10	2.0 ± 0.10	2.0 ± 0.10	2.0 ± 0.10
A <sub>0</sub>	Table S8	1.95 ± 0.10	2.9 ± 0.10	Table S8	5.70 ± 0.10	5.11 ± 0.15	5.6 ± 0.23	6.9 ± 0.23
B <sub>0</sub>	Table S8	3.50 ± 0.10	3.50 ± 0.10	Table S8	11.90 ± 0.10	5.6 ± 0.23	8.1 ± 0.15	9.6 ± 0.15
B <sub>1</sub> max.	4.35	4.35	4.35	8.2	20.1	12.1	12.1	12.1
D <sub>0</sub>	1.55 ± .05	1.55 ± .05	1.55 ± .05	1.5 + 0.10/-.00	1.55 ± .05	1.5 + 0.10/-.00	1.5 + 0.10/-.00	1.5 + 0.10/-.00
F	3.50 ± 0.05	3.50 ± 0.05	3.50 ± 0.05	5.50 ± 0.05	11.50 ± 0.10	7.50 ± 0.10	7.50 ± 0.10	7.50 ± 0.10
E <sub>1</sub>	1.75 ± 0.10	1.75 ± 0.10	1.75 ± 0.10	1.75 ± 0.10	1.75 ± 0.10	1.75 ± 0.10	1.75 ± 0.10	1.75 ± 0.10
E <sub>2</sub> min.	6.25	6.25	6.25	10.25	22.25	14.25	14.25	14.25
T max.	0.6	0.6	0.6	0.6	0.6	0.6	0.6	0.6
T <sub>1</sub> max.	0.1	0.1	0.1	0.1	0.1	0.1	0.1	0.1
K <sub>0</sub>	Table S8	0.89 ± 0.10	Table S8	Table S8	0.95 ± 0.10	1.8 ± 0.15	3.2 ± 0.15	3.4 ± 0.15
Leader min.	390	390	390	390	400	400	400	400
Trailer min.	160	160	160	160	160	160	160	160

**Table S8** Tape and Reel Specifications for Surface-mount Devices (in Millimeters)

	All nanoSMD series except		All microSMD series except		All miniSMD series and miniSMDC200F	miniSMDC075F/24 miniSMDC110F/24 miniSMDC260F/12 miniSMDC260F/13.2		miniSMDC150F/24	decaSMDC050F/60
	picoSMD035F	nanoSMDC150F	nanoSMDC150F	microSMD200F		miniSMDC260F	miniSMDC260F/16		
A <sub>0</sub>	1.70 ± 0.1	1.95 ± 0.1	1.95 ± 0.10	2.9 ± 0.1	2.90 ± 0.1	3.5 ± 0.1	3.7 ± 0.1	3.70 ± 0.1	5.0 ± 0.1
B <sub>0</sub>	2.45 ± 0.1	3.50 + 0.1/-0.08	3.53 ± 0.07	3.5 ± 0.1	3.50 ± 0.1	5.1 ± 0.1	4.9 ± 0.1	4.90 ± 0.1	5.4 ± 0.1
K <sub>0</sub>	0.86 ± 0.1	0.89 ± 0.1	0.94 ± 0.05	0.9 ± 0.1	1.27 ± 0.1	0.9 ± 0.1	1.4 ± 0.1	1.78 ± 0.1	1.7 ± 0.1

**Table S9** Reel Dimensions for Surface-mount Devices (in Millimeters)

	pico/nano/microSMD	miniSMDC	miniSMDE190	midSMD	SMD	SMD2
A max.	185	185	330	330	330	330
N min.	50	50	60	50	50	50
W <sub>1</sub>	8.4 + 1.5/-0.00	12.4 + 2.0/-0.00	24.4 + 2.0/-0.00	16.4 + 2.0/-0.00	16.4 + 2.0/-0.00	16.4 + 2.0/-0.00
W <sub>2</sub> max.	14.4	18.4	30.4	22.4	22.4	22.4

**Figure S16** EIA Taped Component Dimensions for Surface-mount Devices

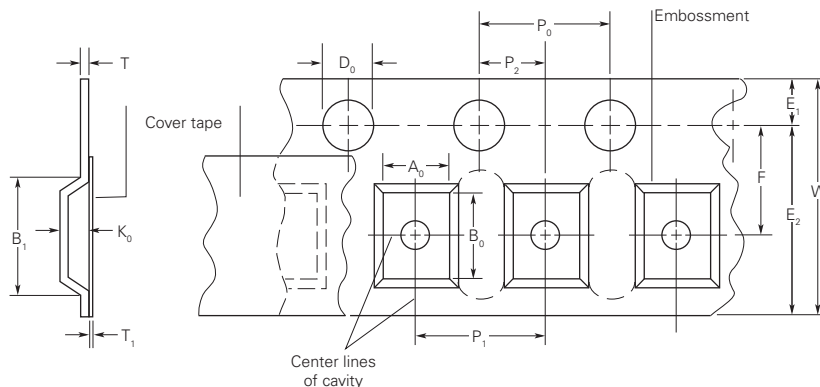

**Figure S17 EIA Reel Dimensions for Surface-mount Devices**

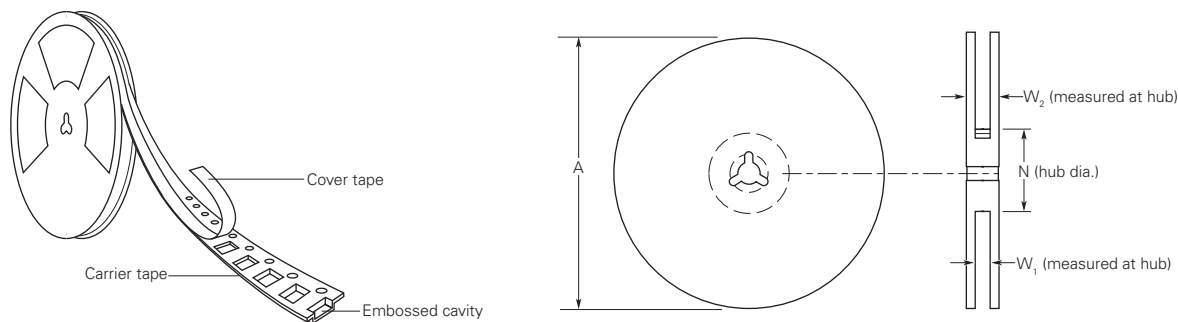

**Part Numbering System for Surface-mount Devices**

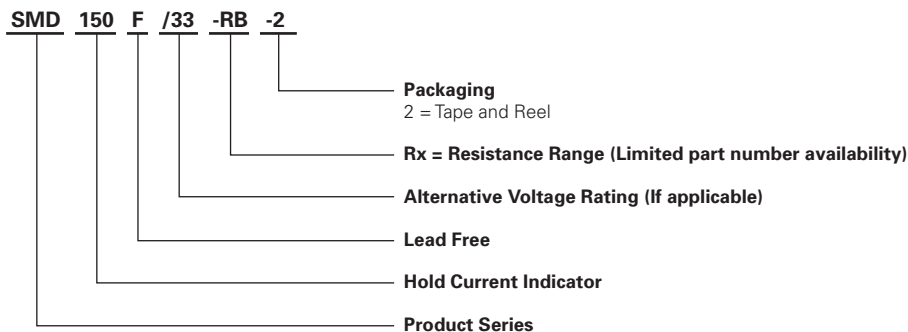

**Warning :**

- Operation beyond the maximum ratings or improper use may result in device damage and possible electrical arcing and flame.
- The devices are intended for protection against occasional overcurrent or overtemperature fault conditions and should not be used when repeated fault conditions or prolonged trip events are anticipated.
- Contamination of the PPTC material with certain silicon based oils or some aggressive solvents can adversely impact the performance of the devices.
- Device performance can be impacted negatively if devices are handled in a manner inconsistent with recommended electronic, thermal, and mechanical procedures for electronic components.
- Operation in circuit with a large inductance can generate a circuit voltage (L di/dt) above the rated voltage of the PolySwitch resettable device.