

$$I_{F(AV)} = 2 \text{ Amp}$$

$$V_R = 100V$$

Major Ratings and Characteristics

Characteristics	Values	Units
$I_{F(AV)}$ Rectangular waveform	2.0	A
V_{RRM}	100	V
I_{FSM} @ $t_p = 5 \mu s$ sine	380	A
V_F @ 1 Apk, $T_J = 125^\circ C$ (per leg)	0.67	V
T_J range	-55 to 175	$^\circ C$

Description/ Features

The 20CJQ100 surface mount Schottky rectifier series has been designed for applications requiring very low forward drop and very small foot prints. Typical applications are in portables, switching power supplies, converters, automotive system, free-wheeling diodes, battery charging, and reverse battery protection.

- Small footprint, surface mountable
- Low profile
- Very low forward voltage drop
- High frequency operation
- Guard ring for enhanced ruggedness and long term reliability
- Common cathode

Case Styles



SOT-223

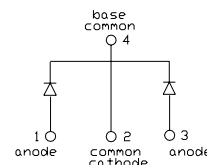

Voltage Ratings

Part number	20CJQ100
V _R Max. DC Reverse Voltage (V)	100
V _{RWM} Max. Working Peak Reverse Voltage (V)	

Absolute Maximum Ratings

Parameters	Values	Units	Conditions
I _{F(AV)} Max. Average Forward Current (Per Leg) * See Fig. 5 (Per Device)	2	A	50% duty cycle @ T _C = 129°C, rectangular wave form
	4		
I _{FSM} Max. Peak One Cycle Non-Repetitive Surge Current (Per Leg) * See Fig. 7	380	A	5μs Sine or 3μs Rect. pulse
	22		10ms Sine or 6ms Rect. pulse
E _{AS} Non-Repetitive Avalanche Energy (Per Leg)	1	mJ	T _J = 25°C, I _{AS} = 1 Amps, L = 2 mH
I _{AR} Repetitive Avalanche Current (Per Leg)	1	A	Current decaying linearly to zero in 1 μsec Frequency limited by T _J max. V _A = 1.5 x V _R typical

Electrical Specifications

Parameters	Values	Units	Conditions
V _{FM} Max. Forward Voltage Drop (Per Leg) * See Fig. 1 (1)	0.79	V	@ 1A
	0.89	V	@ 2A
	0.67	V	@ 1A
	0.76	V	@ 2A
I _{RM} Max. Reverse Leakage Current (Per Leg) * See Fig. 2 (1)	0.1	mA	T _J = 25°C
	10	mA	T _J = 125°C
C _T Typ. Junction Capacitance (Per Leg)	45	pF	V _R = 5V _{DC} (test signal range 100Khz to 1Mhz) 25°C
L _S Typical Series Inductance (Per Leg)	6	nH	Measured lead to lead 5mm from package body
dv/dt Max. Voltage Rate of Change	10000	V/μs	(Rated V _R)

(1) Pulse Width < 300μs, Duty Cycle <2%

Thermal-Mechanical Specifications

Parameters	Values	Units	Conditions
T _J Max. Junction Temperature Range (*)	-55 to 175	°C	
T _{stg} Max. Storage Temperature Range	-55 to 175	°C	
R _{thJA} Max. Thermal Resistance Junction to Ambient	65	°C/W	DC operation
R _{thJL} Max. Thermal Resistance Junction to Lead	25	°C/W	
wt Approximate Weight	0.13 (.0045)	g (oz.)	
Case Style	SOT-223		
Device Marking	2CJQJ		

(*) $\frac{dP_{tot}}{dT_J} < \frac{1}{R_{th(j-a)}}$ thermal runaway condition for a diode on its own heatsink

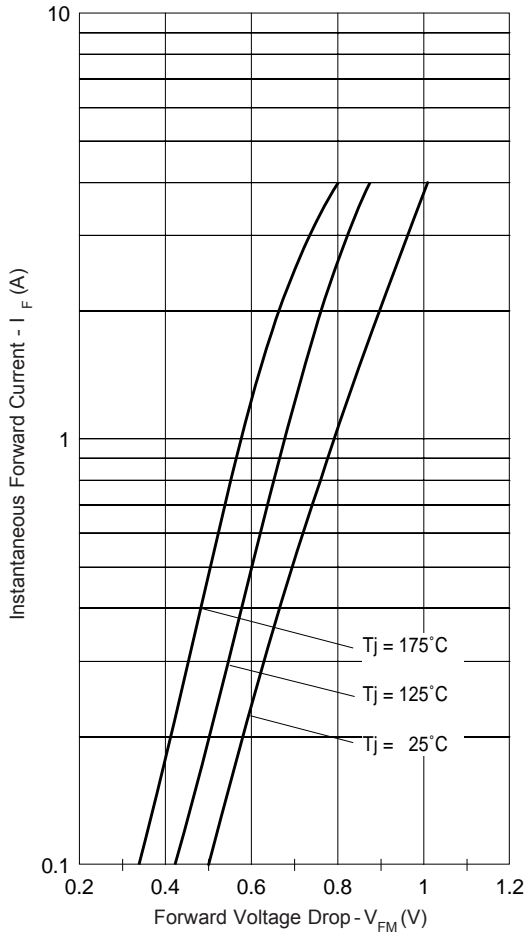

Fig. 1 - Maximum Forward Voltage Drop Characteristics

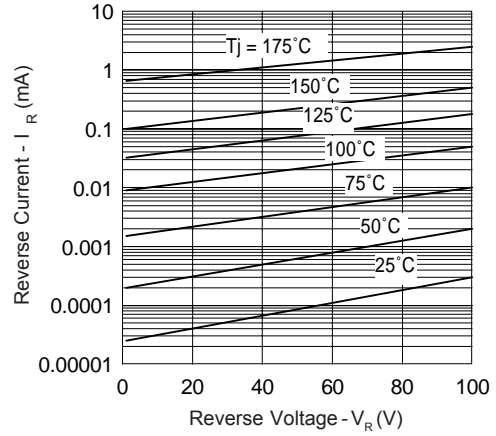

Fig. 2 - Typical Values of Reverse Current Vs. Reverse Voltage

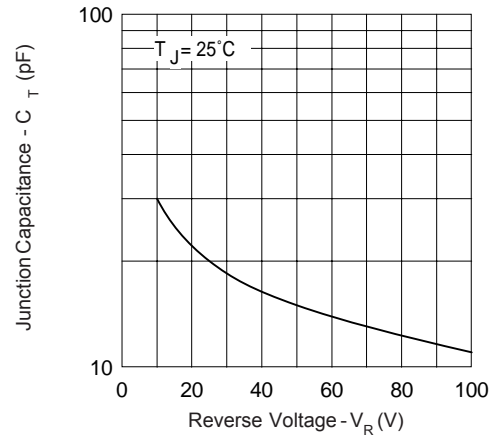

Fig. 3 - Typical Junction Capacitance Vs. Reverse Voltage

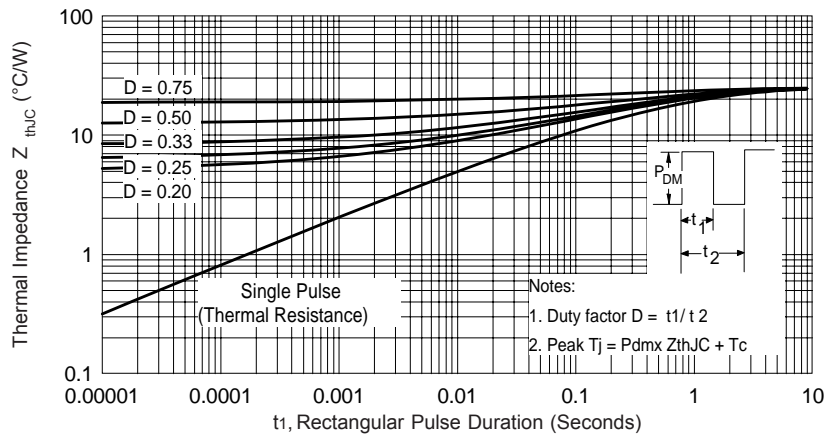

Fig. 4 - Max. Thermal Impedance Z_{thJC} Characteristics

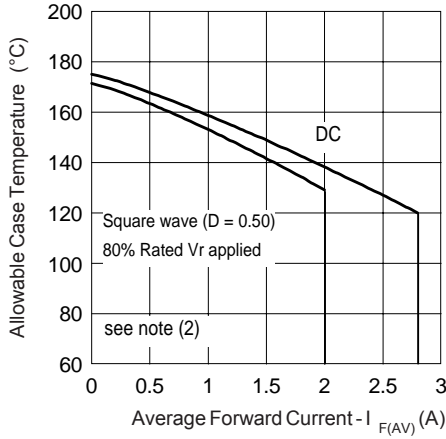

Fig. 5 - Max. Allowable Case Temperature Vs. Average Forward Current

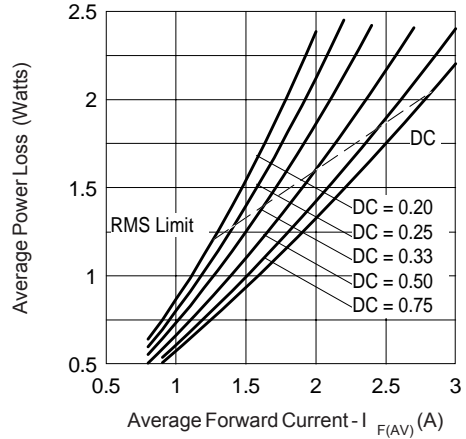

Fig. 6 - Forward Power Loss Characteristics

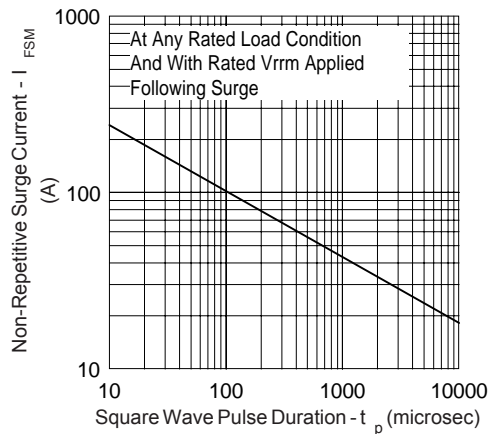

Fig. 7 - Max. Non-Repetitive Surge Current (Per Leg)

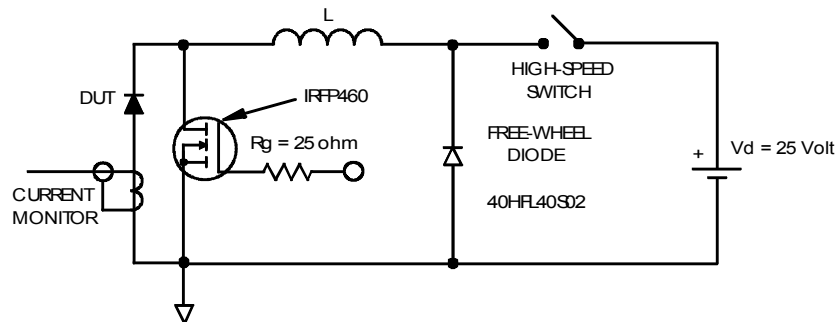

Fig. 8 - Unclamped Inductive Test Circuit

(2) Formula used: $T_C = T_J - (P_d + P_{d_{REV}}) \times R_{thJC}$;

P_d = Forward Power Loss = $I_{F(AV)} \times V_{FM} @ (I_{F(AV)} / D)$ (see Fig. 6);

$P_{d_{REV}}$ = Inverse Power Loss = $V_{R1} \times I_R (1 - D)$; $I_R @ V_{R1} = 80\% \text{ rated } V_R$

Outline Table

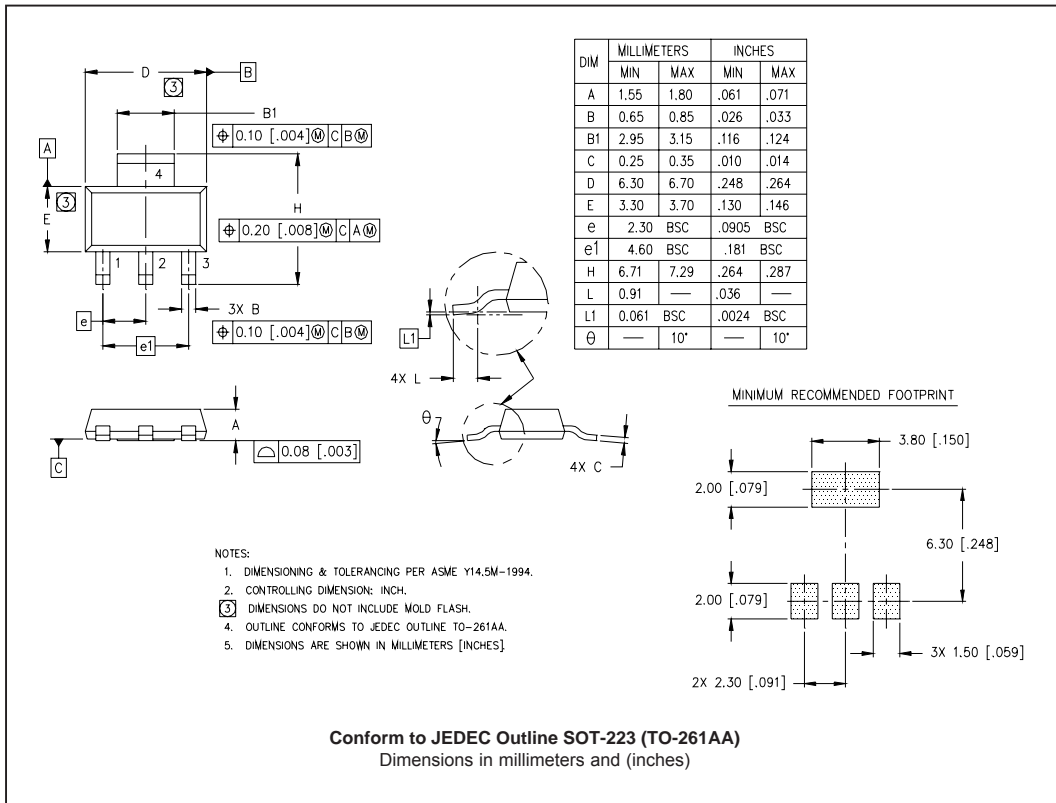

Marking Information

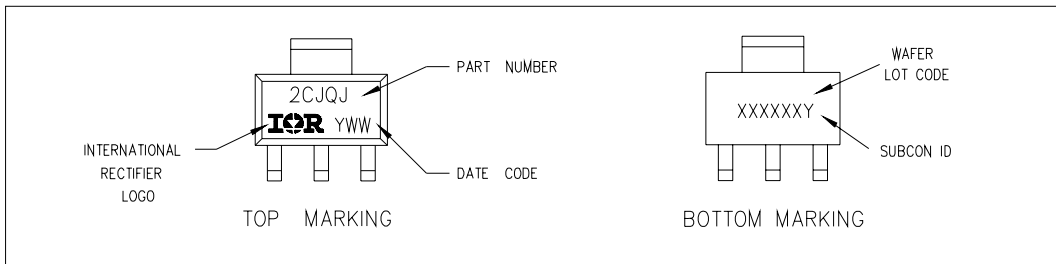

Tape and Reel Information

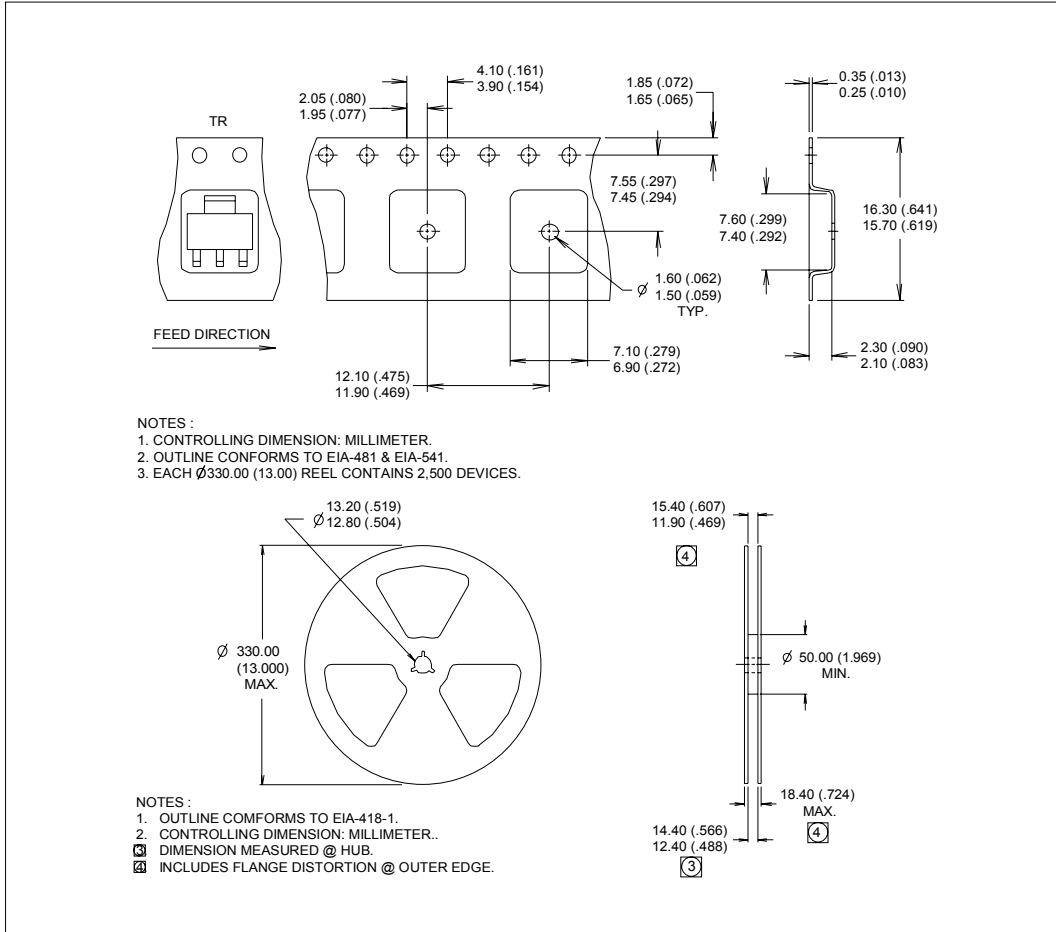

Ordering Information Table

Device Code						
2	0	C	J	Q	100	-
①	②	③	④	⑤	⑥	⑦
1	- Current Rating (2 = 2A)					
2	- Schottky Rectifier Series					
3	- Circuit Configuration C = Common Cathode					
4	- Package J = SOT-223					
5	- Schottky "Q" Series					
6	- Voltage Rating (100 = 100V)					
7	- • none = Standard Production • PbF = Lead-Free					

Data and specifications subject to change without notice.
 This product has been designed and qualified for Industrial Level.
 Qualification Standards can be found on IR's Web site.