

Section

III

Features	H-2
Selection Guide	H-3
Function Blocks	H-4
Specifications	H-5
Connection Diagrams	H-10
Dimensions	H-12
General Information	H-13
Programming	
• WindLGC	H-14

IDEC SmartRelay

for more information on this product family visit
www.idec.com/smartrelay

Additional Web Resources

- New and updated product information
- Downloadable software demos & upgrades
- Part configuration tool & cross reference
- Online stock check & ordering
- IDEC field sales & distributor search
- Online literature request
- Downloadable manuals & CAD drawings
- Manufacturer's suggested retail price list
- Product training schedule & locations
- Advertising & trade show schedules
- Press releases & FAQs

www.idec.com/smartrelay

IDEC SmartRelay

IDEC SmartRelay –the smart and expandable solution



Get smart with the fully programmable IDEC SmartRelay, a compact, expandable CPU that can replace multiple timers, relays and counters. Each CPU houses a real-time clock and calendar, and supports optional expansion I/O modules to enhance your control and monitoring applications. Program and edit using either the "smart" on-board selection buttons and display interface, or our even "smarter" software, WindLGC. The IDEC SmartRelay is the ideal solution for managing automatic lighting, access control, watering systems, pump control, or ventilation systems in factory or home automation.

Highlights of the FL1C series

- 32-bit processor
- 130 connectable blocks
- 4 new function blocks
- 4 x12 backlight display
- Timer and counter frequency up to 2KHz
- Online monitor
- Ladder programming
- Invert of inputs saves NOT function blocks

Digital/Analog Inputs

(6 Digital plus 2 Digital or Analog)
Multiple inputs provide direct communication with pushbuttons, sensors, switches, etc. (2kHz max. on I5 and I6). (Common use I/O for digital and analog: I7 and I8 on FL1C-H12RCE, FL1C-B12RCE, FL1C-H12SND.) Expandable up to 24 digital inputs.

LCD Display Panel

Display up to 48 characters as a text message. Monitor any of the 8 basic or 26 special function blocks, or confirm the status of the program for troubleshooting.

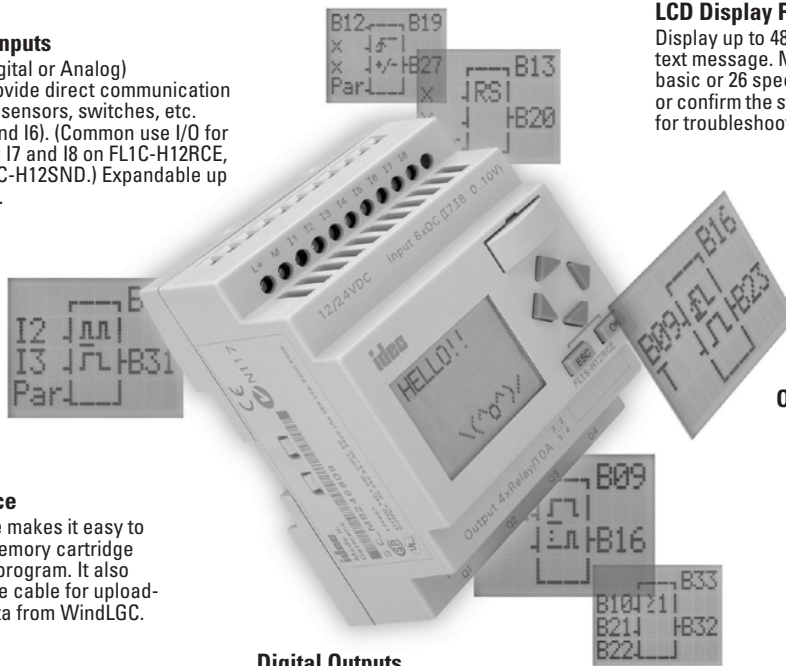

Multifunction Interface

A multifunction interface makes it easy to insert and remove the memory cartridge that controls the circuit program. It also supports the PC interface cable for uploading and downloading data from WindLGC.

Operational Control Buttons

Easy programming interface uses only six buttons. No tools necessary. Cursor keys can also be configured as inputs.

Other Key Features

- Password protection
- Daylight savings time
- UL/c-UL listed, IEC61131/VDE0631, EMC Compliant, C-tick listed
- FM approved for Class 1, Div 2 Class 1, Zone 2 hazardous locations.

Digital Outputs

Use the outputs to control lights, small-sized motors and solenoid valves up to 10A. Expandable up to 16 digital outputs.

IDEC SmartRelay

Other Characteristics

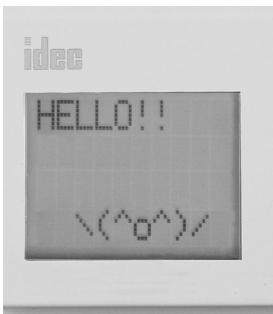

Text Display

It can display messages with background lighting up to 48 characters long from a selection of 97 character types.



Operational Buttons

Use the selection buttons for easy confirmation or modification of the circuit being displayed. The cursor keys can be configured as inputs.



Memory Cartridge

FL1C-PM3 is a memory cartridge with know-how protection. Not only is it possible to save your program, but also to protect it from unintended modification, copying or deletion.

Not required for operation.



Expansion Modules

Optional expansion I/O modules allow you to add digital input, output and LONWORKS®/AS-Interface communication modules as well as analog inputs to your system. Just snap-on and go – no special software or cables required.

Part Numbers

Base Module Part Number

Part Number	Rated Voltage	Input Signal	Input Type	Output Signal	With Display	With Clock	Input/Output
FL1C-H12RCE	12/24V DC	DC	PNP	Relay Output	Yes	Yes	8/4
FL1C-B12RCE				—			
FL1C-H12SND	24V DC	17 and 18 are used for digital/analog	PNP	Transistor Source Output	Yes	—	
FL1C-H12RCA	24V AC/DC			AC/DC	PNP/NPN	Relay Output	
FL1C-B12RCA		—	Yes				
FL1C-H12RCC	100-240V AC/DC	AC/DC		PNP	Relay Output	Yes	
FL1C-B12RCC			—				

Expansion Module Part Number

Part No.	Module	Power Voltage	Input	Output	Total I/O
FL1B-M08B2R2	Combination I/O Module	12/24V DC	DC input	Relay output	8 (4 in/4 out)
FL1B-M08B1S2		24V DC	DC input	Transistor output	8 (4 in/4 out)
FL1B-M08C2R2		100-240V AC/DC	AC/DC input	Relay output	8 (4 in/4 out)
FL1B-M08D2R2		24V AC/DC	AC/DC input	Relay output	8 (4 in/4 out)
FL1B-J2B2	Analog Input Module	12/24V DC	Analog input	—	2 (2 in/0 out)
FL1B-CL1C12	LONWORKS® Communication Module*	24V AC/DC	—	—	—
FL1B-CAS2	AS-Interface Communication Module*	30V DC	—	—	—



* For more information see Section M, Communications & Networking.

Starter Kit Part Number

Part Number	Description
SMARTSTART-BAC-C	FL1C-B12RCC, WindLGC software, and programming cable
SMARTSTART-BDC-C	FL1C-B12RCE, WindLGC software, programming cable, and simulator switch
SMARTSTART-HAC-C	FL1C-H12RCC, WindLGC software, and programming cable
SMARTSTART-HDC-C	FL1C-H12RCE, WindLGC software, programming cable, and simulator switch

Accessories

Part Number	Description	Note
FL1C-PM3	Memory Cartridge	Memory cartridge with know-how protection
FL9Y-LP1CDW	Programming Software: WindLGC Ver. 4	CD w/Online Manual
FL1A-PC1	PC Interface Cable	Connection of SmartRelay to PC
BAA1000 BNDN1000	35MM DIN Rail	Aluminum, 1m/3.28ft
BNL6	Mounting Clips	
MT-101	Memory Cartridge Removal Tool	
FL1B-PSP1	Direct Mounting Slides	
FL1B-Y1371-SW8	8pt simulator switch	used with 12, 24V DC base module only
FL9Y-B827	FL1C user's manual	
FC4A-USB	USB/RS232 converter	



Function Blocks

General Function Blocks

- AND**

 Series connection of normally open contacts
- AND (Edge)**

 Edge detection with edge evaluation (pos. edge)
- NAND**

 Parallel connection of normally closed contacts
- NAND (Edge)**

 Edge detection with edge evaluation (pos. edge)
- OR**

 Parallel connection of normally open contacts
- NOR**

 Series connection of normally closed contacts
- XOR**

 Double changeover contact
- NOT**

 Connection of closed contact

Special Function Blocks

- On-delay**
- Off-delay**
- On-/Off-delay**
- Retentive on-delay**
- Latching relay**
- Current impulse relay**
- Interval time-delay relay/ Pulse output**
- Edge-triggered interval time-delay relay**
- Seven-day time switch**
- Twelve-month time switch**
- Up/down counter**
- Analog differential trigger**
- Analog value monitoring**

- Operating hours counter**
- Asynchronous pulse generator**
- Random generator**
- Frequency trigger**
- Analog trigger**
- Analog comparator**
- Stairwell light switch**
- Dual-function switch**
- Message texts**
- Softkey**
- Analog amplifier**
- Shift register**

IDEC SmartRelay

Specifications

Item		Specifications	Compliant Standards	
General Specifications	Dimensions (W x H x D)	72 x 90 x 55 mm	—	
	Weight	Approx. 190g	—	
	Operating temperature	Horizontal	0 to +55°C	Cold: IEC60068-2-1 Hot: IEC60068-2-2
		Vertical	0 to +55°C	
	Storage temperature	-40 to +70°C	—	
	Relative humidity	10 to 85%	IEC60068-2-30	
	Pressure	795 to 1080 hPa	—	
	Corrosion immunity	Free from corrosive gases	—	
	Degree of protection	IP20	—	
	Vibration resistance	5 to 9Hz (amplitude: 3.2mm) 9 to 150Hz (acceleration: 10m/s ²)	IEC60068-2-6	
	Shock resistance	150 m/s ²	IEC60068-2-27	
	Dropping	50 mm (Drop height)	IEC60068-2-31	
	Free fall (packaged)	1 m	IEC60068-2-32	
	Emission	Class B Group 1	EN55011	
	EMC	Emitted interference	—	EN50081-2, EN50082-2
Electrostatic discharge		8kV Air Discharge 6kV Contact Discharge	IEC61000-4-2	
Electromagnetic fields		10V/m	IEC61000-4-3	
Burst pulses		2KV (Supply and Signal Lines)	IEC61000-4-4	
Energy carriers single pulse (surge)		0.5kV(Power Lines): Symmetrical 1kV (Power Lines): Asymmetrical	IEC61000-4-5	
Communication cable	2 x 1.5 mm ² , 1 x 0.5 to 2.5 mm ²	—		

Base Module Part Number	FL1C-H12RCE	FL1C-H12SND	FL1C-H12RCA	FL1C-H12RCC		
	FL1C-B12RCE	—	FL1C-B12RCA	FL1C-B12RCC		
Base Module Operating Specifications	Power Supply	Rated voltage	12/24V DC	24V DC	24V AC/DC	100-240V AC/DC
		Allowable Voltage Range	10.8-28.8V DC	20.4-28.8V DC	20.4V-26.4V AC 20.4V-28.8V DC	85-265 AC 100-253 V DC
		Rated Frequency	—	—	47-63Hz	50/60Hz (47-63Hz)
		Input Current	30-140 mA (12V DC) 20-75 mA (24V DC)	30-55 mA (24V DC)	40-110 mA (24V AC) 20-75 mA (24V DC)	10-40 mA (100V AC) 10-25 mA (240V AC) 5-25mA (100V DC) 5-15mA (240V DC)
		Allowable Momentary Power Interruption	2 ms (12V DC) 5 ms (24V DC)	—	5 ms	10 ms (100V AC) 20 ms (240V AC)
		Power Consumption	0.3-1.7W (12V DC) 0.4-1.8W (24V DC)	0.7-1.3W (24V DC)	0.9-2.7W (24V AC) 0.4 to1.8W (24V DC)	1.1-4.6W (100V AC) 2.4-6.0W (240V AC) 0.5-2.9W (100V DC) 1.2-3.6W (240V DC)
		Reverse Polarity Protection	Yes	Yes	—	—
Clock	Backup Duration	80h at 25°C	—	80h at 25°C	80h at 25°C	
	Clock Accuracy	±2s / day maximum	—	±2s / day maximum	±2s / day maximum	

Specifications con't

Base Module Part Number		FL1C-H12RCE	FL1C-H12SND	FL1C-H12RCA	FL1C-H12RCC	
		FL1C-B12RCE	—	FL1C-B12RCA	FL1C-B12RCC	
Input	Input Signal	DC	DC	AC/DC	AC/DC	
	Input Points	8 (I1-I8)	8 (I1-I8)	8 (I1 - I8)	8 (I1-I8)	
	Analog Input Points	2 (I7, I8)*	2 (I7, I8)*	—	—	
	Fast Inputs	2 (I5, I6) Max 2KHz**	2 (I5, I6) Max 2 KHz**	—	—	
	Analog Input Voltage Range	0 to 10V DC (maximum rated voltage: 28.8V DC)	0 to 10V DC (maximum rated voltage: 28.8V DC)	—	—	
	Rated Input Voltage	12/24V DC	24V DC	24V AC/DC	100-240V AC/DC	
	Allowable Voltage Range	10.8-28.8V DC	20.4-28.8V DC	0-26.4V AC 0-28.8V DC	85-253V AC, 100-253 VDC	
	Isolation	Not Isolated	Not Isolated	Not Isolated	Not Isolated	
	Operating Range	Turn OFF Voltage	< 5V DC	< 5V DC	< 5V AC/DC	< 40V AC, < 30 VDC
		Turn ON Voltage	> 8V DC	> 8V DC	> 12V AC/DC	> 79V AC, > 79VDC
		Turn OFF Current	< 1.0 mA (I1-I6) < 0.05 mA (I7-I8)	< 1.0 mA (I1-I6) < 0.05 mA (I7-I8)	< 1.0 mA	< 0.03 mA
		Turn ON Current	> 1.5 mA (I1-I6) > 0.1 mA (I7-I8)	> 1.5 mA (I1-I6) > 0.1 mA (I7-I8)	> 2.5 mA	> 0.08 mA
	Turn ON Time	1.5ms (Typ.) (I1-14) <1.0ms (I5, I6) 300ms Typ. (I7, I8)	1.5ms (Typ.) (I1-14) <1.0ms (I5, I6) 300ms Typ. (I7, I8)	1.5 ms (Typ.)	50 ms (Typ.)	
	Turn OFF Time	1.5ms (Typ.)	1.5 ms (Typ.)	15 ms (Typ.)	50 ms (Typ.)	
Wire Length	100m	100m	100m	100m		
Output	Output Signal	Relay Output	Transistor Source Output	Relay Output	Relay Output	
	Output Type	4NO contacts	4 points	4NO contacts	4NO contacts	
	Isolation	Isolated	Not Isolated	Isolated	Isolated	
	Dielectric Strength (between power/ input terminal and output terminals)	2,500V AC/1 minute 500V DC/1 minute	—	2,500V AC/1 minute 500V DC/1 minute	2,500V AC/1 minute 500V DC/1 minute	
	Output Voltage	—	Ext. power supply 20.4-28.8V DC	—	—	
	Maximum Load Current	Resistive Load 10A at 12/24V AC/DC 10A at 100/120V AC 10A at 230/240V AC Inductive Load 2A at 12/24V AC/DC 3A at 100/120V AC 3A at 230/240V	0.3A	Resistive Load 10A at 12/24V AC/DC 10A at 100/120V AC/DC 10A at 230/240V AC/DC Inductive Load 2A at 12/24V AC/DC 3A at 100/120V AC/DC 3A at 230/240V AC/DC	Resistive Load 10A at 12/24V AC/DC 10A at 100/120V AC 10A at 230/240V AC Inductive Load 2A at 12/24V AC/DC 3A at 100/120V AC 3A at 230/240V AC	
	Short Circuit Protection	External fuse 16A maximum	Internal current limiting circuit: 1A	External fuse 16A maximum	External fuse 16A maximum	
	Minimum Switching Load	10 mA, 12V DC	—	10 mA, 12V DC	10 mA, 12V DC	
	Initial Contact Resistance	100 mΩ maximum (at 1A, 24V DC)	—	100 mΩ maximum (at 1A, 24V DC)	100 mΩ maximum (at 1A, 24V DC)	
	Mechanical Life	10,000,000 operations minimum (no load, 10Hz)	—	10,000,000 operations min (no load, 10Hz)	10,000,000 operations minimum (no load, 10Hz)	
	Electrical Life	100,000 operations minimum (rated load 10A, 1,800 operations/hour)	—	100,000 operations min (rated load 10A, 1,800 operations/hour)	100,000 operations minimum (rated load 10A, 1,800 operations/hour)	
	Switching Rate	Mechanical Load	10 Hz	—	10 Hz	10 Hz
		Electrical Load	—	10 Hz	—	—
Resistive Load/Lamp Load		2 Hz	10 Hz	2 Hz	2 Hz	
Inductive Load		0.5 Hz	0.5 Hz	0.5 Hz	0.5 Hz	

* Input terminals 17 and 18 are used for digital and analog inputs.

** When selecting frequency trigger function.



Specifications con't

Expansion I/O Part Number		Combination I/O Module				Analog Input Module	
		FL1B-M08B2R2	FL1B-M08B1S2	FL1B-M08D2R2	FL1B-M08C2R2	FL1B-J2B2	
Power Supply	Rated voltage	12/24V DC	24V DC	24V AC/DC	100-240V AC/DC	12/24V DC	
	Allowable Voltage Range	10.8-28.8V DC	20.4-28.8V DC	20.4V-26.4V AC 20.4V-28.8V DC	85-265V AC 100-253V DC	10.8-15.6V DC 20.4-28.8V DC	
	Rated Frequency	—	—	47-63Hz	50/60Hz (47-63Hz)	—	
	Input Current	30-140 mA (12V DC) 22-75 mA (24V DC)	30-45 mA (24V DC)	40-110 mA (24V AC) 20-75 mA (24V DC)	10-30 mA (100V AC) 10-20 mA (240V AC) 5-15mA (100V DC) 5-10mA (240V DC)	25-50mA	
	Allowable Momentary Power Interruption	2 ms (12V DC) 5 ms (24V DC)	—	5 ms	10 ms (100V AC) 20 ms (240V AC)	5 ms	
	Power Consumption	0.3-1.7W (12V DC) 0.4-1.8W (24V DC)	0.8-1.1W (24V DC)	0.9-2.7W (24V AC) 0.4 to 1.8W (24V DC)	1.1-3.5W (100V AC) 2.4-4.8W (240V AC) 0.5-1.8W (100V DC) 1.2-2.4W (240V DC)	0.3-0.6W (12V DC) 0.6-1.2W (24V DC)	
	Reverse Polarity Protection	Yes	Yes	—	—	Yes	
Input	Input Signal	DC	DC	AC/DC	AC/DC	Analog	
	Input Points	4	4	4	4	—	
	Analog Input Points	—	—	—	—	2	
	Input Impedance	—	—	—	—	76 k Ω (0-10V DC) 155-250 Ω (0-20mA DC)	
	Analog Input Range	—	—	—	—	0-10V DC (28.8V max) 0-20mA (40mA max)	
	Digital Resolution	—	—	—	—	10 bits (0-1000)	
	Rated Input Voltage	12/24V DC	24V DC	24V AC/DC	100-240V AC/DC	—	
	Allowable Voltage Range	10.8-15.6V DC 20.4-28.8V DC	20.4-28.8V DC	0-26.4V AC 0-28.8V DC	85-253V AC 100-253V DC	—	
	Isolation	Not Isolated	Not Isolated	Not Isolated	Isolated	Not Isolated	
	Operating Range	Turn OFF Voltage	< 5V DC	< 5V DC	< 5V AC/DC	< 40V AC < 30V DC	—
		Turn ON Voltage	> 8V DC	> 8V DC	> 12V AC/DC	> 79V AC > 79V DC	—
		Turn OFF Current	< 1.0 mA	< 1.0 mA	< 1.0 mA	< 0.3 mA	—
		Turn ON Current	> 1.5 mA	> 1.5 mA	> 2.5 mA	> 0.08 mA	—
	Turn ON Time	1.5ms	1.5 ms	1.5 ms (Typ.)	50 ms (Typ.)	—	
	Turn OFF Time	1.5ms	1.5 ms	15 ms (Typ.)	50 ms (Typ.)	—	
	Analog Value Conversion Interval	—	—	—	—	50ms	
	Wire Length	100m	100m	100m	100m	10m (twisted-pair shielded cable)	
Output	Output Signal	Relay Output	Transistor Source Output	Relay Output	Relay Output	—	
	Output Type	4NO contacts	4 points	4NO contacts	4NO contacts	—	
	Isolation	Isolated	Not Isolated	Isolated	Isolated	—	
	Dielectric Strength (between power/ input terminal and output terminals)	2,500V AC/1 minute 500V DC/1 minute	2,500V AC/1 minute 500V DC/1 minute	2,500V AC/1 minute 500V DC/1 minute	2,500V AC/1 minute 500V DC/1 minute	—	
	Output Voltage	—	Ext. power supply 20.4-28.8V DC	—	—	—	
	Maximum Load Current	Resistive Load 10A at 12/24V AC/DC 10A at 100/120V AC 10A at 230/240V AC Inductive Load 2A at 12/24V AC/DC 3A at 100/120V AC 3A at 230/240V	0.3A	Resistive Load 5A at 12/24V AC/DC 5A at 100/120V AC/DC 5A at 230/240V AC/DC Inductive Load 2A at 12/24V AC/DC 3A at 100/120V AC/DC 3A at 230/240V AC/DC	Resistive Load 10A at 12/24V AC/DC 10A at 100/120V AC 10A at 230/240V AC Inductive Load 2A at 12/24V AC/DC 3A at 100/120V AC 3A at 230/240V AC	—	
	Short Circuit Protection	External fuse required 16A max	Internal current limiting resistor: 1A	External fuse 16A maximum	External fuse 16A maximum	—	
	Minimum Switching Load	10 mA, 12V DC	—	10 mA, 12V DC	10 mA, 12V DC	—	
	Initial Contact Resistance	100 m Ω maximum (at 1A, 24V DC)	—	100 m Ω maximum (at 1A, 24V DC)	100 m Ω maximum (at 1A, 24V DC)	—	
	Mechanical Life	10,000,000 operations (no load)	—	10,000,000 operations min (no load, 10Hz)	10,000,000 operations (no load)	—	
	Electrical Life	100,000 operations (rated resistive load 1,800 operations/hr)	—	100,000 operations minimum (rated load 1,800 operations/hour)	100,000 operations (rated resistive load 1,800 operations/hr)	—	
Switching Rate	Mechanical Load	10Hz	—	10 Hz	10Hz	—	
	Electrical Load	—	10Hz	—	—	—	
	Resistive Load/Lamp Load	2Hz	10Hz	2 Hz	2Hz	—	
	Inductive Load	0.5Hz	0.5Hz	0.5 Hz	0.5Hz	—	

Specifications con't

Operating Specifications - LonWorks Communication Module

Operating Temperature		0 to 55°C (no freezing)
Operating Humidity		10 to 85% RH (no condensation)
Storage Temperature		-40 to +70°C (no freezing)
Storage Humidity		10 to 85% RH (no condensation)
Rated Power Voltage		24V AC/DC
Allowable Voltage Range		20.4 to 26.4V AC, 20.4 to 28.8V DC
Current Draw		33 mA max.
Dielectric Strength		500V DC, 1 minute (between power terminal and dead parts)
Insulation Resistance		10 MΩ minimum (500V DC megger between power terminal and dead parts)
EMC	Electrostatic Discharge	8 kV air discharge 6 kV contact discharge
	Burst Pulses	2 kV (power terminal)
Vibration Resistance		5 to 9 Hz, amplitude 3.5 mm 9 to 150 Hz, 9.8 m/s ²
Shock Resistance		150 m/s ²
Dimensions		35.5W × 90H × 58D mm
Mounting Style		DIN rail or panel surface
Degree of Protection		IP20
Terminal Style		Screw-cage clamp terminal
Weight		85g
Communication System		LON [®] system
Transceiver		FTT-10A
Topology		Bus topology, free topology
Transmission Rate		78 kbps
Neuron Chip		TMPN3120FE5M (Toshiba)
CPU Clock Frequency		20 MHz
Transmission Distance		Bus topology: 1400m (only FTT-10A transceiver, using Level 4 AWG22 cable) Free topology: 500m total, 400m between nodes (when using Level 4 AWG22 cable)

Network Variables	Input Network Variable	SNVT_obj_request: (Quantity 1)	Request object mode
		SNVT_switch: (Quantity 14)	Switch light, alarm, window contact, free inputs/outputs
		SNVT_occupancy: (Quantity 2)	Occupancy
		SNVT_temp_p: (Quantity 1)	Room temperature (°C)
		SNVT_lux: (Quantity 1)	Brightness - lighting level (lux)
		SNVT_lev_percent: (Quantity 6)	Position (%)
	Output Network Variable	SNVT_obj_status: (Quantity 1)	Output object status
		SNVT_switch: (Quantity 8)	Switch light, alarm, window contact, free inputs/outputs
		SNVT_occupancy: (Quantity 2)	Occupancy
	Configuration Property	SNVT_tod_event: (Quantity 2)	Scheduler program Just current state
SCPTmaxSendTime:		Send heartbeat (Q5 to Q16)	

Specifications con't

Operating Specifications - AS-Interface Communication Module	Operating Temperature	0 to 55°C	
	Storage Temperature	-40 to +70°C	
	Relative Humidity	10 to 85% (no condensation)	
	Rated As-interface Voltage	30 VDC (26.5VDC to 31.6VDC)	
	Reverse Polarity Protection	Yes	
	Current Draw	70 mA max.	
	EMC	Electrostatic Discharge	8 kV air discharge (IEC61000-4-2) 4 kV contact discharge
		Electromagnetic filed	Filed strength 10V/m (IEC61000-4-3)
		First Transient Burst Pulse	1kV (criteria A) (IEC61000-4-4) 1kV (criteria B)
		Radiated Emission	Class A (EN55011)
	Vibration Resistance	5 to 9 Hz, amplitude 3.5 mm 9 to 150 Hz, 9.8 m/s ²	
	Shock Resistance	147 m/s ² 11ms (X, Y, Z each direction 3 times)	
	Slave type	Standard slave	
	Profile	I/O code 7 I/D code F I/D2 code F	
	Degree of Protection	IP20	
Terminal Style	Screw terminal (tightening torque: max. 0.5Nm)		
Applicable wire	0.5 to 1.5mm ²		
Instruction	on a 35mm mounting rail according to DIN EN50022/wall mounting		
Dimensions	36W × 90H × 58D mm		
Weight	75g		

Logic Assignments

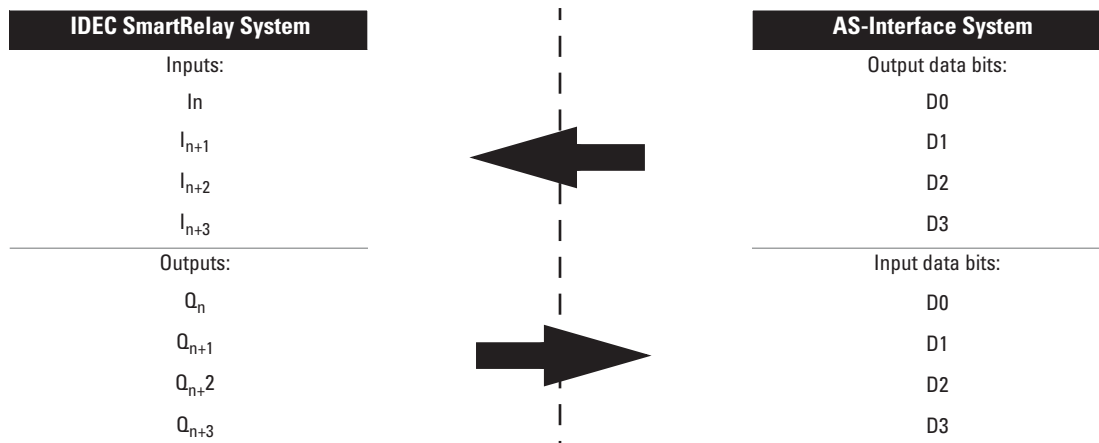

"n" depends on the plug-in position of the expansion module relative to the IDEC SmartRelay CPU. It indicates the number of the input or output in the IDEC SmartRelay program code.

Connection Diagrams

Inputs (CPU)

FL1C-H12RCE/-B12RCE/H12SND

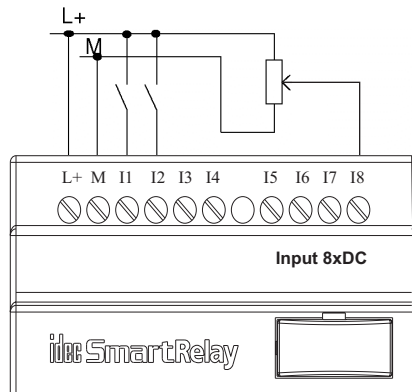

The inputs of these devices are non-isolated and therefore require the same reference potential (ground) as the power supply. With the FL1B-H12RCE/-B12RCE and FL1B-H12SND you can tap the analog signal between the supply voltage and ground

FL1C-H12RCC/-B12RCC

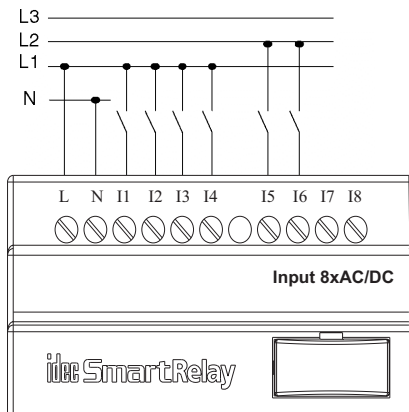

The inputs of these devices are arranged in 2 groups with 4 inputs each. Different phases are only possible between, but not within the blocks.



Current safety regulations (VDE 0110, ... and IEC 61131-2, ... as well as UL and CSA) do not permit the connection of different phases to one input group (I1-4 or I5-8) of an AC model or on the inputs of one digital module.

FL1C-H12RCA/-B12RCA

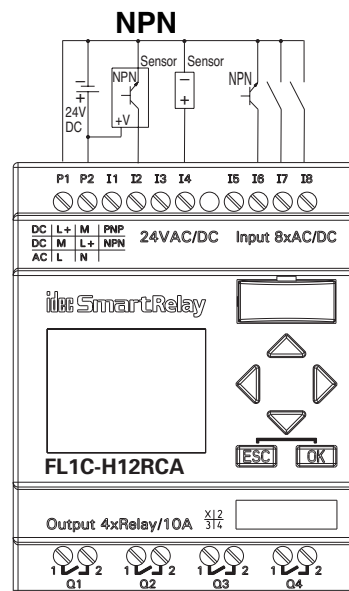
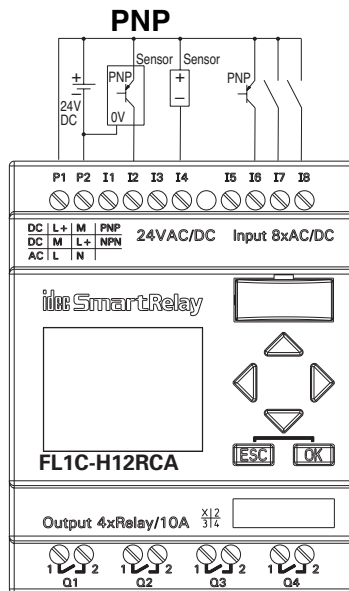

IDEC SmartRelay

Connection Diagrams con't

Outputs

Connecting the load to the FL1C-*12R:**

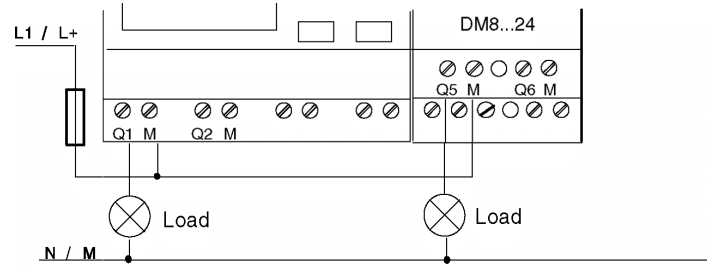

Protection with automatic circuit breaker (max. 16A) if desired

Connecting the load to a IDEC SmartRelay with transistor outputs (FL1C-H12SND):

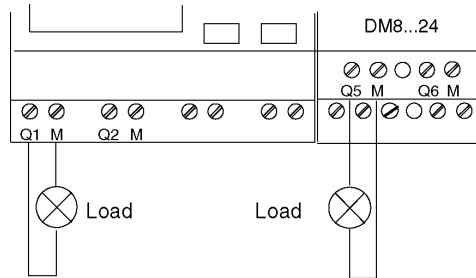

Load: 24 V DC, 0.3 A max.

Analog Input Expansion Module

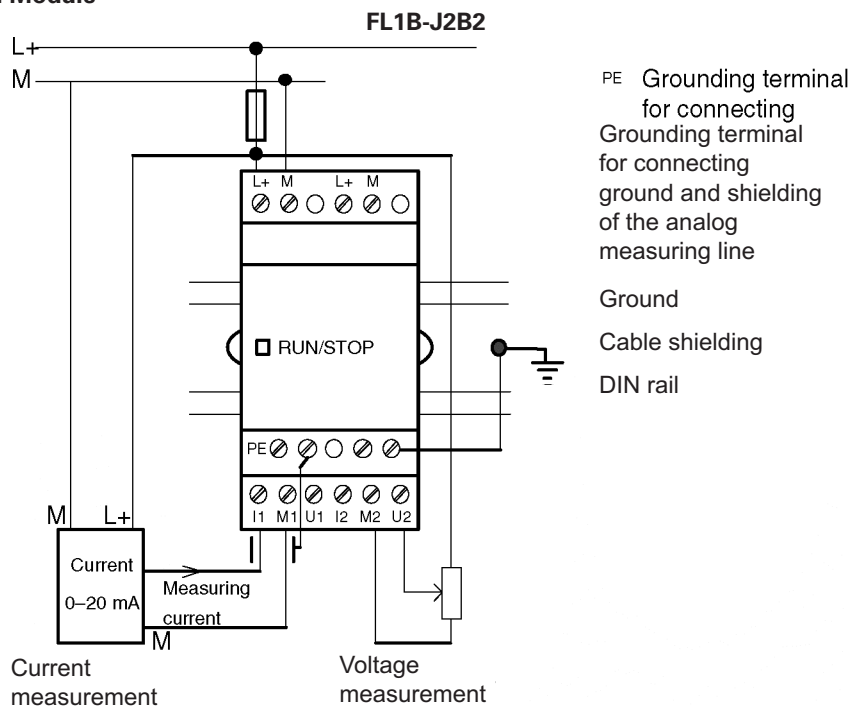

Dimensions

Base Module

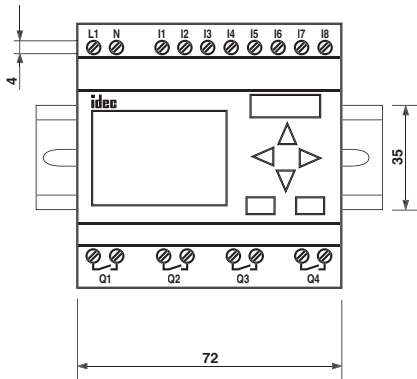

Expansion Module

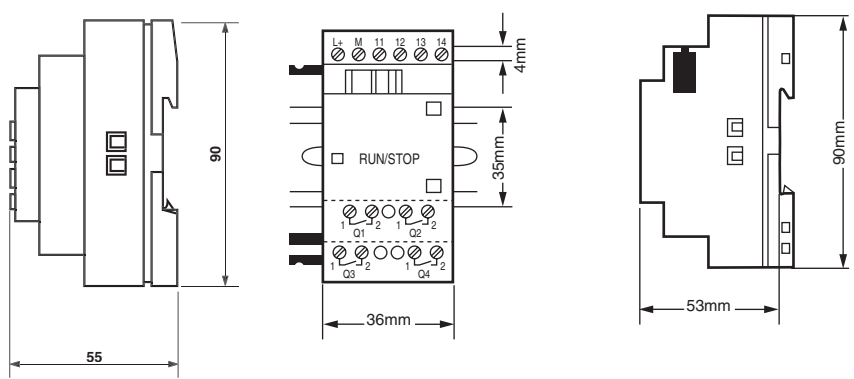

LONWORKS®/AS-Interface Communication Module

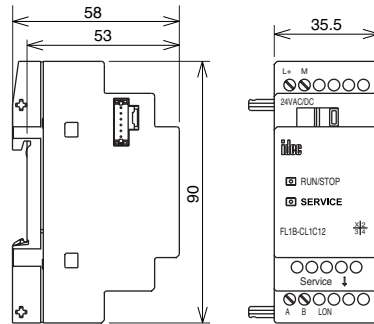

Mounting Hole Layout

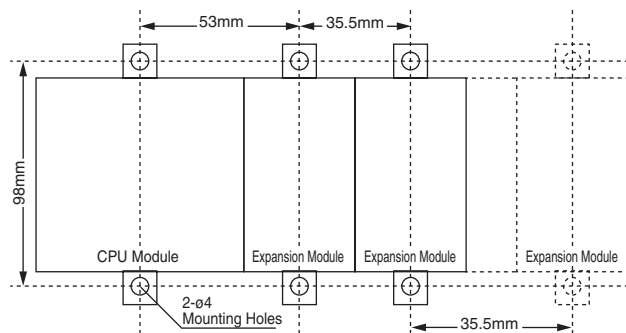

H
IDEC SmartRelay

General Information

Maximum Setup

- **Maximum Setup of IDEC SmartRelay With Analog Inputs FL1C-H12RCE/B12RCE/H12SND**
(CPU, 4 digital modules and 3 analog modules)

I1...I6, I7, I8 AI1, AI2	I9...I12	I13...I16	I17...I20	I21...I24	AI3, AI4	AI5, AI6	AI7, AI8
CPU	FL1B-M08B2R2	FL1B-M08B2R2	FL1B-M08B2R2	FL1B-M08B2R2	FL1B-J2B2	FL1B-J2B2	FL1B-J2B2
Q1...Q4	Q5...Q8	Q9...Q12	Q13...Q16				

- **Maximum Setup of IDEC SmartRelay Without Analog Inputs FL1C-H12RCA/B12RCA/H12RCC/B12RCC**
(CPU, 4 digital modules and 4 analog modules)

I1...I8	I9...I12	I13...I16	I17...I20	I21...I24	AI1, AI2	AI3, AI4	AI5, AI6	AI7, AI8
CPU	FL1B-M08	FL1B-M08	FL1B-M08	FL1B-M08	J2B2	J2B2	J2B2	J2B2
Q1...Q4	Q5...Q8	Q9...Q12	Q13...Q16					

- **High-speed/Optimal Communication Performance**

For optimal and high-speed communication performance between the IDEC SmartRelay and the various modules, we recommend you install the digital modules first, then the analog modules (see example above).

Setup With Different Voltage Classes

- **Rules**
Digital modules can only be connected to devices of the same voltage class.
- **Overview:** Connecting an expansion module to IDEC SmartRelay

CPU	Expansion Modules					
	M08B2R2	M08B1S2	M08D2R2	M08C2R2	J2B2	AS-i/LON
FL1C-H12RCE	X	X	X	–	X	X
FL1C-H12SND	X	X	X	–	X	X
FL1C-H12RCA	X	X	X	–	X	X
FL1C-H12RCC	–	–	–	X	X	X
FL1C-B12RCE	X	X	X	–	X	X
FL1C-B12RCA	X	X	X	–	X	X
FL1C-B12RCC	–	–	–	X	X	X

- **Overview:** Connecting an additional expansion module to an expansion module

Expansion Module	Additional Expansion Modules						
	M08B2R2	M08B1S2	M08D2R2	M08C2R2	J2B2	CAS2	CL1C12
FL1B-M08B2R2	X	X	X	–	X	X	X
FL1B-M08B1S2	X	X	X	–	X	X	X
FL1B-M08D2R2	X	X	X	–	X	X	X
FL1B-M08C2R2	–	–	–	X	X	X	X
FL1B-J2B2	X	X	X	–	X	X	X
FL1B-CAS2 AS-Interface	X	X	X	–	X	–	–
FL1B-CL1C12 LONWORKS	–	–	–	–	–	–	–

I/O Configuration with LONWORKS® Communication Module

Module Combination and Allocation Numbers

1. Maximum number of I/O points using LONWORKS® communication module

	FL1C-H12RCC								FL1B-CL1C12															
Digital Input:I	1	2	3	4	5	6	7	8	9	10	11	12	13	14	15	16	17	18	19	20	21	22	23	24
Analog Input:AI									1	2	3	4	5	6	7	8								
Digital Output:Q	1	2	3	4					5	6	7	8	9	10	11	12	13	14	15	16				

2. Using analog inputs on the base module

	FL1C-H12RCE								FL1B-CL1C12															
Digital Input:I	1	2	3	4	5	6	7	8	9	10	11	12	13	14	15	16	17	18	19	20	21	22	23	24
Analog Input:AI	1	2							3	4	5	6	7	8										
Digital Output:Q	1	2	3	4					5	6	7	8	9	10	11	12	13	14	15	16				

3. Using expansion I/O modules

	FL1C-H12RCE								FL1B-M08B2R2				FL1B-CL1C12											
Digital Input:I	1	2	3	4	5	6	7	8	9	10	11	12	13	14	15	16	17	18	19	20	21	22	23	24
Analog Input:AI	1	2											3	4	5	6	7	8						
Digital Output:Q	1	2	3	4					5	6	7	8	9	10	11	12	13	14	15	16				

FL1B-J2B2

■ Base module, ■ LONWORKS® communication module, ■ Combination I/O module, ■ Analog input module



1. The LONWORKS® communication module can be used with any base module and expansion I/O module.
2. The LONWORKS® communication module must be mounted at the right-most position of the row.
3. I/O numbers are automatically allocated starting with the base module.

WindLGC Programming Software

WindLGC is the exclusive programming software for the IDEC SmartRelay using Windows®. Edit, save, and print out your programs.

WindLGC Ver. 4 Features:

- Ladder programming
- Online Monitor
- Program Comparison
- Time Simulation
- Simplified connection of the functions
- Programs can be saved in PDF or JPG format

Just click the function blocks you need and link function blocks for easy wiring. Devise complicated circuits using the convenient functions of WindLGC.

To configure IDEC SmartRelay FL1C series, you must upgrade to WindLGC version 4.0.

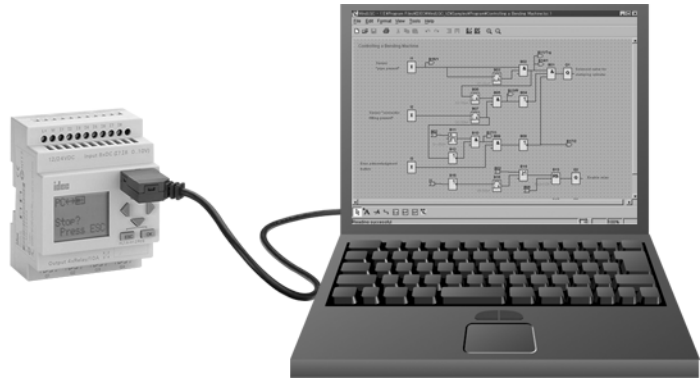

WindLGC system requirements:

- OS: Windows95/98/ME/NT/2000/XP
 - CPU recommendation: Pentium 266MHz or higher
 - Memory: 64MB or more
 - RAM recommendation: 128MB
 - Hard disk space: 90MB or more for installing WindLGC software.
 - Monitor Recommendation: Display more than 800 x 600 dots and 256 colors
- Free download service, if upgrading from WindLGC Version 3 to Version 4, available at www.idec.com/usa

Program Comparison

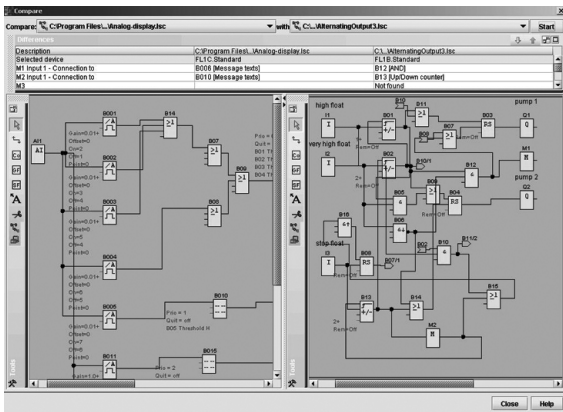

Simulation Mode/Online Monitor

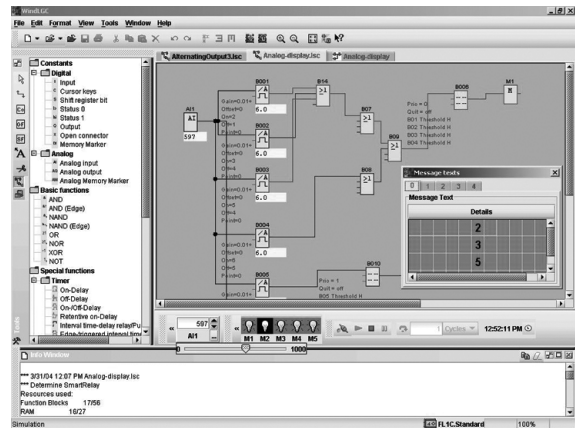

Ladder Programming

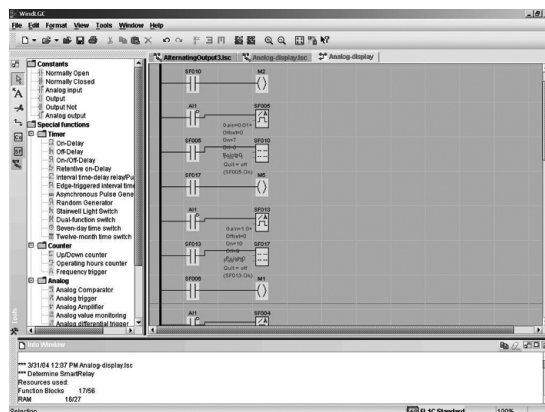

IDEC SmartRelay