

5A Low Dropout Linear Regulator

Features

- Low Dropout Voltage: 1.3V Typically at 5A
- Current Limiting and Thermal Protection
- Output Current: 5A
- Current Limit: 6.5A
- Operating Junction Temperature Range: 0 to 125°C
- Line Regulation: 0.015% (Typical)
- Load Regulation: 0.2% (Typical)
- Available in RoHS Compliant, Lead Free Packaging

TO-263-3

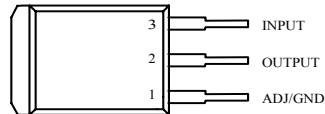

Applications

- High Efficiency Linear Regulators
- Battery Chargers
- Post Regulation for Switching Supply
- Microprocessor Supply
- Desktop PCs, RISC and Embedded Processors Supply

General Description

The SP1084 is a series of low dropout positive voltage regulators with a maximum dropout of 1.5V at 5A of load current.

The series features on-chip thermal limiting which provides protection against any combination of overload and ambient temperatures that would create excessive junction temperatures. It also includes a trimmed band-gap reference and a current limiting circuit.

The SP1084 is available in 1.5V, 1.8V, 2.5V, 2.85V, 3.3V and 5.0V versions. The fixed versions integrate the adjustment resistors. It is also available in an adjustable version which can set the output voltage with two external resistors.

The SP1084 series is available in standard packages of TO-263-3, TO-220 and TO-252.

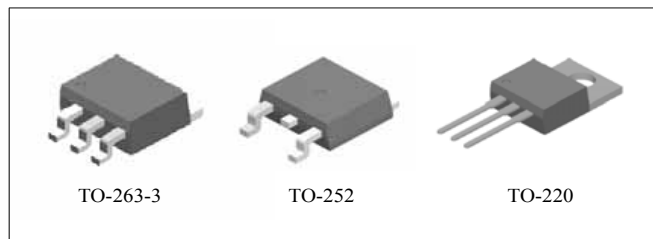
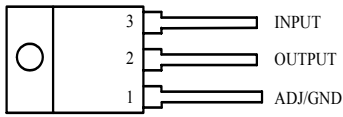

Figure 1. Package Types of SP1084

Pin Configuration

V Package
(TO-220)



V2 Package
(TO-252)

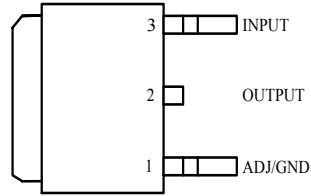

V1 Package
(TO-263-3)

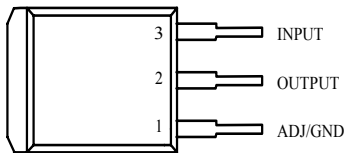

Figure 2. Pin Configuration of SP1084 (Top View)

Functional Block Diagram

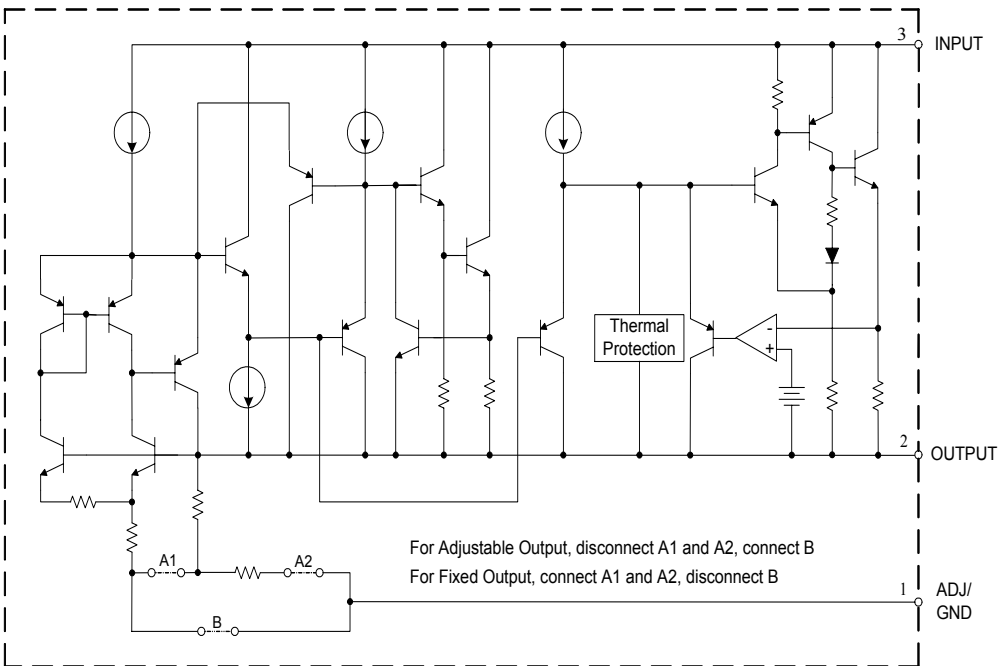

Figure 3. Functional Block Diagram of SP1084

Absolute Maximum Ratings (Note 1)

Parameter	Symbol	Min	Max	Unit
Operating Junction Temperature Range	T_J		150	$^{\circ}\text{C}$
Storage Temperature Range	T_S	-65	150	$^{\circ}\text{C}$
Lead Temperature (Soldering, 10 sec.)	T_{LEAD}		300	$^{\circ}\text{C}$
ESD (Human Body Model)	ESD		2000	V

Note 1: Stresses greater than those listed under "Absolute Maximum Ratings" may cause permanent damage to the device. These are stress ratings only, and functional operation of the device at these or any other conditions beyond those indicated under "Recommended Operating Conditions" is not implied. Exposure to "Absolute Maximum Ratings" for extended periods may affect device reliability.

Recommended Operating Conditions

Parameter	Symbol	Min	Max	Unit
Input Voltage	V_{IN}		12	V
Operating Junction Temperature Range	T_J	0	125	$^{\circ}\text{C}$

Electrical Characteristics

Typicals and limits appearing in normal type apply for $T_j = 25^\circ\text{C}$. Limits appearing in **Boldface** type apply over the entire operating junction temperature range.

Parameter	Symbol	Conditions	Min	Typ	Max	Unit
Reference Voltage	V_{REF}	SP1084-ADJ, $I_{\text{OUT}} = 10\text{mA}$, $V_{\text{IN}} - V_{\text{OUT}} = 3\text{V}$, $10\text{mA} \leq I_{\text{OUT}} \leq 5\text{A}$, $1.5\text{V} \leq V_{\text{IN}} - V_{\text{OUT}} \leq 5\text{V}$	1.238 1.225	1.250 1.250	1.262 1.270	V
Output Voltage	V_{OUT}	SP1084-1.5, $I_{\text{OUT}} = 0\text{mA}$, $V_{\text{IN}} = 4.5\text{V}$, $10\text{mA} \leq I_{\text{OUT}} \leq 5\text{A}$, $3.1\text{V} \leq V_{\text{IN}} \leq 6\text{V}$	1.485 1.47	1.5 1.5	1.515 1.53	V
		SP1084-1.8, $I_{\text{OUT}} = 0\text{mA}$, $V_{\text{IN}} = 4.8\text{V}$, $10\text{mA} \leq I_{\text{OUT}} \leq 5\text{A}$, $3.4\text{V} \leq V_{\text{IN}} \leq 6\text{V}$	1.782 1.764	1.8 1.8	1.818 1.836	V
		SP1084-2.5, $I_{\text{OUT}} = 0\text{mA}$, $V_{\text{IN}} = 5.5\text{V}$, $10\text{mA} \leq I_{\text{OUT}} \leq 5\text{A}$, $4.1\text{V} \leq V_{\text{IN}} \leq 7\text{V}$	2.475 2.45	2.5 2.5	2.525 2.55	V
		SP1084-2.85, $I_{\text{OUT}} = 0\text{mA}$, $V_{\text{IN}} = 6\text{V}$, $10\text{mA} \leq I_{\text{OUT}} \leq 5\text{A}$, $4.5\text{V} \leq V_{\text{IN}} \leq 8\text{V}$	2.822 2.793	2.85 2.85	2.879 2.907	V
		SP1084-3.3, $I_{\text{OUT}} = 0\text{mA}$, $V_{\text{IN}} = 6.3\text{V}$, $10\text{mA} \leq I_{\text{OUT}} \leq 5\text{A}$, $4.9\text{V} \leq V_{\text{IN}} \leq 8\text{V}$	3.267 3.234	3.3 3.3	3.333 3.366	V
		SP1084-5.0, $I_{\text{OUT}} = 0\text{mA}$, $V_{\text{IN}} = 8\text{V}$, $10\text{mA} \leq I_{\text{OUT}} \leq 5\text{A}$, $6.6\text{V} \leq V_{\text{IN}} \leq 10\text{V}$	4.95 4.9	5 5	5.05 5.1	V
Line Regulation	ΔV_{OUT}	SP1084-ADJ, $I_{\text{OUT}} = 10\text{mA}$, $2.85\text{V} \leq V_{\text{IN}} \leq 10\text{V}$		0.015 0.035	0.2 0.2	%
		SP1084-1.5, $I_{\text{OUT}} = 10\text{mA}$, $3.1\text{V} \leq V_{\text{IN}} \leq 10\text{V}$		0.5 1	6 6	mV
		SP1084-1.8, $I_{\text{OUT}} = 10\text{mA}$, $3.4\text{V} \leq V_{\text{IN}} \leq 10\text{V}$		0.5 1	6 6	mV
		SP1084-2.5, $I_{\text{OUT}} = 10\text{mA}$, $4.1\text{V} \leq V_{\text{IN}} \leq 10\text{V}$		0.5 1	6 6	mV
		SP1084-2.85, $I_{\text{OUT}} = 10\text{mA}$, $4.5\text{V} \leq V_{\text{IN}} \leq 10\text{V}$		0.5 1	6 6	mV
		SP1084-3.3, $I_{\text{OUT}} = 10\text{mA}$, $4.9\text{V} \leq V_{\text{IN}} \leq 10\text{V}$		0.5 1	6 6	mV
		SP1084-5.0, $I_{\text{OUT}} = 10\text{mA}$, $6.6\text{V} \leq V_{\text{IN}} \leq 10\text{V}$		0.5 1	10 10	mV

Electrical Characteristics (Continued)

Typicals and limits appearing in normal type apply for $T_J = 25^\circ\text{C}$. Limits appearing in **Boldface** type apply over the entire operating junction temperature range.

Parameter	Symbol	Conditions	Min	Typ	Max	Unit
Load Regulation	ΔV_{OUT}	SP1084-ADJ, $0\text{mA} \leq I_{OUT} \leq 5\text{A}$, $V_{IN} - V_{OUT} = 3\text{V}$		0.1 0.2	0.3 0.4	%
		SP1084-1.5, $0\text{mA} \leq I_{OUT} \leq 5\text{A}$, $V_{IN} - V_{OUT} = 3\text{V}$		3 7	15 20	mV
		SP1084-1.8, $0\text{mA} \leq I_{OUT} \leq 5\text{A}$, $V_{IN} - V_{OUT} = 3\text{V}$		3 7	15 20	mV
		SP1084-2.5, $0\text{mA} \leq I_{OUT} \leq 5\text{A}$, $V_{IN} - V_{OUT} = 3\text{V}$		3 7	15 20	mV
		SP1084-2.85, $0\text{mA} \leq I_{OUT} \leq 5\text{A}$, $V_{IN} - V_{OUT} = 3\text{V}$		3 7	15 20	mV
		SP1084-3.3, $0\text{mA} \leq I_{OUT} \leq 5\text{A}$, $V_{IN} - V_{OUT} = 3\text{V}$		3 7	15 20	mV
		SP1084-5.0, $0\text{mA} \leq I_{OUT} \leq 5\text{A}$, $V_{IN} - V_{OUT} = 3\text{V}$		5 10	20 35	mV
Dropout Voltage		$I_O = 5\text{A}$, $\Delta V_{REF}, \Delta V_{OUT} = 1\%$		1.3	1.5	V
Current Limit	I_{LIMIT}	$V_{IN} - V_{OUT} = 3\text{V}$,	5.5	6.5		A
Minimum Load Current		$V_{IN} = 10\text{V}$ (SP1084-ADJ)		3	10	mA
Quiescent Current		$V_{IN} = 10\text{V}$ (SP1084)		5	10	mA
Ripple Rejection		$f_{RIPPLE} = 120\text{Hz}$, $C_{OUT} = 25\mu\text{F}$ Tantalum, $I_{OUT} = 5\text{A}$, $V_{IN} - V_{OUT} = 3\text{V}$	60	72		dB
Adjust Pin Current		$V_{IN} = 4.25\text{V}$, $I_{OUT} = 10\text{mA}$		55	120	μA
Adjust Pin Current Change		$10\text{mA} \leq I_{OUT} \leq 5\text{A}$, $1.5\text{V} \leq (V_{IN} - V_{OUT}) \leq 4.5\text{V}$		0.2	5	μA
Temperature Stability		$I_{OUT} = 10\text{mA}$, $V_{IN} - V_{OUT} = 1.5$		0.5		%
Long Term Stability		$T_A = 125^\circ\text{C}$, 1000Hrs		0.5		%
RMS Noise (% of V_{OUT})		$10\text{Hz} \leq f \leq 10\text{kHz}$		0.003		%
Thermal Resistance Junction -to-Case	θ_{JC}	TO-263 TO-220 TO-252		3 3 4		$^\circ\text{C}/\text{W}$

Typical Performance Characteristics

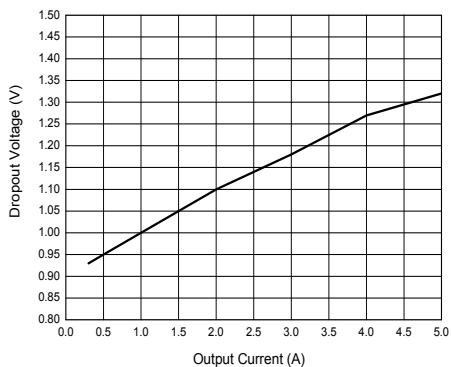

Figure 4. Dropout Voltage vs. Output Current

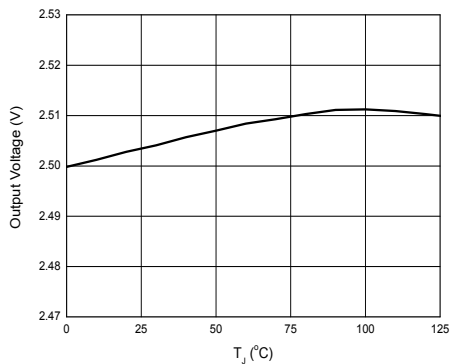

Figure 5. Output Voltage vs. Temperature

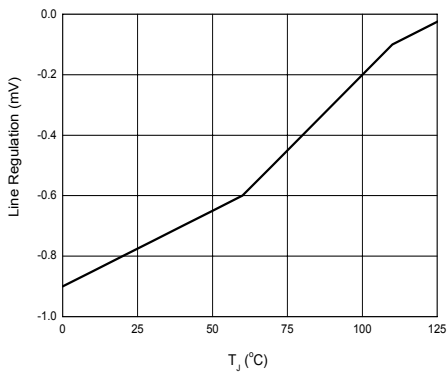

Figure 6. Line Regulation vs. Temperature

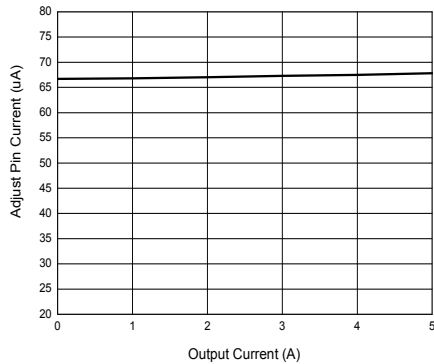

Figure 7. Adjust Pin Current vs. Output Current

Typical Performance Characteristics (Continued)

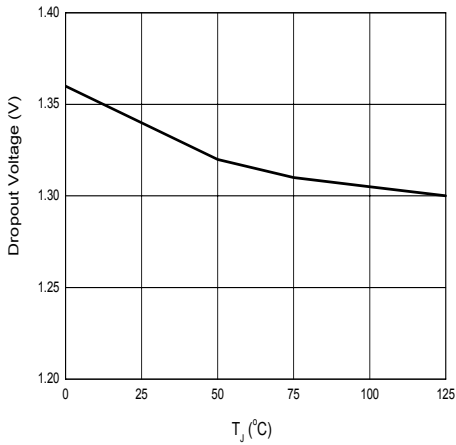

Figure 8. Dropout Voltage vs. Temperature

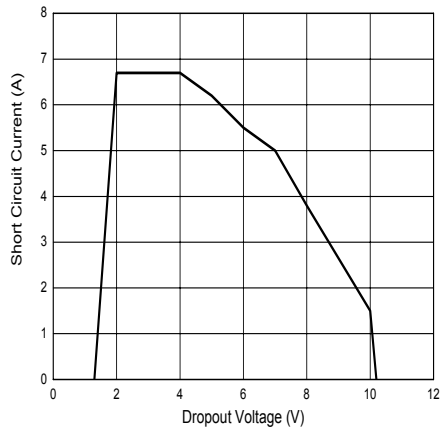

Figure 9. Short Circuit Current vs. Dropout Voltage

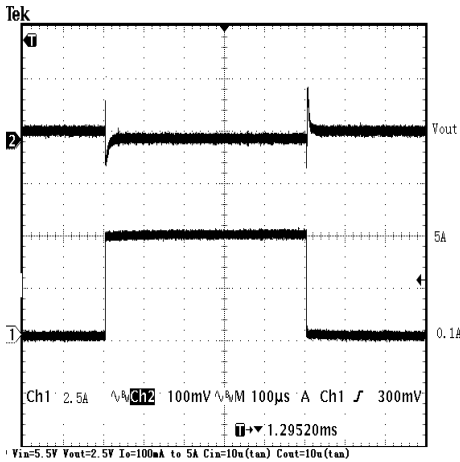

Figure 10. Load Transient Response

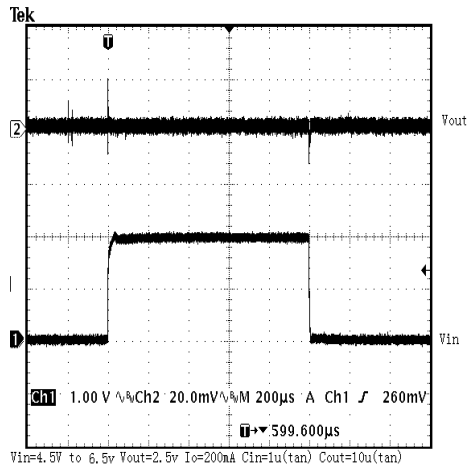

Figure 11. Line Transient Response

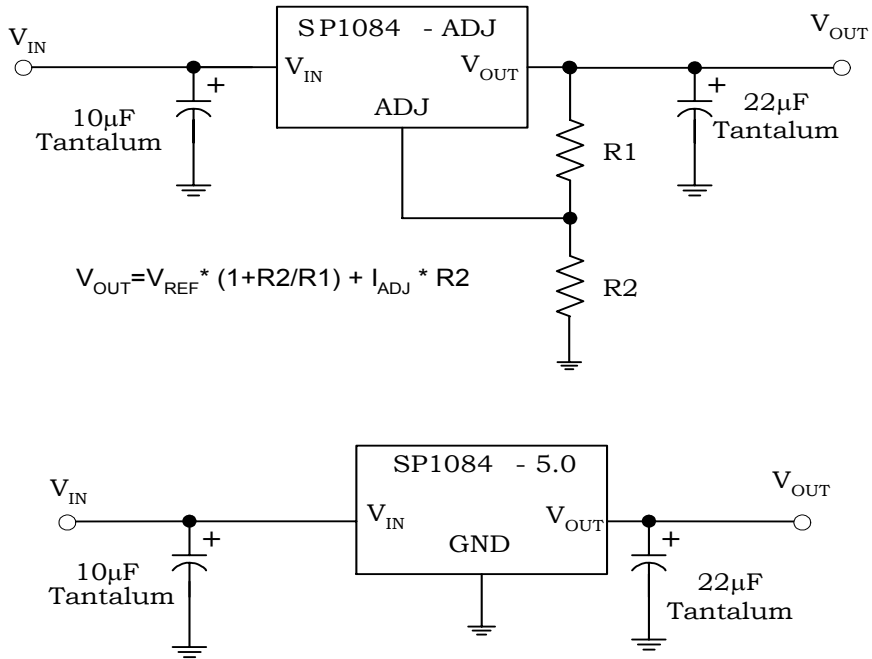
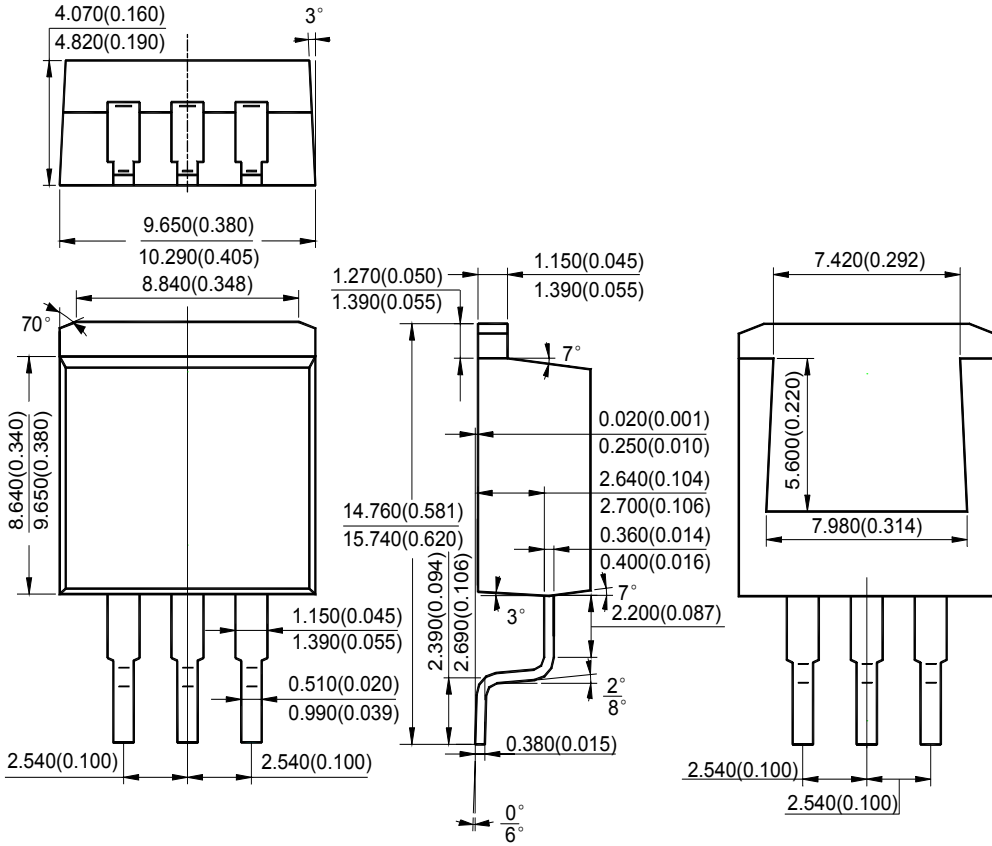

Figure 12. Typical Applications of SP1084

Mechanical Dimensions

TO-263-3

Unit: mm(inch)



Mechanical Dimensions (Continued)

TO-220

Unit: mm(inch)

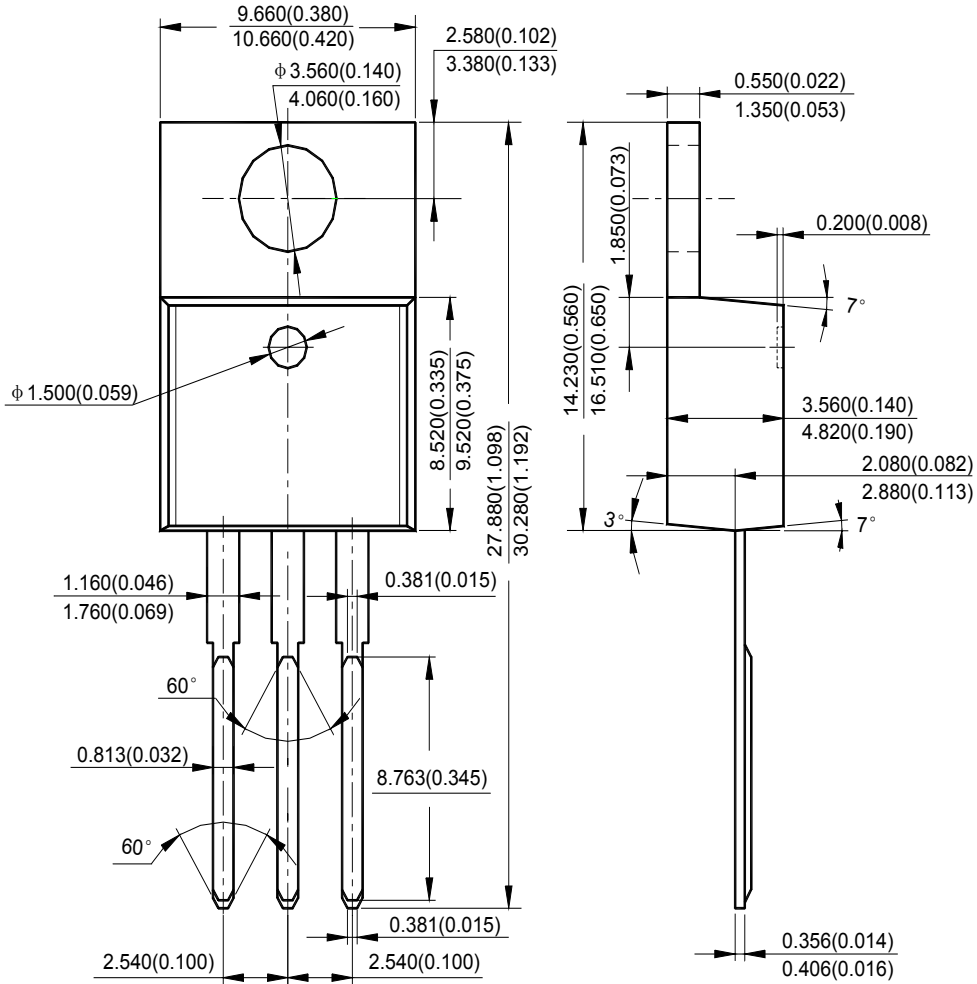

Mechanical Dimensions (Continued)

TO-252

Unit: mm(inch)

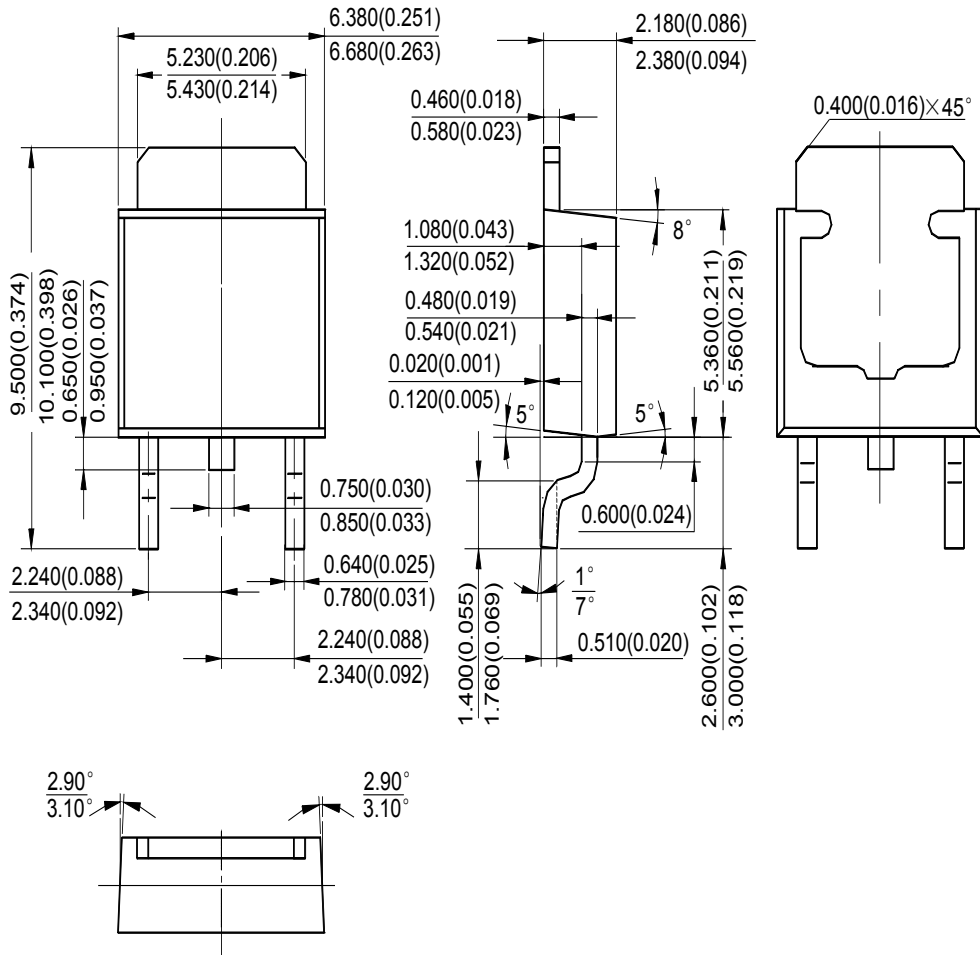

ORDERING INFORMATION

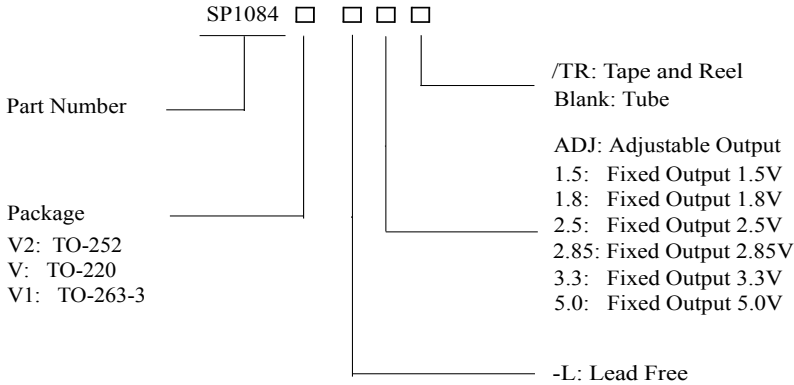

Part Number	Voltage Range	Temperature Range	Package	Pin Count	Pack Qty
SP1084V2-L/TR	Adj	0°C to +125°C	TO-252	2	2,500/TR
SP1084V2-L-1-5/TR	1.5V	0°C to +125°C	TO-252	2	2,500/TR
SP1084V2-L-1-8/TR	1.8V	0°C to +125°C	TO-252	2	2,500/TR
SP1084V2-L-2-5/TR	2.5V	0°C to +125°C	TO-252	2	2,500/TR
SP1084V2-L-2-85/TR	2.85V	0°C to +125°C	TO-252	2	2,500/TR
SP1084V2-L-3-3/TR	3.3V	0°C to +125°C	TO-252	2	2,500/TR
SP1084V2-L-5-0/TR	5V	0°C to +125°C	TO-252	2	2,500/TR
SP1084V1-L/TR	Adj	0°C to +125°C	TO-263	3	800/TR
SP1084V1-L-1-5/TR	1.5V	0°C to +125°C	TO-263	3	800/TR
SP1084V1-L-1-8/TR	1.8V	0°C to +125°C	TO-263	3	800/TR
SP1084V1-L-2-5/TR	2.5V	0°C to +125°C	TO-263	3	800/TR
SP1084V1-L-2-85/TR	2.85V	0°C to +125°C	TO-263	3	800/TR
SP1084V1-L-3-3/TR	3.3V	0°C to +125°C	TO-263	3	800/TR
SP1084V1-L-5-0/TR	5V	0°C to +125°C	TO-263	3	800/TR
SP1084V-L	Adj	0°C to +125°C	TO-220	3	50/TUBE
SP1084V-L-1-5	1.5V	0°C to +125°C	TO-220	3	50/TUBE
SP1084V-L-1-8	1.8V	0°C to +125°C	TO-220	3	50/TUBE
SP1084V-L-2-5	2.5V	0°C to +125°C	TO-220	3	50/TUBE
SP1084V-L-2-85	2.85V	0°C to +125°C	TO-220	3	50/TUBE
SP1084V-L-3-3	3.3V	0°C to +125°C	TO-220	3	50/TUBE
SP1084V-L-5-0	5V	0°C to +125°C	TO-220	3	50/TUBE



Sipex Corporation

Headquarters and Sales Office
233 South Hillview Drive
Milpitas, CA 95035
TEL: (408) 934-7500
FAX: (408) 935-7600

Sipex Corporation reserves the right to make changes to any products described herein. Sipex does not assume any liability arising out of the application or use of any product or circuit described herein; neither does it convey any license under its patent rights nor the rights of others.