

No.	Changes and/or Note No.	Date	Intr.	No.	Changes and/or Note No.	Date	Intr.

MATERIALS:

PLASTIC HOUSING: ENGINEERING THERMOPLASTIC
 FLAMMABILITY RATING UL 94V-0.

CONTACTS: 0.35MM THICKNESS PHOSPHOR BRONZE

PLATING: GOLD PLATING OVER NICKEL IN CONTACT.

TIN PLATING OVER NICKEL IN SOLDER AREA.

SHIELDED: BRASS WITH NICKEL PLATED

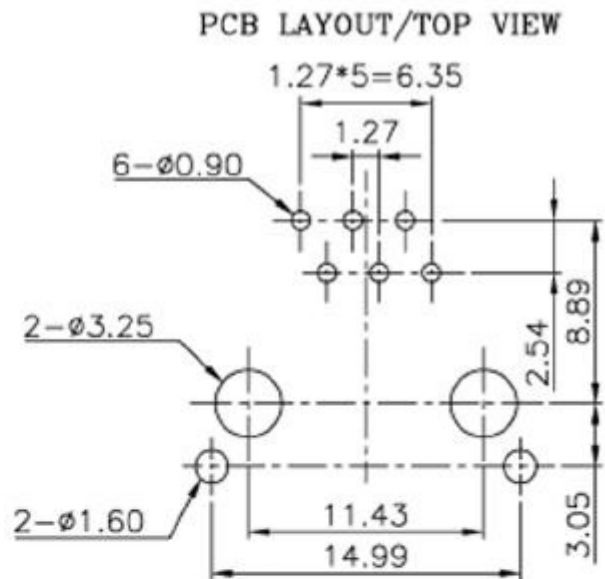
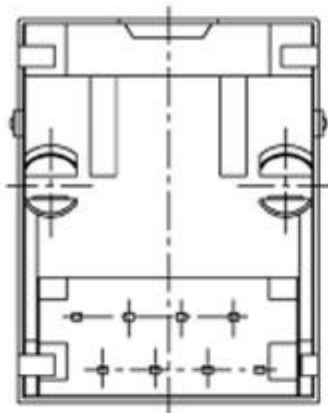
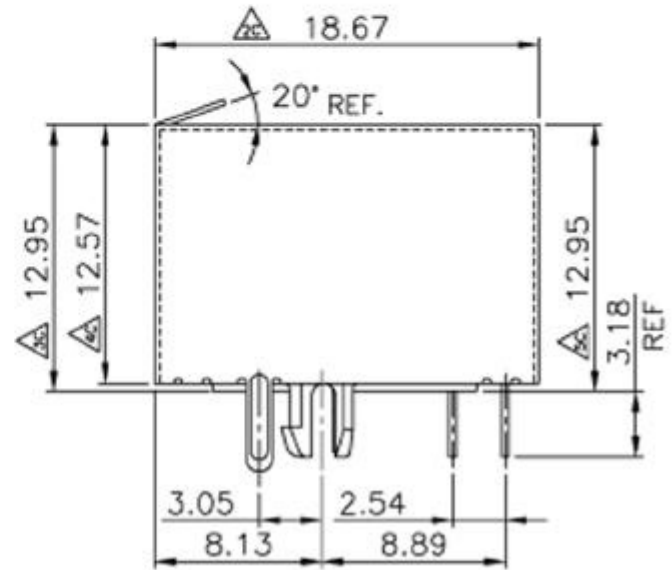
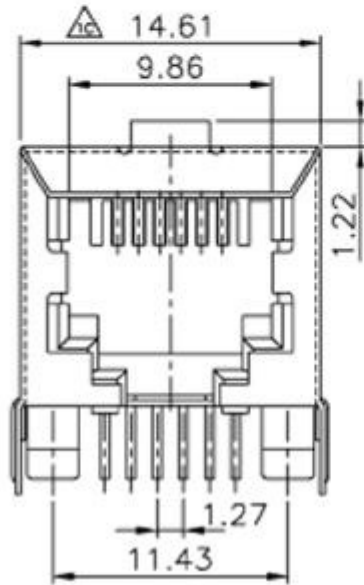

DATE 041101	DRAWN MRR	SCALE	MATERIAL TYPE
	APPROVED		REPLACES

 Eldon Electronics AB	MHRJJ66NFRAS Modular Connector		DRAWING No
			146