

Spezifikation für Freigabe / specification for release

Kunde / customer :

Artikelnummer / part number :

744232090

LF



Bezeichnung : **SMD Stromkomp. Datenleitungsfilter WE-CNSW**

description : **SMD common mode noise suppressor WE-CNSW**

DATUM / DATE : 2004-10-11

A Mechanische Abmessungen / dimensions:

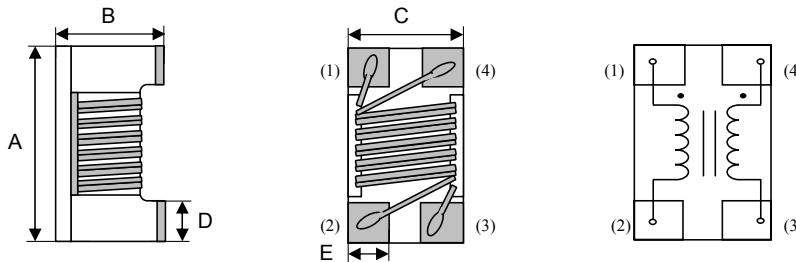

	1206	
A	3,2 ± 0,2	mm
B	1,9 ± 0,2	mm
C	1,6 ± 0,2	mm
D	0,6 ref.	mm
E	0,6 ref.	mm

B Elektrische Eigenschaften / electrical properties:

Eigenschaften / properties	Testbedingungen / test conditions		Wert / value	Einheit / unit	tol.
Impedanz / impedance	100 MHz	Z	90	Ω	± 25 %
Nennspannung / rated voltage		U	50	V	max.
DC-Widerstand / DC-resistance	@ 20°C	R _{DC}	0,30	Ω	max.
Nennstrom / rated current	ΔT= 15 K	I _{DC}	370	mA	max.

C Lötpad / soldering spec.:

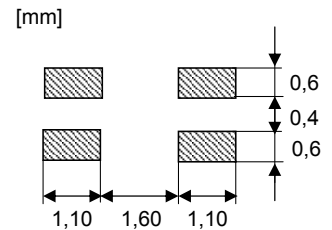

D Prüfgeräte / test equipment:

HP 4191 B für/for Z und/and L

HP 34401 A für/for R_{DC} und/and I_{DC}

E Testbedingungen / test conditions:

Luftfeuchtigkeit / humidity: 33%
 Umgebungstemperatur / temperature: +20°C

F Werkstoffe & Zulassungen / material & approvals:

Basismaterial / base material: Ferrit

G Eigenschaften / general specifications:

Lagertemperatur / storage temperature: -40°C - + 125°C
 Betriebstemp. / operating temperature: -40°C - + 125°C

Freigabe erteilt / general release:	Kunde / customer		
Datum / date	Unterschrift / signature		
	Würth Elektronik		
Geprüft / checked	MST	Version 3	04-10-11
	SST	Version 2	04-02-17
	MST	Version 1	03-11-25
	Name	Änderung / modification	Datum / date

Würth Elektronik eiSos GmbH & Co. KG

D-74638 Waldenburg · Max-Eyth-Strasse 1 -3 · Germany · Telefon (+49) (0) 7942 - 945 - 0 · Telefax (+49) (0) 7942 - 945 - 400
<http://www.we-online.com>

Spezifikation für Freigabe / specification for release

Kunde / customer : _____
 Artikelnummer / part number : **744232090** LF
 Bezeichnung : **SMD Stromkomp. Datenleitungsfilter WE-CNSW**
 description : **SMD common mode noise suppressor WE-CNSW**



H Impedanzverlauf / impedance curve:

DATUM / DATE : 2004-10-11

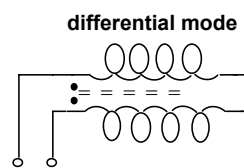
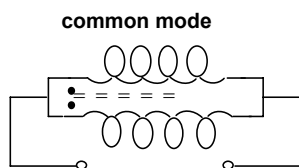
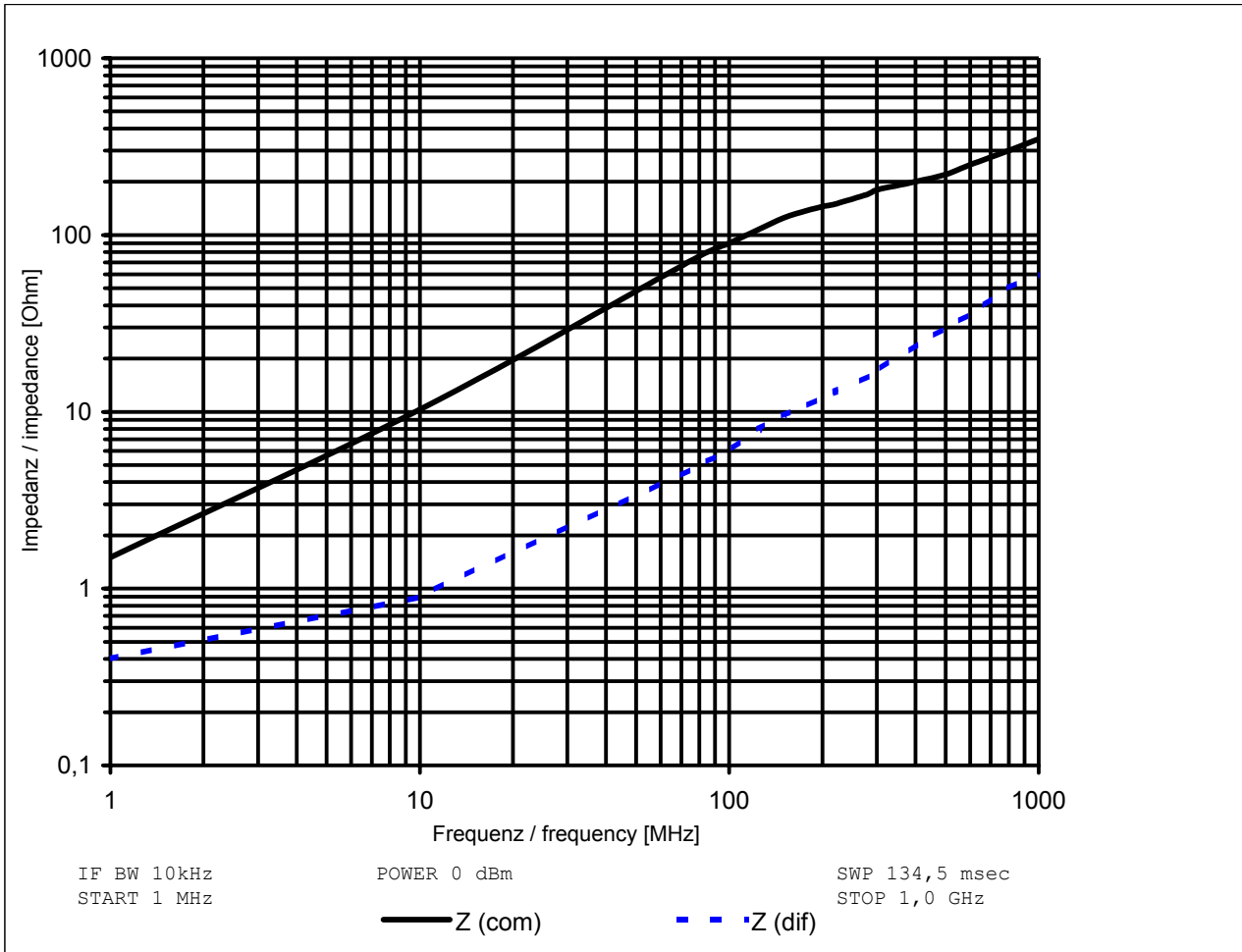

Freigabe erteilt / general release:	Kunde / customer			
.....			
Datum / date	Unterschrift / signature			
.....	Würth Elektronik	MST	Version 3	04-10-11
.....	SST	Version 2	04-02-17
.....	MST	Version 1	03-11-25
Geprüft / checked	Kontrolliert / approved	Name	Änderung / modification	Datum / date

Würth Elektronik eiSos GmbH & Co. KG

D-74638 Waldenburg · Max-Eyth-Strasse 1 -3 · Germany · Telefon (+49) (0) 7942 - 945 - 0 · Telefax (+49) (0) 7942 - 945 - 400
<http://www.we-online.com>

Spezifikation für Freigabe / specification for release

Kunde / customer : _____
 Artikelnummer / part number : **744232090** LF
 Bezeichnung : **SMD Stromkomp. Datenleitungsfilter WE-CNSW**
 description : **SMD common mode noise suppressor WE-CNSW**



DATUM / DATE : 2004-10-11

I Rollenspezifikation / tape and reel specifications:

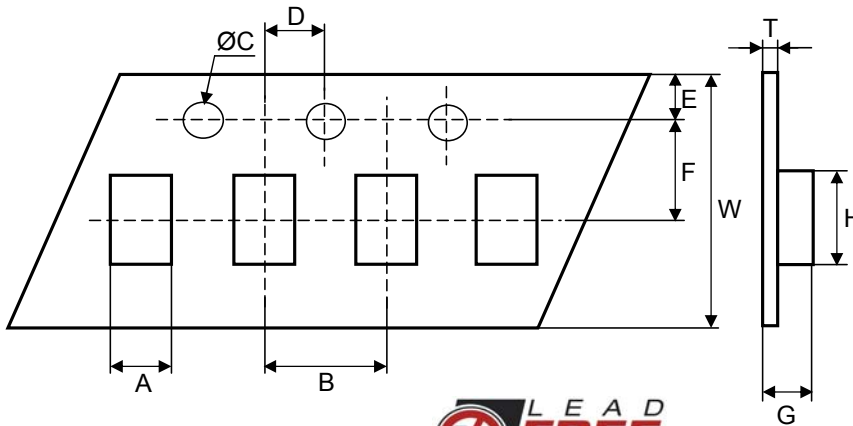

Gurtspezifikation / Tape specification:

A	1,90 ± 0,1	mm
B	4,00 ± 0,1	mm
C	1,50 ± 0,05	mm
D	2,00 ± 0,1	mm
E	1,75 ± 0,1	mm
F	3,50 ± 0,1	mm
G	2,10 ± 0,1	mm
H	3,50 ± 0,1	mm
W	8,00 ± 0,1	mm
T	0,23 ± 0,05	mm

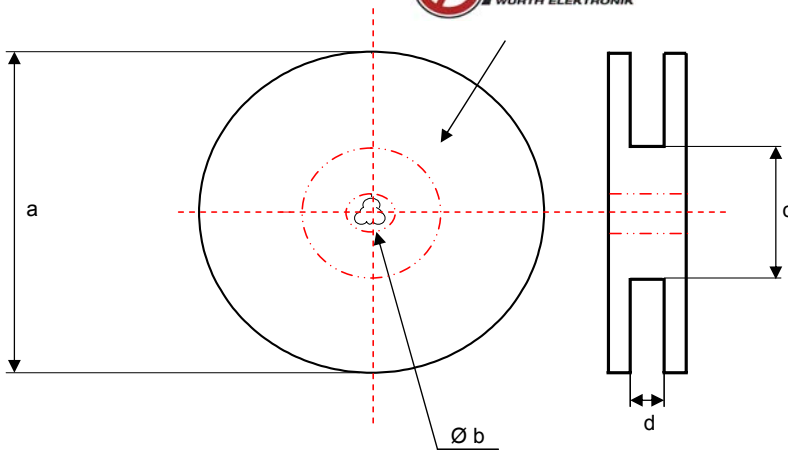

Rollenspezifikation / Reel Specification:

a	178,0 ± 0,1	mm
b	21,00 ± 0,1	mm
c	50,00 ± 0,1	mm
d	10,00 ± 0,1	mm

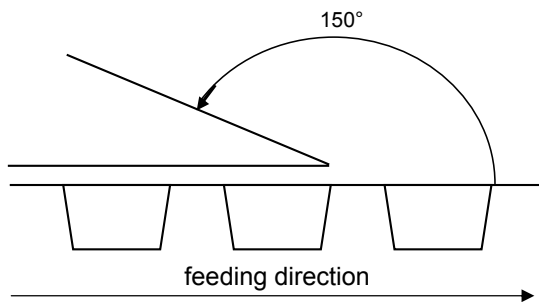

The force of tearing off cover tape is 0,2 to 0,7 N in arrow direction.

Freigabe erteilt / general release:	Kunde / customer			
Datum / date	Unterschrift / signature			
	Würth Elektronik	MST	Version 3	04-10-11
		SST	Version 2	04-02-17
		MST	Version 1	03-11-25
Geprüft / checked	Kontrolliert / approved	Name	Änderung / modification	Datum / date

This electronic component is designed and developed with the intention for use in general electronics equipments. Before incorporating the components into any equipments in the field such as aerospace, aviation, nuclear control, submarine, transportation, (automotive control, train control, ship control), transportation signal, disaster prevention, medical, public information network etc. where higher safety and reliability are especially required or if there is possibility of direct damage or injury to human body. In addition, even electronic component in general electronic equipments, when used in electrical circuits that require high safety, reliability functions or performance, the sufficient reliability evaluation-check for the safety must be performed before use. It is essential to give consideration when to install a protective circuit at the design stage.

Würth Elektronik eiSos GmbH & Co. KG

D-74638 Waldenburg · Max-Eyth-Strasse 1-3 · Germany · Telefon (+49) (0) 7942 - 945 - 0 · Telefax (+49) (0) 7942 - 945 - 400
<http://www.we-online.com>