

FEATURES

- Dual-axis sensing, $\pm 70 g$, $\pm 37 g$**
- 14-bit resolution**
- Impact peak-level sample-and-hold**
- RSS output**
- Programmable event recorder**
- 400 Hz double-pole Bessel sensor response**
- Digitally controlled sensitivity and bias**
- Digitally controlled sample rate, up to 4096 SPS**
- Programmable condition monitoring alarms**
- Auxiliary digital I/O**
- Digitally activated self-test**
- Embedded temperature sensor**
- Programmable power management**
- SPI-compatible serial interface**
- Auxiliary 12-bit ADC input and DAC output**
- Single-supply operation: +3.0 V to +3.6 V**
- 4000 *g* powered shock survivability**

APPLICATIONS

- Crash or impact detection**
- Condition monitoring of valuable goods**
- Safety, shut-off sensing**
- Impact event recording**
- Security sensing, tamper detection**

GENERAL DESCRIPTION

The ADIS16204 is a fully-contained programmable impact sensor in a single compact package enabled by the Analog Devices, Inc. *iSensor™* integration. By enhancing the Analog Devices *iMEMS®* sensor technology with an embedded signal processing solution, the ADIS16204 provides tunable digital sensor data in a convenient format that can be accessed using a serial peripheral interface (SPI). The SPI provides access to measurements for dual-axis linear acceleration, a root sum square (RSS) of both axes, temperature, power supply, an auxiliary analog input, and an event capture buffer memory. Easy access to digital sensor data provides users with a system-ready device, reducing development time, cost, and program risk.

Unique characteristics of the end system are accommodated easily through several built-in features, such as a single command in-system bias null/offset calibration, along with convenient sample rate control.

Rev. A

Information furnished by Analog Devices is believed to be accurate and reliable. However, no responsibility is assumed by Analog Devices for its use, nor for any infringements of patents or other rights of third parties that may result from its use. Specifications subject to change without notice. No license is granted by implication or otherwise under any patent or patent rights of Analog Devices. Trademarks and registered trademarks are the property of their respective owners.

FUNCTIONAL BLOCK DIAGRAM

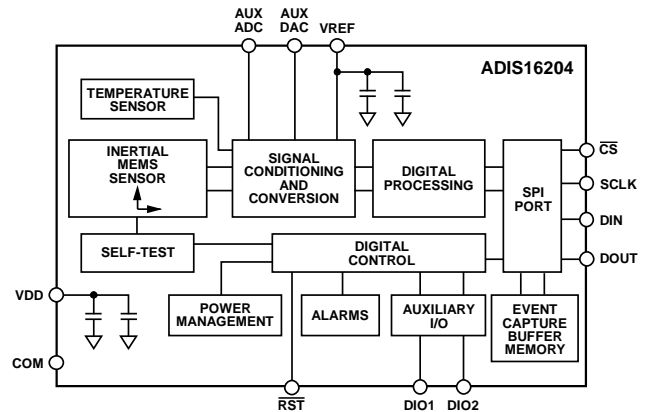

Figure 1.

The ADIS16204 offers the following embedded features, which eliminate the need for external circuitry and provide a simplified system interface:

- Peak sample-and-hold
- Programmable event recording (dual, 1K × 16 bit)
- RSS output (total shock in the XY plane)
- Configurable alarms
- Auxiliary 12-bit ADC and DAC
- Configurable digital I/O port
- Digital self-test function

The ADIS16204 offers two power management features for managing system-level power dissipation: low power mode and a configurable shutdown feature.

The ADIS16204 is available in a 9.2 mm × 9.2 mm × 3.9 mm laminate-based land grid array (LGA) package with a temperature range of -40°C to $+105^{\circ}\text{C}$.

TABLE OF CONTENTS

Features	1	Impact/Shock Response	10
Applications.....	1	Auxiliary ADC Function.....	11
Functional Block Diagram	1	Basic Operation	12
General Description	1	Serial Peripheral Interface.....	12
Revision History	2	Data Output Register Access	13
Specifications.....	3	Programming and Control.....	14
Timing Specifications	5	Control Register Overview	14
Absolute Maximum Ratings.....	6	Control Register Structure	14
ESD Caution.....	6	Global Commands	15
Pin Configuration and Function Descriptions.....	7	Calibration.....	15
Recommended Pad Geometry.....	7	Operational Control.....	16
Typical Performance Characteristics	8	Status and Diagnostics.....	17
Theory of Operation	10	Alarm Detection and Event Capture	18
Overview.....	10	Second-Level Assembly	21
Acceleration Sensor.....	10	Outline Dimensions	22
Temperature Sensor	10	Ordering Guide	22

REVISION HISTORY

10/07—Rev. 0 to Rev. A

Changes to Power Supply Current Specification.....	4
Changes to Overview Section	10

6/07—Revision 0: Initial Version

SPECIFICATIONS

$T_A = -40^\circ\text{C}$ to $+105^\circ\text{C}$, $V_{DD} = 3.3\text{ V}$, unless otherwise noted.

Table 1.

Parameter	Conditions	Axis	Min	Typ	Max	Unit
ACCELEROMETER						
Output Full-Scale Range		X	± 70			<i>g</i>
		Y	± 37			<i>g</i>
Sensitivity		X		17.125		mg/LSB
		Y		8.407		mg/LSB
Nonlinearity				0.2		%
Sensor-to-Sensor Alignment Error				0.1		Degrees
Cross-Axis Sensitivity			-5		+5	%
Resonant Frequency				24		kHz
OFFSET						
Zero- <i>g</i> Output ¹		X		0.2		<i>g</i>
		Y		0.2		<i>g</i>
NOISE						
Noise Density	10 Hz – 400 Hz, no postfiltering			1.8		mg/ $\sqrt{\text{Hz}}$
FREQUENCY RESPONSE						
Sensor Bandwidth (-3 dB)	2-pole Bessel		360	400	440	Hz
Temperature Drift	$ 25^\circ\text{C} - T_{\text{MIN}} $ or $ T_{\text{MAX}} - 25^\circ\text{C} $			2		Hz
ACCELEROMETER SELF-TEST STATE²						
Output Change When Active	At 25°C	X		254		LSB
Output Change When Active		Y		518		LSB
TEMPERATURE SENSOR						
Output at 25°C				1278		LSB
Scale Factor				-2.13		LSB/ $^\circ\text{C}$
ADC INPUT						
Resolution				12		Bits
Integral Nonlinearity (INL)				± 2		LSB
Differential Nonlinearity (DNL)				± 1		LSB
Offset Error				± 4		LSB
Gain Error				± 2		LSB
Input Range			0		2.5	V
Input Capacitance	During acquisition			20		pF
ON-CHIP VOLTAGE REFERENCE						
Accuracy	At 25°C		-10	2.5	+10	V
Reference Temperature Coefficient				± 40		ppm/ $^\circ\text{C}$
Output Impedance				70		Ω
DAC OUTPUT						
Resolution	5 k Ω /100 pF to GND			12		Bits
Relative Accuracy	For Code 101 to Code 4095			4		LSB
Differential Nonlinearity (DNL)				1		LSB
Offset Error				± 5		mV
Gain Error				± 0.5		%
Output Range				0 to 2.5		V
Output Impedance				2		Ω
Output Settling Time				10		μs

ADIS16204

Parameter	Conditions	Axis	Min	Typ	Max	Unit
LOGIC INPUTS ³			2.0			V
Input High Voltage, V_{INH}					0.8	V
Input Low Voltage, V_{INL}				± 0.2	± 1	μA
Logic 1 Input Current, I_{INH}	$V_{IH} = V_{DD}$			-40	-60	μA
Logic 0 Input Current, I_{INL}	$V_{IL} = 0 V$			10		pF
DIGITAL OUTPUTS						
Output High Voltage, V_{OH}	$I_{SOURCE} = 1.6 mA$		2.4			V
Output Low Voltage, V_{OL}	$I_{SINK} = 1.6 mA$				0.4	V
SLEEP TIMER						
Timeout Period ⁴			0.5		128	Seconds
START-UP TIME						
Initial				130		ms
Reset recovery				2.5		ms
FLASH MEMORY						
Endurance ⁵			20,000			Cycles
Data Retention ⁶	$T_J = 85^\circ C$		20			Years
CONVERSION RATE						
Maximum Throughput Rate				4096		SPS
Minimum Throughput Rate				2.066		SPS
POWER SUPPLY						
Operating Voltage Range, V_{DD}			3.0	3.3	3.6	V
Power Supply Current	Normal mode, $SMPL_PRD \geq 0x08$ ($f_s \leq 910 Hz$), at $25^\circ C$			12	15	mA
	Fast mode, $SMPL_PRD \leq 0x07$ ($f_s \geq 1024 Hz$), at $25^\circ C$			37	43	mA
	Sleep mode, at $25^\circ C$			150		μA

¹ Note that gravity can impact this number; zero- g condition assumes both axes oriented normal to the earth's gravity.

² Self-test response changes as the square of V_{DD} .

³ Note that the inputs are +5 V tolerant.

⁴ Guaranteed by design.

⁵ Endurance is qualified as per JEDEC Standard 22, Method A117 and measured at $-40^\circ C$, $+25^\circ C$, $+85^\circ C$, and $+105^\circ C$.

⁶ Retention lifetime equivalent at junction temperature (T_J), $55^\circ C$ as per JEDEC Standard 22, Method A117. Retention lifetime decreases with junction temperature.

TIMING SPECIFICATIONS

$T_A = +25^\circ\text{C}$, $V_{CC} = +3.3\text{ V}$, unless otherwise noted.

Table 2.

Parameter	Description	Min ¹	Typ	Max ¹	Unit
f_{SCLK}	Fast mode ²	0.01		2.5	MHz
	Normal mode ²	0.01		1.0	MHz
t_{DATARATE}	Chip select period, fast mode ²	40			μs
	Chip select period, normal mode ²	100			μs
t_{CSHIGH}	Chip select high	$1/f_{\text{SCLK}}$			
t_{CS}	Chip select to clock edge	48.8			ns
t_{DAV}	Data output valid after SCLK edge			100	ns
t_{DSU}	Data input setup time before SCLK rising edge	24.4			ns
t_{DHD}	Data input hold time after SCLK rising edge	48.8			ns
t_{DF}	Data output fall time		5	12.5	ns
t_{DR}	Data output rise time		5	12.5	ns
t_{SFS}	$\overline{\text{CS}}$ high after SCLK edge	5			ns

¹ Guaranteed by design; typical specifications are not tested or guaranteed.

² Based on sample rate selection.

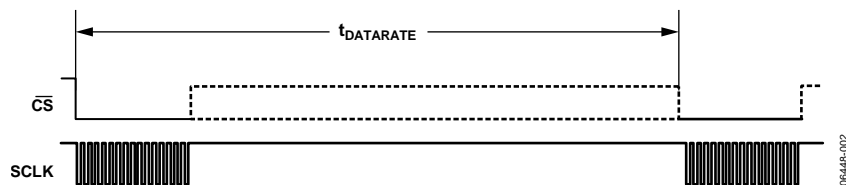

Figure 2. SPI Chip Select Timing

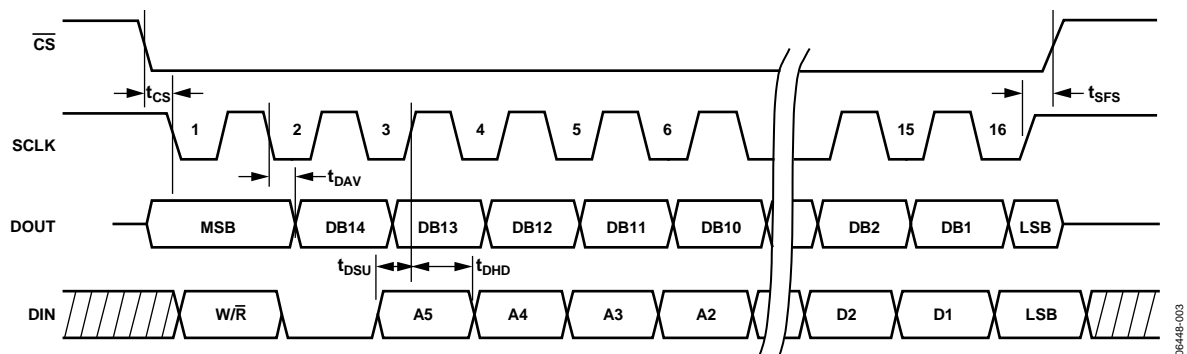

Figure 3. SPI Timing
(Utilizing SPI Settings Typically Identified as Phase = 1, Polarity = 1)

ABSOLUTE MAXIMUM RATINGS

Table 3.

Parameter	Rating
Acceleration (Any Axis, Unpowered, 0.5 ms)	4000 <i>g</i>
Acceleration (Any Axis, Powered, 0.5 ms)	4000 <i>g</i>
V _{CC} to COM	−0.3 V to +6.0 V
Digital Input/Output Voltage to COM	−0.3 V to +5.5 V
Analog Inputs to COM	−0.3 V to +3.5 V
Operating Temperature Range	−40°C to +125°C
Storage Temperature Range	−65°C to +150°C

Stresses above those listed under Absolute Maximum Ratings may cause permanent damage to the device. This is a stress rating only; functional operation of the device at these or any other conditions above those indicated in the operational section of this specification is not implied. Exposure to absolute maximum rating conditions for extended periods may affect device reliability.

ESD CAUTION



ESD (electrostatic discharge) sensitive device. Charged devices and circuit boards can discharge without detection. Although this product features patented or proprietary protection circuitry, damage may occur on devices subjected to high energy ESD. Therefore, proper ESD precautions should be taken to avoid performance degradation or loss of functionality.

PIN CONFIGURATION AND FUNCTION DESCRIPTIONS

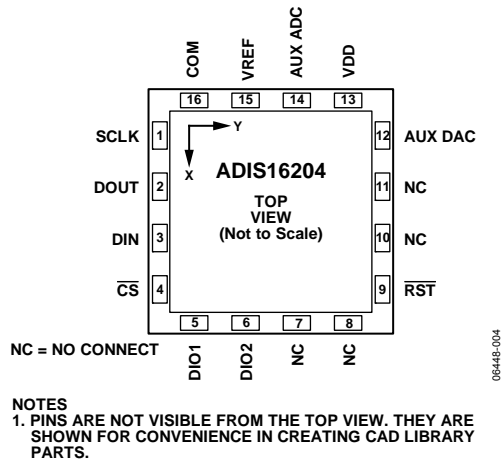

Figure 4. Pin Configuration

Table 4. Pin Function Descriptions

Pin No.	Mnemonic	Type ¹	Description
1	SCLK	I	SPI, Serial Clock.
2	DOUT	O	SPI, Data Out.
3	DIN	I	SPI, Data In.
4	\overline{CS}	I	SPI, Chip Select, Active Low.
5, 6	DIO1, DIO2	I/O	Multifunction Digital Input/Output Pins.
7, 8, 10, 11	NC	-	No Connect.
9	\overline{RST}	I	Reset, Active Low. This input resets the embedded microcontroller to a known state.
12	AUX DAC	O	Auxiliary DAC Analog Voltage Output.
13	VDD	S	+3.3 V Power Supply.
14	AUX ADC	I	Auxiliary ADC Analog Input Voltage.
15	VREF	O	Precision Reference Output.
16	COM	S	Common. Reference point for all circuitry.

¹S = supply; O = output; I = input.

RECOMMENDED PAD GEOMETRY

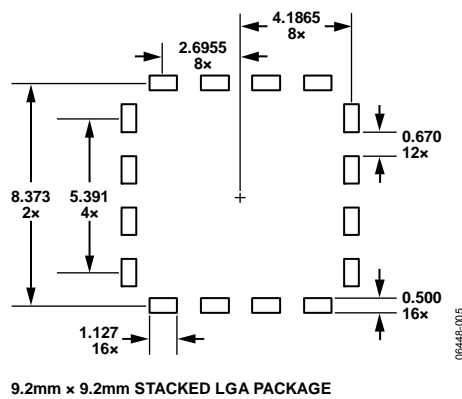

Figure 5. Example of a Pad Layout

TYPICAL PERFORMANCE CHARACTERISTICS

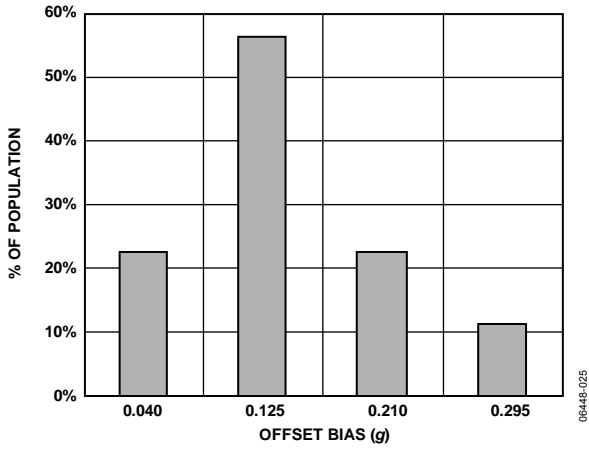

Figure 6. Bias Offset Distribution, X-Axis

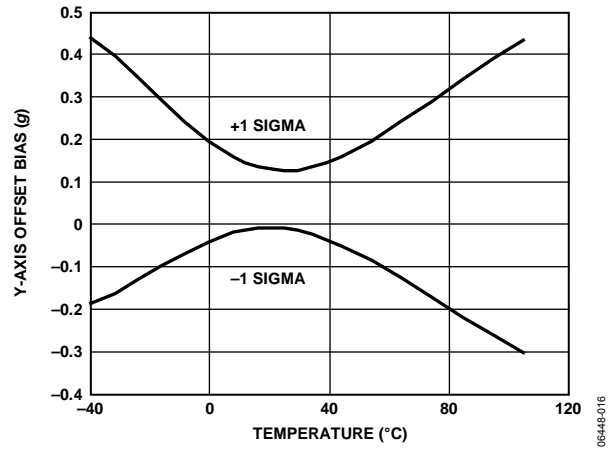

Figure 9. Offset Bias Change vs. Temperature, Y-Axis

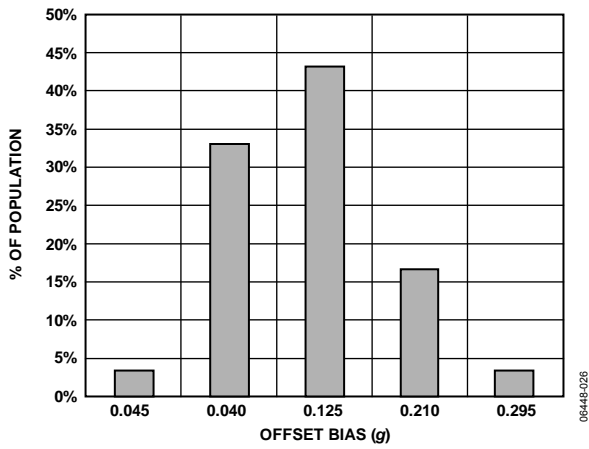

Figure 7. Bias Offset Distribution, Y-Axis

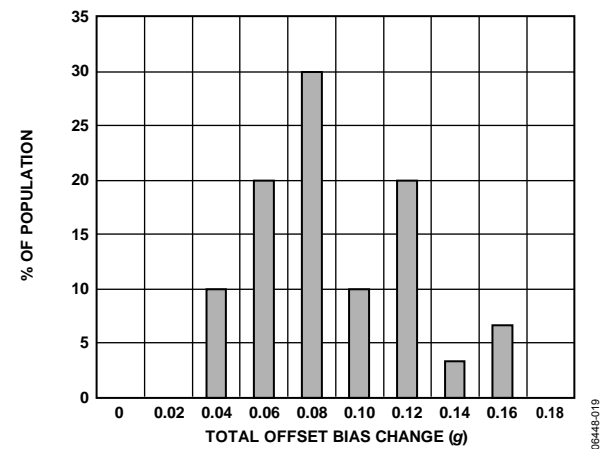

Figure 10. Offset Bias Change, X-Axis vs. Power Supply (3.0 V to 3.6 V)

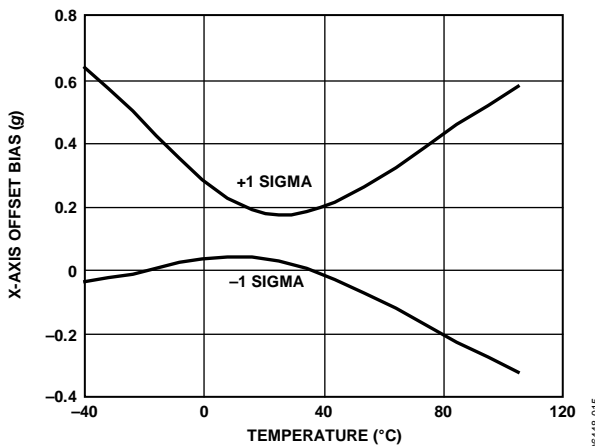

Figure 8. Offset Bias Change vs. Temperature, X-Axis

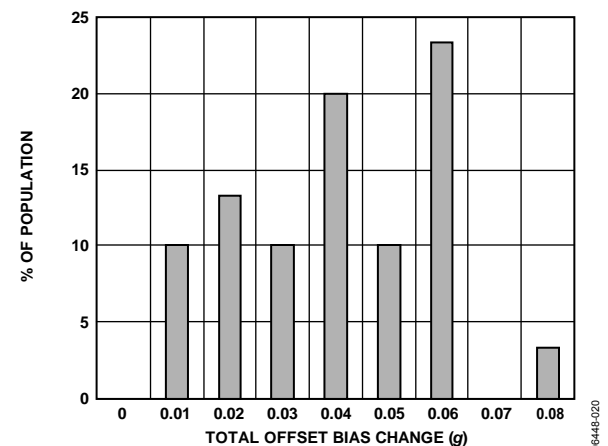

Figure 11. Offset Bias Change, Y-Axis vs. Power Supply (3.0 V to 3.6 V)

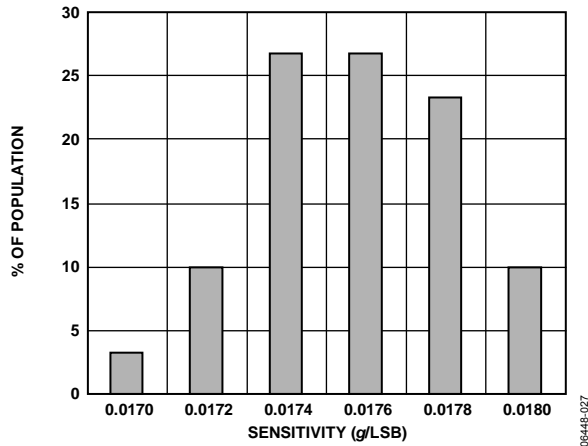

Figure 12. X-Axis Sensitivity Distribution

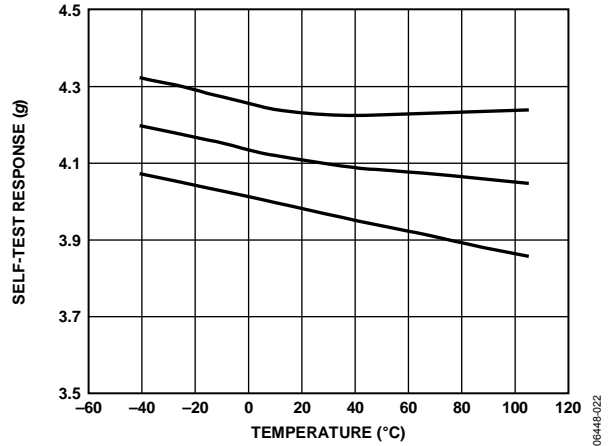

Figure 15. Self-Test Response (X and Y Axes) vs. Temperature

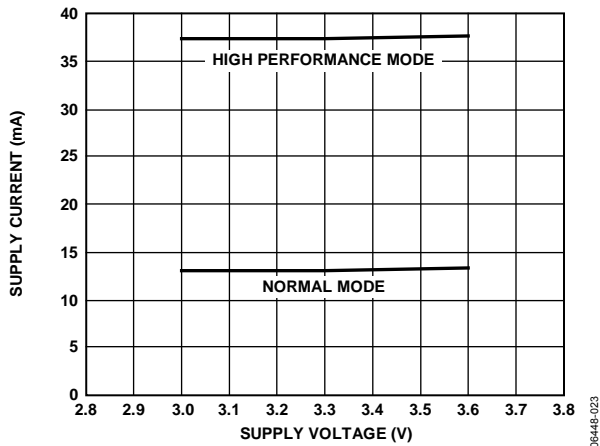

Figure 13. Supply Current vs. Supply Voltage

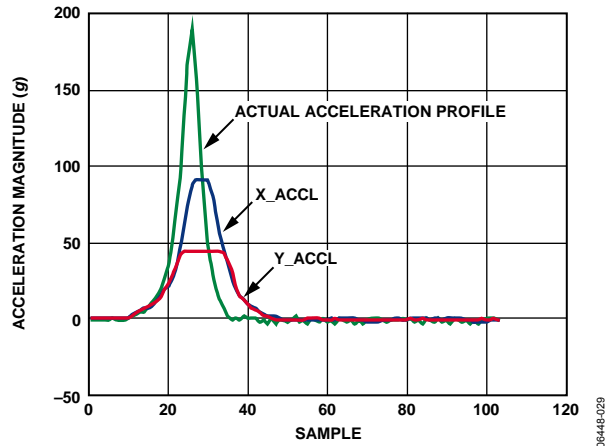

Figure 16. Overrange Recovery, Sample Rate = 4096 SPS

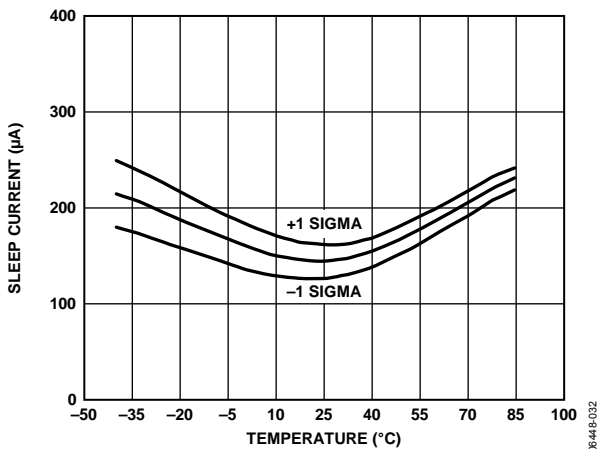

Figure 14. Sleep Current vs. Temperature

THEORY OF OPERATION

OVERVIEW

The ADIS16204 integrates a dual-axis $\pm 70\text{ g}/\pm 37\text{ g}$ MEMS acceleration sensor into a complete impact/shock measurement and recording system. The integrated mixed signal processing circuit digitizes the sensor data, applies corrections factors, provides many user-programmable features, and offers a simple communication conduit: the serial peripheral interface (SPI).

ACCELERATION SENSOR

The ADIS16204 base sensor core provides a fully differential sensor structure and circuit path, resulting in substantial rejection of electromagnetic interference (EMI) effects. It uses electrical feedback with zero-force feedback for improved accuracy and stability. The sensor's resonant frequency is well beyond the cut-off frequency of the filter, which adds further noise rejection to the sensor signal conditioning circuit.

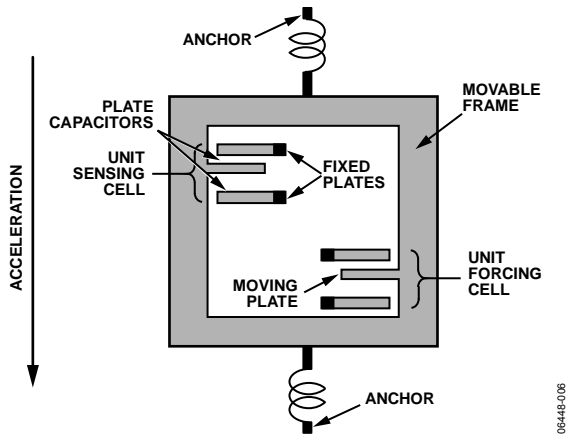

Figure 17. Simplified View of a Sensor Under Acceleration

Figure 17 is a simplified view of one of the differential sensor elements. Each sensor includes several differential capacitor unit cells. Each cell is composed of fixed plates attached to the substrate and movable plates attached to the frame. Displacement of the frame changes the differential capacitance, which is measured by the on-chip circuitry.

Complementary 200 kHz square waves drive the fixed plates. Electrical feedback adjusts the amplitudes of the square waves such that the ac signal on the moving plates is 0 V. The feedback signal is linearly proportional to the applied acceleration. This unique feedback technique ensures that there is no net electrostatic force applied to the sensor. The differential feedback control signal is also applied to the input of the filter, where it is filtered and converted to a single-ended signal.

TEMPERATURE SENSOR

This sensor reflects the sensor's junction temperature and provides a convenient temperature measurement for system-level characterization and calibration feedback.

IMPACT/SHOCK RESPONSE

The sensor's mechanical structure provides a linear measurement range that is 8 times that of each axis' actual output measurement range. Therefore, when considering the response to high-g, short duration events, the 2-pole, 400 Hz, low-pass Bessel filter network influences the output response. Figure 18 provides a frequency response for this signal chain. In Figure 19, the X-axis accelerometer experiences a 560 g shock event that lasts 0.1 ms, causing the output response to reach 70 g. For users that need to avoid output saturation, keeping the integration of the event's acceleration response (acceleration-time product in the case of Figure 19) below 56 g-ms is critical.

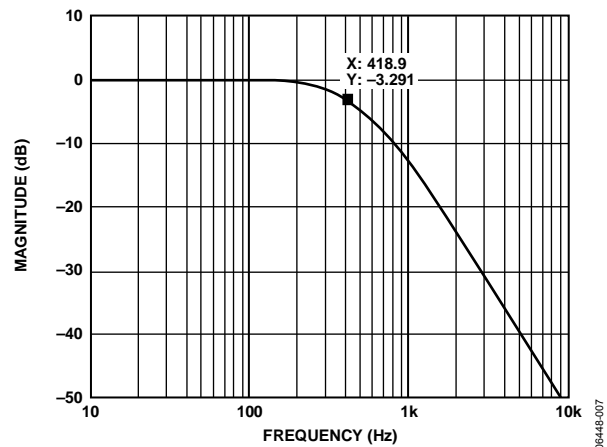

Figure 18. ADIS16204 Frequency Response

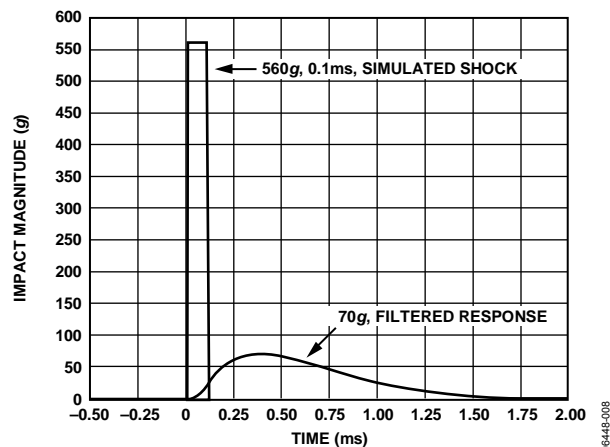

Figure 19. ADIS16204 Shock Response

AUXILIARY ADC FUNCTION

The auxiliary ADC function integrates a standard 12-bit ADC into the ADIS16204 to digitize other system-level analog signals. The output of the ADC can be monitored through the AUX_ADC control register, as defined in Table 6. The ADC is a 12-bit successive approximation converter. The output data is presented in straight binary format with the full-scale range extending from 0 V to V_{REF} . A high precision, low drift, factory calibrated 2.5 V reference is also provided.

Figure 20 shows the equivalent circuit of the analog input structure of the ADC. The input capacitor (C1) is typically 4 pF and can be attributed to parasitic package capacitance. The two diodes provide ESD protection for the analog input. Care must be taken to ensure that the analog input signals never exceed the supply rails by more than 300 mV. This causes the diodes to become forward-biased and to start conducting. The diodes can handle 10 mA without causing irreversible damage. The resistor is a lumped component that represents the on resistance of the switches. The value of this resistance is typically 100 Ω . Capacitor C2 represents the ADC sampling capacitor and is typically 16 pF.

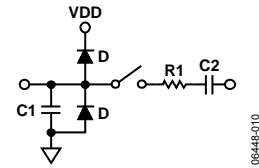

Figure 20. Equivalent Analog Input Circuit
Conversion Phase: Switch Open
Track Phase: Switch Closed

For ac applications, removing high frequency components from the analog input signal is recommended by the use of a low-pass filter on the analog input pin.

In applications where harmonic distortion and signal-to-noise ratio are critical, the analog input must be driven from a low impedance source. Large source impedances significantly affect the ac performance of the ADC. This can necessitate the use of an input buffer amplifier. When no input amplifier is used to drive the analog input, the source impedance should be limited to values lower than 1 k Ω .

BASIC OPERATION

The ADIS16204 is designed for simple integration into industrial system designs, requiring only a power supply and a 4-wire, industry-standard SPI. The SPI provides access to the ADIS16204's register structure, which controls access to all sensor output data and controls for the device's programmable features. Each register is 16 bits in length and has its own unique bit map. The 16 bits in each register consist of an upper byte (Bit 8 to Bit 15) and a lower byte (Bit 0 to Bit 7), each of which has its own 6-bit address.

SERIAL PERIPHERAL INTERFACE

The ADIS16204 SPI port includes four signals: chip select (\overline{CS}), serial clock (SCLK), data input (DIN), and data output (DOUT). The \overline{CS} line enables the ADIS16204 SPI port and frames each SPI event. When this signal is high, the DOUT lines are in a high impedance state and the signals on DIN and SCLK have no impact on operation. A complete data frame contains 16 clock cycles. Because the SPI port operates in full duplex mode, it supports simultaneous, 16-bit receive (DIN) and transmit (DOUT) functions during the same data frame.

See Table 2, Figure 2, and Figure 3 for detailed timing and operation of the SPI port.

Writing to Registers

Figure 21 displays a typical data frame for writing a command to a control register. In this case, the first bit of the DIN sequence is a 1, followed by a 0, the 6-bit address, and the 8-bit data command. Because each write command covers a single byte of data, two data frames are required when writing to the entire 16-bit space of a register. The DIN bits clock into the ADIS16204 on the rising edge of SCLK.

Reading from Registers

Reading the contents of a register requires a modification to the sequence in the DIN sequence shown in Figure 21. As shown in Figure 22, the first two bits in the DIN sequence are 0, followed by 6 address bits. Each register has two addresses (upper, lower), but either one can be used to access its entire 16 bits of data. The final 8 bits of the DIN sequence are irrelevant and can be counted as don't cares during a read command. During the next data frame, the DOUT sequence contains the register's 16-bit data. The ADIS16204 clocks out the first DOUT bit on the falling edge of the \overline{CS} line and clocks out the rest of the DOUT bits on the falling edges of the SCLK signal. Although a single read command requires two separate data frames, the full duplex mode minimizes this overhead, requiring only one extra data frame when continuously sampling.

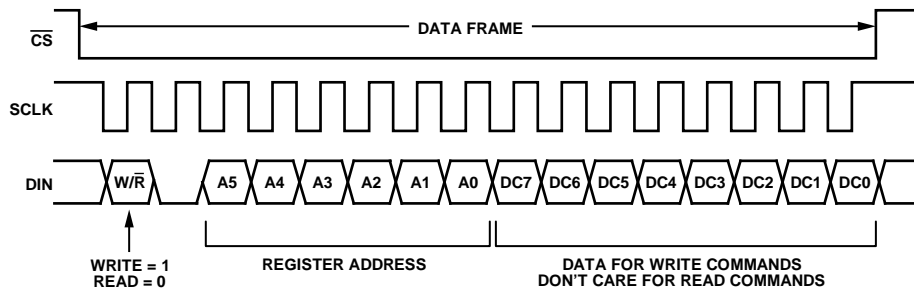

Figure 21. DIN Bit Sequence

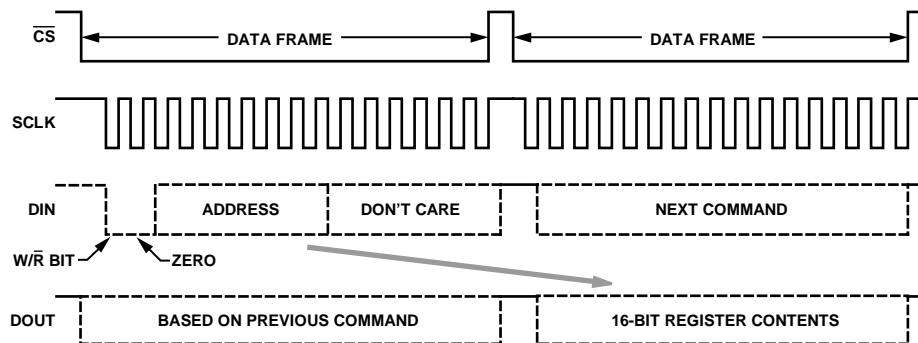

Figure 22. SPI Sequence for Read Commands

DATA OUTPUT REGISTER ACCESS

Table 6 provides an overview of each data output register, along with their function, address, and relevant decoding information.

Sensor Output Data

The ADIS16204 provides access to X- and Y-axis acceleration measurements, combined accelerations measurements (root sum square of X and Y), peak acceleration, power supply measurements, temperature measurements, an auxiliary 12-bit ADC channel, and the event-capture buffer memory.

Peak Sample-and-Hold Output Registers

The ADIS16204 monitors the X, Y and XY acceleration measurements and holds the maximum value and polarity for each parameter. The X_PEAK_OUT, Y_PEAK_OUT, and XY_PEAK_OUT registers provide access to these maximum values. See the COMMAND register for how to clear these registers.

Register Access

This output data is continuously updating internally, regardless of user read rates. The bit map in Table 5 describes the structure of

all output data registers in the ADIS16204. The upper byte is always first in register read sequences.

Table 5. Output Bit Assignments

MSB				LSB			
ND	EA	D13	D12	D11	D10	D9	D8
D7	D6	D5	D4	D3	D2	D1	D0

The MSB holds the new data (ND) indicator. When the output registers are updated with new data, the ND bit goes to a 1 state. After the output data is read, it returns to a 0 state. The error/ alarm bit (EA) is used to indicate a system error or an alarm condition that can result from a number of conditions, such as a power supply that is out of the specified operating range (see the Status and Diagnostics section for more details). The output data is either 12 bits or 14 bits in length. For all of the 12-bit output data, Bit D13 and Bit D12 are assigned don't care status.

The output data register map located in Table 6 provides all of the necessary details for accessing each register's data. Figure 23 provides an example of the SPI sequence.

Table 6. Data Output Register Information

Name	Function	Register	Resolution (Bits)	Data Format	Scale Factor (per LSB)
SUPPLY_OUT	Power supply	0x03, 0x02	12	Binary	1.22 mV
XACCL_OUT	X-axis acceleration	0x05, 0x04	14	Twos complement	17.125 mg
YACCL_OUT	Y-axis acceleration	0x07, 0x06	14	Twos complement	8.407 mg
AUX_ADC	Auxiliary analog input data	0x09, 0x08	12	Binary	0.61 mV
TEMP_OUT ¹	Sensor temperature data	0x0B, 0x0A	12	Binary	-0.47°C
X_PEAK_OUT ²	Peak, X-axis acceleration	0x0D, 0x0C	14	Twos complement	17.125 mg
Y_PEAK_OUT ²	Peak, Y-axis acceleration	0x0F, 0x0E	14	Twos complement	8.407 mg
XY_RSS_OUT ³	XY combined acceleration (RSS)	0x19, 0x18	14	Binary	17.125 mg
XY_PEAK_OUT ^{2,3}	Peak, XY combined output (RSS)	0x1B, 0x1A	14	Binary	17.125 mg
CAPT_BUF_1 ⁴	Capture Buffer 1 Output Register	0x1D, 0x1C	See the Alarm Detection and Event Capture section, Table 37, and Table 38		
CAPT_BUF_2 ⁴	Capture Buffer 2 Output Register	0x1F, 0x1E			

¹ 25°C, nominal output is equal to 1278 LSB.

² The peak levels in these registers accumulate, storing the greatest value measured (polarity is captured—except for XY_PEAK_OUT), until they are cleared using the COMMAND register.

³ This is a measure of the total shock absorbed by the package in the XY plane, and is the result of a root sum square of X and Y acceleration measurements.

⁴ See the Alarm Detection and Event Capture section for more details.

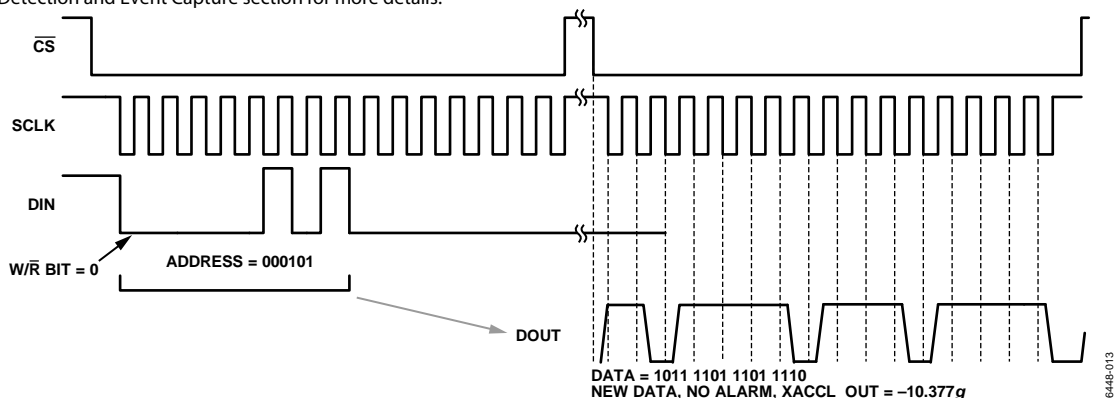

Figure 23. Example of an Output Timing/Coding Diagram

PROGRAMMING AND CONTROL

CONTROL REGISTER OVERVIEW

The ADIS16204 offers many programmable features controlled by writing commands to the appropriate control registers. The following features are available for configuration:

- Global commands
- Calibration
- Operational control
 - Sample rate
 - Power management
 - DAC output
 - Digital I/O
- Operational status and diagnostics
 - Self-test
 - Status conditions
 - Alarms
- Event capture

CONTROL REGISTER STRUCTURE

The ADIS16204 uses a temporary, SRAM-based memory structure to facilitate the control registers displayed in Table 7. The start-up configuration is stored in a flash memory structure that automatically loads into the control registers during the start-up sequence. Each nonvolatile register has a corresponding flash memory location for storing the latest configuration contents. Because flash memory has endurance limitations, the contents of each nonvolatile register must be stored to flash manually. Note that the contents of the control register are only nonvolatile when they are stored to flash. The flash update command, made available in the COMMAND register, provides this function. The ENDURANCE register provides a counter, which allows for memory reliability management against the flash memory's write cycle specification.

Table 7. Control Register Mapping

Name	Type	Volatility ¹	Address	Bytes	Function	Reference Table
ENDURANCE	R	Nonvolatile	0x01, 0x00	2	Flash memory write counter	Table 26
			0x02 to 0x0F	14	Output data registers	Table 6
XACCL_NULL	R/W	Nonvolatile	0x11, 0x10	2	X-axis offset null calibration register	Table 10
YACCL_NULL	R/W	Nonvolatile	0x13, 0x12	2	Y-axis offset null calibration register	Table 11
XACCL_SCALE	R/W	Nonvolatile	0x15, 0x14	2	X-axis scale factor calibration register	Table 12
YACCL_SCALE	R/W	Nonvolatile	0x17, 0x16	2	Y-axis scale factor calibration register	Table 13
			0x18 to to 0x1B	4	Output data registers	Table 6
CAP_BUF_1	R	Volatile	0x1D, 0x1C	2	Capture buffer output register 1	Table 37, Table 38
CAP_BUF_2	R	Volatile	0x1F, 0x1E	2	Capture buffer output register 2	Table 37, Table 38
ALM_MAG1	R/W	Nonvolatile	0x21, 0x20	2	Alarm 1 amplitude threshold	Table 32, Table 34
ALM_MAG2	R/W	Nonvolatile	0x23, 0x22	2	Alarm 2 amplitude threshold	Table 33, Table 34
			0x24 to 0x27	2	Reserved	
ALM_CTRL	R/W	Nonvolatile	0x29, 0x28	2	Alarm source control register	Table 30, Table 31
CAPT_PNTR	R/W	Volatile	0x2B, 0x2A	2	Capture register address pointer	Table 39, Table 40
			0x2A to 0x2F	6	Reserved	
AUX_DAC	R/W	Volatile	0x31, 0x30	2	Auxiliary DAC data	Table 19, Table 20
GPIO_CTRL	R/W	Volatile	0x33, 0x32	2	Auxiliary digital I/O control register	Table 21, Table 22
MSC_CTRL	R/W	Nonvolatile ²	0x35, 0x34	2	Miscellaneous control register	Table 24, Table 25
SMPL_PRD	R/W	Nonvolatile	0x37, 0x36	2	ADC sample period control register	Table 15, Table 16
CAPT_CFG	R/W	Nonvolatile	0x39, 0x38	2	Capture configuration register	Table 35, Table 36
SLP_CNT	W	Volatile	0x3B, 0x3A	2	Counter used to determine length of power-down mode	Table 17, Table 18
STATUS	R	Volatile	0x3D, 0x3C	2	System status register	Table 27, Table 28
COMMAND	W	N/A	0x3F, 0x3E	2	System command register	Table 8, Table 9

¹ In order to establish nonvolatile status, the flash memory must be updated after updating the control registers.

² Bit 8 clears after the internal self-test sequence completes, effectively making this bit volatile.

GLOBAL COMMANDS

The ADIS16204 provides global commands, which simplify many common operations. The COMMAND register provides command bits for each function. Writing a 1 to the assigned command bit exercises its function. The flash update copies the contents of all nonvolatile registers into their assigned, nonvolatile, flash memory locations. This process takes approximately 50 ms and requires a power supply that is within the specified operating range. After waiting the appropriate time for the flash update to complete, verify successful completion by reading the STATUS register (flash update error = zero, if successful). If the flash update was not successful, reading this error bit accomplishes two things: (1) alert system processor to try again, and (2) clear the error flag, which is required for flash memory access.

The software reset command restarts the internal processor, which loads all registers with the contents in their flash memory locations. The DAC data latch command loads the contents of AUX_DAC into the DAC latches. Because the AUX_DAC contents must be updated one byte at a time, this command ensures a stable DAC output voltage during updates.

Calibration Commands

The autonull command provides a simple method for removing offset from the sensor outputs. This command takes separate 64-sample measurements for each axis (X, Y), then loads the opposite value into each axis' offset null register. The accuracy of this operation depends on zero force or motion during the 64-sample timeframe. The factory calibration restore sets the scale and offset null registers (XACCL_NULL, for example) back to their default values. For more information on ADIS16204 calibration, see the Calibration section.

Event Capture Commands

The COMMAND register provides four different functions that simplify the process of using the event capture function. The reset-capture pointer function sets the contents of the capture pointer to its initial value of 0x0001. The clear capture flash, clear capture buffer, and capture flash copy commands are self-descriptive. The capture flash copy takes approximately 120 ms to complete and serves the purpose of copying the capture buffer into nonvolatile flash memory. See the Alarm Detection and Event Capture section for more information.

Table 8. COMMAND Register Definition

Address	Default	Format	Access
0x3F, 0x3E	N/A	N/A	W only

Table 9. COMMAND Bit Descriptions

Bit	Description
15:11	Not used
10	Reset-capture pointer (set CAPT_PNTR to 0x0001)
9	Clear capture flash (nonvolatile back-up)
8	Clear capture buffer (SRAM)
7	Software reset
6	Copy capture buffer to nonvolatile flash
5	Clear peak output registers, (reset them to 0x0000)
4	Clear status register (reset all bits to 0)
3	Flash update—saves nonvolatile register settings
2	DAC data latch
1	Factory calibration restore
0	Autonull

CALIBRATION

In addition to the factory calibration, the ADIS16204 provides a user configurable calibration for systems that require accuracy improvements. For example, a vehicle system may require better resolution to separate a minor bump from a hard brake event. In cases like this, the ADIS16204 provides configuration registers that adjust both offset and sensitivity (gain) on both X- and Y-axes. The following relationship describes the calibration function:

$$y = mx + b$$

where:

y is the calibrated output data.

m is the scale factor multiplier [XACCL_SCALE/YACCL_SCALE].

x is the precalibration data.

b is the offset adder [XACCL_NULL/YACCL_NULL].

Assuming zero offset and nominal scale factor (sensitivity), the offset adjustment range for the X-axis is $\pm 35.054 g$ and $\pm 17.527 g$ for the Y-axis. Assuming zero offset, the scale factor adjustment range is 0 to 2.

Table 10. XACCL_NULL Register Definition

Address	Scale ¹	Default	Format	Access
0x11, 0x10	17.125 mg	0x0000	Twos complement	R/W

¹ Scale is the weight of each LSB.

Table 11. YACCL_NULL Register Definition

Address	Scale ¹	Default	Format	Access
0x13, 0x12	8.407 mg	0x0000	Twos complement	R/W

¹ Scale is the weight of each LSB.

Table 12. XACCL_SCALE Register Definition

Address	Scale ¹	Default ²	Format	Access
0x15, 0x14	0.0488%	0x0800	Binary	R/W

¹ Scale is the weight of each LSB.

² Equates to a scale factor of one.

ADIS16204

Table 13. YACCL_SCALE Register Definition

Address	Scale ¹	Default ²	Format	Access
0x17, 0x16	0.0488%	0x0800	Binary	R/W

¹ Scale is the weight of each LSB.
² Equates to a scale factor of one.

Table 14. Calibration Register Bit Descriptions

Bit	Description
15:12	Not used
11:0	Data bits

OPERATIONAL CONTROL

Internal Sample Rate

The internal sample rate defines how often data output variables are updated, independent of the rate at which they are read out on the SPI port. The SMPL_PRD register controls the ADIS16204 internal sample rate and has two parts: a selectable time base and a multiplier. The following relationship produces the sample rate:

$$T_s = T_B \times (N_s + 1)$$

where:

T_s is the sample period.

T_B is the time base.

N_s is the increment setting.

The default value is the maximum 4096 SPS, and the contents of this register are nonvolatile.

Table 15. SMPL_PRD Register Definition

Address	Default	Format	Access
0x37, 0x36	0x0001	N/A	R/W

Table 16. SMPL_PRD Bit Descriptions

Bit	Description
15:8	Not used
7	Time base 0 = 122.07 μ s, 1 = 3.784 ms
6:0	Multiplier

Here is an example calculation of the sample period for the ADIS16204:

$$\text{If } SMPL_PRD = 0x0007, B7 - B0 = 00000111$$

$$B7 = 0 \rightarrow T_B = 122.07 \mu\text{s}$$

$$B6 \dots B0 = 00000111 \rightarrow N_s = 7$$

$$T_s = T_B \times (N_s + 1) = 122.07 \mu\text{s} \times (7 + 1) = 976.56 \mu\text{s}$$

$$f_s = 1/T_s = 1024 \text{ SPS}$$

The sample rate setting has a direct impact on the SPI data rate capability. For sample rates ≥ 1024 SPS, the SPI SCLK can run at a rate up to 2.5 MHz. For sample rates < 1024 SPS, the SPI SCLK can run at a rate up to 1 MHz.

The sample rate setting also affects the power dissipation. When the sample rate is set below 1024 SPS, the power dissipation typically reduces by a factor of 68%. The two different modes of operation offer a system-level trade-off between performance (sample rate, serial transfer rate) and power dissipation.

Power Management

In addition to offering two different performance modes for power optimization, the ADIS16204 offers a programmable shutdown period. Writing the appropriate sleep time to the SLP_CNT register shuts the device down for the specified time. The following example provides an illustration of this relationship:

$$B7 \dots B0 = 00000110$$

$$\text{Sleep period} = 3 \text{ seconds}$$

After completing the sleep period, the ADIS16204 returns to normal operation.

Table 17. SLP_CNT Register Definition

Address	Scale ¹	Default	Format	Access
0x3B, 0x3A	0.5 sec	0x0000	Binary	W only

¹ Scale is the weight of each LSB.

Table 18. SLP_CNT Bit Descriptions

Bit	Description
15:8	Not used
7:0	Data bits

Auxiliary DAC

The auxiliary DAC provides a 12-bit level adjustment function. The AUX_DAC register controls the operation of this feature. It offers a rail-to-rail buffered output that has a range of 0 V to 2.5 V. The DAC can drive its output to within 5 mV of the ground reference when it is not sinking current. As the output approaches ground, the linearity begins to degrade (100 LSB beginning point). As the sink current increases, the nonlinear range increases. The DAC output latch function, contained in the COMMAND register, provides continuous operation while writing to each byte of this register. The contents of this register are volatile, which means that the desired output level must be set after every reset and power cycle event.

Table 19. AUX_DAC Register Definition

Address	Scale ¹	Default	Format	Access
0x31, 0x30	0.6105 mV	0x0000	Binary	R/W

¹ Scale is the weight of each LSB. In this case, it represents 4095 codes over the 2.5 V range out of output voltage.

Table 20. AUX_DAC Bit Descriptions

Bit	Description
15:12	Not used
11:0	Data bits

General-Purpose I/O

The ADIS16204 provides two general-purpose pins that enable digital I/O control using the SPI. The GPIO_CTRL control register establishes the configuration of these pins and handles the SPI-to-pin controls. Each pin provides the flexibility of both input (read) and output (write) operations. For example, writing a 0x0202 to this register establishes Line 1 as an input and Line 2 as an output that is in a 1 state. Writing 0x0000 to this register establishes both lines as inputs. When one (or both) of these lines is configured as an input, reading the assigned bit (Bit 8 and/or Bit 9) provides access to the input on this input pin.

The digital I/O lines are also available for data-ready and alarm/error indications. In the event of conflict, the following priority structure governs the digital I/O configuration:

1. GPIO_CTRL
2. MSC_CTRL
3. ALM_CTRL

Table 21. GPIO_CTRL Register Definition

Address	Default	Format	Access
0x33, 0x32	0x0000	N/A	R/W

Table 22. GPIO_CTRL Bit Descriptions

Bit	Description
15:10	Not used
9	General-purpose I/O Line 2 polarity 1 = high, 0 = low
8	General-purpose I/O Line 1 polarity 1 = high, 0 = low
7:2	Not used
1	General-purpose I/O Line 2, data direction control 1 = output, 0 = input
0	General-purpose I/O Line 1, data direction control 1 = output, 0 = input

STATUS AND DIAGNOSTICS

The ADIS16204 provides a number of status and diagnostic functions. Table 23 provides a summary of these functions, along with their appropriate control registers.

Table 23. Status and Diagnostic Functions

Function	Register
Data-ready I/O indicator	MSC_CTRL
Self-test, mechanical check for MEMS sensor	MSC_CTRL
Software check for error conditions	STATUS
Flash memory endurance	ENDURANCE

Data-Ready I/O Indicator

The data-ready function provides an indication of new output data. The MSC_CTRL register provides the opportunity to configure either of the general-purpose I/O pins (DIO1 and DIO2)

as a data-ready indicator signal. When configured as a data ready indicator, the duty cycle is 20% ($\pm 10\%$ tolerance).

Self-Test

The MSC_CTRL register also provides a self-test function that verifies the mechanical integrity of the MEMS sensor. A self-test exercises the mechanical structure and signal conditioning circuit: from sensor element to data out. The internal test provides a simple, two-step process for checking the MEMS sensor: (1) start the process by writing a 1 to Bit 8 in the MSC_CTRL register, (2) wait 35 ms, and (3) check the result by reading Bit 5 of the STATUS register.

The device is configured to perform a self-test at power on. Writing a 1 to Bit 10 of the MSC_CTRL register disables this function for future start-up sequences, reducing the start-up time. For reference, the result of the electrostatic deflection of each axis is available by reading the XACCL_OUT and/or YACCL_OUT registers. As an additional indicator of self-test, the new data bit is not active while in this mode.

Table 24. MSC_CTRL Register Definition

Address	Default	Format	Access
0x35, 0x34	0x0000	N/A	R/W

Table 25. MSC_CTRL Bit Descriptions

Bit	Description
15:12	Not used
11	Store capture to flash after capture buffer fills up 1 = enabled, 0 = disabled
10	Self-test at power-on 1 = disabled, 0 = enabled
9	Not used
8	Self-test enable (temporary, bit is volatile) 1 = enabled, 0 = disabled
7:3	Not used
2	Data-ready enable 1 = enabled, 0 = disabled
1	Data-ready polarity 1 = active high, 0 = active low
0	Data-ready line select 1 = DIO2, 0 = DIO1

Flash Memory Endurance

The ENDURANCE register maintains a running count of writes to the flash memory. This provides a convenient tool for managing the reliability of the on-chip memory. Once it reaches its maximum value of 32,767, it wraps around to zero and starts over.

Table 26. ENDURANCE Register Definition

Address	Default	Format	Access
0x01, 0x00	N/A	Binary	R only

STATUS Conditions

The STATUS register contains the following error-condition flags: alarm conditions, self-test status, SPI communication failure, capture buffer full, control register update failure, and power supply out of range. See Table 27 and Table 28 for the appropriate register access and bit assignment for each flag. The bits assigned for checking power supply range automatically reset to zero when the error condition no longer exists. Clearing the remaining error-flag bits requires a single write command to the COMMAND register (write a 1 to Bit 4). See Table 8 and Table 9 for the configuration details of the COMMAND register. If the error condition still exists after exercising the COMMAND register to clear the bits, the appropriate error flag bit returns to 1 during the next sampling cycle. All bits in the STATUS register are volatile.

Table 27. STATUS Register Definition

Address	Default	Format	Access
0x3D, 0x3C	0x0000	N/A	R only

Table 28. STATUS Bit Descriptions

Bit	Description
15:13	Not used
12	Capture buffers full
11:10	Not used
9	Alarm 2 status 1 = active, 0 = inactive
8	Alarm 1 status 1 = active, 0 = inactive
7:6	Not used
5	Self-test diagnostic error flag 1 = error condition, 0 = normal operation
4	Not used
3	SPI communications failure 1 = error condition, 0 = normal operation
2	Flash update failed 1 = error condition, 0 = normal operation
1	Power supply above 3.625 V 1 = > 3.625 V, 0 = < 2.975 V (normal)
0	Power supply below 2.975 V 1 = < 2.975 V, 0 = > 2.975 V (normal)

ALARM DETECTION AND EVENT CAPTURE

The ADIS16204 provides alarm detection and event capture functions, which monitor critical internal and external operating conditions. Six factory standard alarms monitor the ADIS16204 for normal operation. Two programmable alarms provide monitoring for system-critical conditions,

which reduces the external processing burden for this function. Alarm monitoring includes both software (STATUS register) and hardware options (DIO1 and DIO2 configuration, ALM_CTRL register). In addition, the programmable alarms can trigger an event capture function, which provides time recording, much like a single event capture function on a digital oscilloscope. Table 29 provides a summary of the functions available for configuring the alarms.

Alarm Configuration

1. Program the Output Data to Monitor.

Essentially, this establishes the trigger source, by configuring the upper byte of the ALM_CTRL register. See Table 31 for the proper bit assignments. For example, the following pseudo code establishes X acceleration as the trigger for Alarm 2 and Y acceleration as the trigger for Alarm 1:

- Write 0x23 to Address 0x29 [ALM_CTRL].

2. Program the Trigger Levels and Polarity.

This requires two write commands for each alarm, to the ALM_MAG1 and ALM_MAG2 registers. For example, use the following pseudo code to establish greater than 7.4 g as the trigger threshold for both channels:

- Write 0x81 to Address 0x21 [ALM_MAG1].
- Write 0xB0 to Address 0x20 [ALM_MAG1].
- Write 0x83 to Address 0x23 [ALM_MAG2].
- Write 0x70 to Address 0x22 [ALM_MAG2].

The ALM_MAG1 and ALM_MAG2 values are calculated by:

$$X = 7.4 g = 432 \text{ codes} = 00 \ 0001 \ 1011 \ 0000 \ (\text{Bit } 0 \text{ to Bit } 13)$$

$$Y = 7.4 g = 880 \text{ codes} = 00 \ 0011 \ 0111 \ 0000 \ (\text{Bit } 0 \text{ to Bit } 13)$$

Bit 15 in both registers must be set to 1 in order to denote greater than polarity.

3. Set Up a Digital I/O Line as an Alarm Indicator.

This step requires configuration of the lower byte in the ALM_CTRL. If software monitoring, using the STATUS register, is the preferred alarm-checking method, then this step is not required. The following pseudocode establishes Digital I/O Line 2 as a positive signal, alarm indicator:

- Write 0x07 to Address 0x28 [ALM_CTRL].

See Table 31 for the configuration options available for this function. As noted earlier, the digital I/O lines are shared, so use of them as an alarm indicator requires that it not be in use as a data-ready or general-purpose I/O pin.

Table 29. Alarm and Event Capture Configuration Registers

Register	Parameter/Function	Default Setting
ALM_CTRL	Alarm trigger source	None
ALM_CTRL	Capture buffer triggers	Disabled
ALM_CTRL	Digital alarm output	Disabled
ALM_MAG1/ ALM_MAG 2	Alarm trigger levels	0
ALM_MAG1/ ALM_MAG 2	Alarm trigger directions	Less than
CAPT_CFG	Capture data sources	1: X acceleration 2: Y acceleration
CAPT_CFG	Capture buffer size	1024 samples
CAPT_CFG	Pretrigger data size	128 samples
COMMAND	Reset capture pointer	N/A
COMMAND	Clear capture buffer	N/A
COMMAND	Clear capture flash	N/A
COMMAND	Clear buffer full flag	N/A
COMMAND	Save captured data to nonvolatile flash	N/A
MSC_CTRL	Autosave captured data to nonvolatile flash	Disabled
SMPL_PRD	Sample rate	4096 SPS

Table 30. ALM_CTRL Register Definition

Address	Default	Format	Access
0x29, 0x28	0x0000	N/A	R/W

Table 31. ALM_CTRL Bit Descriptions

Bit	Value	Description
15:12		Trigger source selection, Alarm 2
	0000	Disable
	0001	Power supply
	0010	X-acceleration
	0011	Y-acceleration
	0100	Auxiliary ADC
	0101	Temperature sensor
	1000	XY RSS acceleration
11:8		Trigger source selection, Alarm 1 (See Alarm2)
7		Not used
6		Capture trigger activation, Alarm 2 1 = enabled, 0 = disabled
5		Not used
4		Capture trigger activation, Alarm 1 1 = enabled, 0 = disabled
3		Not used
2		Alarm indicator, using DIO1/2 1 = enabled, 0 = disabled
1		Alarm indicator polarity 1 = active high, 0 = active low
0		Alarm indicator line selection 1 = DIO2, 0 = DIO1

Table 32. ALM_MAG1 Register Definition

Address	Default	Format	Access
0x21, 0x20	0x0000	N/A	R/W

Table 33. ALM_MAG2 Register Definition

Address	Default	Format	Access
0x23, 0x22	0x0000	N/A	R/W

Table 34. ALM_MAG1/ALM_MAG 2 Bit Designations

Bit	Description
15	Comparison polarity 1 = greater than, 0 = less than
14	Not used
13:0	Data bits: format matches source data format (see Table 5 and Table 6)

Event Capture Overview

The ADIS16204 also provides a dual-channel, capture function. Figure 24 provides an example of a captured waveform. A dedicated set of programmable control registers govern the operation of this function, controlling the data source: trigger settings (level, direction, and data source), memory depth, pretrigger data length, and data storage. In systems that require specific event monitoring, this feature simplifies system integration by reducing the burden on the system's processor. One convenient feature is the fact that the trigger source does not have to be the data that is captured.

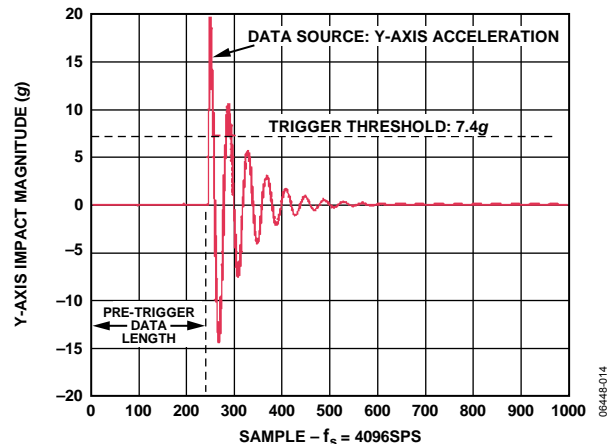

Figure 24. Event Capture Example

Event Capture Configuration

The event capture buffers use the alarms as their trigger source. Therefore, the first two configuration steps are the same. After setting the trigger data source(s) and threshold(s), follow Step 1 through Step 5 to complete the event capture setup.

1. Program the Data Source to Capture.

This requires a single write cycle, to configure the upper byte of the CAPT_CFG register. For example, use the following pseudo code to set X acceleration and Y acceleration as the data sources for Capture Buffer 2 and Capture Buffer 1 respectively:

- Write 0x23 to Address 0x39 [CAPT_CFG].

ADIS16204

2. Configure the Capture Backup Memory.

Setting Bit 11 of the MSC_CTRL register to a 1 enables the event capture back-up function, effectively making it nonvolatile. When enabled, this function copies the contents of the capture buffer (right after it fills) to flash memory and restores it upon reset or powering the device on. It continues to do so until the buffer is cleared, using the COMMAND register. To enable this feature, use the following pseudo code:

- Write 0x08 to Address 0x35 [MSC_CTRL].

3. Clear the Capture Memory Locations.

Use the following pseudo code to clear both the normal capture locations (SRAM) and their respective flash memory locations:

- Write 0x03 to Address 0x3F [COMMAND].

4. Set Up a Digital I/O Line as an Alarm Indicator.

5. Set Each Alarm as a Trigger Source for the Buffer.

These steps require configuration of the lower byte in the ALM_CTRL register. The following pseudo code establishes Digital I/O Line 2 as a positive signal, alarm indicator, if necessary. It also arms both triggers for the event recorder.

- Write 0x57 to Address 0x28 [ALM_CTRL].

If a digital alarm indicator function were not required, the pseudo code would be:

- Write 0x50 to Address 0x28 [ALM_CTRL].

Table 35. CAPT_CFG Register Definition

Address	Scale	Default	Format	Access
0x39, 0x38	N/A	0x327A	N/A	R/W

Table 36. CAPT_CFG Bit Descriptions

Bit	Description
15:12	Data source for Capture Buffer 2 0001= power supply 0010= X-axis acceleration 0011= Y-axis acceleration 0100= auxiliary ADC 0101= temperature sensor 1000= XY RSS acceleration
11:8	Data source for Capture Buffer 1 (See Capture Buffer 2 for binary coding)
7:4	Pretrigger length Power of two setting determines length. 0111b = 7d, which corresponds to $2^7 = 128$ samples. If this setting is greater than the data length, its value is truncated and all captured samples are prior to the trigger
3:0	Capture buffer length Power of two setting determine length. 1010b = 10d, which corresponds to $2^{10} = 1024$ samples. The lowest setting is a 3, which corresponds to 8 samples

Event Capture Data Access

Two output registers provide the necessary access for the ADIS16204's capture buffers: CAPT_BUF_1 and CAPT_BUF_2. At the completion of a capture event, the contents of these registers contain the first sample from each buffer. Figure 25 provides a diagram that displays the role played by the CAPT_PNTR register in this process. This register provides a pointer function and automatically increments every time one of the CAP_BUF_x registers are read. If efficient data transfer rates are a primary goal, then read all of the contents of one buffer, before moving to the other buffer. Because the CAPT_PNTR offers both read and write access, individual buffer locations can be accessed by writing the sample number into this register.

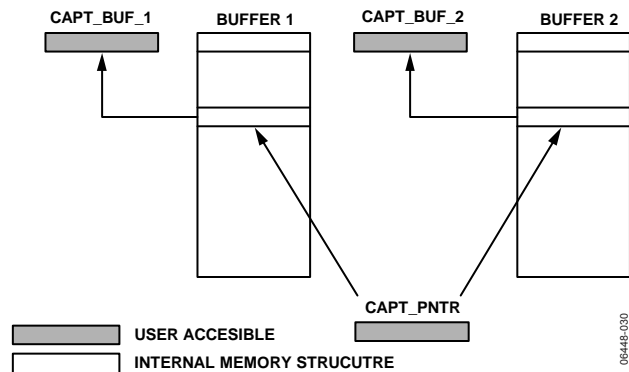

Figure 25. Event Capture Buffer Memory Structure

Table 37. Capture Register Definitions

Address	Address	Format	Access
CAPT_BUF_1	0x1D, 0x1C	The format and scale match that of the output data being monitored	R only
CAPT_BUF_2	0x1E, 0x1F		

Table 38. CAPT_BUF_1 and CAPT_BUF_2 Bit Descriptions

Bit	Description
15	Not used
14	Error/alarm condition (use to identify transition between pre-trigger and post-trigger data)
13:0	Data bits. Format matches that of the data source

Table 39. CAPT_PNTR Register Definition

Address	Scale	Default	Format	Access
0x2B, 0x2A	N/A	N/A	Binary	R/W

Table 40. CAPT_PNTR Bit Descriptions

Bit	Description
15:11	Not used
10:0	Capture address pointer: A binary number from 1 to 1024, which identifies the address of each individual capture buffer sample.

SECOND-LEVEL ASSEMBLY

The ADIS16204 can be attached to the second-level assembly board using Sn63 (or equivalent) or a Pb-free solder. Figure 26 and Table 41 provide acceptable solder reflow profiles for each solder type. Note that these profiles may not be the optimum profile for the user's application. In no case should 260°C be exceeded. It is recommended that the user develop a reflow profile based upon the specific application.

In general, keep in mind that the lowest peak temperature and shortest dwell time above the melt temperature of the solder results in less shock and stress to the product. In addition, evaluating the cooling rate and peak temperature can result in a more reliable assembly.

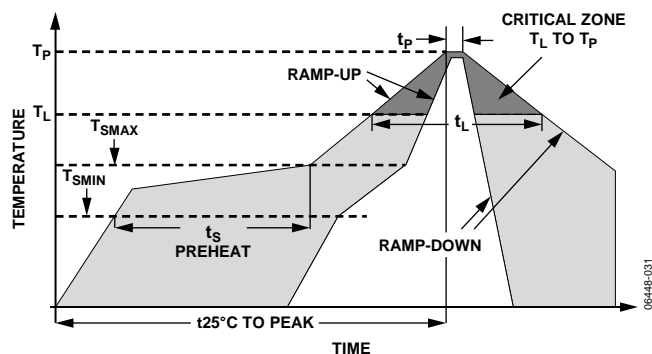

Figure 26. Acceptable Solder Reflow Profiles

Table 41. Acceptable Solder Reflow Profiles¹

Profile Feature	Condition	
	Sn63/Pb37	Pb-Free
Average Ramp Rate (T_L to T_P)	3°C/sec max	3°C/sec max
Preheat		
Minimum Temperature (T_{SMIN})	100°C	150°C
Maximum Temperature (T_{SMAX})	150°C	200°C
Time (T_{SMIN} to T_{SMAX}) (t_s)	60 sec to 120 sec	60 sec to 180 sec
T_{SMAX} to T_L		
Ramp-Up Rate	3°C/sec	3°C/sec
Time Maintained Above Liquidous Temperature (T_L)		
Liquidous Temperature (T_L)	183°C	217°C
Time (t_L)	60 sec to 150 sec	60 sec to 150 sec
Peak Temperature (T_P)	240°C + 0°C/-5°C	260°C + 0°C/-5°C
Time Within 5°C of Actual T_P	10 sec to 30 sec	20 sec to 40 sec
Ramp-Down Rate	6°C/sec max	6°C/sec max
Time 25°C to T_P	6 min max	8 min max

¹ Per IPC/JEDEC J-STD-020C.

ADIS16204

OUTLINE DIMENSIONS

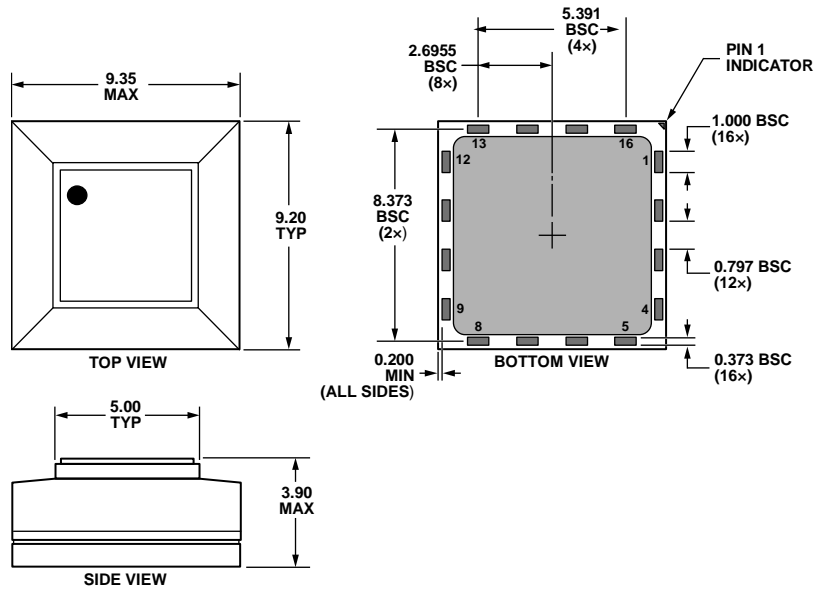

Figure 27. 20-Terminal Land Grid Array [LGA]
(CC-16-2)

Dimensions shown in millimeters

02/2017-B

ORDERING GUIDE

Model	Temperature Range	Package Description	Package Option
ADIS16204BCCZ ¹	-40°C to +105°C	16-Terminal Land Grid Array [LGA]	CC-16-2
ADIS16204/PCBZ ¹		Evaluation Board	

¹ Z = RoHS Compliant Part.

NOTES

ADIS16204

NOTES