

FILTERING

FLAT CABLE FERRITES

Features

- Employ high-performance ferrites (Nickel-Zinc) effective against high frequency noise.
- Special mounting options include adhesive tape, or screw type through holes available.
- Designed to help reduce cost and time to market saving.
- Can be installed in its intended location before or after product assembly simply with Mounting part.

Applications

- Superior suppression of radiation emissions for full compliance with FCC, VDE and VCCI on Interface/data line ribbon cables of computers, peripheral/terminal equipment.

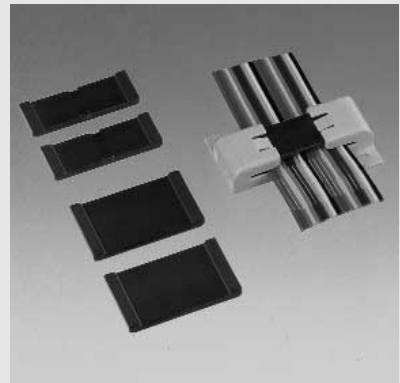
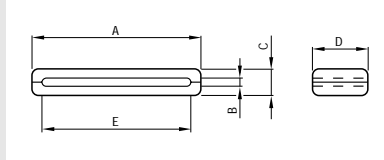

Part No.	A	B	Unit: mm			Impedance (Ω)		Max. Cable Width (mm)
			C	D	E	25MHz	100MHz	
SSH-33.5-12	33.5	1.2	6.6	12	27	33	63	26
SSH-33.5-20	33.5	1.2	6.6	20	27	52	92	26
SSH-40-12	40.0	1.2	6.6	12	35	27	61	34
SSH-45-12	45.0	1.2	6.6	12	40	25	60	39

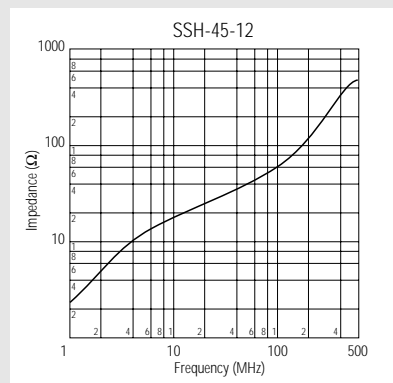
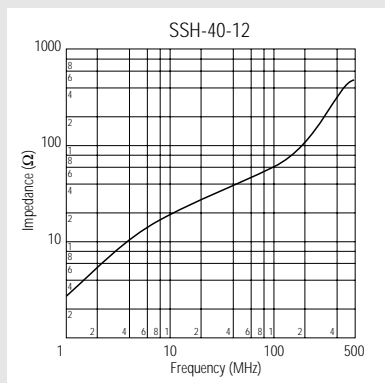
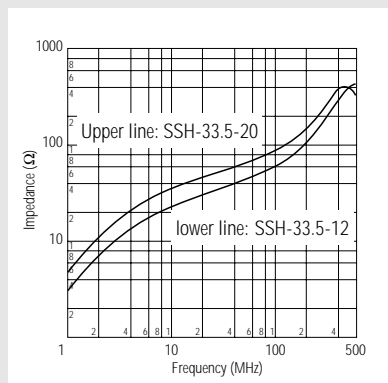

Mounting Parts for SSH type cores + SSC type cores

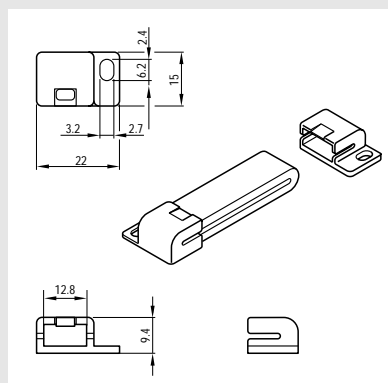

Part No.: FRH-12
Material: PA66 UL94V-0

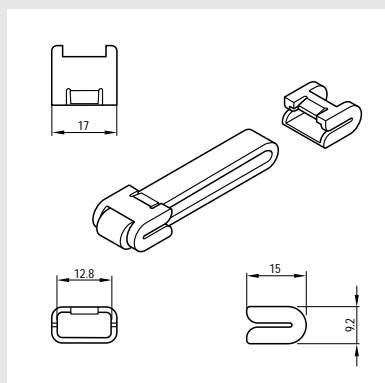

Part No.: FRC-12CP
Material: PA66 UL94V-0

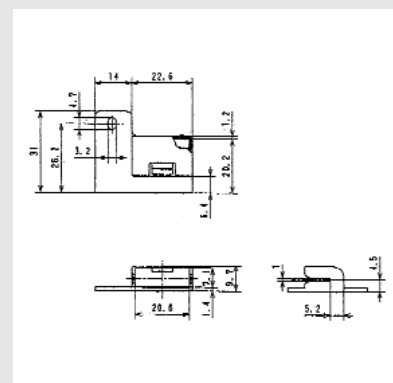

Part No.: FRHL-20
Material: PA66 UL94V-2

Part No.	
FRH-12	Mounting part for screw ($D \geq 12\text{mm}$)
FRHL-20	Mounting part for screw ($D \geq 20\text{mm}$)
FRC-12CP	Mounting part

KE KITAGAWA

Elbinger Straße 3-5 · D-63110 Rodgau-Jügesheim · Germany · Telefon 0 61 06/85 24 - 0 · Telefax 0 61 06/85 24-30 (31)

Features

- Employ high-performance ferrites (Nickel-Zinc) effective against high frequency noise.
- Designed to help reduce cost and time to market saving.
- Can be installed in its intended location before or after product assembly.

Application

- Superior suppression of radiation emissions for full compliance with FCC, VDE and VCCI on Interface/ data line ribbon cables of computers, peripheral/terminal equipment.

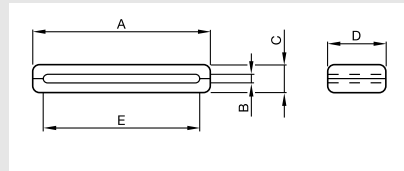
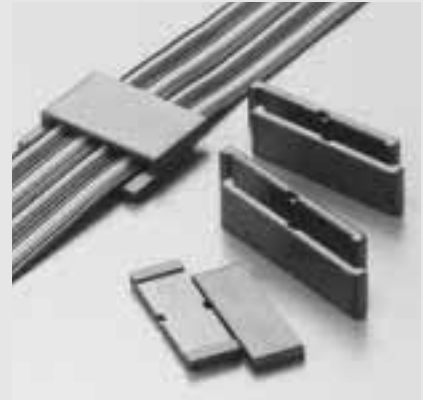

Part No.	Unit: mm					Impedance (Ω)		Max. Cable Width (mm)
	A	B	C	D	E	25MHz	100MHz	
FPH-6.8-5-3	10	1.8	5.0	6.0	6.8	16	29	6.5
FPH-10-6-5	6.8	0.9	3.0	5.0	4.6	-	15	4.3
FPH-31-12-3.5	31.0	0.4	3.5	12.0	27.0	17	46	26.5

No Mounting Parts available for all size

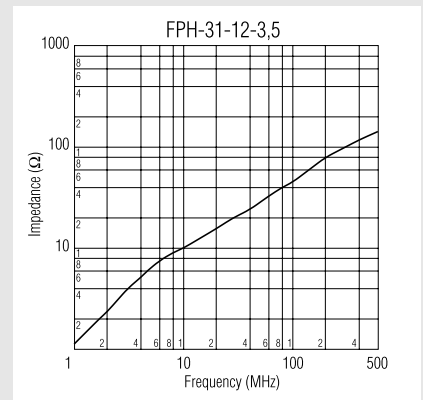
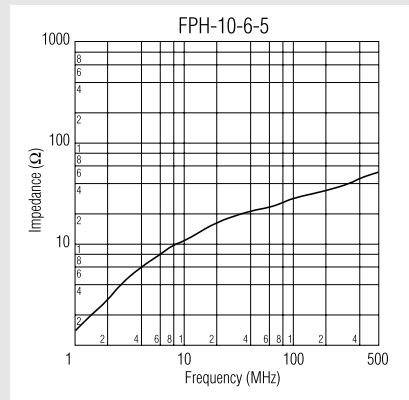
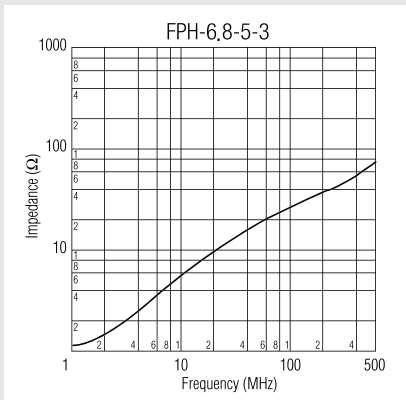

Features

- Employ high-performance ferrites (Nickel-Zinc) effective against high frequency noise.
- Designed to help reduce cost and time to market saving.
- Can be installed in its intended location before product assembly.

Applications

- Superior suppression of radiation emissions for full compliance with FCC, VDE and VCCI on Interface/ data line Ribbon/FPC cables of computers, peripheral/terminal equipment.

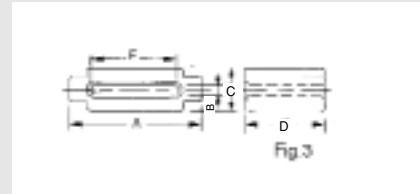
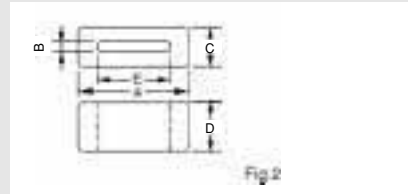
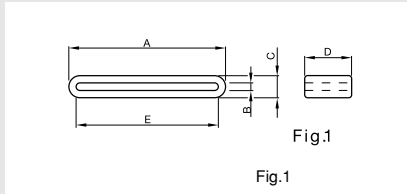
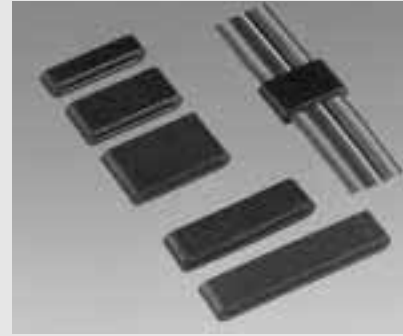

Part No.	Fig.	Unit: mm					Impedance (Ω)		Max. Cable Width (mm)
		A	B	C	D	E	25MHz	100MHz	
SSC-21-6.8-8B	2	21.0±0.5	1.3+0.4/-0.1	6.8±0.3	8.0±0.3	15.0±0.5	32	44	14
SSC-21-6.8-15B	2	21.0±0.5	1.3+0.4/-0.1	6.8±0.3	15.0±0.4	15.0±0.5	60	75	14
SSC-23.3-3-7	2	23.3±0.7	0.9±0.2	3.1±0.3	7.0±0.3	20.0±0.5	17	45	19
SSC-23.8-6.3-7	1	23.8±0.7	1.3±0.25	6.3±0.3	7.0±0.3	18.4±0.5	27	58	18
SSC-23.8-6.3-12.5	1	23.8±0.8	1.1±0.4	6.3±0.4	12.5±0.4	18.7±0.8	29	83	18
SSC-23.8-6.3-15	1	23.8±0.8	1.1±0.4	6.3±0.4	15.0±0.4	18.7±0.8	46	88	18
SSC-28.5-6.5-8	1	28.5±0.7	0.85±0.3	6.5±0.5	8.0±0.4	23.5±0.5	28	65	22
SSC-28-7.7-14.6	3	28.0±0.8	1.4±0.2	7.7±0.3	14.6±0.4	23.0±0.5	55	115	22
SSC-33.5-8	1	33.5±1.0	1.4±0.4	6.5±0.5	8.0±0.4	27.0±0.5	21	44	26
SSC-33.5-10	1	33.5±1.0	1.4±0.4	6.5±0.5	10.0±0.4	27.0±0.5	26	51	26
SSC-33.5-12	1	33.5±1.0	1.4±0.4	6.5±0.5	12.0±0.5	27.0±0.5	31	58	26
SSC-33.5-10-2	1	33.5±0.9	2.2±0.3	7.4±0.4	10.0±0.5	27.0±0.9/-0.6	27	50	26
SSC-33.5-20	1	33.5±0.9	1.4±0.4	6.5±0.5	20.0±0.6	27.15±0.75	58	149	26
SSC-38.5-4-12	2	38.5±1.0	0.8±0.3	4.0±0.2	12.0±0.5	35.0±0.7	25	68	34
SSC-38.5-12-25.4	2	38.53±0.58	1.9±0.38	12.06±0.38	25.4±0.76	26.77±0.76	86	166	26
SSC-40-10	1	40.0±1.0	1.4±0.4	6.5±0.5	10.0±0.45	35.0±0.7	23	54	34
SSC-40-12	1	40.0±1.0	1.4±0.4	6.5±0.5	12.0±0.5	35.0±0.7	27	60	34
SSC-45-8	1	45.2±1.0	1.4±0.4	6.5±0.5	8.0±0.3	40.0±0.8	19	46	39
SSC-45-12	1	45.2±1.0	1.4±0.4	6.5±0.5	12.0±0.5	40.0±0.8	26	61	39
SSC-50-12	1	49.6±1.0	1.4±0.4	6.5±0.5	12.0±0.5	44.0±0.8	25	64	43
SSC-58-12	1	57.6±1.20	1.4±0.4	6.5±0.5	12.0±0.5	52.0±0.8	25	63	51
SSC-60-12	1	60.6±1.1	1.4±0.4	6.5±0.5	12.0±0.5	55.2±1.0	35	92	54

Mounting Parts Page 10 + 16

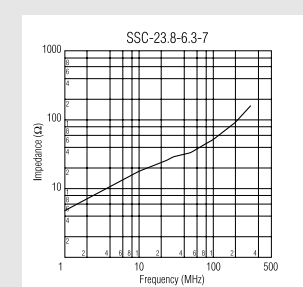
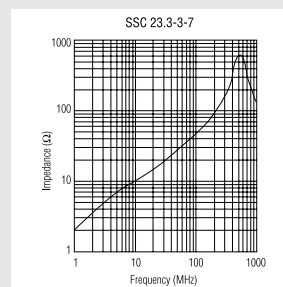
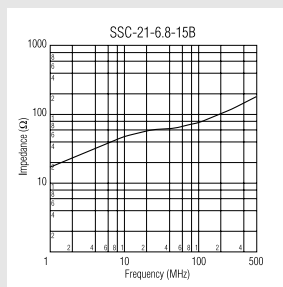
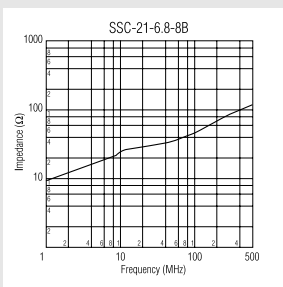

FILTERING

FLAT CABLE FERRITES

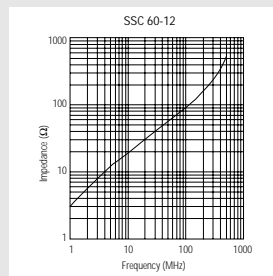
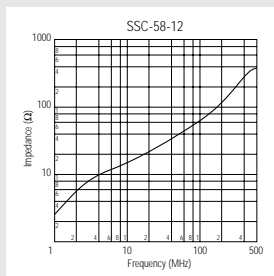
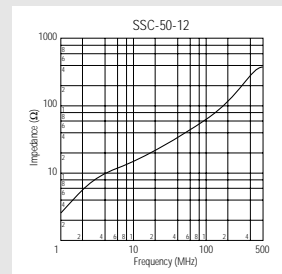
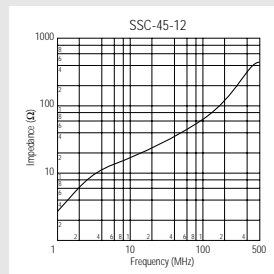
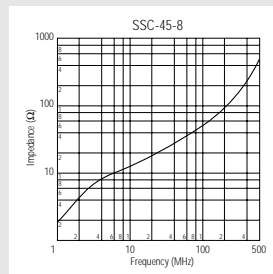
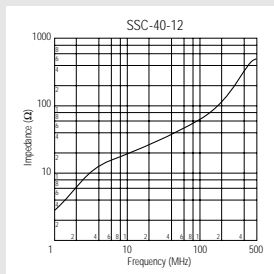
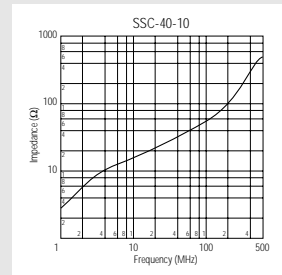
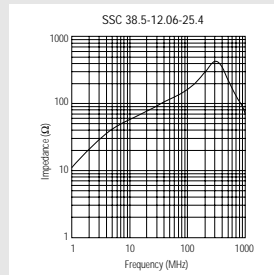
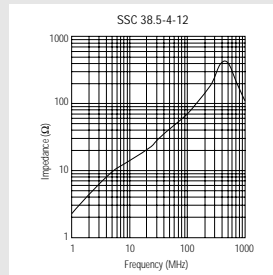
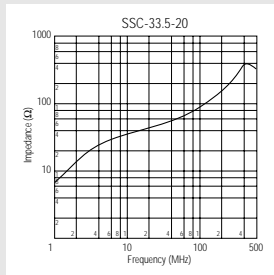
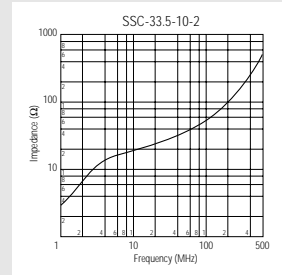
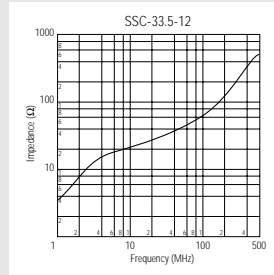
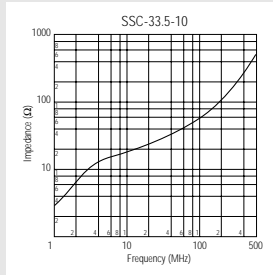
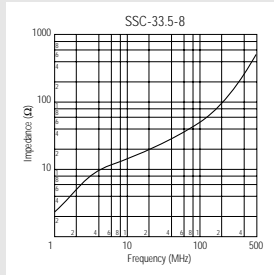
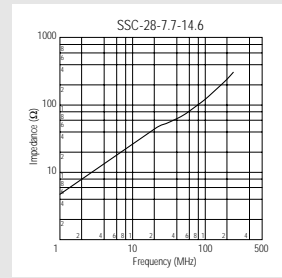
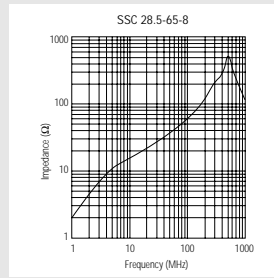
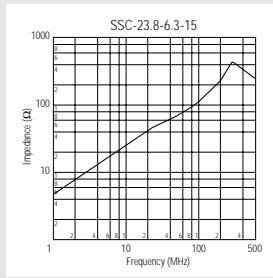
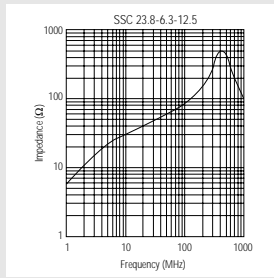

Features

- Employ high-performance ferrites (Nickel-Zinc) effective against high frequency noise.
- Designed to help reduce cost and time to market saving.
- Can be installed in its intended location before or after product assembly.

Application

- Superior suppression of radiation emissions for full compliance with FCC, VDE and VCCI on Interface data line ribbon cables of computers peripheral/terminal equipment.

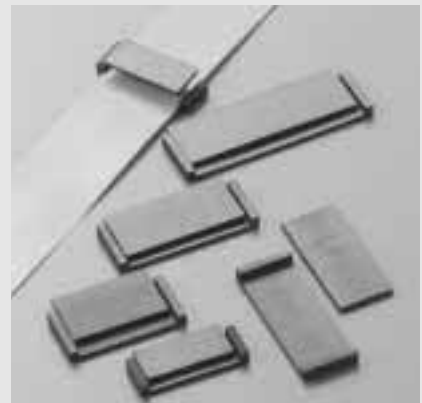
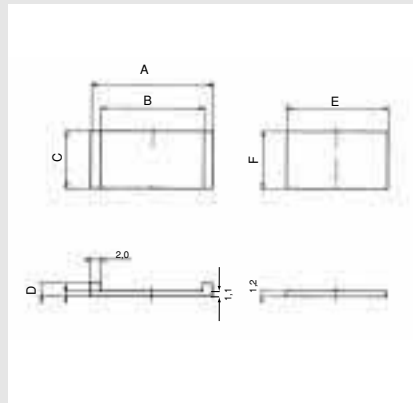

Part No.	Unit: mm						Impedance (Ω)		Max. Cable Width (mm)
	A	B	C	D	E	F	25MHz	100MHz	
FPO-23-8-3	23.0	19.0	8.0	2.8	18.5	8.0	18	42	18.5
FPO-25-12-3	25.0	21.0	12.0	2.8	20.5	12.0	25	56	20.5
FPO-31-12-3	31.0	27.0	12.0	2.8	26.5	12.0	24	55	26.6
FPI-20-12-1,2	-	-	-	-	20.5	12.0	-	-	-

No Mounting Parts available for all size

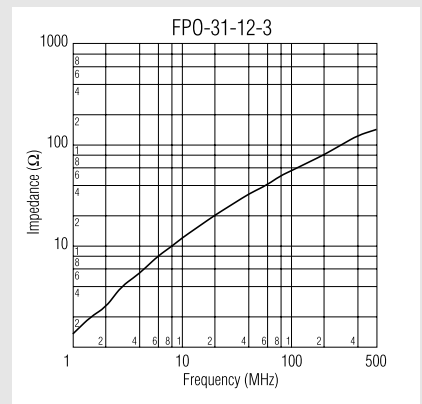
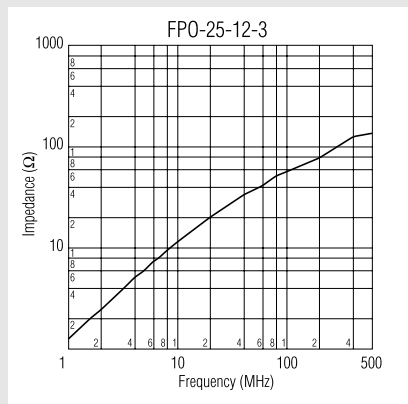
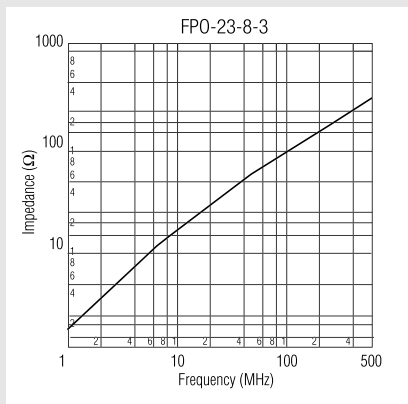

FILTERING

FLAT CABLE FERRITES

Features

- Employ high-performance ferrites (Nickel-Zinc) effective against high frequency noise.
- Designed to help reduce cost and time to market saving.
- Can be installed simply in its intended location before product assembly.
- Mounting part, FPCK12A, 12B is available

Applications

- Superior suppression of radiation emissions for full compliance with FCC, VDE and VCCI on Interface/data line FPC cables of computers, peripheral/terminal equipment.

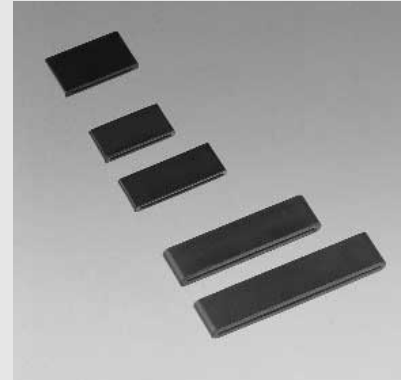
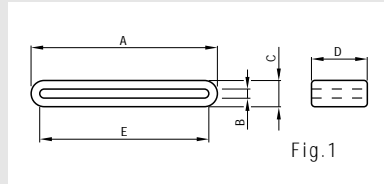

Part No.	Unit: mm					Impedance (Ω)		Max.Cable width (mm)
	A	B	C	D	E	25MHz	100MHz	
FPC 16-12	16.0±0.4	0.5+0.6/-0.0	5.0+0.0/-0.7	12.0±0.5	11.5±0.4	42	79	10.5
FPC-16-20	16.0±0.4	0.5+0.6/-0.0	5.0+0.0/-0.7	20.0±0.6	11.5±0.4	71	127	10.5
FPC-25-12	24.5±0.7	0.5+0.6/-0.0	5.0+0.0/-0.7	12.0±0.4	20.0±0.5	30	65	19.0
FPC-25-20	24.5±0.7	0.85±0.25	5.0+0.0/-0.7	20.0±0.6	20.0±0.5	50	103	19.0
FPC-31-12	31.0±1.0	1.0±0.2	5.0±0.3	12.0±0.5	27.0±0.7	26	66	26.0
FPC-46-12	46.0+1.1/-0.8	0.5+1.0/-0.0	5+0.0/-0.8	12.0±0.8	41.5±0.9	23	65	40.5
FPC-56-12	56.2±1.1	0.5+1.1/-0.0	5+0.3/-1.1	12.0±0.5	52.4±0.9	23	66	51.0
FPC-24-12-3	23.3±0.7	0.9±0.2	3.1±0.3	12.0±0.5	20.0±0.5	20	41	19.0
FPC-31-12-3	31.0±0.8	0.9±0.2	3.0±0.2	12.0±0.5	27.0±0.6	17	42	26.0

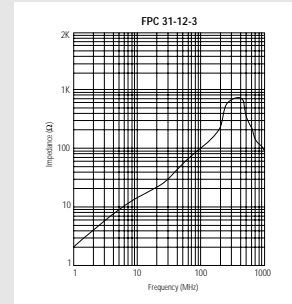
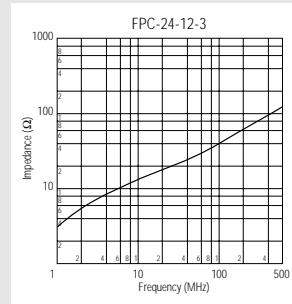
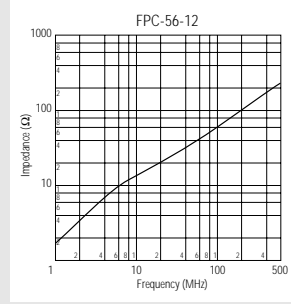
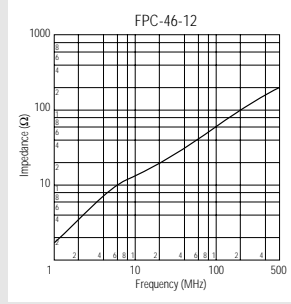
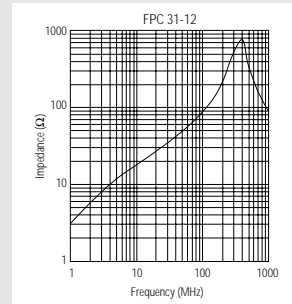
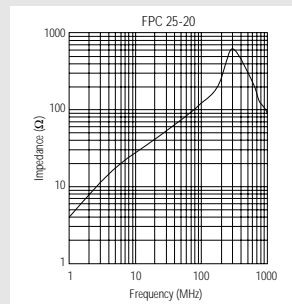
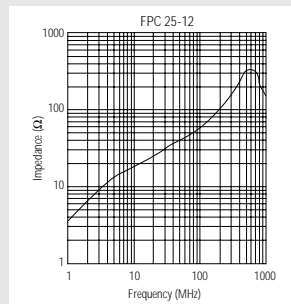
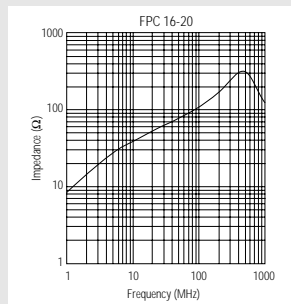
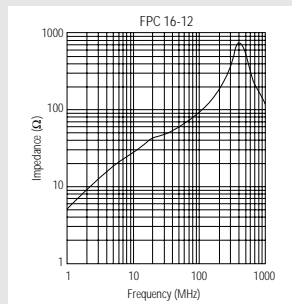

KE KITAGAWA

Elbinger Straße 3-5 · D-63110 Rodgau-Jügesheim · Germany · Telefon 0 61 06/85 24 - 0 · Telefax 0 61 06/85 24-30 (31)

FILTERING

FLAT CABLE FERRITES

Mounting Parts for FPC type cores

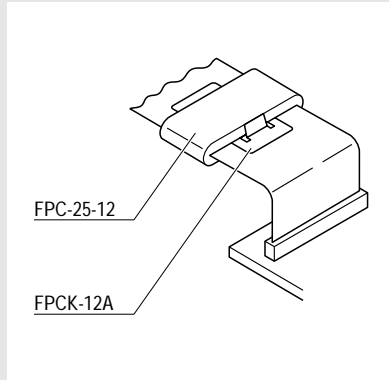

Part No.: FPCK-12B
 Material: PVC
 Applicable: FPC-31-12
 FPC-46-12
 FPC-56-12
 FPC-31-12-3

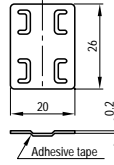

Part No.: FPCK-12A
 Material: PVC
 Applicable: FPC-16-12
 FPC-25-12
 FPC-24-12-3

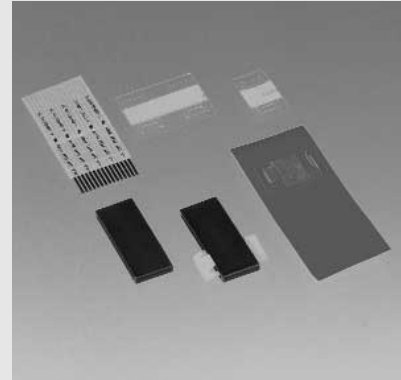
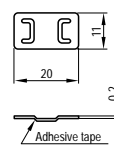

Part No.	Applicable
FPCK-12B	FPC-31-12; FPC-46-12; FPC-56-12; FPC-31-12-3
FPCK-12A	FPC-16-12; FPC-25-12; FPC-24-12-3

Mounting Parts for SSC type cores

Features

- Plastic clip for SSC-cores
- Material: ABS
- Colour: black

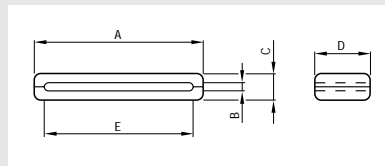

Part No.	Unit: mm					Applicable
	A	B	C	D	E	
FCP-15P	34,5	0,8	12,0	19,0	21,6	SSC-21-6,8-8 / 21-6,8-15 / 23,8-6,3-7 / 23,8-6,3-15 / 28-7-14,6
FCP-25P	46,5	0,8	10,6	16,0	34,3	SSC-33,5-8 / 33,5-10 / 33,5-12 / 33,5-10-2 / 40-10 / 40-12
FCP-34P	56,6	0,8	10,4	16,0	43,2	SSC-45-8 / 45-12 / 50-12
FCP-40P	64,1	0,8	10,4	16,0	53,3	SSC-58-12

FILTERING

FLAT CABLE FERRITES

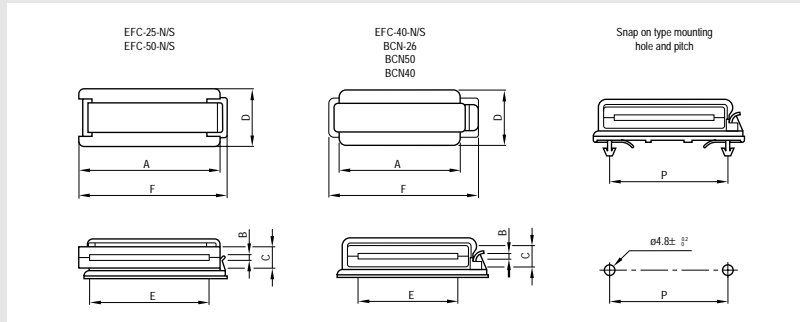

Features

- Split construction permits easy insertion of cables already wired and installed, or cables with connectors.
- Nylon mounting clamp comes with.
- Split block cores supported with plastic mounting clamp for flat cables

Applications

- For noise problems arising in office automation equipment or other digital equipment.

Part No.	Unit: mm							Impedance (Ω)		Applicable cable
	A	B	C	D	E	F	P	25MHz	100MHz	
EFC-25S	44.0	2.0	13.0	28.5	33.0	47.0	33.0	65	150	flat cable Less than the dimension E
EFC-40S	63.0	2.0	13.0	28.5	52.0	77.0	64.5	72	175	
EFC-50S	76.5	2.0	13.0	28.5	64.5	79.5	64.5	62	185	
EFC-25N	44.0	2.0	13.0	28.5	33.0	47.0	—	65	150	
EFC-40N	63.0	2.0	13.0	28.5	52.4	77.0	—	72	175	
EFC-50N	76.5	2.0	13.0	28.5	64.5	79.5	—	62	185	
BCN-26	45.0	2.0	13.0	28.5	34.0	59.0	—	92	180	
BCN-40	63.0	2.0	13.0	28.5	52.0	76.5	—	72	180	
BCN-50	76.5	2.0	13.0	28.5	64.5	90.7	—	63	185	

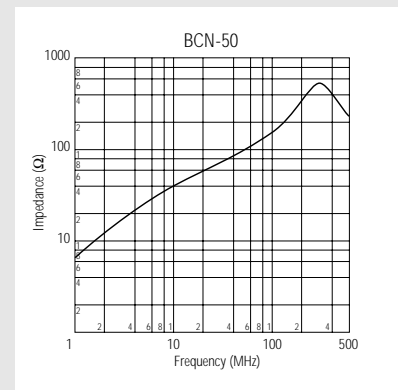
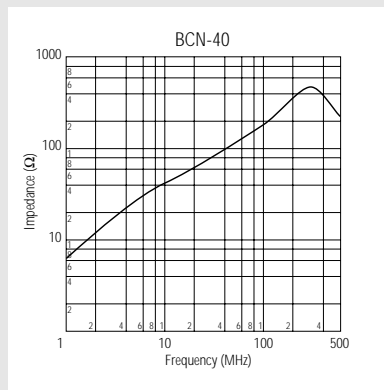
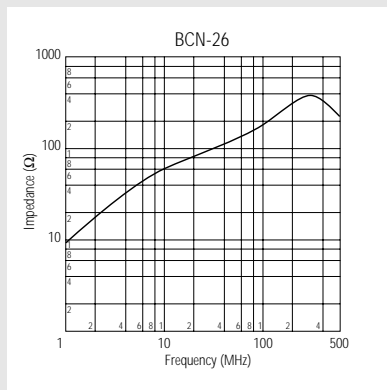
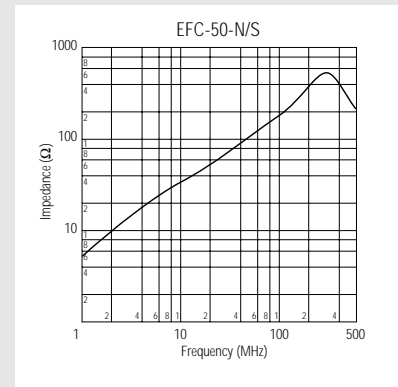
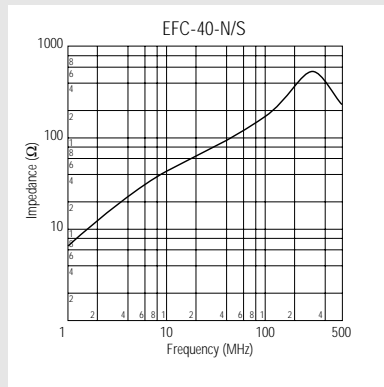
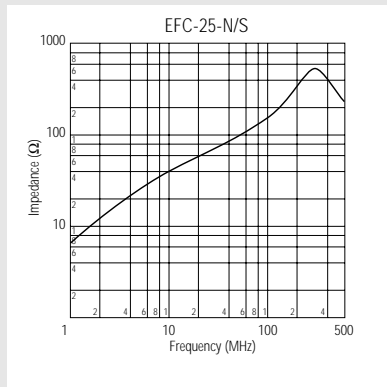

FILTERING

FLAT CABLE FERRITES

Features

- Kitagawa offers a line of bisected flat cable suppression cores to attenuate radiated EMI emissions from ribbon cables.
- Ferrite assembly press-fitted into a pair of metal clips.
- Metal clips included, except FP 16,5-2-10.25

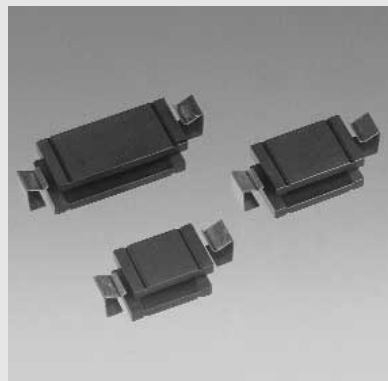
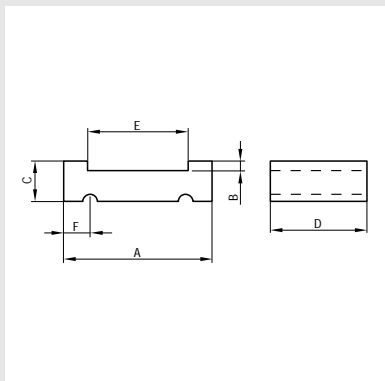

Applications

- Internal ribbon cables between PCB and Data line.
- To suppress radiated EMI emission from flat cable and ribbon cable.

Part No.		Unit: mm					Impedance (Ω)	
		A	B	C	D	E	25MHz	100MHz
FP 16.5-2-10.25		16.5±0.25	0.6±0.2	2.0±0.2	10.25±0.2	12.5±0.3	29	72
FP 38-6.35-10	*	38.0±1.0	0.8±0.2	6.35±0.25	10.0±0.4	26.6±0.7	45	107
FP 38-6.35-25.4	*	38.0±1.0	0.8±0.2	6.35±0.25	25.4±0.75	26.6±0.7	103	173
FP 45-6.35-10	*	45.0±0.75	0.8±0.2	6.35±0.25	10.0±0.4	34.4±0.7	41	98
FP 45-6.35-28.5	**	45.0±0.75	0.8±0.2	6.35±0.25	28.5±0.7	34.4±0.7	84	166
FP 55.1-6.35-28.5	**	55.1±1.2	0.8±0.2	6.35±0.25	28.5±0.7	43.7±1.0	78	179
FP 63.5-6.35-13	*	63.5±1.3	0.8±0.2	6.35±0.25	13.0±0.4	52.0±1.1	45	114
FP 63.5-6.35-15	*	63.5±1.3	0.8±0.2	6.35±0.25	15.0±0.4	52.0±1.1	50	124
FP 63.5-6.35-28.5	**	63.5±1.3	0.8±0.2	6.35±0.25	28.5±0.7	52.0±1.1	74	155
FP 76.2-6.35-28.5	**	76.2±1.5	0.8±0.2	6.35±0.25	28.5±0.7	65.3±1.3	72	200

* Metal clips (KE-MC-10 or KE MC-13) are included

** Metal clips (KE-MC-13) are included, however Plastic clip KE-PC-28.5 is also available as option

Metal Clip for FP-core

Features

- Metal clip for FP-core
- Part No. KE-MC-10
- Part No. KE-MC-13

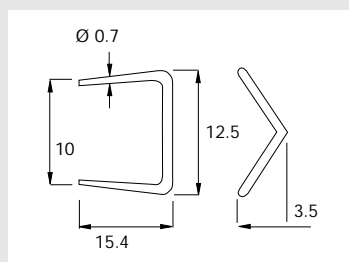

KE-MC-10

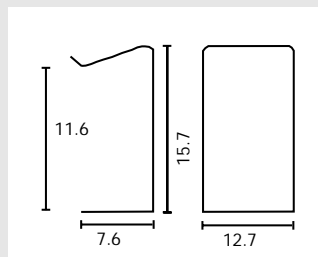

KE-MC-13

KE KITAGAWA

Elbinger Straße 3-5 · D-63110 Rodgau-Jügesheim · FR-Germany · Telefon 0 61 06/85 24 - 0 · Telefax 0 61 06/85 24-30 (31)

FILTERING

FLAT CABLE FERRITES

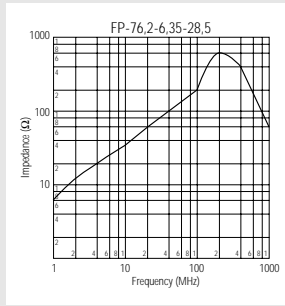
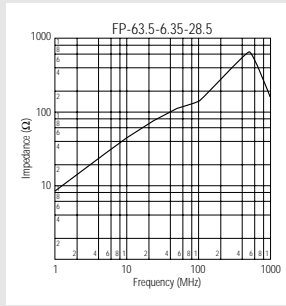
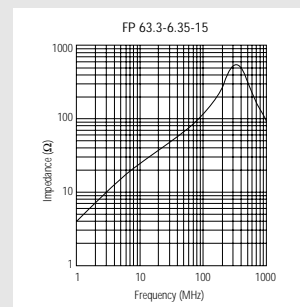
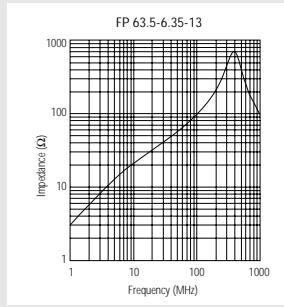
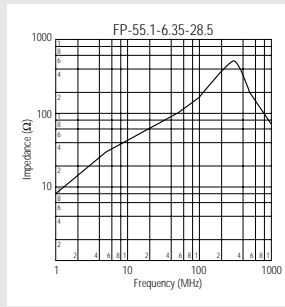
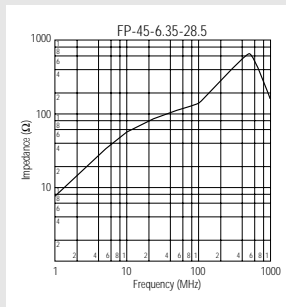
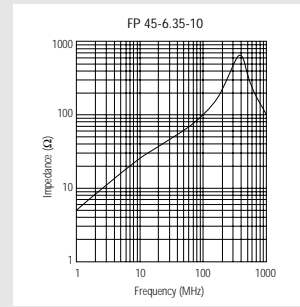
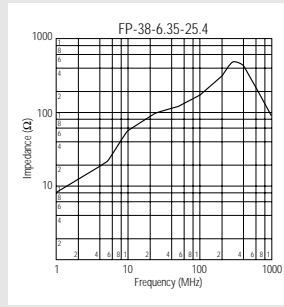
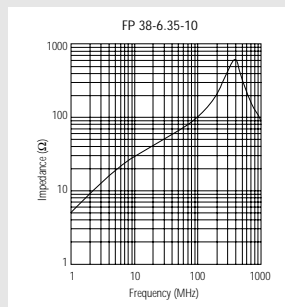
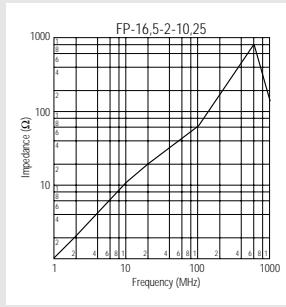

Mounting parts for FP-cores

Features

- Plastic clip for FP-cores
- Nylon 6.6 (UL 94 V-2)
- Colour grey
- Screw mounting
- Part No. KE-PC-28.5

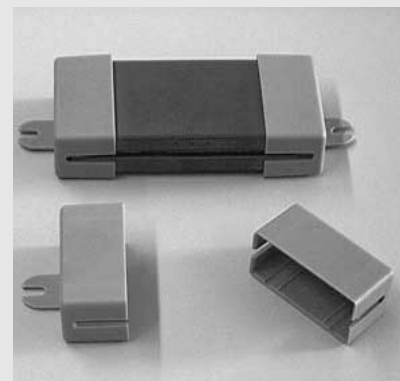
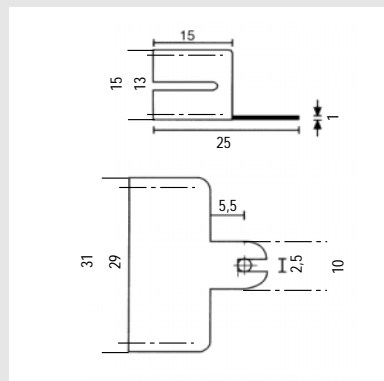

KE-PC-28.5