

# NAIS

## SMALL POLARIZED RELAY WITH HIGH SENSITIVITY

# TF-RELAYS

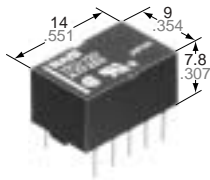

mm inch

### FEATURES

- **High sensitivity:**  
80 mW Nominal operating power (Single side stable 3-12 V type)
- **Surge voltage withstand: 1500 V FCC Part 68**
- **Minimal magnetic interference allows high density mounting**
- **Sealed construction allows automatic cleaning**
- **Self-clinching terminal also available**

### SPECIFICATIONS

#### Contact

Arrangement	2 Form C	
Initial contact resistance, max. (By voltage drop 6 V DC 1 A)	50 mΩ	
Contact material	Gold-clad silver	
Rating	Nominal switching capacity (resistive load)	1 A 30 V DC, 0.5 A 125 V AC
	Max. switching power (resistive load)	30 W, 62.5 VA
	Max. switching voltage	110 V DC, 125 V AC
	Max. switching current	1 A
	Min. switching capacity *1	10 μA 10 mV DC
Nominal operating power	Single side stable	80 mW (3 to 12 V DC) 140 mW (24 V DC) 260 mW (48 V DC)
	1 coil latching	55 mW (3 to 12 V DC) 100 mW (24 V DC)
	2 coil latching	110 mW (3 to 12 V DC) 200 mW (24 V DC)
Expected life (min. operations)	Mechanical (at 180 cpm)	10 <sup>8</sup>
	Electrical (at 20 cpm)	1 A 30 V DC resistive load 2×10 <sup>5</sup>
		0.5 A 125 V AC resistive load 10 <sup>5</sup>

#### Note:

\*1 This value can change due to the switching frequency, environmental conditions, and desired reliability level, therefore it is recommended to check this with the actual load.

#### Characteristics

Initial insulation resistance*1		Min. 1,000 MΩ (at 500 V DC)
Initial breakdown voltage	Between open contacts	750 Vrms for 1 min. (Detection current: 10 mA)
	Between contact and coil	1,000 Vrms for 1 min. (Detection current: 10 mA)
	Between contact sets	1,000 Vrms for 1 min. (Detection current: 10 mA)
FCC surge voltage between open contacts		1,500 V
Temperature rise*2 (at 20°C)		Max. 50°C
Operate time [Set time]*3 (at 20°C)		Max. 4 ms (Approx. 2 ms) [Max. 4 ms (Approx. 2 ms)]
Release time [Reset time]*4 (at 20°C)		Max. 4 ms (Approx. 1 ms) [Max. 4 ms (Approx. 2 ms)]
Shock resistance	Functional*5	Min. 490 m/s <sup>2</sup> {50 G}
	Destructive*6	Min. 980 m/s <sup>2</sup> {100 G}
Vibration resistance	Functional*7	176.4 m/s <sup>2</sup> {18G}, 10 to 55 Hz at double amplitude of 3 mm
	Destructive	294 m/s <sup>2</sup> {30G}, 10 to 55 Hz at double amplitude of 5 mm
Conditions for operation, transport and storage*8 (Not freezing and condensing at low temperature)	Ambient temperature	-40°C to +70°C -40°F to +158°F
	Humidity	5 to 85% R.H.
Unit weight		Approx. 2 g .071 oz

#### Remarks

- \* Specifications will vary with foreign standards certification ratings.
- \*1 Measurement at same location as "Initial breakdown voltage" section.
- \*2 By resistive method, nominal voltage applied to the coil; contact carrying current: 1 A.
- \*3 Nominal voltage applied to the coil, excluding contact bounce time.
- \*4 Nominal voltage applied to the coil, excluding contact bounce time without diode.
- \*5 Half-wave pulse of sine wave: 11 ms; detection time: 10 μs.
- \*6 Half-wave pulse of sine wave: 6 ms.
- \*7 Detection time: 10 μs.
- \*8 Refer to 4. Conditions for operation, transport and storage mentioned in Cautions for use in catalog.

### ORDERING INFORMATION

Ex. TF 2 — L — H — 3V

Contact arrangement	Operating function	Terminal shape	Coil voltage(DC)
2:2 Form C	Nil: Single side stable L: 1 coil latching L2: 2 coil latching	Nil: Standard PC board terminal H: Self-clinching terminal	3,4,5,5,6,9,12, 24,48 V

\*48 V coil type: Single side stable only

Note: AgPd stationary contact types available for high resistance against contact sticking. When ordering, please add suffix "-3" like TF2-12V-3.

# TYPES AND COIL DATA (at 20°C 68°F)

## 1. Single side stable

Part No.		Nominal voltage, V DC	Pick-up voltage, V DC (max.)	Drop-out voltage, V DC (min.)	Nominal operating current, mA (±10%)	Coil resistance, Ω (±10%)	Nominal operating power, mW	Max. allowable voltage, V DC
Standard PC board terminal	Self-clinching terminal							
TF2-3 V	TF2-H-3 V	3	2.25	0.3	26.7	112.5	80	4.5
TF2-4.5 V	TF2-H-4.5 V	4.5	3.38	0.45	17.8	253	80	6.7
TF2-5 V	TF2-H-5 V	5	3.75	0.5	16	312.5	80	7.5
TF2-6 V	TF2-H-6 V	6	4.5	0.6	13.3	450	80	9
TF2-9 V	TF2-H-9 V	9	6.75	0.9	8.9	1,012.5	80	13.5
TF2-12 V	TF2-H-12 V	12	9	1.2	6.7	1,800	80	18
TF2-24 V	TF2-H-24 V	24	18	2.4	5.8	4,100	140	36
TF2-48 V	TF2-H-48 V	48	36	4.8	5.4	8,860	260	57.6

## 2. 1 Coil latching

Part No.		Nominal voltage, V DC	Set voltage, V DC (max.)	Reset voltage, V DC (max.)	Nominal operating current, mA (±10%)	Coil resistance, Ω (±10%)	Nominal operating power, mW	Max. allowable voltage, V DC
Standard PC board terminal	Self-clinching terminal							
TF2-L-3 V	TF2-L-H-3 V	3	2.25	2.25	18.3	163.6	55	4.5
TF2-L-4.5 V	TF2-L-H-4.5 V	4.5	3.38	3.38	12.2	368.2	55	6.7
TF2-L-5 V	TF2-L-H-5 V	5	3.75	3.75	11	454.5	55	7.5
TF2-L-6 V	TF2-L-H-6 V	6	4.5	4.5	9.2	654.5	55	9
TF2-L-9 V	TF2-L-H-9 V	9	6.75	6.75	6.1	1,472	55	13.5
TF2-L-12 V	TF2-L-H-12 V	12	9	9	4.6	2,618	55	18
TF2-L-24 V	TF2-L-H-24 V	24	18	18	4.2	5,760	100	36

## 3. 2 Coil latching

Part No.		Nominal voltage, V DC	Set voltage, V DC (max.)	Reset voltage, V DC (max.)	Nominal operating current, mA (±10%)	Coil resistance, Ω (±10%)	Nominal operating power, mW	Max. allowable voltage, V DC
Standard PC board terminal	Self-clinching terminal							
TF2-L2-3 V	TF2-L2-H-3 V	3	2.25	2.25	36.7	81.8	110	4.5
TF2-L2-4.5 V	TF2-L2-H-4.5 V	4.5	3.38	3.38	24.4	184.1	110	6.7
TF2-L2-5 V	TF2-L2-H-5 V	5	3.75	3.75	22	227.3	110	7.5
TF2-L2-6 V	TF2-L2-H-6 V	6	4.5	4.5	18.3	327.3	110	9
TF2-L2-9 V	TF2-L2-H-9 V	9	6.75	6.75	12.2	736.4	110	13.5
TF2-L2-12 V	TF2-L2-H-12 V	12	9	9	9.2	1,309	110	18
TF2-L2-24 V	TF2-L2-H-24 V	24	18	18	8.3	2,880	200	36

**Notes:**

1. Specified value of the pick-up, drop-out, set and reset voltage is with the condition of square wave coil pulse.
2. Standard packing: Tube: 50 pcs.; Case: 1,000 pcs.
3. In case of 5 V drive circuit, it is recommended to use 4.5 V type relay.
4. AgPd stationary contact types available for high resistance against contact sticking. When ordering, please add suffix "-3" like TF2-12V-3.

## DIMENSIONS

mm inch



Standard PC board terminal

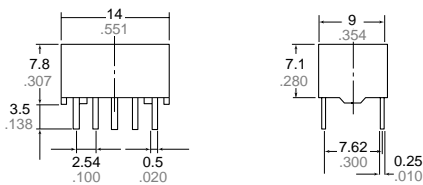

PC board pattern (Copper-side view)

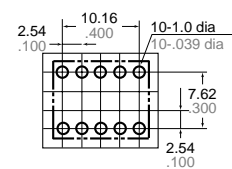

Tolerance: ±0.1 ±.004

Self-clinching terminal

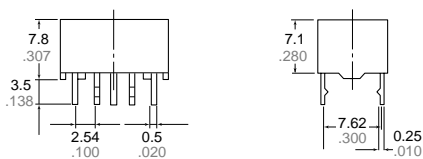

Schematic (Bottom view)

Single side stable (Deenergized condition)

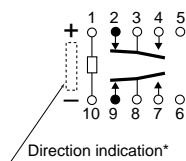

1-coil latching (Reset condition)

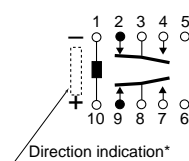

2-coil latching (Reset condition)

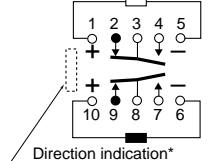

General tolerance: ±0.3 ±.012

\*Orientation stripe typical-located on top of relay.

REFERENCE DATA

1. Maximum switching capacity

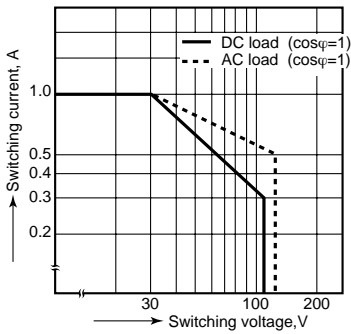

2. Life curve

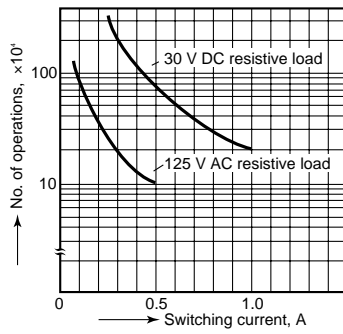

3. Mechanical life

Tested sample: TF2-12V, 10 pcs.

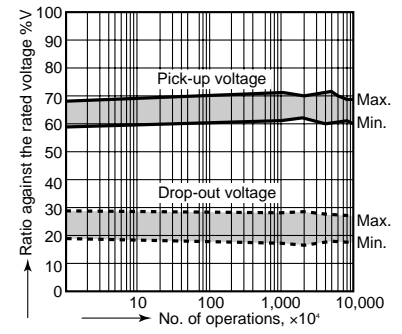

4.-(1) Electrical life (DC load)

Tested sample: TF2-12V, 6 pcs.  
Condition: 1 A 30 V DC resistive load, 20 cpm  
Change of pick-up and drop-out voltage

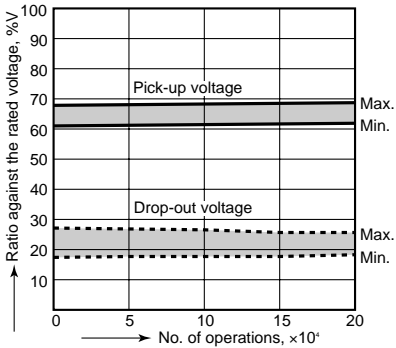

Change of contact resistance

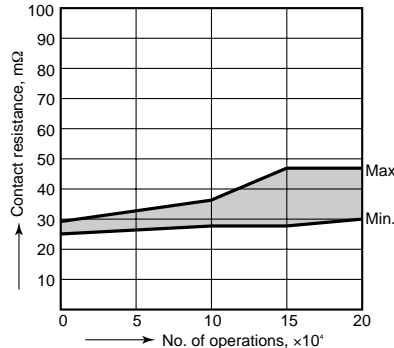

4.-(2) Electrical life (AC load)

Tested sample: TF2-12V, 6 pcs  
Condition: 0.5 A 125 V AC resistive load, 20 cpm  
Change of pick-up and drop-out voltage

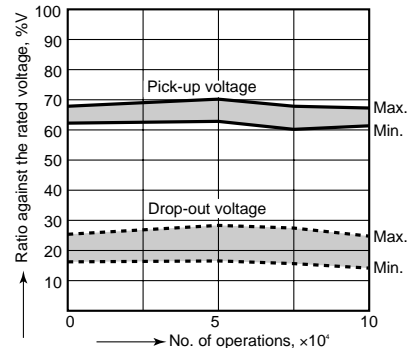

5. Coil temperature rise

Tested sample: TF2-xxV  
Measured portion: Inside the coil  
Ambient temperature: 30°C 86°F

Change of contact resistance

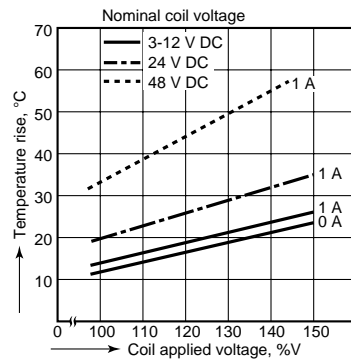
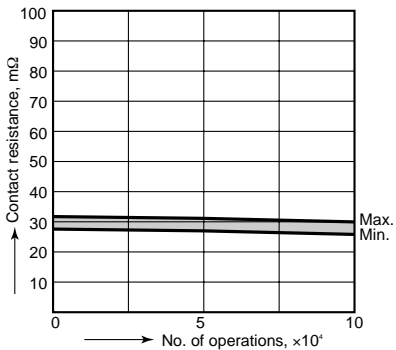

6. Operate/release time characteristics

Tested sample: TF2-12V, 5 pcs.

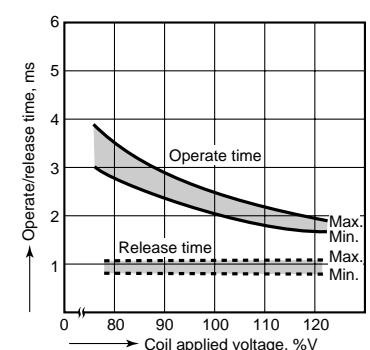

7. Set/reset time characteristics

Tested sample: TF2-L2-12V, 5 pcs.

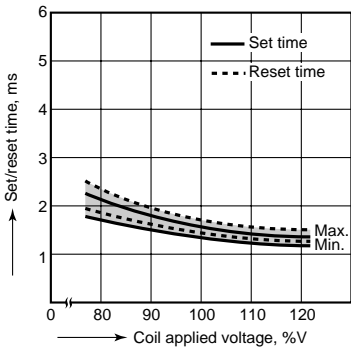

8. Distribution of pick-up and drop-out voltage

Tested sample: TF2-12V, 50 pcs.

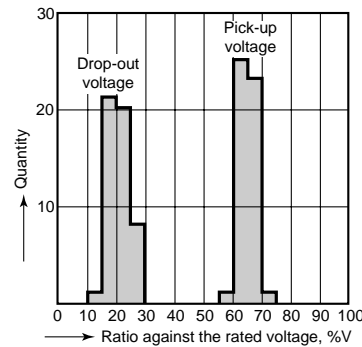

9. Distribution of set and reset voltage

Tested sample: TF2-L2-12V, 20 pcs.

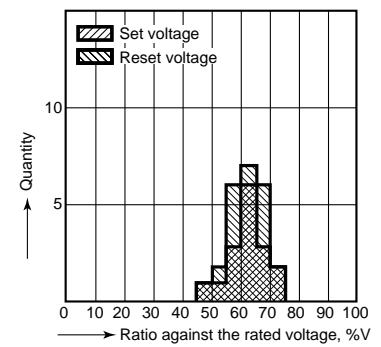

10. Ambient temperature characteristics  
Tested sample: TF2-12V, 5 pcs.

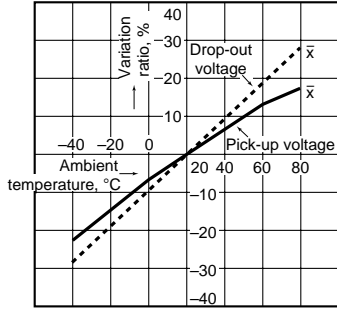

11. Distribution of contact resistance  
Tested sample: TF2-12V, 30 pcs. (30, × 4 contacts)

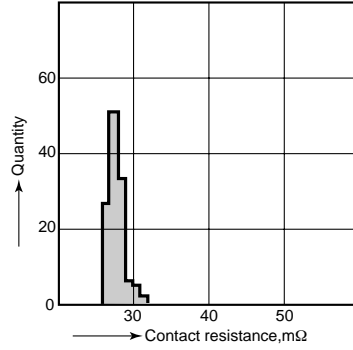

12.-(1) High-frequency characteristics  
Tested sample: TF2-xxV  
Isolation characteristics

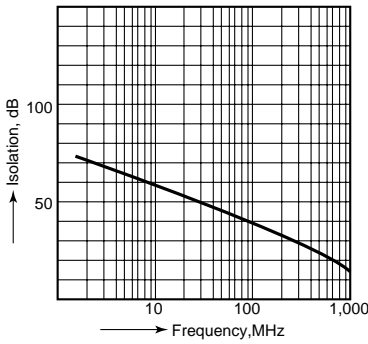

12.-(2) High-frequency characteristics  
Tested sample: TF2-xxV  
Insertion loss characteristics

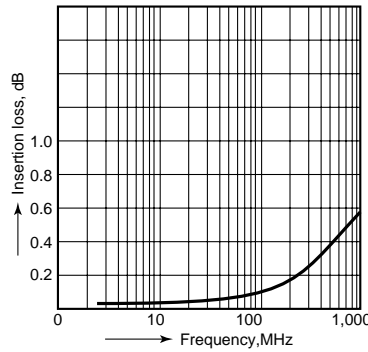

12.-(3) High-frequency characteristics  
Tested sample: TF2-xxV  
V.S.W.R.

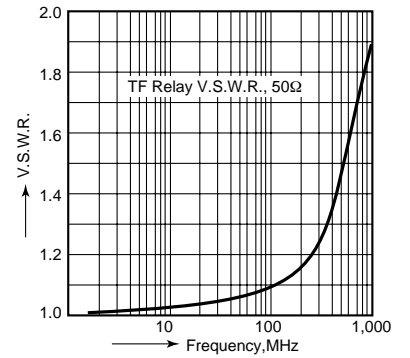

13.-(1) Malfunctional shock (single side stable)  
Tested sample: TF2-12V, 6 pcs

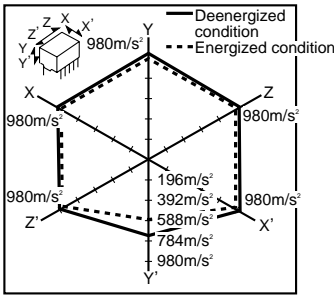

13.-(2) Malfunctional shock (latching)  
Tested sample: TF2-L-12V, 6 pcs.

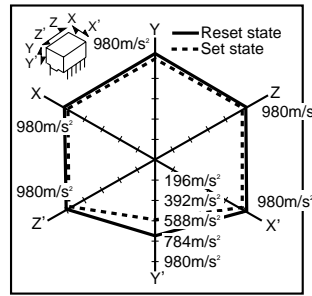

14.-(1) Influence of adjacent mounting

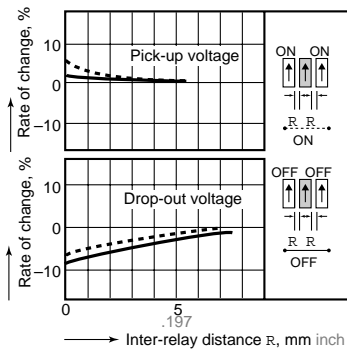

14.-(2) Influence of adjacent mounting

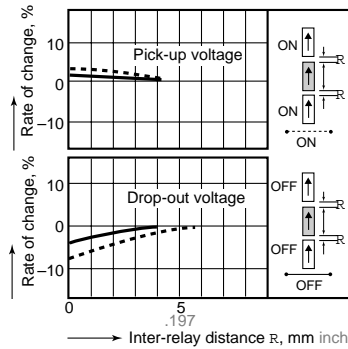

14.-(3) Influence of adjacent mounting

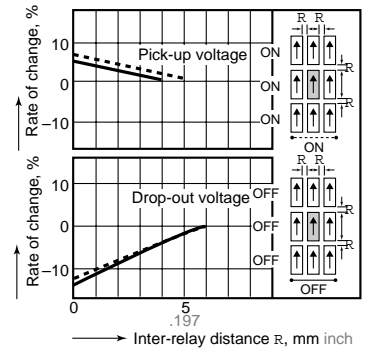

15. Actual load test  
 Tested sample: TF2-12V  
 (35 mA 48 V DC wire spring relay load)

Change of pick-up and drop-out voltage

Change of contact resistance

Circuit

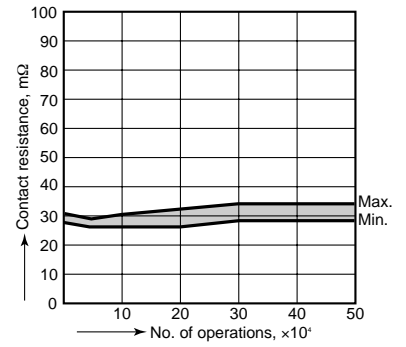
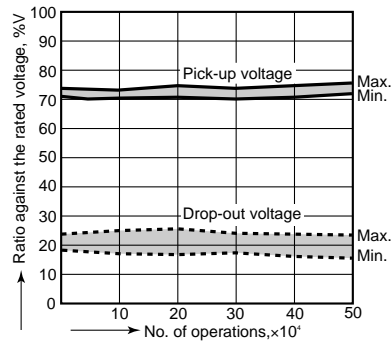
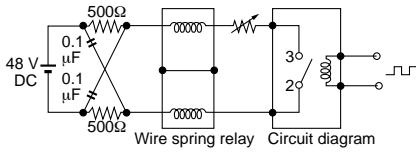

**For Cautions for Use, see Pages in catalog.**