

Ultra Subminiature Detection Switch with Slide Mechanism and Lever Actuator

- Compact (8×6×4.2 mm (W×H×D)) and light (approximately 0.3 g) with long, 3-mm stroke.
- Built-in slide mechanism allows selection of shorting or non-shorting timing to match the application.
- Ideal for a wide variety of applications, including compact household appliances, audio equipment, office machines, and telecommunications equipment.

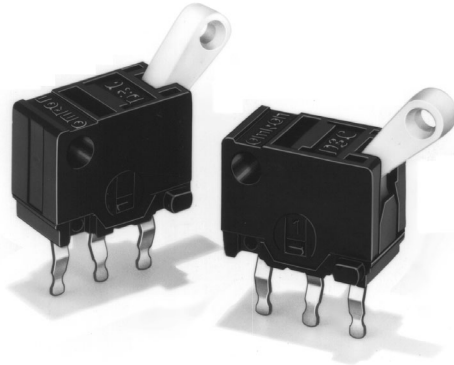

Ordering Information

■ Model Number Legend

D3C-□₁2□₂0

1. Switching Timing

- 1: Non-shorting
- 2: Shorting

2. Maximum Operating Force

- 1: 1.28 N {130 gf}
- 2: 0.39 N {40 gf}

■ List of Models

Actuator	OF 1.28 N {130 gf}		OF 0.39 N {40 gf}	
	Non-shorting Model	Shorting Model	Non-shorting Model	Shorting Model
Rotary lever 	D3C-1210	D3C-2210	D3C-1220	D3C-2220

Specifications

■ Ratings

Electrical ratings	0.1 A at 30 VDC (resistive load)
---------------------------	----------------------------------

Note: The ratings values apply under the following test conditions:

- Ambient temperature: 20±2°C
- Ambient humidity: 65±5%
- Operating frequency: 30 operations/min

■ Characteristics

Operating speed	1 to 500 mm/s
Operating frequency	Mechanical: 200 operations/min max. Electrical: 30 operations/min max.
Insulation resistance	100 MΩ min. (at 250 VDC)
Contact resistance (initial value)	50 mΩ max.
Dielectric strength	250 VAC, 50/60 Hz for 1 min between terminals of same polarity 250 VAC, 50/60 Hz for 1 min between current-carrying metal parts and ground
Vibration resistance	Malfunction: 10 to 55 Hz, 1.5-mm double amplitude
Shock resistance	Destruction: 1,000 m/s ² {approx. 100G} max. Malfunction: 300 m/s ² {approx. 30G} max.
Durability (see note 2)	50,000 operations min. (30 operations/min)
Degree of protection	IEC IP00
Degree of protection against electric shock	Class III
Proof tracking index (PTI)	175
Ambient operating temperature	-20°C to 80°C (at ambient humidity of 60% max.) (with no icing)
Ambient operating humidity	85% max. (for 5°C to 35°C)
Weight	Approx. 0.3 g

- Note:** 1. The data given above are initial values.
2. For testing conditions, consult your OMRON sales representative.

■ Contact Specifications

Contact	Specification	Slide
	Material	Silver plated
Minimum applicable load (see note)		1 mA at 5 VDC

- Note:** For more information on the minimum applicable load, refer to *Using Micro Loads* on page 257.

■ Contact Form

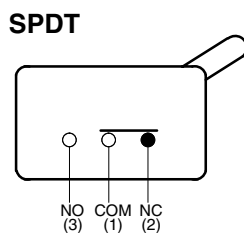

Dimensions

■ Mounting Holes

Note: All units are in millimeters unless otherwise indicated.

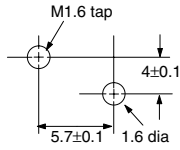

■ Dimensions and Operating Characteristics

- Note:**
1. All units are in millimeters unless otherwise indicated.
 2. Unless otherwise specified, a tolerance of ±0.4 mm applies to all dimensions.

D3C-1210/-2210
D3C-1220/-2220

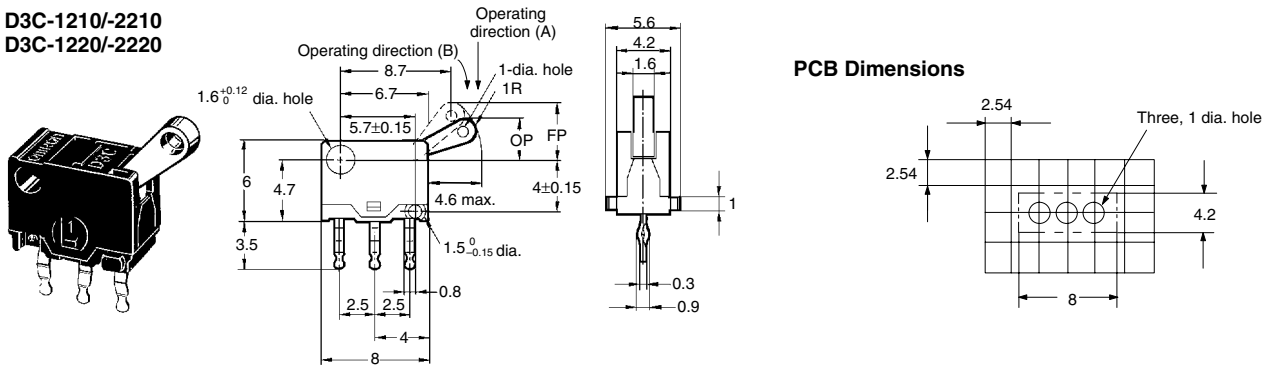

Model	Non-shorting Models		Shorting Models	
	D3C-1210	D3C-1220	D3C-2210	D3C-2220
OF max.	1.28 N {130 gf} (0.98 N)	0.39 N {40 gf} (0.29 N)	1.28 N {130 gf} (0.98 N)	0.39 N {40 gf} (0.29 N)
RF min.	0.10 N {10 gf} (0.15 N)	0.03 N {3 gf} (0.05 N)	0.10 N {10 gf} (0.15 N)	0.03 N {3 gf} (0.05 N)
FP max.	4.8 mm		4.8 mm	
OP1	3.5±0.3 mm		3.4±0.3 mm	
OP2	2.5±0.3 mm		2.6±0.3 mm	
TTP	1.3±0.4 mm		1.3±0.4 mm	

Note: The values for operating characteristics apply for operation in the A direction (▼) shown above. The values in parentheses indicate those for operation in the B direction (▼).

Switching Timing

Non-shorting Model

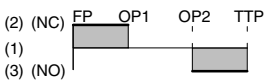

Shorting Model

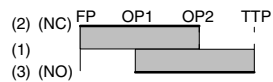

Precautions

Refer to pages 26 to 31 for common precautions.

■ Cautions

Terminal Connection

When soldering the lead wire to the terminal, first bind the lead wire to the terminal and then apply the 6 (Sn) : 4 (Pb) solder to the terminal. Complete soldering within 5 s at a soldering iron temperature of 260°C. Soldering at a temperature exceeding 260°C, soldering for more than 5 s, or repeated soldering will degrade the Switch characteristics.

When soldering the lead wire to the PCB terminal, pay careful attention so that the flux and solder liquid level does not exceed the PCB level.

It is also recommended that you apply flux guard to the mounting surface of the Switch.

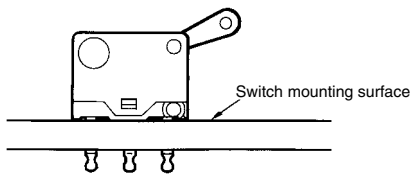

■ Correct Use

Mounting

Turn OFF the power supply before mounting or removing the Switch, wiring, or performing maintenance or inspection. Failure to do so may result in electric shock or burning.

Use M1.6 mounting screws with plane washers or spring washers to securely mount the Switch. Tighten the screws to a torque of 4.9 to $9.8 \times 10^{-2} \text{ N} \cdot \text{m}$ (0.5 to 1 kgf · cm).

Mount the Switch onto a flat surface. Mounting on an uneven surface may cause deformation of the Switch, resulting in faulty operation or breakage in the housing.

Application of Operation Force to the Lever

Apply operation forces to the lever in its operating direction. Applying operating force to the lever in any other directions will damage the Switch or cause malfunction.

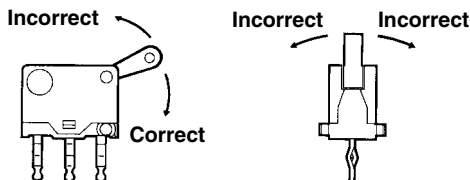

Mounting Plate

Use materials other than ABS or polycarbonate for the mounting plate. Since grease is used for the Switch, cracks may be caused if grease from the Switch comes in contact with such materials.

Using Micro Loads

Using a model for ordinary loads to open or close the contact of a micro load circuit may result in faulty contact. Use models that operate in the following range. However, even when using micro load models within the operating range shown below, if inrush current occurs when the contact is opened or closed, it may increase contact wear and so decrease durability. Therefore, insert a contact protection circuit where necessary.

The minimum applicable load is the N-level reference value. This value indicates the malfunction reference level for the reliability level of 60% ($\lambda 60$). The equation, $\lambda 60 = 0.5 \times 10^{-6} / \text{operations}$ indicates that the estimated malfunction rate is less than 1/2,000,000 operations with a reliability level of 60%.

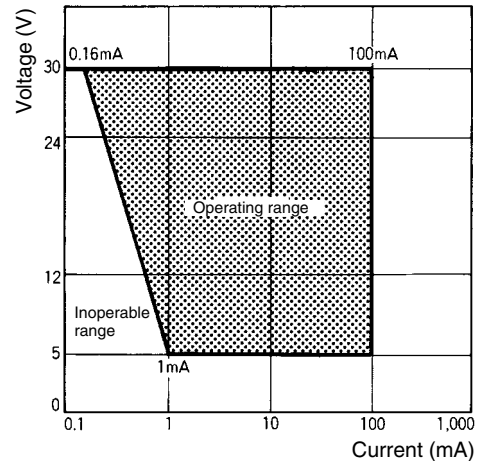

ALL DIMENSIONS SHOWN ARE IN MILLIMETERS.

To convert millimeters into inches, multiply by 0.03937. To convert grams into ounces, multiply by 0.03527.

Correct Use

No.	Area	No.	Item	Page
1	Using Switches			26
2	Selecting Correct Switch			
3	Electrical Conditions	1	Load	27
		2	Application of Switch to Electronic Circuits	
		3	Switches for Micro Loads	
		4	Contact Protective Circuit	
4	Mechanical Conditions	1	Operating Stroke Setting	28
		2	Switching Speed and Frequency	
		3	Operating Condition	
		4	Operating Method	
5	Mounting	1	Securing	29
		2	Terminal Connections	
		3	Soldering Precautions	
6	Operation and Storage Environment	1	Handling	30
		2	Operating Environment	
		3	Storage Environment	
7	Switch Trouble and Corrective Action			31

■ Using Switches

- When switches are actually used, unforeseen accidents may occur. Before using a switch, perform all possible testing in advance.
- Unless otherwise specified, ratings and performances given in this catalog are for standard test conditions (i.e., 15 to 35°C, 25% to 75% humidity, and 86 to 106 kPa atmospheric pressure). When performing testing in the actual application, always use the same conditions as will be used in actual usage conditions for both the load and the operating environment.
- Reference data provided in this catalog represents actual measurements from production samples in graph form. All reference data values are nominal.
- All ratings and performance values provided in this catalog are the results of a single test each rating and performance value therefore may not be met for composite conditions.

■ Selecting Correct Switch

Select an appropriate switch for the operating environment and load conditions.

- Use the *Selection Guide* to select a suitable switch for the rated current, operating load, actuator type, and operating environment.
- It is not recommended to use a switch for a large current to switch a micro current, in terms of contact reliability. Select a switch that is suitable for the current actually being switched.
- Use a sealed switch in environments subject to water, other liquids and excessive dirt or dust.

■ Electrical Conditions

Load

The switching capacity of a switch significantly differs depending on whether the switch is used to break an alternating current or a direct current. Be sure to check both the AC and DC ratings of a switch. The control capacity will drop drastically if it is a DC load. This is because a DC load, unlike an AC load, has no current zero cross point. Therefore, if an arc is generated, it may continue for a comparatively long time. Furthermore, the current direction is always the same, which results in contact relocation phenomena, and the contacts hold each other with ease and will not separate if the surfaces of the contacts are uneven.

If the load is inductive, counter-electromotive voltage will be generated. The higher the voltage is, the higher the generated energy is, which increase the abrasion of the contacts and contact relocation phenomena. Make sure to use a switch within the rated conditions.

If a switch is used for switching both micro and high-capacity loads, be sure to connect relays suitable to the loads.

The rated loads of a switch are according to the following conditions:

Inductive Load: A load having a minimum power factor of 0.4 (AC) or a maximum time constant of 7 ms (DC).

Lamp Load: A load having an inrush current ten times the steady-state current.

Motor Load: A load having an inrush current six times the steady-state current.

Note: It is important to know the time constant (L/R) of an inductive load in a DC circuit.

Inrush Current

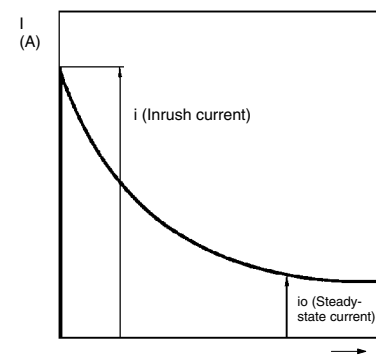

Application of Switch to Electronic Circuits

The Basic switch may have contact bouncing or chattering in switching, thus generating noise or pulse signals that may interfere the operation of electronic circuits or audio equipment. To prevent this, take the following countermeasures.

- Design the circuits so that they include appropriate CR circuits to absorb noise or pulse signals.
- Use switches with gold-plated contacts for micro loads, which are more resistive to environmental conditions.

Switches for Micro Loads

If a switch for a general load is used for switching a micro load, it may cause contact failures. Be sure to select a switch within the permissible range. Even if a switch for a micro load is used within the permissible range, the inrush current of the load may deteriorate the contacts, thus decreasing the durability of the switch. Therefore, if necessary, insert a proper contact protective circuit.

Contact Protective Circuit

Apply a contact protective circuit (surge killer) to extend contact durability, prevent noise, and suppress the generation of carbide or nitric acid due to arc. Be sure to apply the contact protective circuit properly, otherwise an adverse effect may result. Some typical examples of contact protective circuit are described in the following table.

When a switch is used under high humidity, arcs resulting from certain types of load (e.g., inductive loads) will generate nitrous oxides and, with mater the nitrous oxides will become nitric acid, which will corrode internal metal parts and may cause malfunctions. Always use a contact protective circuit according to information provided in the following table when using a switch under circuit conditions of frequent switching and arcing.

The use of a contact protective circuit may delay the response time of the load.

Typical Examples of Contact Protective Circuits (Surge Killers)

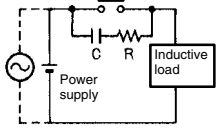
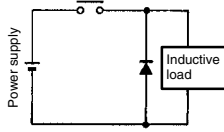
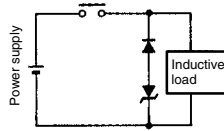
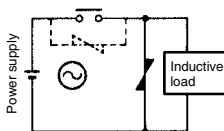
Circuit example	Applicable current		Feature	Element selection
	AC	DC		
CR circuit 	See note.	Yes	Note: When AC is switched, the load impedance must be lower than the C and R impedance. The operating time will increase if the load is a relay or solenoid. It is effective to connect the CR circuit in parallel to the load when the power supply voltage is 24 or 48 V and in parallel to the contacts when the power supply voltage is 100 to 200 V.	C: 0.5 to 1 μF per switching current (1 A) R: 0.5 to 1 Ω per switching voltage (1 V) The values may change according to the characteristics of the load. The capacitor suppresses the spark discharge of current when the contacts are open. The resistor limits the inrush current when the contacts are closed again. Consider these roles of the capacitor and resistor and determine the ideal capacitance and resistance values from experimentation. Use a capacitor with a dielectric strength between 200 and 300 V. When AC is switched, make sure that the capacitor has no polarity. If, however, the ability to control arcs between contacts is a problem for high DC voltage, it may be more effective to connect a capacitor and resistor between the contacts across the load. Check the results by testing in the actual application.
	Yes	Yes		
Diode method 	No	Yes	Energy stored in the coil is changed into current by the diode connected in parallel to the load. Then the current flowing to the coil is consumed and Joule heat is generated by the resistance of the inductive load. The reset time delay in this method is longer than that of the CR method.	The diode must withstand a peak inverse voltage 10 times higher than the circuit voltage and a forward current as high as or higher than the load current.
Diode and Zener diode method 	No	Yes	This method will be effective if the reset time delay caused by the diode method is too long.	Zener voltage for a Zener diode must be about 1.2 times higher than the power source since the load may not work under some circumstances.
Varistor method 	Yes	Yes	This method makes use of constant-voltage characteristic of the varistor so that no high-voltage is imposed on the contacts. This method causes a reset time delay more or less. It is effective to connect varistor in parallel to the load when the supply voltage is 24 to 48 V and in parallel to the contacts when the supply voltage is 100 to 200 V.	Select the varistor so that the following condition is met for the cut voltage Vc. For AC currents, the value must be multiplied by √2. $V_c > (\text{Current Voltage} \times 1.5)$ If Vc is set too high, however, the voltage cut for high voltages will no longer be effective, diminishing the effect.

Do not apply contact protective circuit as shown below.

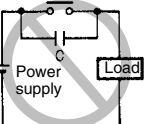
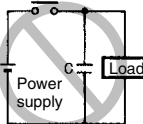
Incorrect 	This circuit effectively suppresses arcs when the contacts are OFF. The capacitance will be charged, however, when the contacts are OFF. Consequently, when the contacts are ON again, short-circuited current from the capacitance may cause contact weld.	Incorrect 	This circuit effectively suppresses arcs when the contacts are OFF. When the contacts are ON again, however, charge current flows to the capacitor, which may result in contact weld.
---	---	---	---

■ Mechanical Conditions

Operating Stroke Setting

The setting of stroke is very important for a switch to operate with high reliability.

The chart below shows the relationship among operating force, stroke, and contact force. To obtain high reliability from a switch, a switch actuator must be manipulated within an appropriate range of operating force.

Be sure to pay the utmost attention when mounting a switch.

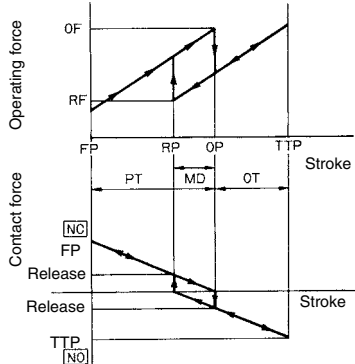

Make sure that the operating body is set so that the actuator should return to the free position when the operating body has moved if a switch is used to form a normally closed (NC) circuit. If a switch is used to form a normally open (NO) circuit, the operating body must move the switch actuator to the distance of 70% to 100% of the rated overtravel (OT) of the switch.

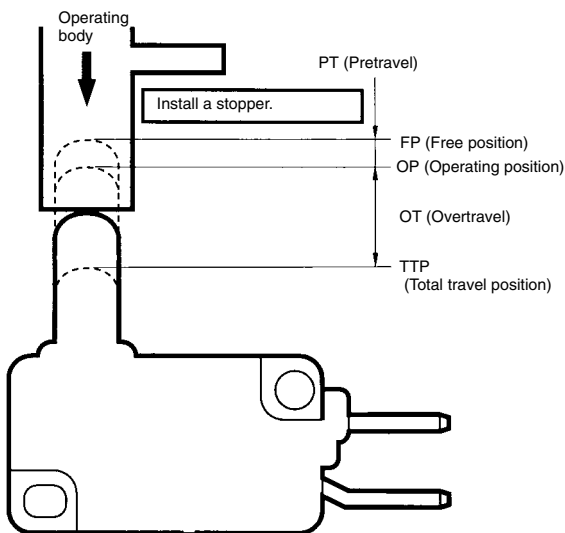

If stroke is set in the vicinity of the operating position (OP) or the releasing position (RP), contact force may become unstable. As a result, the switch cannot ensure high reliability. Furthermore, the switch may malfunction due to vibration or shock.

If stroke is set exceeding the total travel position (TTP), the moment of inertia of the operating body may damage the actuator or the switch itself, and the stress applied to the moving spring inside the switch will increase and then, the durability of the switch may be deteriorated.

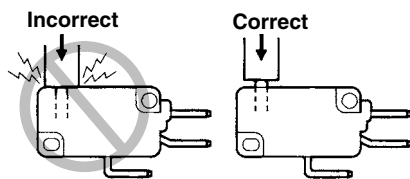

Switching Speed and Frequency

The switching frequency and speed of a switch have a great influence on the performance of the switch. Pay attention to the following.

- If the actuator is operated too slowly, the switching operation may become unstable, causing contact failures or contact welding.
- If the actuator is operated too quickly, the switch may be damaged by shock.
- If the switching frequency is too high, the switching of the contacts cannot catch up with the operating speed of the actuator.
- If the operating frequency is extremely low (i.e., once a month or less frequent), a film may be generated on the surface of the contacts, which may cause contact failures.

The permissible switching speed and switching frequency of a switch indicate the operational reliability of the switch. The durability of a switch is based on operation under specific conditions regarding the switching speed and switching frequency. The durability of a switch may not meet the durability due to conditions even if the switch is operated within the permissible switching speed and frequency ranges. Test a switch sample under the actual conditions to ascertain its durability.

Operating Condition

Do not leave a switch with the actuator depressed for a long time, otherwise the parts of the switch may soon deteriorate and the changes of its characteristics operating may result.

Operating Method

The operating method has a great influence on the performance of a switch. Consider the following before operating a switch.

- Design the operating body (i.e., cam or dog) so that it will operate the actuator smoothly. If the actuator snaps backwards quickly or receives shock due to the shape of the operating body, its durability may be deteriorated.

Incorrect

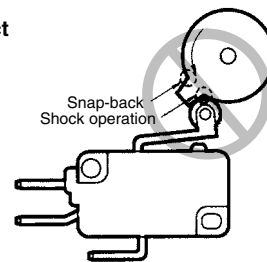

Correct

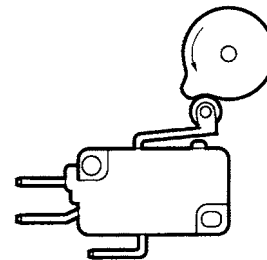

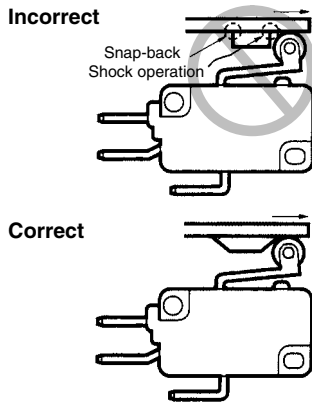

- Make sure that no improper force is applied to the actuator, otherwise the actuator may incur local abrasion. As a result, the actuator may become damaged or its durability may be deteriorated.

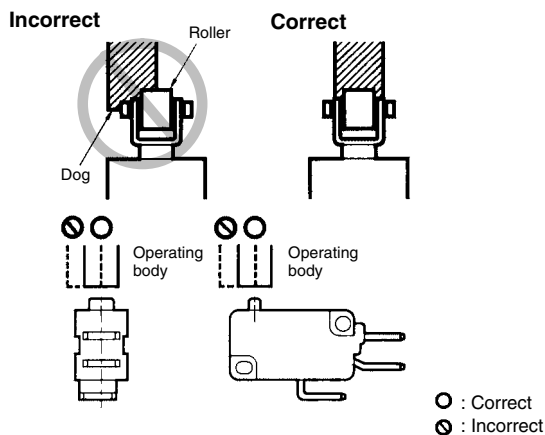

- Make sure that the operating body moves in a direction where the actuator moves. If the actuator is a pin plunger type, make sure that the operating body presses the pin plunger vertically.
- Operate the actuator of a hinge roller lever or simulated hinge lever type in the direction shown below.

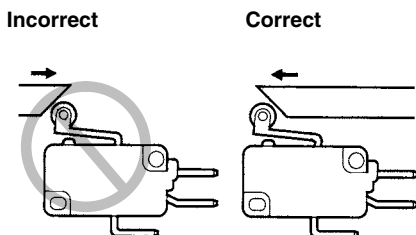

- Set the angle of the cam or dog (θ) for roller levers and similar actuators to the range between 30° and 45°. If the angle is too large, an abnormally large horizontal stress will be applied to the lever.

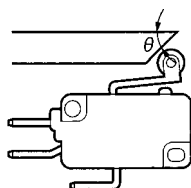

- Do not modify the actuator. If the actuator is modified, excessive external force may be applied to the internal switch mechanism, characteristics may change, and the switch may stop functioning.
- If an external actuator is used as an operating object, check the material and thickness of the lever to make sure that the force applied to the lever is within the permissible range.

■ Mounting

Securing

When mounting a switch, be sure to use the specified mounting screws and tighten the screws with flat washers or spring washers securely.

However, the switch housing may incur crack damage if it comes into contact with the spring washers directly. In that case make sure that the flat washers come into contact with the switch housing as shown below. Do not subject the switch to excessive shock or high-frequency vibrations when mounting (e.g., do not use an impact driver) as it may cause contacts stick or switch damage.

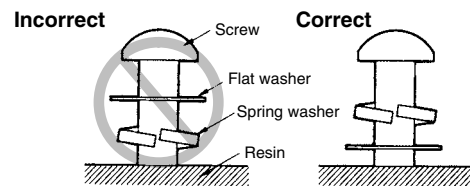

Do not modify the switch in any way, for example, by widening the mounting holes.

Locking Agent

If glue or locking agent is applied, make sure that it does not stick to the moving parts or intrude into the inside of the switch, otherwise the switch may have operating failure or contact failure. Some types of glue or locking agent may generate gas that has a bad influence on the switch. Pay the utmost attention when selecting glue or locking agent.

Wiring

Make sure that the lead wires are connected with no inappropriate pulling force.

Mounting Location

Be sure not to mount a switch in locations where the switch may be actuated by mistake.

Maintenance and Inspection

Make sure that a switch is mounted in locations that allow easy inspection or replacement of the switch.

Mounting Direction

When using a switch with a low operating force mounted with a long lever, make sure that the switch is mounted in the direction where the weight of the lever is not applied to the pushbutton directly, otherwise the switch may have releasing failures.

Terminal Connections

Solder Terminals

When soldering lead wires to a switch, make sure that the temperature of the iron tip is 380°C maximum. Improper soldering may cause abnormal heat radiation from the switch and the switch may burn.

Complete soldering within 5 seconds at 350°C or within 3 seconds at 380°C. If heat is applied for longer period of time, switch characteristics will be deteriorated, e.g., the case will melt and lead wire insulation will scorch.

Soldering conditions are even more strict for ultra subminiature switches. Refer to the *Precautions* for individual models for details.

Quick-Connect Terminals

Use the specified receptacles to connect to quick-connect terminals. Do not apply excessive force horizontally or vertically to the

terminals, otherwise the terminal may be deformed or the housing may be damaged.

Wiring Work

When wiring a switch, check the insulation distance between the switch and the mounting plate. If the insulation distance is insufficient, use an insulation guard or separator. Be particularly careful when mounting a switch to metal.

Use wire sizes suitable for the applied voltage and carrying current. Do not wire a switch while power is being supplied.

Using Separators

If providing sufficient insulation distance is a problem or there are metal components or copper wire near a switch, use a switch with an insulation guard or use a separator (order separately) to provide sufficient insulation distance.

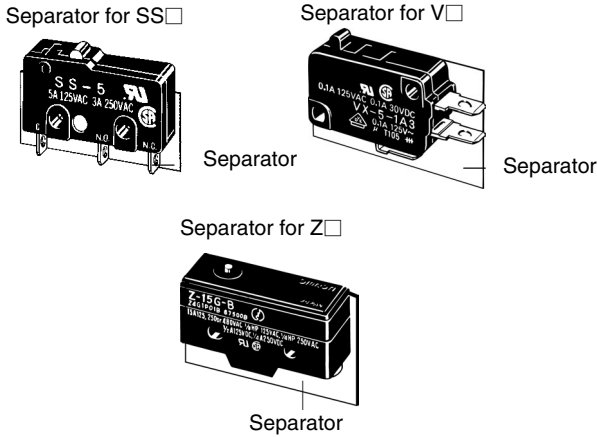

Soldering Precautions

When soldering by hand, place the terminal horizontal to the ground, use a soldering iron with a suitable heat capacity and a suitable amount of solder, and complete soldering quickly. Prevent flux from entering a switch by exhausting flux gas with an exhaust fan and by avoiding the contact of the tip of the soldering iron and the switch body. Flux gas inside a switch may cause contact failure. Do not apply any force to the terminal or wire immediately after soldering.

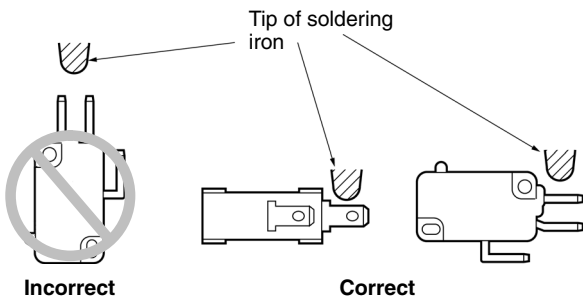

When soldering automatically, adjust the amount of solder so that flux does not float onto the top of PCB. If flux enters the switch, it can cause contact failure.

Operation and Storage Environment Handling

Do not apply oil, grease, or other lubricants to the sliding parts of a switch. The intrusion of oil, grease, or other lubricants into the internal part may cause operating failure or contact failure.

Operating Environment

A general switch is not water-resistant. Protect the switch appropriately when using the switch in places with water or oil spray.

Do not use a switch under the condition where vibration or shock is continuously applied to the switch. If continuous vibration or shock is applied to a switch, contact failure, malfunction, or decrease in durability may be caused by abrasive powder generated from the internal parts. If excessive vibration or shock is applied to a switch, the contacts may malfunction, stick, or be damaged.

Mount a switch in the location where vibration and shock is not applied to the switch and in the direction where they do not resonate.

Do not use a switch in the atmosphere of corrosive gas, such as sulfuric gas (H₂S or SO₂), ammonium gas (NH₃), nitric gas (HNO₃), or chlorine gas (Cl₂), or in the atmosphere of high temperature and humidity. Otherwise, contact failure or corrosion damage may result.

If a switch is used in the atmosphere of silicon gas, arc energy may attract silicon dioxide (SiO₂) to the contacts and contact failure may result. If there is silicon oil, silicon sealant, a wire covered with silicon, or any other silicon-based product near the switch, attach a contact protective circuit to suppress the arcing of the switch or eliminate the source of silicon gas generation. Even for a sealed switch, it may not be possible to prevent all of the gas from penetrating the seal rubber, and contact failure may result.

Be sure to use a switch at a temperature and humidity within the specified ranges. If a switch is exposed to radical temperature changes or intense heat, the characteristics of the switch may change. Separate the switch as far as possible from sources of heat to eliminate the influence.

Storage Environment

When storing a switch, consider countermeasures (e.g., storing in a plastic bag) to prevent discoloration resulting from sulfidization of terminals (silver-plated). Make sure that the location is free of corrosive gas or dust with no high temperature or humidity. It is recommended that a switch be inspected before use if it is stored for three months or more after the production, depending on the location.

Switch Trouble and Corrective Action

Type	Location of failure	Failure	Possible cause	Corrective action
Failures related to electrical characteristics	Contact	Contact failure	Dust and dirt on the contacts.	Remove the cause of the problem, place the switch in a box, or use a sealed switch.
			Water or other liquid has penetrated into a switch.	
			Chemical substances have been generated on the contact surface due to the atmosphere containing chemical corrosive gas.	Use a switch having contacts with high environmental resistivity (such as gold or alloy contacts).
			Chemical substances have been generated on the contact surface when the switch switches a very low load.	
			Solder flux has penetrated into the switch.	Review the soldering method or use a sealed or flux-tight switch.
			Silicon gas exists near the switch.	Remove the material generating gas, or adjust contact capacity to prevent formation of silicon compounds on the contacts.
	Malfunction	The contacts are separated from each other by vibration or shock.	Use a switch having a high contact force (generally a high OF).	
	Contact welding	The load connected to the switch is too high.	Switch the load with a high-capacity relay or magnetic relay or insert a contact protection circuit.	
	Insulation degradation (burning)	Contacts have been melted and scattered by arc.	Switch the load with a high-capacity relay or magnetic relay.	
		Water has penetrated into the switch because the switch has been used in an extremely hot environment.	Remove the cause of the problem, place the switch in a box, or use a sealed switch.	
Liquid has penetrated into the switch and been carbonized by arc heat.				
Failures related to mechanical characteristics	Actuator	Operating failure	The sliding part of the actuator has been damaged because an excessive force was applied on the actuator.	Make sure that no excessive force is applied to the actuator, or use an auxiliary actuator mechanically strong.
			Foreign material like dust, dirt and oil has penetrated into the switch.	Remove the cause of the problem or place the switch in a box.
			The actuator does not release because the operating body is too heavy.	Use a switch having a higher OF.
			The switch is loosely installed and thus does not operate even when the actuator is at the rated OP.	Secure the switch.
		Low durability	The shape of the dog or cam is improper.	Change the design of the dog or cam.
			The operating method is improper. The operating speed is too high.	Review the operating stroke and operating speed.
		Damage	A shock has been applied to the actuator.	Remove the cause of problem or use a switch mechanically strong.
	The caulked part is not good enough or the assembled condition is poor.		Replace the switch with a new one.	
	Deformation or drop-out Actuator was subjected to an excessive force and force from an inappropriate direction.		Review the handling and operating method.	
	Mounting section	Damage	Screws have not been inserted straight.	Check and correct screw insertion method.
			The mounting screws were tightened with too much torque.	Tighten the screws with an appropriate torque.
			The mounting pitch is wrong.	Correct the pitch.
			The switch is not installed on a flat surface.	Install the switch on a flat surface.
	Terminal	Damage	An excessive force was applied to the terminal while being wired.	Do not apply an excessive force.
			The plastic part has been deformed by soldering heat.	Reduce the soldering time or soldering temperature. (Refer to the information given under <i>Precautions</i> for that model.)