



Easy-to-Use, Low-Power, 1°C, Low-Supply TEMPERATURE RANGE MONITOR in MicroPackage

Check for Samples: [TMP303A](#)

FEATURES

- **LOW POWER:** 5µA (max)
- **SOT563 PACKAGE:** 1,6 x 1,6 x 0,6 mm
- **TRIP POINT ACCURACY:** ±0.2°C from –40°C to +125°C
- **PUSH-PULL OUTPUT**
- **SELECTABLE HYSTERESIS:** 1/2/5/10°C
- **SUPPLY VOLTAGE RANGE:** 1.4V to 3.6V

APPLICATIONS

- CELL PHONE HANDSETS
- PORTABLE MEDIA PLAYERS
- CONSUMER ELECTRONICS
- SERVERS
- POWER-SUPPLY SYSTEMS
- DC-DC MODULES
- THERMAL MONITORING
- ELECTRONIC PROTECTION SYSTEMS

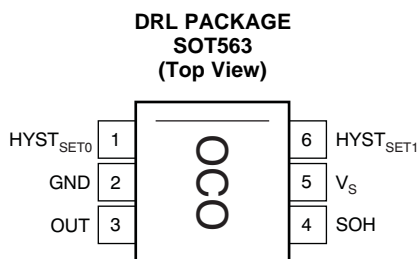

DESCRIPTION

The TMP303A is a temperature range monitor that offers design flexibility through its extra small footprint (SOT563), low power (5µA max) and low supply voltage capability (as low as 1.4V).

This device requires no additional components for operation; it can function independent of microprocessors or microcontrollers.

Trip points are preprogrammed at the factory. For applications that require different values, contact your local TI representative.

The OUT pin is a push-pull, active-high output. When the measured temperature is beyond the trip point range of 0°C to +60°C, and the Set Output High (SOH) pin is low, the OUT pin is high. The SOH pin is an input pin with an internal pulldown resistor. When the SOH pin is forced high, the OUT pin goes high regardless of the measured temperature.

TMP303A HYSTERESIS SETTINGS

HYST _{SET1}	HYST _{SET0}	HYSTERESIS (°C)
GND	GND	1
GND	V _S	2
V _S	GND	5
V _S	V _S	10

DEVICE SUMMARY

DEVICE	TRIP POINTS (°C)
TMP303A	T _L = 0, T _H = +60 ⁽¹⁾

(1) Contact TI representative for other trip points.



Please be aware that an important notice concerning availability, standard warranty, and use in critical applications of Texas Instruments semiconductor products and disclaimers thereto appears at the end of this data sheet.

All trademarks are the property of their respective owners.



This integrated circuit can be damaged by ESD. Texas Instruments recommends that all integrated circuits be handled with appropriate precautions. Failure to observe proper handling and installation procedures can cause damage.

ESD damage can range from subtle performance degradation to complete device failure. Precision integrated circuits may be more susceptible to damage because very small parametric changes could cause the device not to meet its published specifications.

PACKAGE INFORMATION⁽¹⁾

PRODUCT	PACKAGE	PACKAGE DESIGNATOR	PACKAGE MARKING
TMP303A	SOT563	DRL	OCO

(1) For the most current package and ordering information see the Package Option Addendum at the end of this document, or see the TI web site at www.ti.com.

ABSOLUTE MAXIMUM RATINGS⁽¹⁾

		TMP303A	UNIT
Supply Voltage, $V_S - GND$		+3.6	V
Input Pins, Voltage	SOH, HYST _{SET1} , HYST _{SET0}	-0.5 to $V_S + 0.5$	V
Output Pin, Voltage	OUT	-0.5 to $V_S + 0.5$	V
Output Pin, Current	OUT	8	mA
Operating Temperature Range		-55 to +130	°C
Storage Temperature Range		-60 to +150	°C
Junction Temperature (T_J max)		+150	°C
ESD Rating	Human Body Model (HBM)	2000	V
	Charged Device Model (CDM)	1000	V
	Machine Model (MM)	200	V

(1) Stresses above these ratings may cause permanent damage. Exposure to absolute maximum conditions for extended periods may degrade device reliability. These are stress ratings only, and functional operation of the device at these or any other conditions beyond those specified is not supported.

ELECTRICAL CHARACTERISTICS

 At $T_A = -40^\circ\text{C}$ to $+125^\circ\text{C}$ and $V_S = 1.4\text{V}$ to 3.6V , unless otherwise noted.

PARAMETER	CONDITIONS	TMP303A ⁽¹⁾			UNIT	
		MIN	TYP	MAX		
TEMPERATURE MEASUREMENT						
Trip Point Accuracy	$T_L = 0^\circ\text{C}, T_H = 60^\circ\text{C}, V_S = 3.3\text{V}$		± 0.2	± 1	$^\circ\text{C}$	
vs. Supply	$T_L = 0^\circ\text{C}, T_H = 60^\circ\text{C}, V_S = 1.4\text{V}$ to 3.6V		± 0.2	± 1.5	$^\circ\text{C}$	
Hysteresis	See Hysteresis Settings table on front page	1		10	$^\circ\text{C}$	
HYSTERESIS SET INPUT						
Input Logic Levels:						
V_{IH}		$0.7 \times V_S$		3.6	V	
V_{IL}		-0.5		$0.3 \times V_S$	V	
Input Current:						
I_{IN}	$0 < V_{IN} < 3.6\text{V}$			1	μA	
SOH INPUT						
Pulldown Resistor Value		80	100	120	k Ω	
Input Logic Levels:						
V_{IH}		$0.7 \times V_S$		3.6	V	
V_{IL}		-0.5		$0.3 \times V_S$	V	
Input Current	$V_{IN} = 3.6\text{V}$		36		μA	
OUTPUT						
Output Logic Levels						
V_{OH}	$V_S > 2\text{V}, I_{OH} = 0.5\text{mA}$	$V_S - 0.4$		V_S	V	
	$V_S < 2\text{V}, I_{OH} = 0.5\text{mA}$	$V_S - 0.2 \times (V_S)$		V_S	V	
V_{OL}	$V_S > 2\text{V}, I_{OL} = 1\text{mA}$	0		0.4	V	
	$V_S < 2\text{V}, I_{OL} = 1\text{mA}$	0		$0.2 \times V_S$	V	
POWER SUPPLY						
Specified Supply Voltage Range	V_S	1.4		3.6	V	
Power-up Start-up Time	$V_S > 1.4\text{V}$	20	28	35	ms	
Quiescent Current	I_Q		3.5	5	μA	
	$T_A = -55^\circ\text{C}$ to $+60^\circ\text{C}$		4	8	μA	
	$T_A = -40^\circ\text{C}$ to $+125^\circ\text{C}$					
TEMPERATURE RANGE						
Specified Range		-40		+125	$^\circ\text{C}$	
Operating Range		-55		+130	$^\circ\text{C}$	
Thermal Resistance, DRL	θ_{JA}	JEDEC Low-K Board			260	$^\circ\text{C}/\text{W}$

 (1) 100% of all units are production tested at $T_A = +25^\circ\text{C}$. Over temperature specifications are specified by design.

TYPICAL CHARACTERISTICS

At $V_S = +3.3V$ and $T_A = +25^\circ C$, unless otherwise noted.

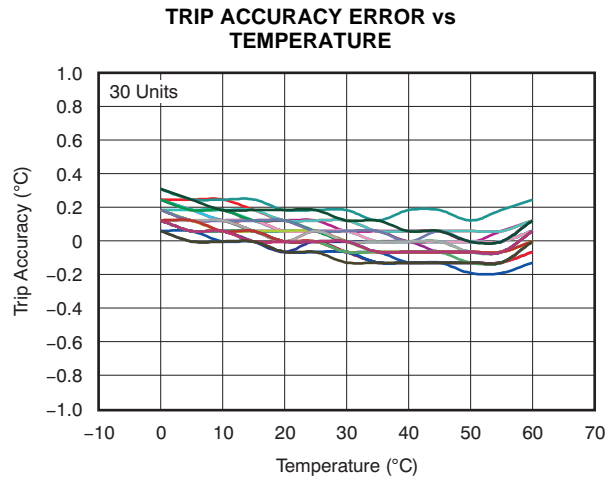

Figure 1.

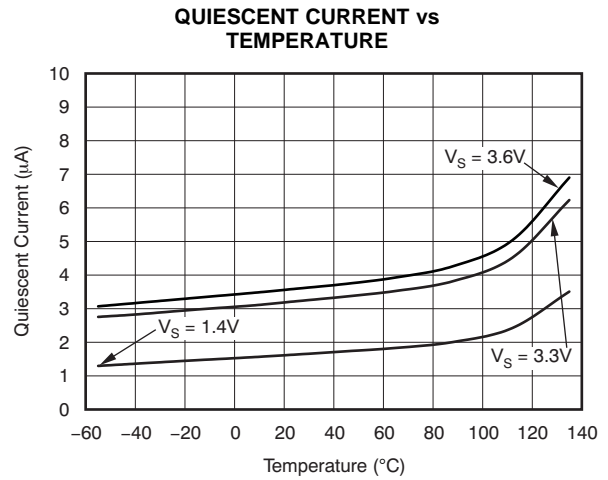

Figure 2.

TEMPERATURE STEP RESPONSE IN PERFLUORINATED FLUID AT +100°C vs TIME

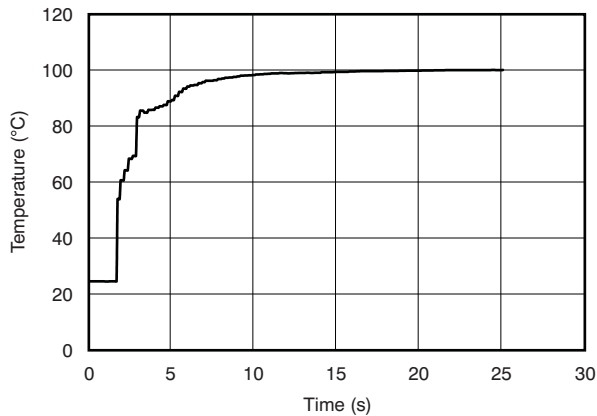

Figure 3.

THERMAL STEP RESPONSE IN AIR AT +100°C vs TIME

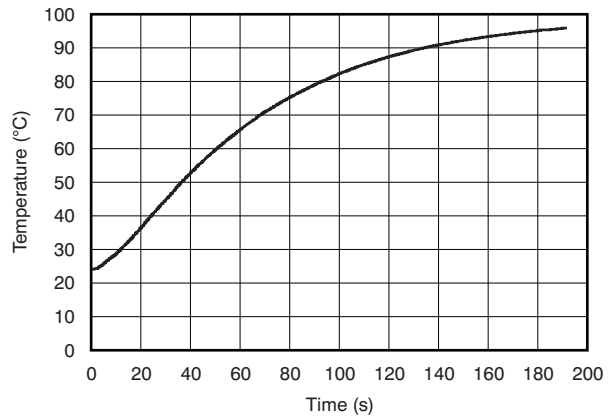

Figure 4.

TRIP THRESHOLD ACCURACY

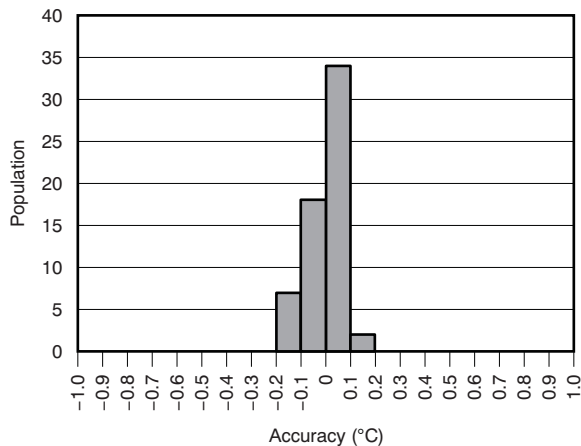

Figure 5.

POWER-UP AND POWER-DOWN TRANSIENT RESPONSE

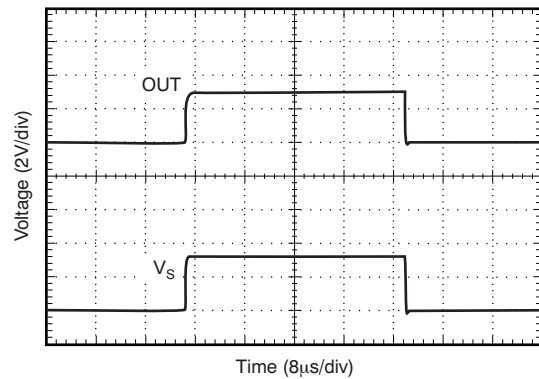

Figure 6.

TYPICAL CHARACTERISTICS (continued)

At $V_S = +3.3V$ and $T_A = +25^\circ C$, unless otherwise noted.

POWER-UP, TRIP, AND POWER-DOWN RESPONSE

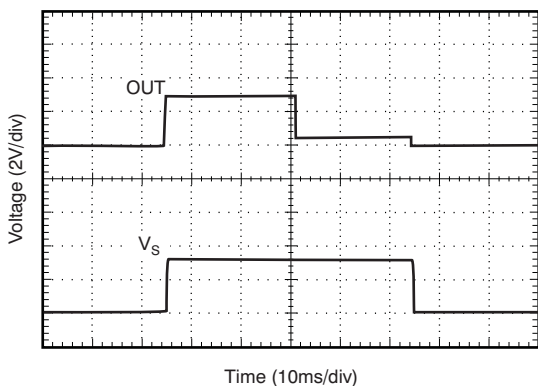

Figure 7.

OUTPUT LOGIC LEVEL LOW vs TEMPERATURE

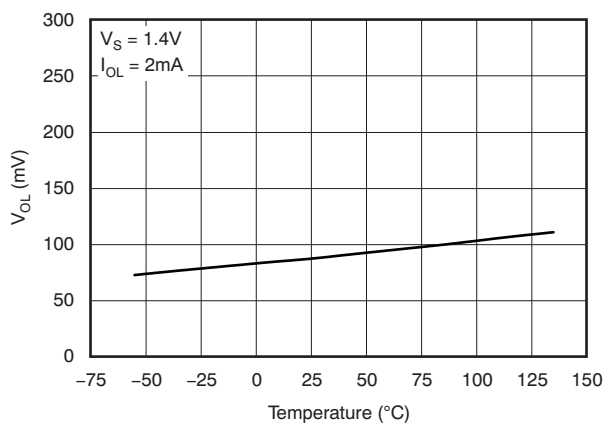

Figure 8.

OUTPUT LOGIC LEVEL HIGH vs TEMPERATURE

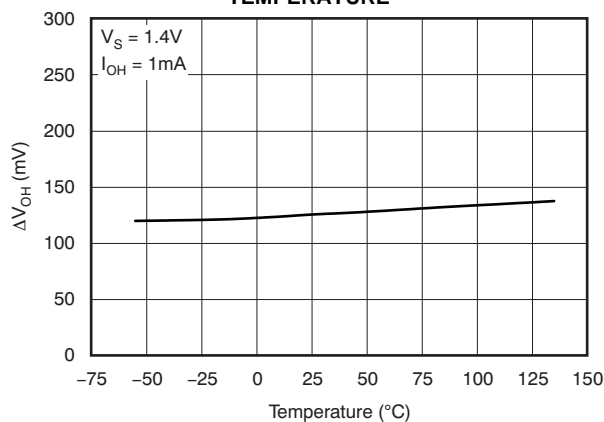

Figure 9.

APPLICATION INFORMATION

The TMP303A is a temperature switch used in battery-powered applications that require accurate monitoring of a very specific temperature range of 0°C to +60°C. This functionality is accomplished through the preset trip window and two hysteresis bits, HYST_{SET0} and HYST_{SET1}. The preset trip window temperature thresholds are configured at the factory; for other trip points, contact a TI representative. Table 1 summarizes the bit setting versus hysteresis temperature window.

Table 1. Bit Setting vs Hysteresis Window

HYST _{SET1}	HYST _{SET0}	HYSTERESIS
GND	GND	1°C
GND	V _S	2°C
V _S	GND	5°C
V _S	V _S	10°C

Configuring the TMP303A

The TMP303A contains an active high, *push-pull* output stage and does not require a pull-up resistor to V_S for proper operation. Figure 10 shows a block diagram of the TMP303A.

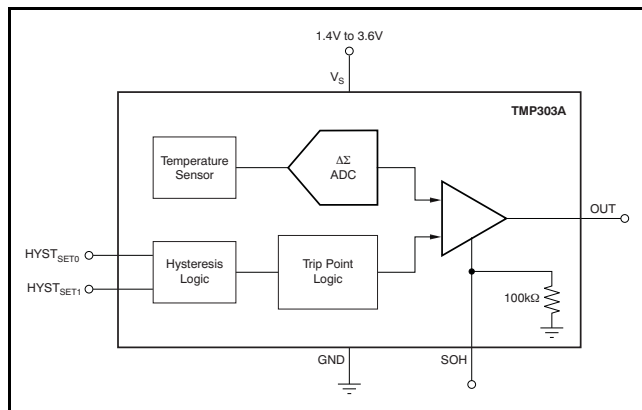

Figure 10. TMP303A Block Diagram

Power-supply bypassing is strongly recommended; use a 0.1μF capacitor placed as close as possible to the supply pin.

The TMP303A temperature trip window resides within the range of 0°C to 60°C. When either of these trip thresholds is crossed, the output (OUT) changes state from low to high. OUT does not return to its original low state until the temperature crosses the hysteresis threshold and returns within the range of the 0°C to 60°C window.

As an example, if the TMP303A is configured with a 10°C hysteresis window (that is, HYST_{SET0} = HYST_{SET1} = V_S), the output does not return to its low state until the temperature either crosses (T_L + hysteresis) = 10°C or (T_H - hysteresis) = 50°C. The Set Output High (SOH) pin is intended to add test functionality to verify the connectivity of the output (OUT) pin to the system controller or other temperature response system. The SOH pin is internally pulled down to ground with a 100kΩ resistor. If the SOH pin is grounded or left floating, it has no effect on the behavior of the TMP303A. If the SOH pin is pulled high, the TMP303A immediately forces the output high, regardless of temperature. It is very important to note that this response occurs even if the temperature falls within the 0°C to 60°C temperature window. Figure 11 illustrates this design in graphical form.

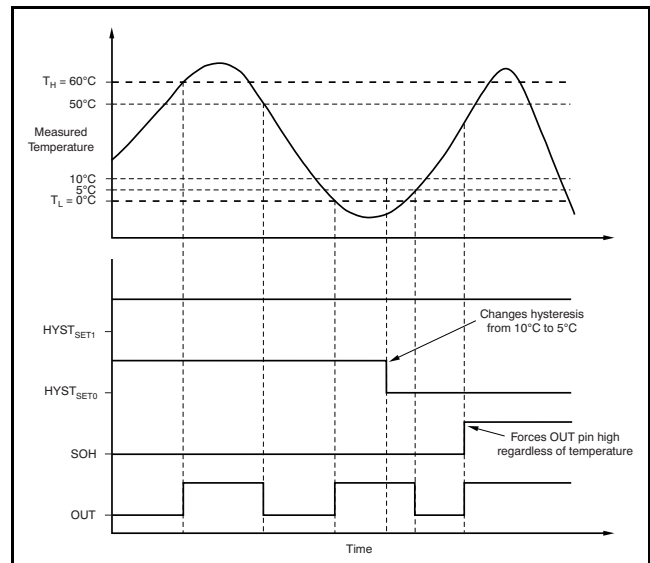

Figure 11. Output Transfer Curves with Hysteresis Change from 10°C to 5°C and SOH Functionality

TMP303A Power Up and Timing

At device power-up, the TMP303A exerts $OUT = \text{high}$, and typically requires 26ms to return to a low state only if the temperature falls within the hysteresis window set by $HYST_{SET0}$ and $HYST_{SET1}$.

The tolerance of the thermal response time is largely a result of the differences in conversion time, which varies between 20ms and 35ms; likewise, this conversion does not take place after a power cycle until the supply voltage has reached a level of at least 1.4V. This sequence is illustrated in Figure 12.

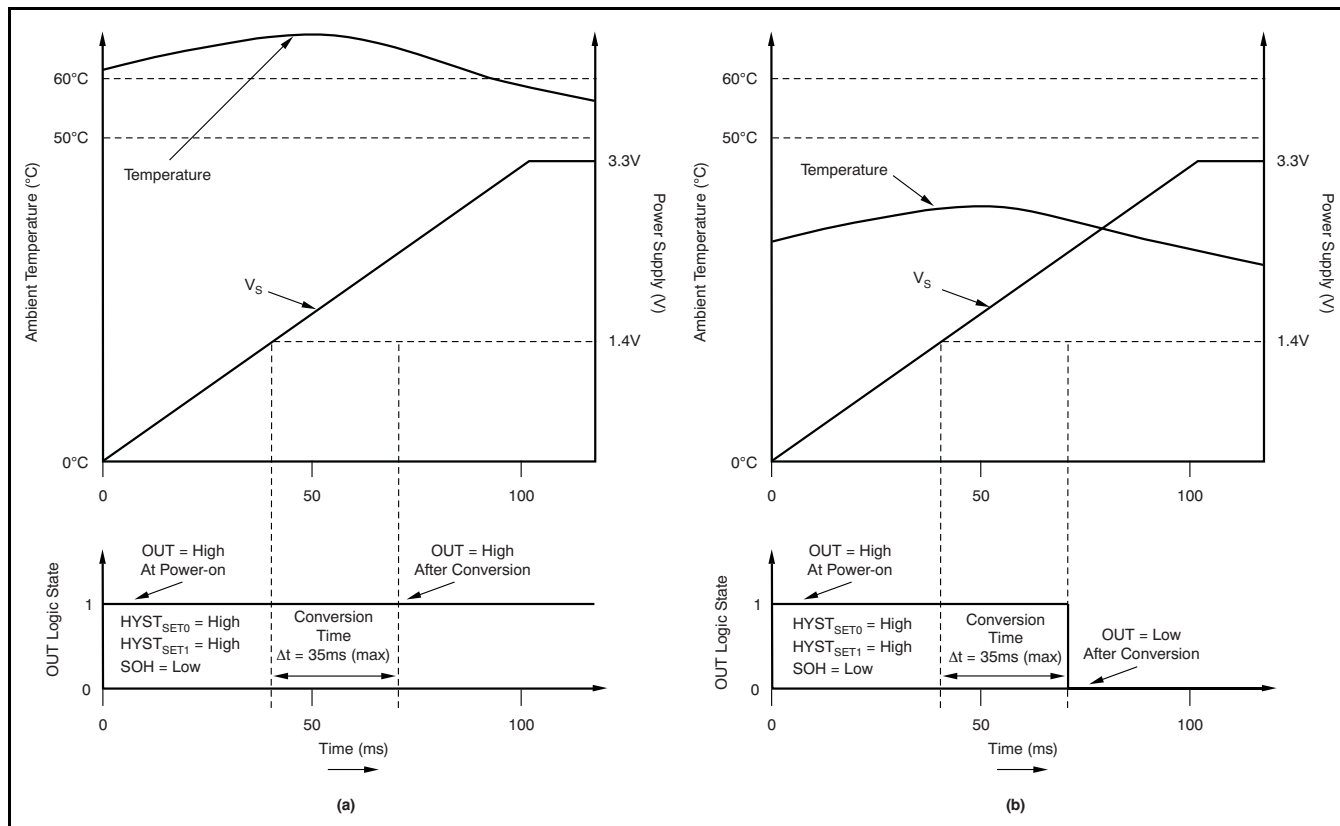

Figure 12. Start-Up Delay vs. Output Voltage ($HYST_{SET0} = HYST_{SET1} = V_S$)

After the TMP303A powers up, all successive thermal response results for the device are achieved in a time frame of 0.985s to 1s. This period is the minimum time frame required for the push-pull output (OUT) to change its state from high to low (or vice-versa) while the device is active.

A maximum low output voltage is defined as a voltage level equivalent to $(0.2 \times V_S)$; likewise, a minimum high output voltage is defined as $(0.8 \times V_S)$. The timing associated with start-up time and conversion is shown in Figure 13.

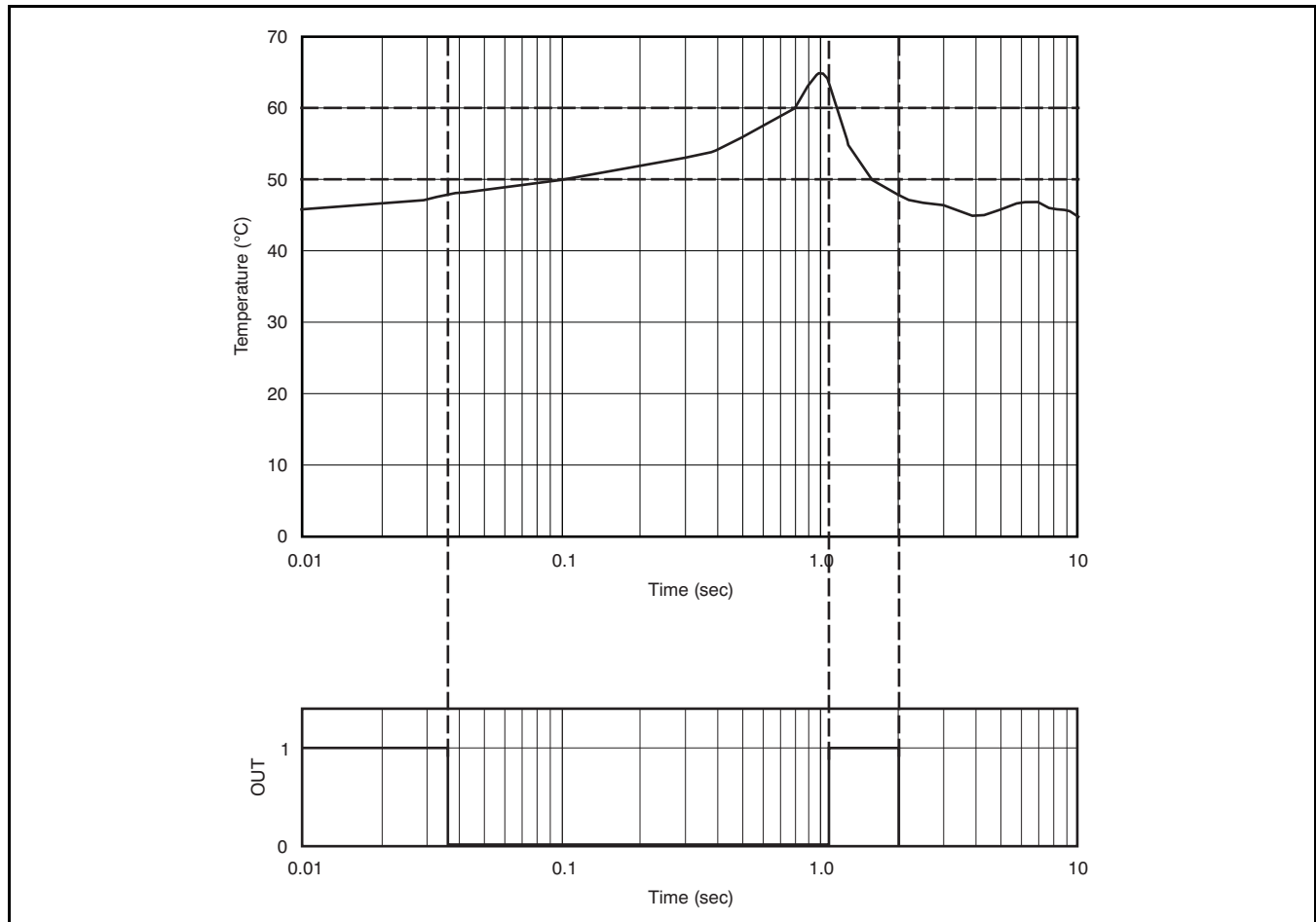

Figure 13. TMP303A Start-Up and Conversion Timing ($HYST_{SET0} = HYST_{SET1} = V_S$)

PACKAGING INFORMATION

Orderable Device	Status ⁽¹⁾	Package Type	Package Drawing	Pins	Package Qty	Eco Plan ⁽²⁾	Lead/Ball Finish	MSL Peak Temp ⁽³⁾
TMP303ADRLR	ACTIVE	SOT	DRL	6	4000	Green (RoHS & no Sb/Br)	CU NIPDAU	Level-1-260C-UNLIM
TMP303ADRLT	ACTIVE	SOT	DRL	6	250	Green (RoHS & no Sb/Br)	CU NIPDAU	Level-1-260C-UNLIM

⁽¹⁾ The marketing status values are defined as follows:

ACTIVE: Product device recommended for new designs.

LIFEBUY: TI has announced that the device will be discontinued, and a lifetime-buy period is in effect.

NRND: Not recommended for new designs. Device is in production to support existing customers, but TI does not recommend using this part in a new design.

PREVIEW: Device has been announced but is not in production. Samples may or may not be available.

OBsolete: TI has discontinued the production of the device.

⁽²⁾ Eco Plan - The planned eco-friendly classification: Pb-Free (RoHS), Pb-Free (RoHS Exempt), or Green (RoHS & no Sb/Br) - please check <http://www.ti.com/productcontent> for the latest availability information and additional product content details.

TBD: The Pb-Free/Green conversion plan has not been defined.

Pb-Free (RoHS): TI's terms "Lead-Free" or "Pb-Free" mean semiconductor products that are compatible with the current RoHS requirements for all 6 substances, including the requirement that lead not exceed 0.1% by weight in homogeneous materials. Where designed to be soldered at high temperatures, TI Pb-Free products are suitable for use in specified lead-free processes.

Pb-Free (RoHS Exempt): This component has a RoHS exemption for either 1) lead-based flip-chip solder bumps used between the die and package, or 2) lead-based die adhesive used between the die and leadframe. The component is otherwise considered Pb-Free (RoHS compatible) as defined above.

Green (RoHS & no Sb/Br): TI defines "Green" to mean Pb-Free (RoHS compatible), and free of Bromine (Br) and Antimony (Sb) based flame retardants (Br or Sb do not exceed 0.1% by weight in homogeneous material)

⁽³⁾ MSL, Peak Temp. -- The Moisture Sensitivity Level rating according to the JEDEC industry standard classifications, and peak solder temperature.

Important Information and Disclaimer:The information provided on this page represents TI's knowledge and belief as of the date that it is provided. TI bases its knowledge and belief on information provided by third parties, and makes no representation or warranty as to the accuracy of such information. Efforts are underway to better integrate information from third parties. TI has taken and continues to take reasonable steps to provide representative and accurate information but may not have conducted destructive testing or chemical analysis on incoming materials and chemicals. TI and TI suppliers consider certain information to be proprietary, and thus CAS numbers and other limited information may not be available for release.

In no event shall TI's liability arising out of such information exceed the total purchase price of the TI part(s) at issue in this document sold by TI to Customer on an annual basis.

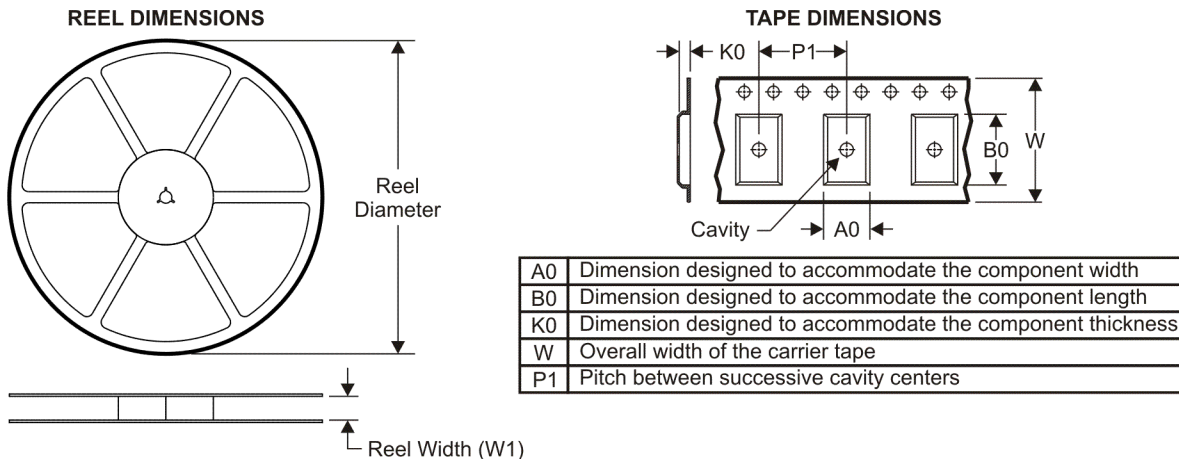
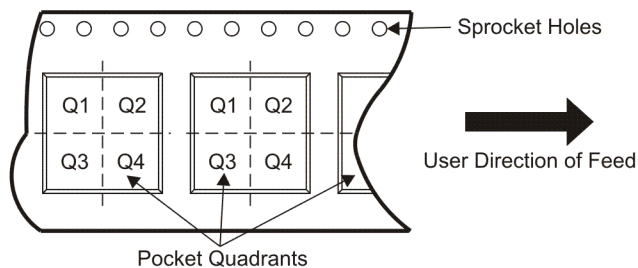
TAPE AND REEL INFORMATION

QUADRANT ASSIGNMENTS FOR PIN 1 ORIENTATION IN TAPE

*All dimensions are nominal

Device	Package Type	Package Drawing	Pins	SPQ	Reel Diameter (mm)	Reel Width W1 (mm)	A0 (mm)	B0 (mm)	K0 (mm)	P1 (mm)	W (mm)	Pin1 Quadrant
TMP303ADRLR	SOT	DRL	6	4000	180.0	8.4	1.78	1.78	0.69	4.0	8.0	Q3
TMP303ADRLT	SOT	DRL	6	250	180.0	8.4	1.78	1.78	0.69	4.0	8.0	Q3

TAPE AND REEL BOX DIMENSIONS

*All dimensions are nominal

Device	Package Type	Package Drawing	Pins	SPQ	Length (mm)	Width (mm)	Height (mm)
TMP303ADRLR	SOT	DRL	6	4000	202.0	201.0	28.0
TMP303ADRLT	SOT	DRL	6	250	202.0	201.0	28.0

DRL (R-PDSO-N6)

PLASTIC SMALL OUTLINE

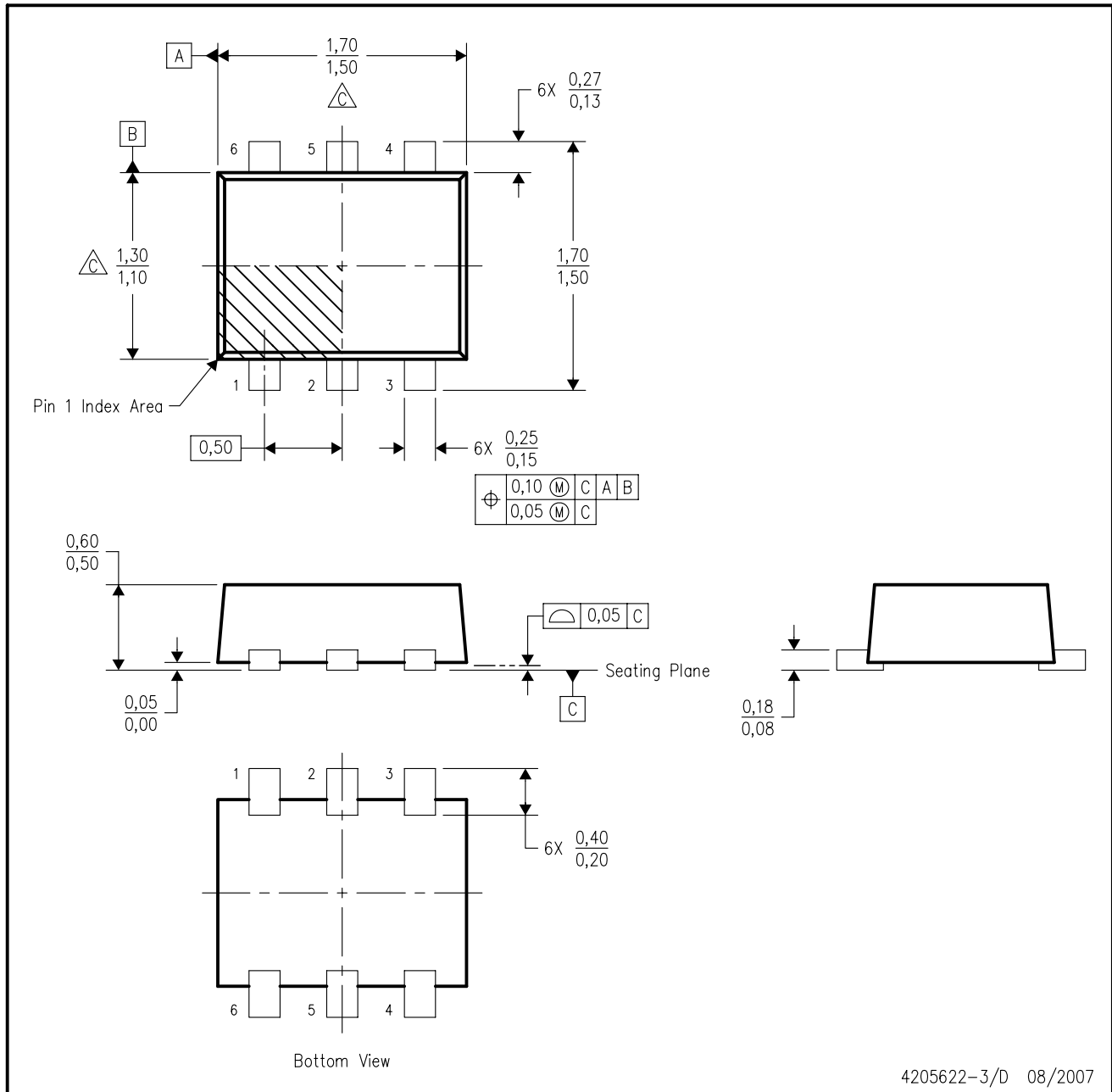

- NOTES:
- A. All linear dimensions are in millimeters. Dimensioning and tolerancing per ASME Y14.5M-1994.
 - B. This drawing is subject to change without notice.
 - C. Body dimensions do not include mold flash, interlead flash, protrusions, or gate burrs. Mold flash, interlead flash, protrusions, or gate burrs shall not exceed 0,15 per end or side.
 - D. JEDEC package registration is pending.

DRL (R-PDSO-N6)

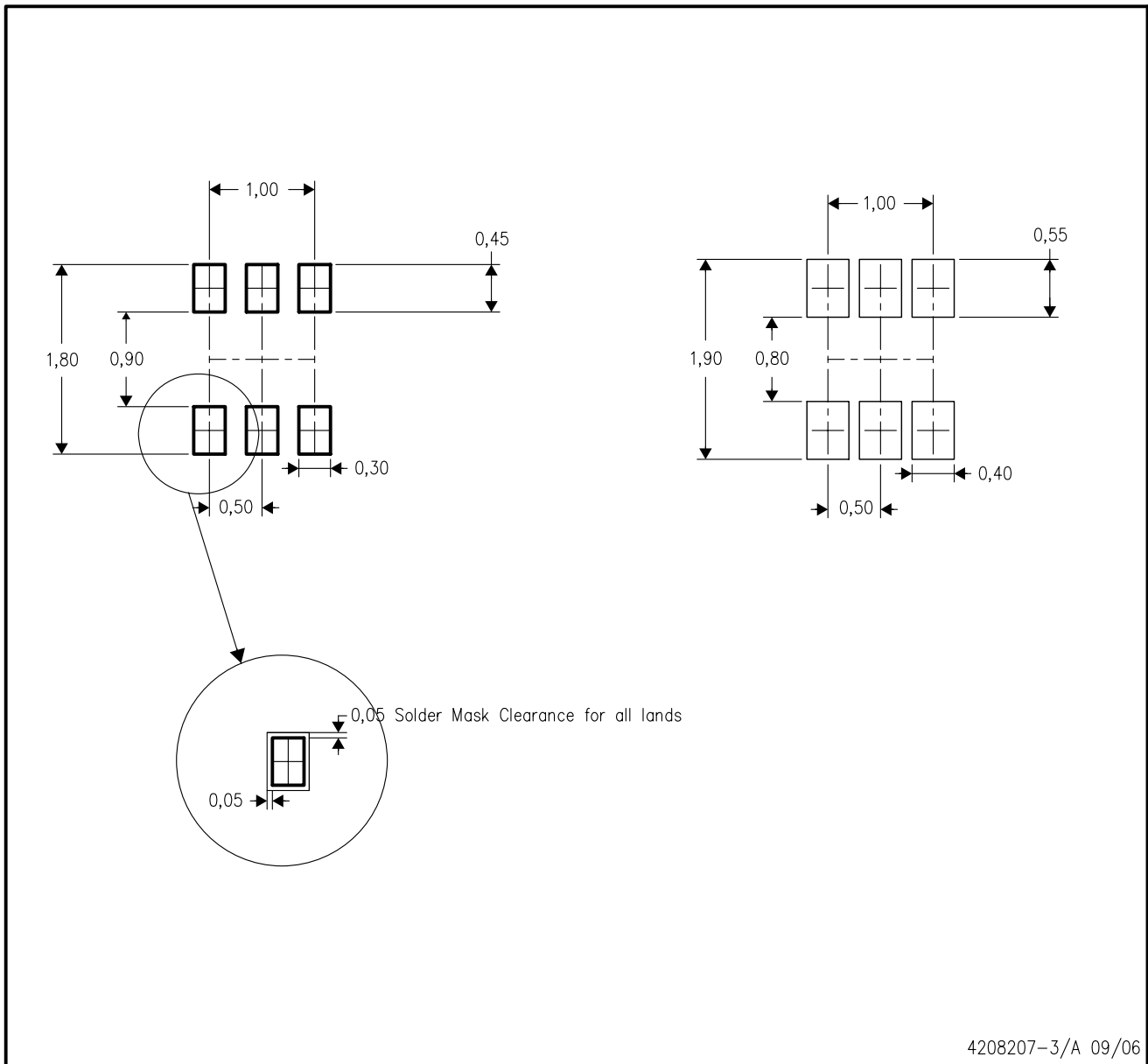

- NOTES:
- A. All linear dimensions are in millimeters.
 - B. This drawing is subject to change without notice.
 - C. Publication IPC-7351 is recommended for alternate designs.
 - D. Customers should contact their board fabrication site for minimum solder mask web tolerances between signal pads.
 - E. Maximum stencil thickness 0,127 mm (5 mils). All linear dimensions are in millimeters.
 - F. Laser cutting apertures with trapezoidal walls and also rounding corners will offer better paste release. Customers should contact their board assembly site for stencil design recommendations. Refer to IPC 7525 for stencil design considerations.
 - G. Side aperture dimensions over-print land for acceptable area ratio > 0.66. Customer may reduce side aperture dimensions if stencil manufacturing process allows for sufficient release at smaller opening.

IMPORTANT NOTICE

Texas Instruments Incorporated and its subsidiaries (TI) reserve the right to make corrections, modifications, enhancements, improvements, and other changes to its products and services at any time and to discontinue any product or service without notice. Customers should obtain the latest relevant information before placing orders and should verify that such information is current and complete. All products are sold subject to TI's terms and conditions of sale supplied at the time of order acknowledgment.

TI warrants performance of its hardware products to the specifications applicable at the time of sale in accordance with TI's standard warranty. Testing and other quality control techniques are used to the extent TI deems necessary to support this warranty. Except where mandated by government requirements, testing of all parameters of each product is not necessarily performed.

TI assumes no liability for applications assistance or customer product design. Customers are responsible for their products and applications using TI components. To minimize the risks associated with customer products and applications, customers should provide adequate design and operating safeguards.

TI does not warrant or represent that any license, either express or implied, is granted under any TI patent right, copyright, mask work right, or other TI intellectual property right relating to any combination, machine, or process in which TI products or services are used. Information published by TI regarding third-party products or services does not constitute a license from TI to use such products or services or a warranty or endorsement thereof. Use of such information may require a license from a third party under the patents or other intellectual property of the third party, or a license from TI under the patents or other intellectual property of TI.

Reproduction of TI information in TI data books or data sheets is permissible only if reproduction is without alteration and is accompanied by all associated warranties, conditions, limitations, and notices. Reproduction of this information with alteration is an unfair and deceptive business practice. TI is not responsible or liable for such altered documentation. Information of third parties may be subject to additional restrictions.

Resale of TI products or services with statements different from or beyond the parameters stated by TI for that product or service voids all express and any implied warranties for the associated TI product or service and is an unfair and deceptive business practice. TI is not responsible or liable for any such statements.

TI products are not authorized for use in safety-critical applications (such as life support) where a failure of the TI product would reasonably be expected to cause severe personal injury or death, unless officers of the parties have executed an agreement specifically governing such use. Buyers represent that they have all necessary expertise in the safety and regulatory ramifications of their applications, and acknowledge and agree that they are solely responsible for all legal, regulatory and safety-related requirements concerning their products and any use of TI products in such safety-critical applications, notwithstanding any applications-related information or support that may be provided by TI. Further, Buyers must fully indemnify TI and its representatives against any damages arising out of the use of TI products in such safety-critical applications.

TI products are neither designed nor intended for use in military/aerospace applications or environments unless the TI products are specifically designated by TI as military-grade or "enhanced plastic." Only products designated by TI as military-grade meet military specifications. Buyers acknowledge and agree that any such use of TI products which TI has not designated as military-grade is solely at the Buyer's risk, and that they are solely responsible for compliance with all legal and regulatory requirements in connection with such use.

TI products are neither designed nor intended for use in automotive applications or environments unless the specific TI products are designated by TI as compliant with ISO/TS 16949 requirements. Buyers acknowledge and agree that, if they use any non-designated products in automotive applications, TI will not be responsible for any failure to meet such requirements.

Following are URLs where you can obtain information on other Texas Instruments products and application solutions:

Products		Applications	
Amplifiers	amplifier.ti.com	Audio	www.ti.com/audio
Data Converters	dataconverter.ti.com	Automotive	www.ti.com/automotive
DLP® Products	www.dlp.com	Communications and Telecom	www.ti.com/communications
DSP	dsp.ti.com	Computers and Peripherals	www.ti.com/computers
Clocks and Timers	www.ti.com/clocks	Consumer Electronics	www.ti.com/consumer-apps
Interface	interface.ti.com	Energy	www.ti.com/energy
Logic	logic.ti.com	Industrial	www.ti.com/industrial
Power Mgmt	power.ti.com	Medical	www.ti.com/medical
Microcontrollers	microcontroller.ti.com	Security	www.ti.com/security
RFID	www.ti-rfid.com	Space, Avionics & Defense	www.ti.com/space-avionics-defense
RF/IF and ZigBee® Solutions	www.ti.com/lprf	Video and Imaging	www.ti.com/video
		Wireless	www.ti.com/wireless-apps