

249 701

# Alarm Sounders

## Low Profile Polarised Banshee Part No 249701

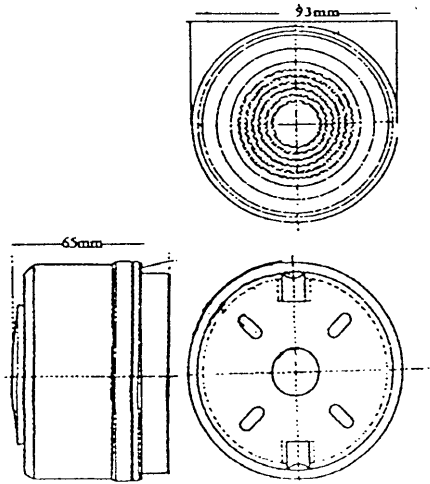

General purpose multi frequency alarm sander, suitable for alarm line monitoring applications, where the polarity of supply is "reversed" to provide wiring continuity status or "Normal" to operate. The sander frequency and output level may be set at installation.

Two sounds are available by the use of a third wire at installation as follows:

- Select either fast sweep 9 times per second or slow sweep 3 times per second via jumper setting.
- Connect the two supply wires to appropriate terminals.
- Connect the third wire to the terminal label "CONT O'RIDE" for sweeping sound. Alternatively connect the third wire to 0V for continuous tone.

## Standard Bi-Polar Banshee Part No 143036

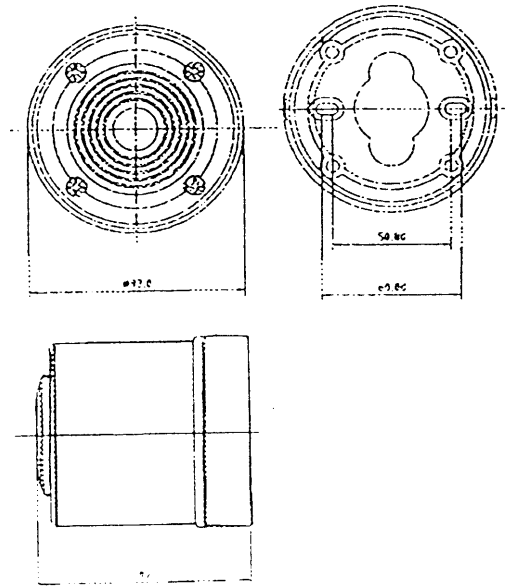

General purpose alarm sander, offering a choice of four different sounds unaffected by supply polarity.

Dual sounds are available with a two wire configuration as follows:

- Select either fast sweep 9 times per second or slow sweep 3 times per second.
- Connect the CONT O'RIDE terminal to the COMMON terminal.
- Connect the supply to the COMMON and the appropriate supply terminal. Selected sounds can be alternated by revering the supply polarity.

This sander can be operated either with unregulated D.C. or low voltage A.C. supply.

## Technical Data

Description	Part No 249701	Part No 143036	Description	Part No 249701	Part No 143036
Op Voltage	12/24 Volts Dc	12/24 Volts Dc	Current	25 MA	25 MA
Op Temp	-40 to +70° C	-40 to +70° C	Connection	Screw Terminal Block	Screw Terminal Block
Output Level (at 1meter)	Max 100 dBA Min 68 dBA	Typical 100 dBA	Sound Type	Buzz Sweep 120Hz Fast Sweep 2.4-2.9kHz Slow Sweep 2.4-2.9kHz Continuous 2.6kHz	Buzz Sweep 120Hz Fast Sweep 2.5-3kHz Slow Sweep 2.5-3kHz Continuous 2.7kHz
Dimensions	Height 65 mm Diameter 93 mm	Height 97 mm Diameter 93mm	Sound Sweep	Fast 9 times per second Slow 3 times per second	Fast 9 times per second Slow 3 times per second