

A photograph showing a hand on the left side, with the index finger pointing towards the right. The background is a dark blue gradient with several bright, curved light trails that sweep across the frame from left to right, creating a sense of motion and technology.

## CY3218-CAEXP2 CapSense™ Express Evaluation Kit Quick Start

Doc. # 001-44863 Rev. \*A

Cypress Semiconductor  
198 Champion Court  
San Jose, CA 95134-1709  
Phone (USA): 800.858.1810  
Phone (Intnl): 408.943.2600  
<http://www.cypress.com>

# Getting Started

1. [Review Kit Contents](#)
2. [Explore the Board](#)
3. [Install Software](#)
4. [CY3218-CAPEXP2 Board Features](#)
5. [Tune the CY3218-CAPEXP2 CapSense Express Board](#)
6. [Create a CY3218-CAPEXP2 CapSense Express Project](#)
7. [Additional CapSense Resources](#)

## 1. Review Kit Contents

Each CY3218-CAPEXP2 CapSense Express Demonstration Kit contains:

- CY3218-CAPEXP2 CapSense Express Demonstration Board
- Kit CD, which includes:
  - PSoC Programmer
  - .NET Framework 2.0 (for Windows 2000 and Windows XP)
  - PSoC Express 3
  - CapSense Express Extension Pack
  - CapSense Express Kit Documentation
- Retractable USB Cable (A to Mini-B)
- PSoC CY3240-I2USB Bridge Board
- AAA Battery

## 2. Explore the Board

**Caution: Do not touch the board anywhere other than the edges or the buttons.** Touching the board in the wrong area could lead to a short and an unresponsive board. If this happens, follow the instructions in Section 2 to reset the power to the board.

- 2.1. Insert the AAA battery into the battery holder on the back of the board.
- 2.2. Remove the jumper from J2 (back of board, left side, center).
- 2.3. Slide your finger across the slider. Notice how the LEDs illuminate in a clockwise direction as you move your finger from the left to the right across the slider.
- 2.4. Press the mechanical button at the bottom of the board. All four LEDs light up.
- 2.5. Turn the board off by replacing the jumper on J2. Note that replacing the jumper disables battery operation.

## 3. Install Software

### Install PSoC Express Development Software

- 3.1. Insert the Kit CD, wait for the installer to start, and install the following software in the order listed:
  - a. Install PSoC Programmer.
  - b. Install .NET Framework 2.0.
  - c. Install PSoC Express 3.
  - d. Install CapSense Express Extension Pack.
  - e. Install CapSense Express Kit Documentation.

## 4. CY3218-CAPEXP2 Board Features

- One 5-Segment CapSense Slider
- 4 Status LEDs (Green)
- 1 Power LED (Red)
- 1 Mechanical Switch
- I<sup>2</sup>C Header
- AAA Battery Holder

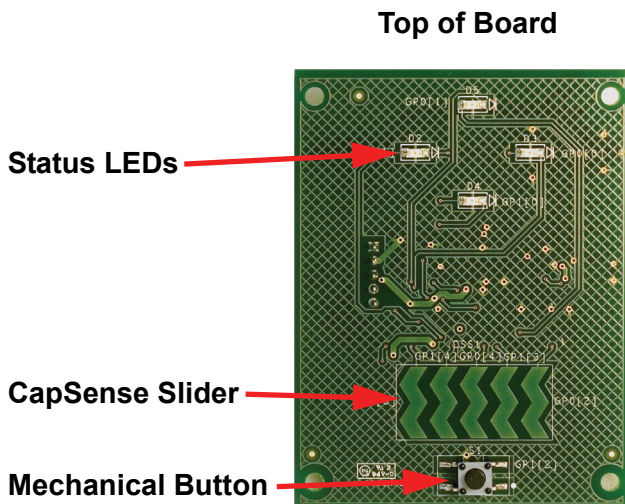

Use the CY3218-CAPEXP2 Evaluation Kit to evaluate the CapSense slider, LED drive, digital input, and I2C features of the CapSense Express device. Via the CapSense Express Configuration Tool in PSoC Express, the four status LEDs can be controlled by the CapSense slider and the mechanical button. The CapSense Express device mounted on the board is in the 16-QFN package. The board is powered with a AAA battery mounted in the battery holder. A boost converter converts the input voltage in the range of 0.9V-1.5V to the device operating voltage of 3.3V. The board can also be powered using an I2C to USB bridge connected to the I2C header.

# 5. Tune the CY3218-CAPEXP2 CapSense Express Board

## Functional Description

When a finger moves along the capacitive slider, corresponding LEDs are lit in a circular progression. Additionally, pressing the pushbutton switch causes all of the LEDs to be lit.

## Tuning Steps

- 5.1. Connect your computer to the CapSense test board ISSP Connector (J5)  using the CY3240-I2USB Bridge Board and a USB cable. When connected correctly, the USB connector on the CY3240-I2USB Bridge Board is visible when viewing the front of the CY3218-CAPEXP2 board.

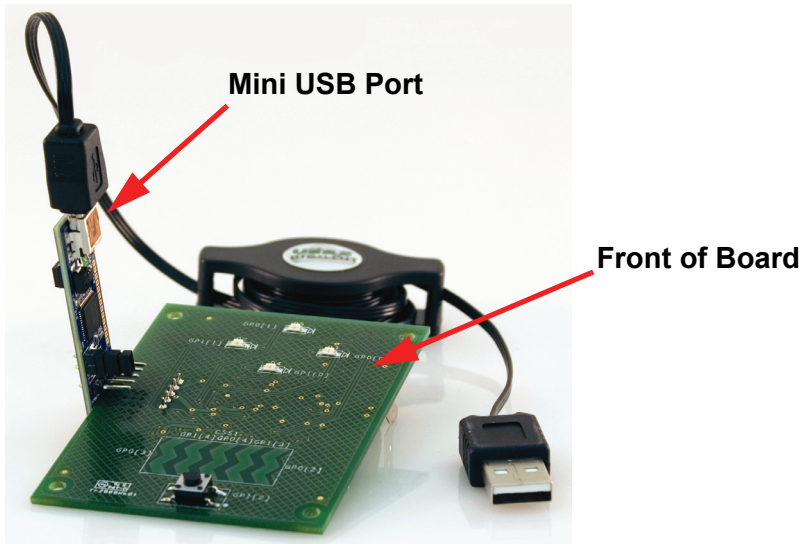

- 5.2. Launch PSoc Express.

- 5.3. From the Express Design Catalog, open the **CY3218 CAPEXP2 CapSense Express Kit** folder.

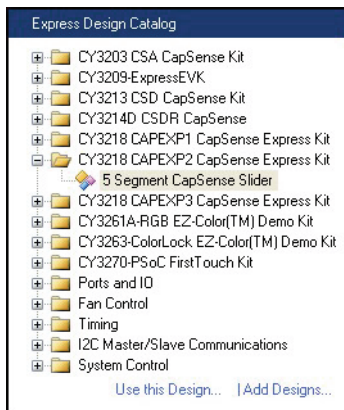

- 5.4. Double-click **5 Segment CapSense Slider** to open the design.
- 5.5. Name the design **FiveSegmentSlider** and save the design in the location of your choice.
- 5.6. Click **Monitor** to open the Monitor view.



- 5.7. The Monitor Status indicator shows Connected .
- 5.8. Right-click **Input1** and select **Show Tuner**.

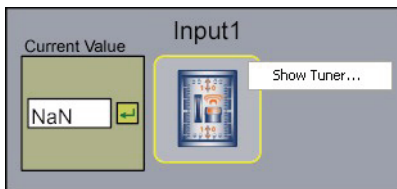

The Monitor Status indicator changes to Running , and the CapSense Express window opens.

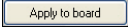
- 5.9. If your board is programmed with another design, click **Apply to board**  in the lower-right area of the CapSense Express window. When the Configure through USB2IIC Bridge status dialog appears, click **OK**. If your board is already programmed with the correct design, the Apply to board button is grayed out.

5.10. Test the board by moving your finger across the slider. The LEDs above the slider turn on each time the corresponding slider segment is touched. Press the mechanical button at the bottom of the board to turn on all four LEDs.

Notice how the Pin Status and Latched Value indicators change from OFF to ON when a slider segment is touched.

Pin Assignment (16-QFN)	GP0[4]	GP0[3]	GP0[2]	GP1[4]	GP1[3]	GP0[1]	GP0[0]	GP1[0]	GP1[1]	GP1[2]
	Slidr0	Slidr1	Slidr2	Slidr3	Slidr4	G0	G1	G2	G3	G4
Pin Type	Capsent	Capsent	Capsent	Capsent	Capsent	GPOutp	GPOutp	GPOutp	GPOutp	GPInput
Inversion	No	No	No	No	No	Yes	Yes	Yes	Yes	No
Interrupt	OFF	OFF	OFF	OFF	OFF	OFF	OFF	OFF	OFF	OFF
Latch Direction	Rising	Rising	Rising	Rising	Rising	Rising	Rising	Rising	Rising	Rising
Drive Mode	Resistiv	Resistiv	Resistiv	Resistiv	Resistiv	Strong C	Strong C	Strong C	Strong C	Open Dre
Finger Threshold	100	100	100	100	100	100	100	100	100	100
IDAC Settings	14	14	14	14	14	14	14	14	14	14
GPIO Output	Output L	Output L	Output L	Output L	Output L	Output L	Output L	Output L	Output L	Logic 1
Pin Status	OFF	ON	ON	OFF	OFF	OFF	ON	ON	OFF	OFF
Latched Value	OFF	ON	ON	OFF	OFF	OFF	ON	ON	OFF	OFF

5.11. Press the mechanical button at the bottom of the board to turn on all four LEDs.

## Tune the Slider

5.12. From the **Select Pin** menu, select **Slider**.

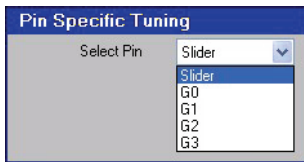

5.13. Check **Show Differences**.

5.14. Slide your finger across the slider. Notice the difference bars above the green position bar. Also notice how the LEDs illuminate in a clockwise direction as you move your finger from the left to the right across the slider.

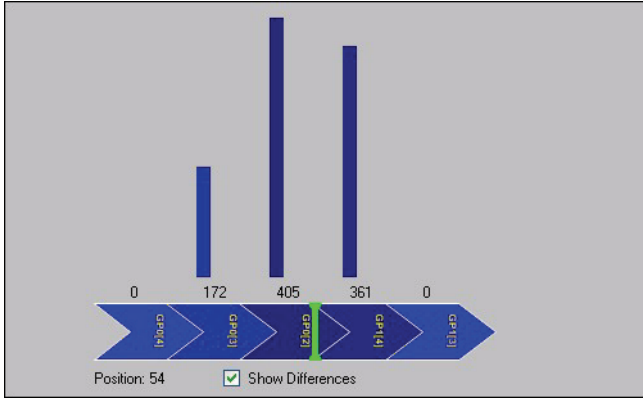

5.15. Cover the slider with a piece of paper and then touch the slider (with the paper between our finger and the slider). Notice how the Difference Count Value changes. Add additional pieces of paper to increase the thickness over the button. With enough sheets of paper added, the Difference variable does not rise above the Finger Threshold, and the button does not register a Hit. With 16 sheets of paper over the slider, the difference bars are very low and the LEDs do not light up.

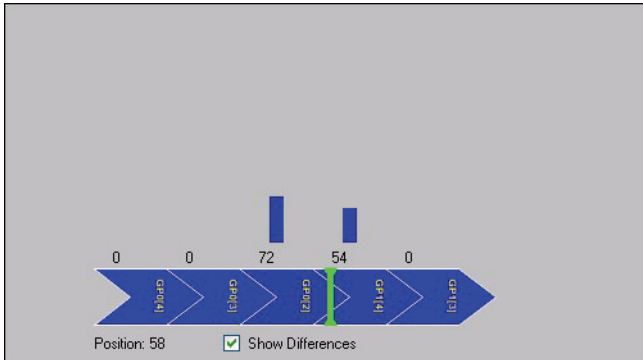

5.16. Change the IDAC setting for each segment from 14 to 5, and click **Apply to board.**'

Pin Assignment (16-QFN)	GP0[4]	GP0[3]	GP0[2]	GP1[4]	GP1[3]	GP0[1]	GP0[0]	GP1[0]	GP1[1]	GP1[2]
	Slidr0	Slidr1	Slidr2	Slidr3	Slidr4	G0	G1	G2	G3	G4
Pin Type	Capsens	Capsens	Capsens	Capsens	Capsens	GP0utp	GP0utp	GP0utp	GP0utp	GPInput
Inversion	No	No	No	No	No	Yes	Yes	Yes	Yes	No
Interrupt	OFF	OFF	OFF	OFF	OFF	OFF	OFF	OFF	OFF	OFF
Latch Direction	Rising	Rising	Rising	Rising	Rising	Rising	Rising	Rising	Rising	Rising
Drive Mode	Resistivi	Resistivi	Resistivi	Resistivi	Resistivi	Strong C	Strong C	Strong C	Strong C	Open Dre
Finger Threshold	100	100	100	100	100	100	100	100	100	100
IDAC Settings	5	5	5	5	5	14	14	14	14	14
GPIO Output	Output	Output	Output	Output	Output	Output	Output	Output	Output	Logic 1
Pin Status	OFF	OFF	OFF	OFF	OFF	OFF	OFF	OFF	OFF	OFF
Latched Value	OFF	OFF	OFF	OFF	OFF	OFF	OFF	OFF	OFF	OFF

5.17. Cover the slider with the paper again, and touch the slider. The difference bars are now higher. If the LEDs do not light, keep adjusting the IDAC settings lower until the LEDs light reliably.

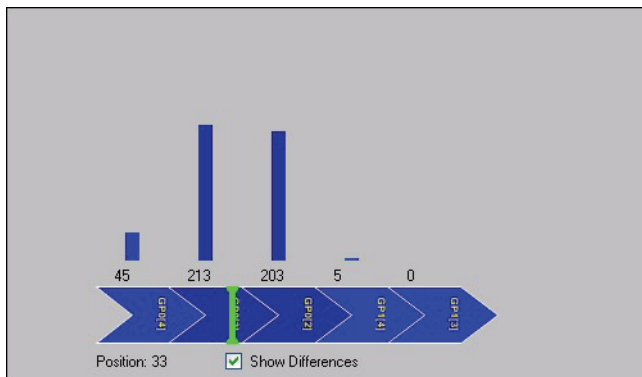

5.18. Experiment with other materials such as plastic and wood.

## What's Next

Now that you know how easy it is to tune a CapSense slider with PSoC Express, learn how to create the project from scratch in Section 6.



## 6. Create a CY3218-CAPEXP2 CapSense Express Project

### Start the Project

- 6.1. Connect your computer to the CapSense test board I<sup>2</sup>C Connector (J5)  using the CY3240-I2USB Bridge Board and a USB cable. When connected correctly, the USB connector on the CY3240-I2USB Bridge Board is visible when viewing the front of the CY3218-CAPEXP2 board.

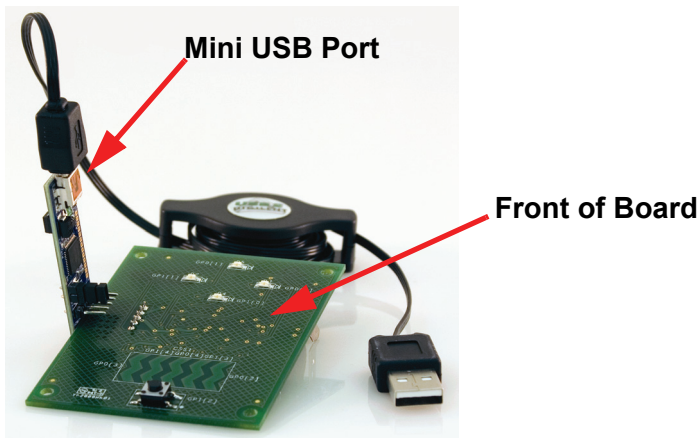

- 6.2. Launch PSoc Express.
- 6.3. Click **New Project**, name the project **FiveSegmentSlider**, and save the design in the location of your choice.
- 6.4. Select **View > Driver Catalog**.
- 6.5. At the bottom of the Driver Catalog, select the **Inputs Tab**.
- 6.6. Open the CapSense Express directory, right-click the **5 Segment Slider 5 GPIO** driver, and select **Add to Design**. The Add Input Driver window opens.

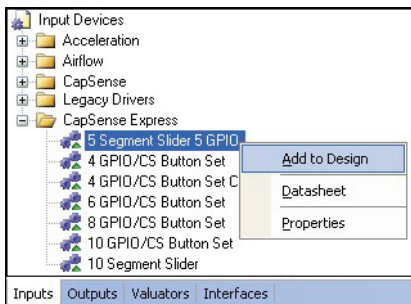

6.7. Name the driver **Slider** and click **OK**. The CapSense Express 5 Segment / Slider 5 GPIO : Slider window opens.

In PSoC Express, each CapSense slider, LED, and mechanical button requires a separate driver. The 5 Segment Slider 5 GPIO driver is a special driver that allows you to configure the slider, LED, and mechanical button in one interface. Each driver is listed in the Configure Local Parameters pane.

**CapSense Express 5 Segment / Slider 5 GPIO : Slider \* WARNING! You must apply to board to observe changes!**

### Configure Local Parameters

	Slidr0	Slidr1	Slidr2	Slidr3	Slidr4	C0	C1	C2	C3	C4
Pin Assignment (16-SDIC)										
Pin Type	Capsens	Capsens	Capsens	Capsens	Capsens	Capsens	Capsens	Capsens	Capsens	Capsens
Inversion	No	No	No	No	No	No	No	No	No	No
Interrupt	OFF	OFF	OFF	OFF	OFF	OFF	OFF	OFF	OFF	OFF
Latch Direction	Rising	Rising	Rising	Rising	Rising	Rising	Rising	Rising	Rising	Rising
Drive Mode	Resistiv	Resistiv	Resistiv	Resistiv	Resistiv	Resistiv	Resistiv	Resistiv	Resistiv	Resistiv
Finger Threshold	100	100	100	100	100	100	100	100	100	100
IDAC Settings	14	14	14	14	14	14	14	14	14	14
GPIO Output	Output L	Output L	Output L	Output L	Output L	Output L	Output L	Output L	Output L	Output L

### Pin Specific Tuning

Select Pin:

### Configure Global Parameters

- CapSense Specific**
  - Baseline Update Threshc: 100
  - Clock: IMO/4
  - Debounce: 3
  - External Capacitor: Disable
  - Hysteresis: 10
  - Low baseline reset: 20
  - Negative noise threshold: 20
  - Noise Threshold: 40
  - Resolution: 100
  - Sensor Auto Reset: Disable
  - Settling time: 160
- Global Parameters**
  - I2C Address: 0

**CapSense Specific**

Ok Apply to board Cancel

Export Report

## Configure the Drivers

6.8. By default, all driver types in the Configure Local Parameters pane are set to CapSense Slider Sensor. To setup the LEDs, set the Pin Type for drivers C0 through C3 to **GPOutput** and the Drive Mode for each of those drivers to **Strong Drive**.

To setup the mechanical button, set the Pin Type for driver G4 to **GPInput**. Set the Drive Mode to **Open Drain Low**.

Pin Assignment (16-S01C)	U	U	U	U	U	U	U	U	U	U
	Sldr0	Sldr1	Sldr2	Sldr3	Sldr4	G0	G1	G2	G3	G4
Pin Type	Capsens	Capsens	Capsens	Capsens	Capsens	GPOutp	GPOutp	GPOutp	GPOutp	GPInput
Inversion	No	No	No	No	No	No	No	No	No	No
Interrupt	OFF	OFF	OFF	OFF	OFF	OFF	OFF	OFF	OFF	OFF
Latch Direction	Rising	Rising	Rising	Rising	Rising	Rising	Rising	Rising	Rising	Rising
Drive Mode	Resistivi	Resistivi	Resistivi	Resistivi	Resistivi	Strong C	Strong C	Strong C	Strong C	Open Dra
Finger Threshold	100	100	100	100	100	100	100	100	100	100
IDAC Settings	14	14	14	14	14	14	14	14	14	14
GPIO Output	Output L	Output L	Output L	Output L	Output L	Output L	Output L	Output L	Output L	Logic 1

## Configure Slider and LED Behavior

6.9. In the Pin Specific Tuning pane, choose **G0** from the **Select Pin** menu.



6.10. To assign an LED to a CapSense slider segment, simply click on the yellow box of the CapSense slider segment you want to assign to LED G0. For LED driver G0, select the CapSense slider segment Sldr0. A small line will then connect C0 to the purple OR box. To have the LED turn on when the slider segment is touched, click the little box to the right of the purple OR box. This will change the square to an invert symbol.

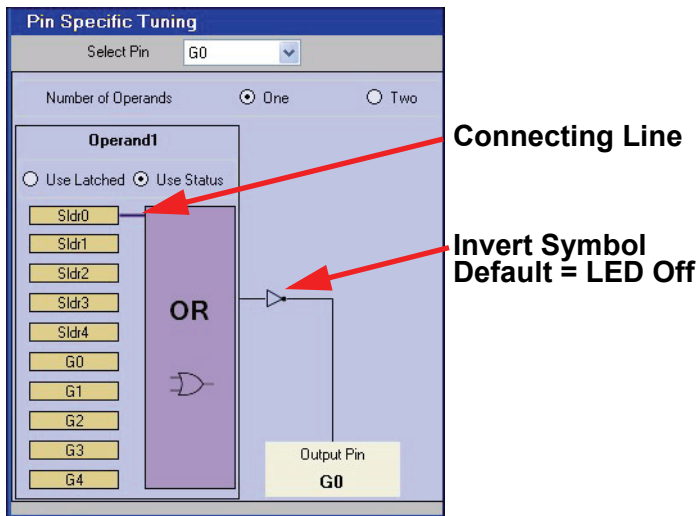

6.11. Since there are four LEDs and five slider segments, have the LED G0 turn on when the first and last slider segments are touched. To do this, simply click on the yellow **Slidr4** box.

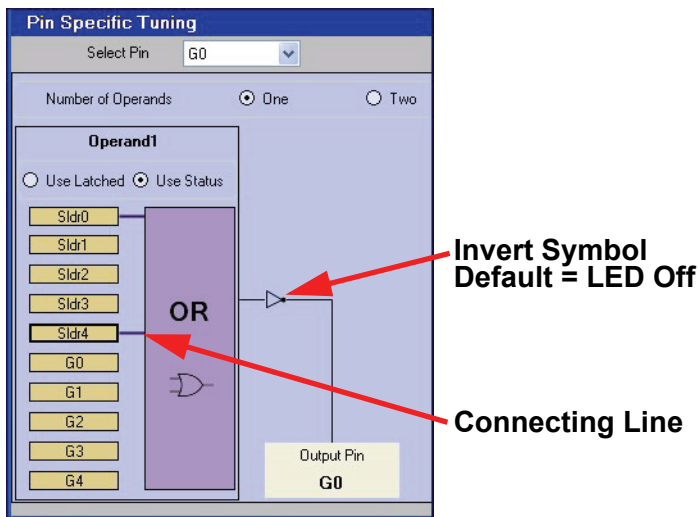

6.12. To have the LED G0 turn on when the mechanical button is pressed, click the yellow G4 box.

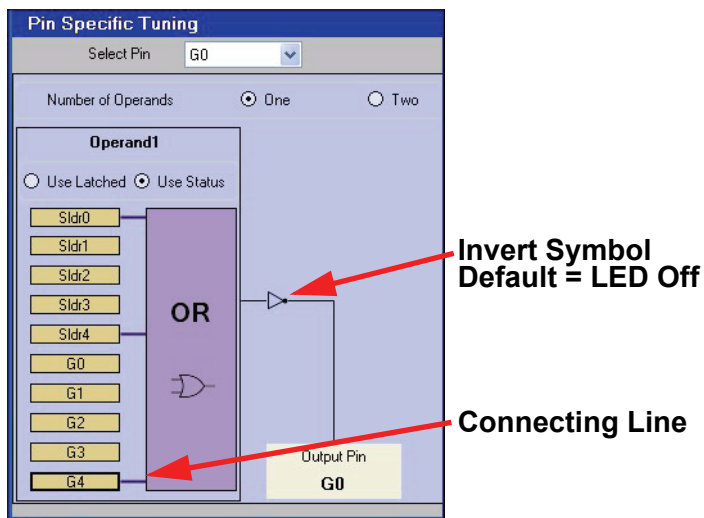

6.13. To assign the rest of the slider segments to the other LEDs, simply select each LED from the Select Pin menu, and click on the appropriate slider segment, and the G4 mechanical button. Remember to click the square box so the invert symbol is showing. Control the LEDs with the slider segments mechanical button according to the following table:

LED	Control
G0	Sldr0, Sldr4, & G4
G1	Sldr1 & G4
G2	Sldr2 & G4
G3	Sldr3 & G4

## Assign Drivers to Pins

6.14. In the upper-left of the window, click the Pin Assignment (16-SOIC) button. The User Pin Assignment window opens.



6.15. Select the **16 pin QFN** part for the Pin Package Type.

**Pin Package Type**

8 pin SOIC     16 pin SOIC     16 pin QFN

6.16. Assign each CapSense slider segment, LED, and mechanical button to the pin annotated on the board. For example, the leftmost slider segment, Sldr1, is labeled GP0[3].

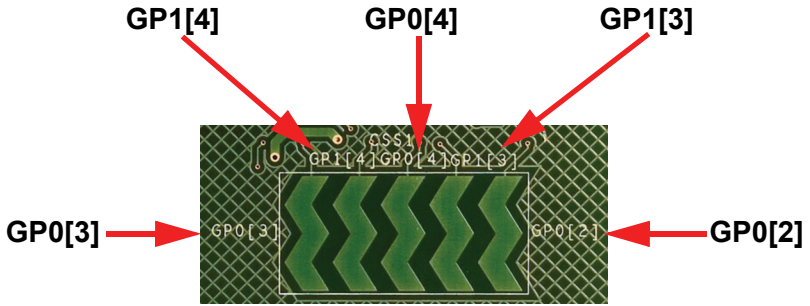

Drag each driver from the Unassigned list to the appropriate pin (listed on page 16 for convenience).

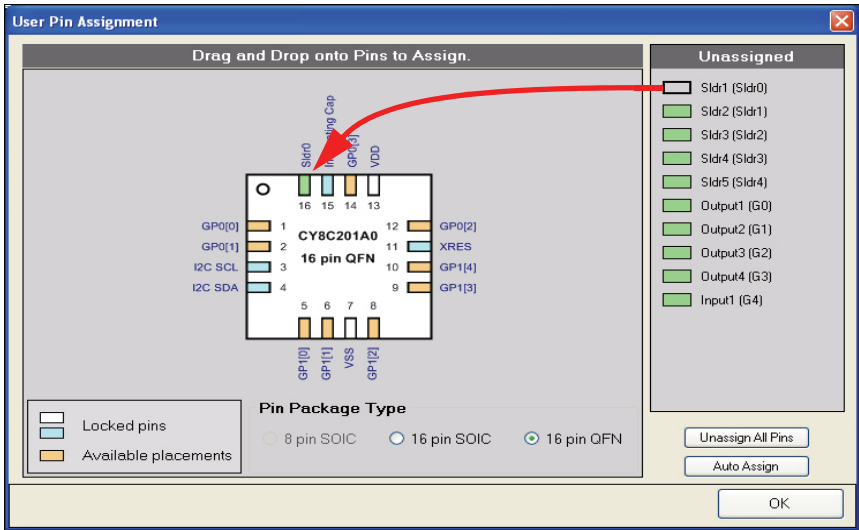

Driver	Pin
Sldr1 (Sldr0)	GP0[4]
Sldr2 (Sldr1)	GP0[3]
Sldr3 (Sldr2)	GP0[2]
Sldr4 (Sldr3)	GP1[4]
Sldr5 (Sldr4)	GP1[3]
Output1 (G0)	GP0[1]
Output2 (G1)	GP0[0]
Output3 (G2)	GP1[0]
Output4 (G3)	GP1[1]
Input1 (G4)	GP1[2]

- 6.17. Click **OK** to close the User Pin Assignment window.
- 6.18. Click **Apply to board**. Wait for the Configure through USB2IIC Bridge status window appears and click **OK**.
- 6.19. Click **OK** to close the CapSense Express CapSense Express 5 Segment / Slider 5 GPIO : Slider window.

## Monitor the Board

- 6.20. In the Design pane, select **Monitor**. The Monitor Status indicator shows Connected .



- 6.21. Right-click **Slider** and select **Show Tuner**.

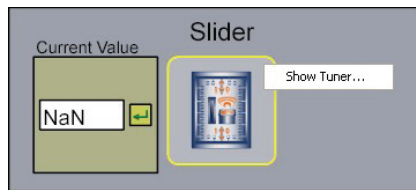

The Monitor Status indicator changes to Running , and the CapSense Express 5 Segment / Slider 5 GPIO : Slider window opens.



6.22. In the Pin Specific Tuning pane, check **Show Differences**.

6.23. Slowly move your finger from left to right across the slider. The LEDs light clockwise starting with the topmost LED on the board.

6.24. Press the mechanical button. All LEDs light at the same time.

## What's Next

Congratulations! You have successfully recreated the factory installed program used in Section 5. To experiment with slider and LED behavior, select any LED (G3 through G8) from the Select Pin menu in the Pin Specific Tuning pane and set different slider segments to light different LEDs. You can also reverse the inversion so that an LED is on until a button is pressed. To tune the CapSense slider, follow the steps listed in Section 5.

# 7. Additional CapSense Resources

## PSoC Data Sheets, Application Notes and Technical Articles

Cypress provides a wealth of information about CapSense Express, and more is frequently added. Many sample documents, schematics, layouts, guidelines, and other CapSense Express documents are available on the CD and at [www.cypress.com](http://www.cypress.com) (except where indicated). To find documentation online:

- a. Go to [www.cypress.com](http://www.cypress.com).
- b. Click on the **Documentation** link.
- c. Select the type of documentation you are looking for from the **Resource Types** list.
- d. Type the part number or document number into the **Search in Design Resources** field.
- e. Click the **Search** button .

### **CapSense Express DataSheets** (available on [www.cypress.com](http://www.cypress.com))

- [CY8C20110](#) Up to 10 IOs for touch sensing buttons, LEDs, and GPIOs
- [CY8C201A0](#) Up to 10 IOs for touch sensing buttons/sliders, LEDs, and GPIOs
- [CY8C20180](#) Up to 8 IOs for touch sensing buttons, LEDs, and GPIOs
- [CY8C20160](#) Up to 6 IOs for touch sensing buttons, LEDs, and GPIOs
- [CY8C20140](#) Up to 4 IOs for touch sensing buttons, LEDs, and GPIOs (16-Pin QFN/SOIC)
- [CY8C20142](#) Up to 4 IOs for touch sensing buttons, LEDs, and GPIOs (8-Pin SOIC)

### **CapSense Application Notes**

- [AN44207](#), *CapSense Express - API's for Register Configuration* (available on [www.cypress.com](http://www.cypress.com))
- [AN44208](#), *CapSense Express - I2C Communication Timing Information* (available on [www.cypress.com](http://www.cypress.com))
- [AN42137](#), *CapSense Express Software Tool*
- [AN44203](#), *Configuring CapSense Express in Production*
- [AN44209](#), *CapSense Express Power and Sleep Considerations*
- [AN2292](#), *Layout Guidelines for PSoC™ CapSense*
- [AN2318](#), *EMC Design Considerations for PSoC CapSense Applications*
- [AN2394](#), *CapSense Best Practices*
- [AN2397](#), *CapSense Data Viewing Tool*
- [AN2403](#), *Signal-to-Noise Ratio Requirement for CapSense Applications*
- [AN14459](#), *CapSense Device and Method Selection Guide*

## **CapSense Technical Articles**

- [Designer's Guide to Rapid Prototyping of Capacitive Sensors on any Surface](#)
- [Controls & Sensors Touch Sensors Spread Out](#)
- [White Paper Cypress's CapSense Successive Approximation Algorithm](#)
- [The Art of Capacitive Touch Sensing](#)

## **Design Support**

### **PSoC Development Software Online**

All PSoC development software tools are available for download online. For PSoC Express, visit [www.cypress.com/psocexpress](http://www.cypress.com/psocexpress). For PSoC Designer visit [www.cypress.com/psocdesigner](http://www.cypress.com/psocdesigner). For PSoC Programmer visit [www.cypress.com/psocprogrammer](http://www.cypress.com/psocprogrammer).

### **PSoC Device Selector Guide**

In the PSoC Application Notes section, search for AN2209—The Device Selection Guide for PSoC. It is a useful tool for determining exactly which PSoC device you should use for a specific design project.

### **PSoC Development Tools Selector Guide**

In the PSoC Application Notes section, search for AN2402—The PSoC Development Tools Selector Guide. This is a complete catalog and description of all the development tools that support PSoC devices and when to use them in your design cycle—from concept to production.

### **PSoC On-Demand Training**

Visit [www.cypress.com/psoctraining](http://www.cypress.com/psoctraining) to engage in on-demand self-paced PSoC product and development software training. Learn to design PSoC like the pros, at the introductory, intermediate, and advanced knowledge levels!

### **PSoC On-Site Training**

Email [training@cypress.com](mailto:training@cypress.com) to enquire about PSoC in-person training seminars at a location near you. Learn design basics, tips, and tricks from the pros to become a PSoC design expert!

### **Online Technical Support**

For knowledge base articles, customer forums, and online application support, visit [www.cypress.com/support](http://www.cypress.com/support).

# Additional CapSense Kits

## Evaluation Kits

## Development Kit

**CY3218  
CAPEXP1/CAPEXP3  
For Buttons  
(Up to 10 or 4 IOs)**

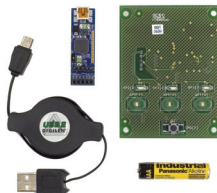

**CY3218  
CAPEXP2  
For Sliders  
(Up to 10 IOs)**



**CapSense Express:** Quickest and Easiest to Use Touch Sensing

**CY3203A  
CapSense CSA**



**CapSense:** Programmable Touch Sensing

**CY3280-BK1  
Universal CapSense**



**CY3213A  
CapSense CSD**



**CapSense Plus:** CapSense with Non-Touch Sensing Functionality (Motor Control, Power Management, Gyro Sensing, etc.)

**CY3214  
PSoCEvalUSB**



For more information on these kits, please go to [www.cypress.com/CapSense](http://www.cypress.com/CapSense).

CapSense™, PSoC Designer™, Programmable System-on-Chip™, and PSoC Express™ are trademarks and PSoC® is a registered trademark of Cypress Semiconductor Corp. All other trademarks or registered trademarks referenced herein are property of the respective corporations.



198 Champion Ct., San Jose, CA 95134  
408.943.2600, [www.cypress.com](http://www.cypress.com)



For you have questions, call the  
**Applications Hot Line 425.787.4814**  
[www.cypress.com/support](http://www.cypress.com/support)

©2008 Cypress Semiconductor Corporation  
Doc. # 001-44863 Rev. \*A