

NEW

LED

Infrared LED

L9337

High power LED for optical switches



L9337 is an infrared LED developed for optical switches. Because a high-power LED chip is mounted, L9337 provides higher radiant output power than previous devices, yet is available at a low cost due to the improved manufacturing process. L9337 also achieves a directivity that matches applications using a light-transmitting lens.

Features

- High radiant output power: 1.5 times higher than previous device (L2656)
- High reliability
- Low price

Applications

- Optical switches

■ Absolute maximum ratings (Ta=25 °C, unless otherwise noted)

Parameter	Symbol	Condition	Value	Unit
Reverse voltage	VR		5	V
Forward current	IF		80	mA
Forward current reduction rate	-	Ta > 25 °C	1.1	mA/°C
Pulse forward current	IFP	Pulse width=10 μs Duty ratio=1 %	1.0	A
Pulse forward current reduction rate	-	Ta > 25 °C	13	mA/°C
Power dissipation	P		150	mW
Operating temperature	Topr		-30 to +85	°C
Storage temperature	Tstg		-40 to +100 *1	°C

*1: Guaranteed to resist temperature cycle test of up to 5 cycles.

■ Electrical and optical characteristics (Ta=25 °C)

Parameter	Symbol	Condition	Min.	Typ.	Max.	Unit
Peak emission wavelength	λp	IF=50 mA	840	870	900	nm
Spectral half width	Δλ	IF=50 mA	-	45	-	nm
Forward voltage	VF	IF=50 mA	-	1.47	1.55	V
Pulse forward voltage	VFP	IF=1 A	-	3.5	4.3	V
Reverse current	IR	VR=5 V	-	-	5	μA
Radiant flux	φe	IF=50 mA	18	23	-	mW
Cut-off frequency *2	fc	IF=50 mA ± 4 mAp-p	25	40	-	MHz

*2: Frequency at which the optical output drops by -3 dB from that at 100 kHz.

Emission spectrum

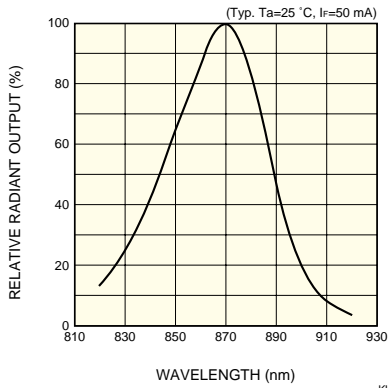

KLEDB0249EA

Radiant flux vs. forward current

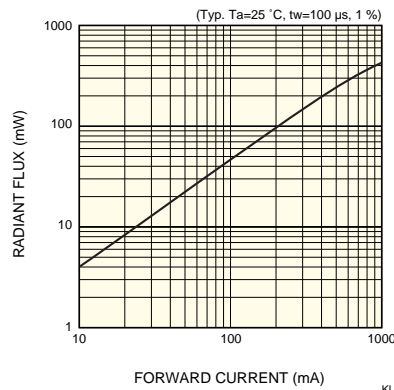

KLEDB0250EA

Forward current vs. forward voltage

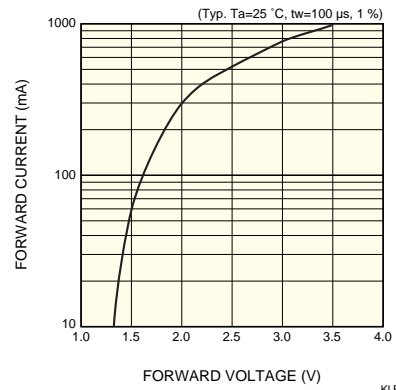

KLEDB0251EA

Directivity

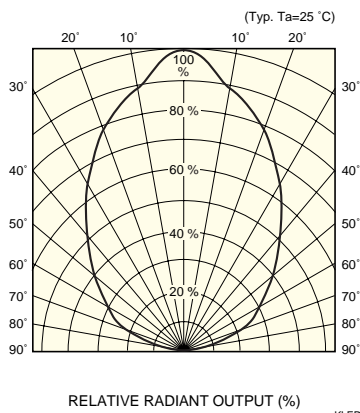

KLEDB0252EA

Radiant output vs. ambient temperature

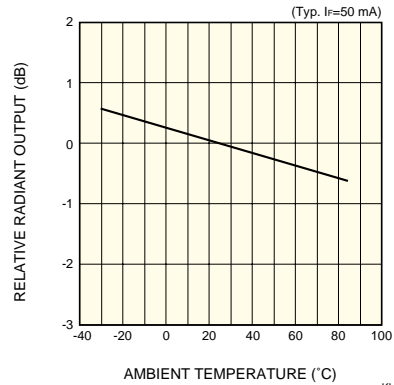

KLEDB0253EA

Allowable forward current vs. ambient temperature

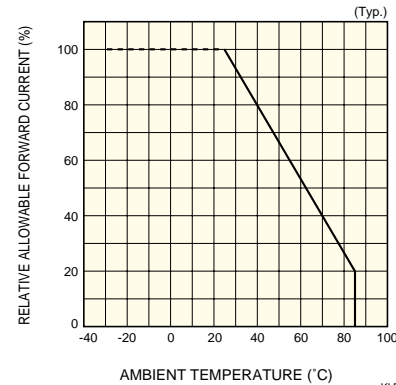

KLEDB0254EA

Allowable forward current vs. duty ratio

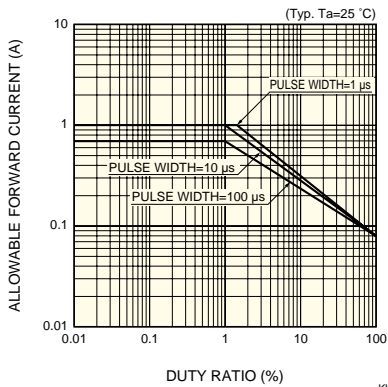

KLEDB0038EA

Dimensional outline (unit: mm)

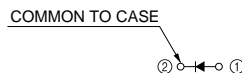
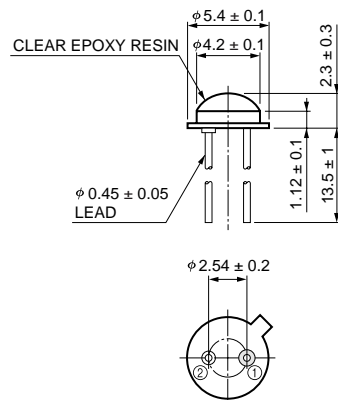

KLEDA0081EA

HAMAMATSU

Information furnished by HAMAMATSU is believed to be reliable. However, no responsibility is assumed for possible inaccuracies or omissions. Specifications are subject to change without notice. No patent rights are granted to any of the circuits described herein. ©2003 Hamamatsu Photonics K.K.

HAMAMATSU PHOTONICS K.K., Solid State Division

1126-1 Ichino-cho, Hamamatsu City, 435-8558 Japan, Telephone: (81) 053-434-3311, Fax: (81) 053-434-5184, <http://www.hamamatsu.com>

U.S.A.: Hamamatsu Corporation, 360 Foothill Road, P.O.Box 6910, Bridgewater, N.J. 08807-0910, U.S.A., Telephone: (1) 908-231-0960, Fax: (1) 908-231-1218

Germany: Hamamatsu Photonics Deutschland GmbH, Arzbergerstr. 10, D-82211 Herrsching am Ammersee, Germany, Telephone: (49) 08152-3750, Fax: (49) 08152-2658

France: Hamamatsu Photonics France S.A.R.L.: 8, Rue du Saule Trapu, Parc du Moulin de Massy, 91882 Massy Cedex, France, Telephone: 33-(1) 69 53 71 00, Fax: 33-(1) 69 53 71 10

United Kingdom: Hamamatsu Photonics UK Limited, 2 Howard Court, 10 Tewin Road, Welwyn Garden City, Hertfordshire AL7 1BW, United Kingdom, Telephone: (44) 1707-294888, Fax: (44) 1707-325777

North Europe: Hamamatsu Photonics Norden AB, Smidesvägen 12, SE-171 41 Solna, Sweden, Telephone: (46) 8-509-031-00, Fax: (46) 8-509-031-01

Italy: Hamamatsu Photonics Italia S.R.L.: Strada della Moia, 1/E, 20020 Arese, (Milano), Italy, Telephone: (39) 02-935-81-733, Fax: (39) 02-935-81-741

Cat. No. KLED1043E01
Nov. 2003 DN