

AC 9P



SIZE :

92x92x25mm (3.62"x3.62"x0.98")

CONSTRUCTION :

- Die-cast aluminum housing
- Glass fiber reinforced plastic:
Impeller are UL 94V-0 rating
- Impedance protected
- Leader wire or Terminal is available

OPERATING TEMPERATURE :

Ball bearing - 30°C to +75°C

Sleeve bearing - 10°C to +70°C

WEIGHT :

280 grams



Specifications

Specifications are subject to change without notice

MODEL NO.	BEARING	RATED VOLTAGE	FREQUENCY	MAX. RATED CURRENT	MAX. INPUT POWER	SPEED R.P.M.	MAX. AIR FLOW		MAX. AIR PRESSURE		NOISE dB-A
		VAC	Hz	mA	W		m ³ /min	CFM	mmH ₂ O	IN H ₂ O	
9P-115LB	Ball	115	50/60	140/120	14/13	1800/2300	0.63/0.76	22.35/26.56	2.15/2.84	0.08/0.11	28/35
9P-115LS	Sleeve										
9P-230LB	Ball	230	50/60	80/70	16/14	1800/2300	0.63/0.76	22.35/26.56	2.15/2.84	0.08/0.11	28/35
9P-230LS	Sleeve										
9P-115HB	Ball	115	50/60	160/140	16/14	2400/2900	0.79/0.96	28.56/34.17	2.96/4.21	0.12/0.17	35/41
9P-115HS	Sleeve										
9P-230HB	Ball	230	50/60	80/70	16/14	2400/2900	0.79/0.96	28.56/34.17	2.96/4.21	0.12/0.17	35/41
9P-230HS	Sleeve										

Dimensions (mm)

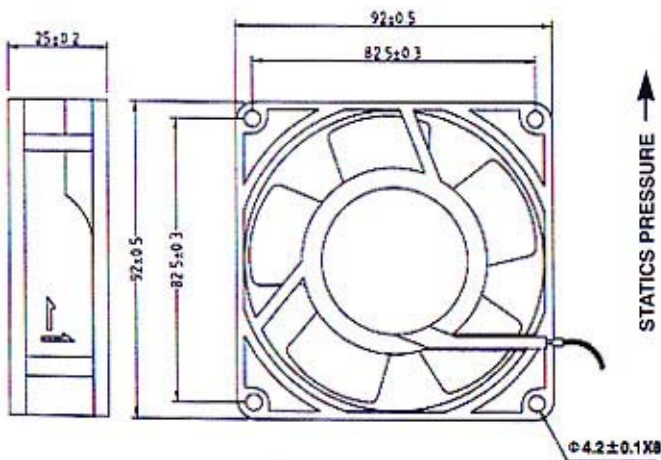

Performance Curve

