



SEMIPACK® 3

Rectifier Diode Modules

SKKD 260

Features

- Heat transfer through aluminium nitride ceramic isolated metal baseplate
- Precious metal pressure contacts
- UL recognized, file no. E 63 532

Typical Applications*

- Non-controllable rectifiers for AC/AC converters
- Line rectifiers for transistorized AC motor controllers
- Field supply for DC motors

1) The screws must be lubricated

V_{RSM} V	V_{RRM} V	$I_{FRMS} = 410$ A (maximum value for continuous operation) $I_{FAV} = 260$ A (sin. 180; $T_c = 85$ °C)	
900	800	SKKD 260/08	
1300	1200	SKKD 260/12	
1700	1600	SKKD 260/16	
2100	2000	SKKD 260/20H4	
2300	2200	SKKD 260/22H4	

Symbol	Conditions	Values	Units
I_{FAV}	sin. 180; $T_c = 85$ (100) °C	260 (185)	A
I_D	P3/180F; $T_a = 35$ °C; B2 / B6	280 / 320	A
	P16/200F; $T_a = 35$ °C; B2 / B6	490 / 655	A
I_{FSM}	$T_{vj} = 25$ °C; 10 ms	11000	A
	$T_{vj} = 130$ °C; 10 ms	10000	A
i^2t	$T_{vj} = 25$ °C; 8,3 ... 10 ms	605000	A ² s
	$T_{vj} = 130$ °C; 8,3 ... 10 ms	500000	A ² s
V_F	$T_{vj} = 25$ °C; $I_F = 750$ A	max. 1,25	V
$V_{(TO)}$	$T_{vj} = 130$ °C	max. 0,9	V
r_T	$T_{vj} = 130$ °C	max. 0,37	mΩ
I_{RD}	$T_{vj} = 130$ °C; $V_{RD} = V_{RRM}$	max. 10	mA
$R_{th(j-c)}$	cont.; per diode / per module	0,14 / 0,07	K/W
	sin. 180; per diode / per module	0,15 / 0,075	K/W
$R_{th(c-s)}$	per diode / per module	0,04 / 0,02	K/W
T_{vj}		- 40 ... + 130	°C
T_{stg}		- 40 ... + 130	°C
V_{isol}	a. c. 50 Hz; r.m.s.; 1 s / 1 min.	3600 / 3000	V~
V_{isol}	a. c. 50 Hz; r.m.s.; 1 s / 1 min. for SKK ...H4	4800 / 4000	V~
M_s	to heatsink	5 ± 15 %	Nm
M_t	to terminals	9 ± 15 % ¹⁾	Nm
a		5 * 9,81	m/s ²
m	approx.	600	g
Case		A 78b	

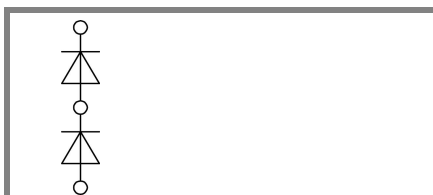

SKKD

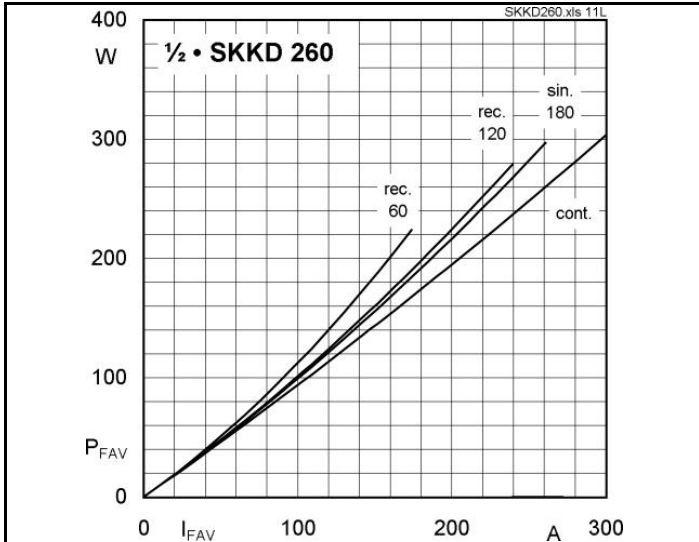

Fig. 11L Power dissipation per diode vs. forward current

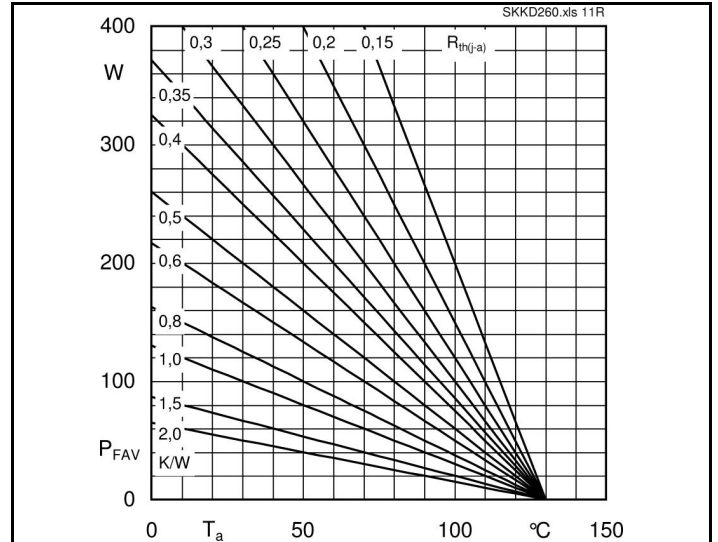

Fig. 11R Power dissipation per diode vs. ambient temperature

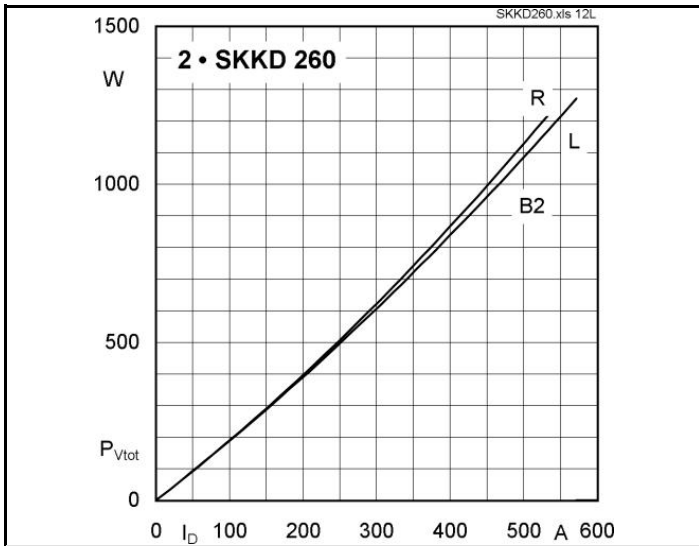

Fig. 12L Power dissipation of two modules vs. direct current

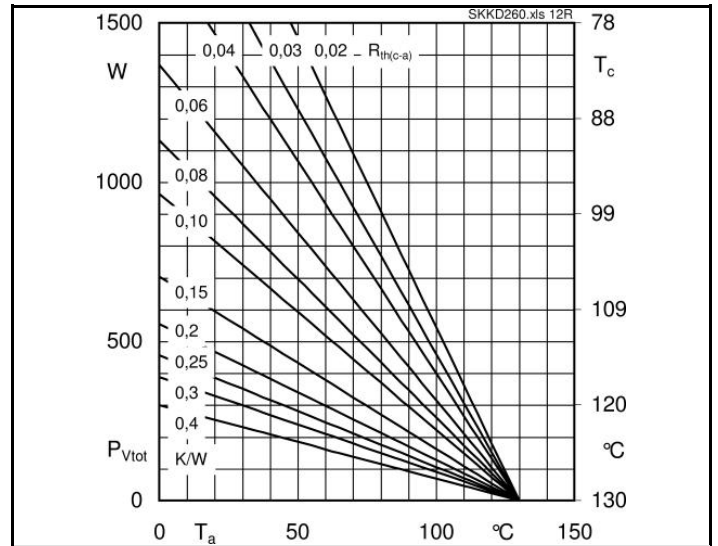

Fig. 12R Power dissipation of two modules vs. case temperature

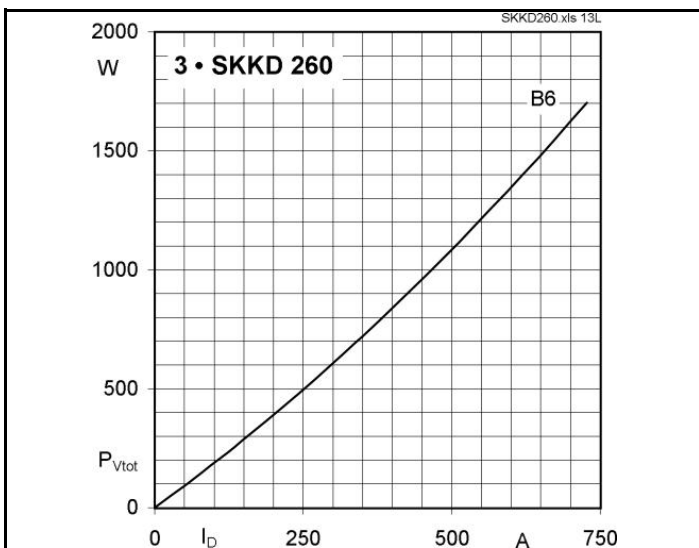

Fig. 13L Power dissipation of three modules vs. direct current

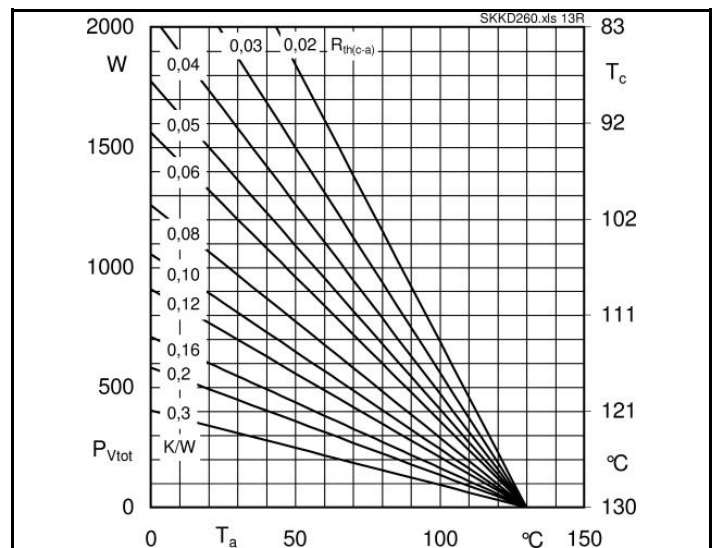

Fig. 13R Power dissipation of three modules vs. case temperature

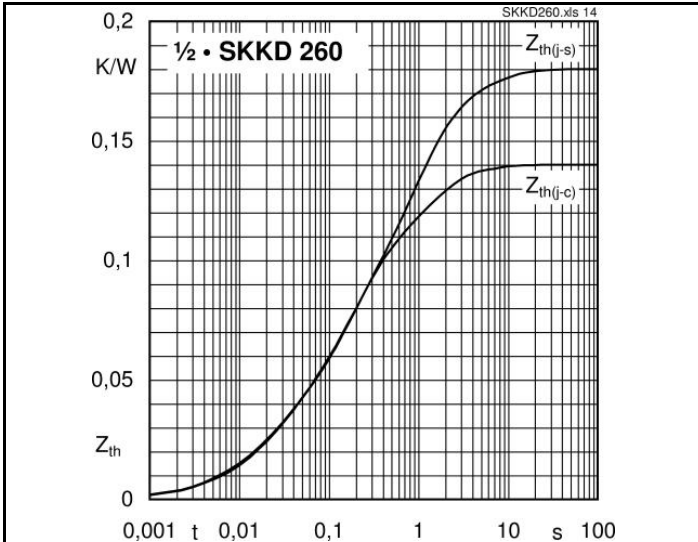

Fig. 14 Transient thermal impedance vs. time

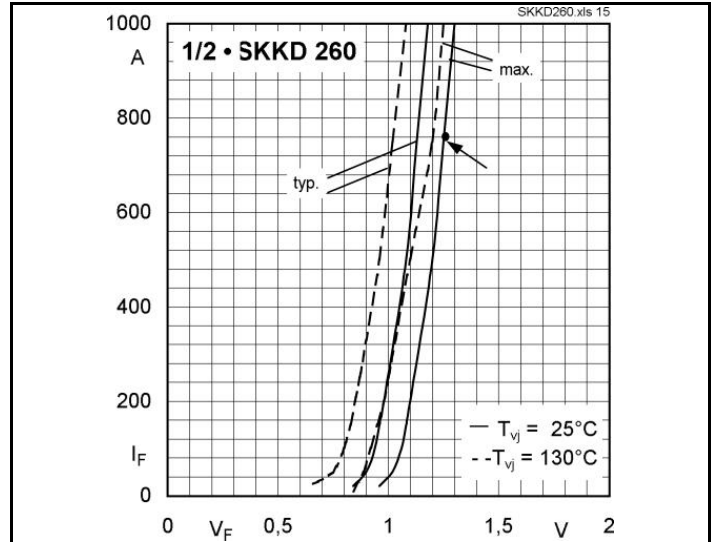

Fig. 15 Forward characteristics

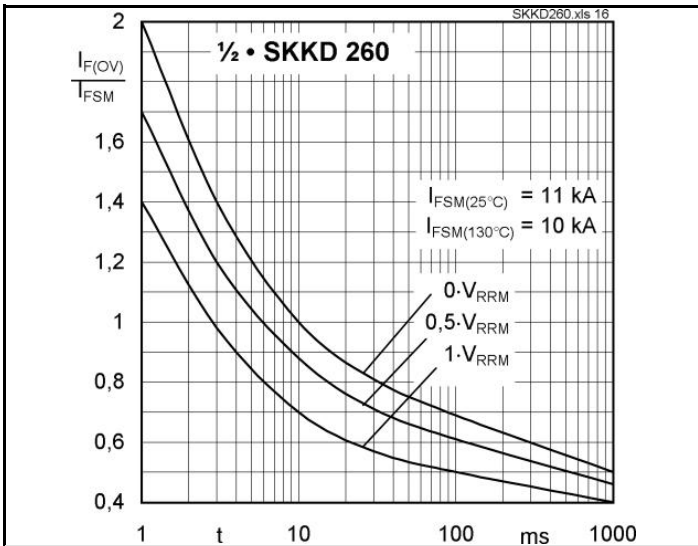
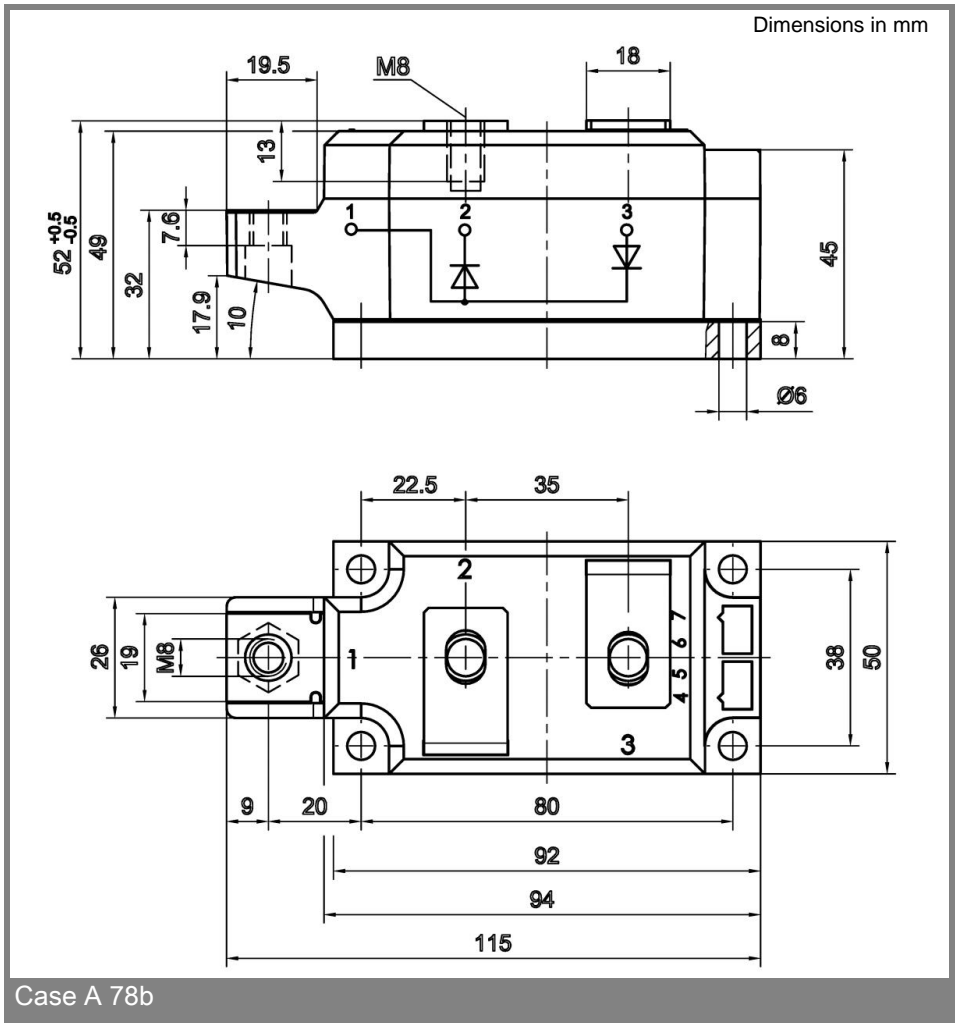

Fig. 16 Surge overload current vs. time



* The specifications of our components may not be considered as an assurance of component characteristics. Components have to be tested for the respective application. Adjustments may be necessary. The use of SEMIKRON products in life support appliances and systems is subject to prior specification and written approval by SEMIKRON. We therefore strongly recommend prior consultation of our personal.