

- NOTES:
1. MATERIAL= BACKSHELLS - ZINC DIECAST  
PULL - MOLDED PLASTIC
  2. LENGTH= SEE TABLE
  3. ELECTRICAL PERFORMANCE PER SERIAL ATTACH SCSI 1.1
  4. PLUG MATES TO RECEPTACLE 75586-0004, AND EMI HOUSING ASSY, 74548-0100
  5. ASSEMBLY IS TO BE ROHS COMPLIANT BY OCTOBER 1, 2005.

IPASS™ IS A TRADEMARK OF MOLEX

ENTER DESCRIPTION EC NO: USY2006-0151 DRW:KPHILLIPS 2006/02/06 CHK:DB.REED APPR:DDOYE 2006/02/24	QUALITY SYMBOLS ▽=0 ▽=0	GENERAL TOLERANCES (UNLESS SPECIFIED)		DIMENSION STYLE MM ONLY		SCALE 1:1	DESIGN UNITS METRIC	THIRD ANGLE PROJECTION		
		4 PLACES ± --- ± ---	3 PLACES ± --- ± ---	2 PLACES ± 0.13 ± ---	1 PLACE ± 0.25 ± ---	DRAWN BY KPHILLIPS	DATE 2005/28/07	TITLE I-PASS 26 CKT EXTERNAL CABLE ASSEMBLY, PLUG TO PLUG		
		ANGULAR ±1/2°		DRAFT WHERE APPLICABLE MUST REMAIN WITHIN DIMENSIONS		CHECKED BY BREED	DATE 2005/28/07	MATERIAL NO. SEE TABLE		
		APPROVED BY DDOYE		DATE 2005/28/07		DOCUMENT NO. SD-74547-100		SHEET NO. 1 OF 4		

KEYING IDENTIFIER  
SAS

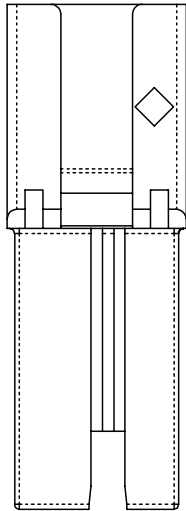

4,2  
TABLE  
ROUTING

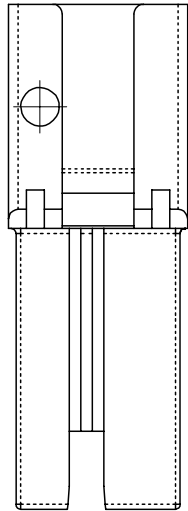

6,4  
SUBTRACTIVE  
ROUTING

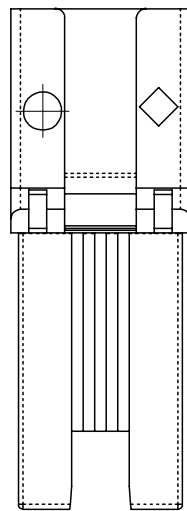

6,4,2  
UNIVERSAL  
KEY

MATERIAL NUMBER	DESCRIPTION	GAUGE	LENGTH	KEY	IDENTIFIER
745470101	X4 SAS CABLE ASSEMBLY	28 AWG	1M	2,4	TABLE ROUTING (OUT PORT), SAS
745470102	X4 SAS CABLE ASSEMBLY	28 AWG	2M	2,4	TABLE ROUTING (OUT PORT), SAS
745470103	X4 SAS CABLE ASSEMBLY	28 AWG	3M	2,4	TABLE ROUTING (OUT PORT), SAS
745470104	X4 SAS CABLE ASSEMBLY	28 AWG	4M	2,4	TABLE ROUTING (OUT PORT), SAS
745470105	X4 SAS CABLE ASSEMBLY	26 AWG	5M	2,4	TABLE ROUTING (OUT PORT), SAS
745470106	X4 SAS CABLE ASSEMBLY	24 AWG	6M	2,4	TABLE ROUTING (OUT PORT), SAS
745470107	X4 SAS CABLE ASSEMBLY	24 AWG	7M	△	TABLE ROUTING (OUT PORT), SAS
745470108	X4 SAS CABLE ASSEMBLY	24 AWG	8M	△	TABLE ROUTING (OUT PORT), SAS
745470109	X4 SAS CABLE ASSEMBLY	28 AWG	0.25M	2,4	TABLE ROUTING (OUT PORT), SAS
745470110	X4 SAS CABLE ASSEMBLY	28 AWG	0.5M	2,4	TABLE ROUTING (OUT PORT), SAS
745470201	X4 SAS CABLE ASSEMBLY	28 AWG	1M	4,6	SUBTRACTIVE ROUTING (IN PORT), SAS
745470202	X4 SAS CABLE ASSEMBLY	28 AWG	2M	4,6	SUBTRACTIVE ROUTING (IN PORT), SAS
745470203	X4 SAS CABLE ASSEMBLY	28 AWG	3M	4,6	SUBTRACTIVE ROUTING (IN PORT), SAS
745470204	X4 SAS CABLE ASSEMBLY	28 AWG	4M	4,6	SUBTRACTIVE ROUTING (IN PORT), SAS
745470205	X4 SAS CABLE ASSEMBLY	26 AWG	5M	4,6	SUBTRACTIVE ROUTING (IN PORT), SAS
745470206	X4 SAS CABLE ASSEMBLY	24 AWG	6M	4,6	SUBTRACTIVE ROUTING (IN PORT), SAS
745470207	X4 SAS CABLE ASSEMBLY	24 AWG	7M	△	SUBTRACTIVE ROUTING (IN PORT), SAS
745470208	X4 SAS CABLE ASSEMBLY	24 AWG	8M	△	SUBTRACTIVE ROUTING (IN PORT), SAS
745470209	X4 SAS CABLE ASSEMBLY	28 AWG	0.25M	4,6	SUBTRACTIVE ROUTING (IN PORT), SAS
745470210	X4 SAS CABLE ASSEMBLY	28 AWG	0.5M	4,6	SUBTRACTIVE ROUTING (IN PORT), SAS
745470301	X4 SAS CABLE ASSEMBLY	28 AWG	1M	2,4,6	UNIVERSAL KEY, SAS
745470302	X4 SAS CABLE ASSEMBLY	28 AWG	2M	2,4,6	UNIVERSAL KEY, SAS
745470303	X4 SAS CABLE ASSEMBLY	28 AWG	3M	2,4,6	UNIVERSAL KEY, SAS
745470304	X4 SAS CABLE ASSEMBLY	28 AWG	4M	2,4,6	UNIVERSAL KEY, SAS
745470305	X4 SAS CABLE ASSEMBLY	26 AWG	5M	2,4,6	UNIVERSAL KEY, SAS
745470306	X4 SAS CABLE ASSEMBLY	24 AWG	6M	2,4,6	UNIVERSAL KEY, SAS
745470307	X4 SAS CABLE ASSEMBLY	24 AWG	7M	△	UNIVERSAL KEY, SAS
745470308	X4 SAS CABLE ASSEMBLY	24 AWG	8M	△	UNIVERSAL KEY, SAS
745470309	X4 SAS CABLE ASSEMBLY	28 AWG	0.25M	2,4,6	UNIVERSAL KEY, SAS
745470310	X4 SAS CABLE ASSEMBLY	28 AWG	0.5M	2,4,6	UNIVERSAL KEY, SAS
MATERIAL NUMBER	DESCRIPTION	GAUGE	LENGTH	KEY	IDENTIFIER
745470119	X4 SAS CABLE ASSEMBLY	28 AWG	0.5M	2,4-4,6	SAS, TABLE ROUTING (OUT PORT), TO SUBTRACTIVE ROUTING (IN PORT)
745470120	X4 SAS CABLE ASSEMBLY	28 AWG	1M	2,4-4,6	SAS, TABLE ROUTING (OUT PORT), TO SUBTRACTIVE ROUTING (IN PORT)
745470121	X4 SAS CABLE ASSEMBLY	28 AWG	2M	2,4-4,6	SAS, TABLE ROUTING (OUT PORT), TO SUBTRACTIVE ROUTING (IN PORT)
745470122	X4 SAS CABLE ASSEMBLY	28 AWG	3M	2,4-4,6	SAS, TABLE ROUTING (OUT PORT), TO SUBTRACTIVE ROUTING (IN PORT)
745470123	X4 SAS CABLE ASSEMBLY	28 AWG	4M	2,4-4,6	SAS, TABLE ROUTING (OUT PORT), TO SUBTRACTIVE ROUTING (IN PORT)
745470124	X4 SAS CABLE ASSEMBLY	26 AWG	5M	2,4-4,6	SAS, TABLE ROUTING (OUT PORT), TO SUBTRACTIVE ROUTING (IN PORT)
745470125	X4 SAS CABLE ASSEMBLY	24 AWG	6M	2,4-4,6	SAS, TABLE ROUTING (OUT PORT), TO SUBTRACTIVE ROUTING (IN PORT)

△ - NOT COMPLIANT WITH INSERTION  
LOSS SPEC PER SAS 1.1

IPASS™ IS A TRADEMARK OF MOLEX

ENTER DESCRIPTION EC NO: USY2006-0151 DRWN:KPHILLIPS 2006/02/06 CHK'D:B. REED 2006/02/06 APPR:DDOYE 2006/02/14	DESCRIPTION REV	QUALITY SYMBOLS ▽=0 ▽=0	GENERAL TOLERANCES (UNLESS SPECIFIED) mm INCH 4 PLACES ± --- ± --- 3 PLACES ± --- ± --- 2 PLACES ± 0.13 ± --- 1 PLACE ± 0.25 ± --- ANGULAR ±1/2°	DIMENSION STYLE MM ONLY DRAWN BY DATE KPHILLIPS 2005/28/07 CHECKED BY DATE BREED 2005/28/07 APPROVED BY DATE DDOYE 2005/28/07	SCALE 1:1 DESIGN UNITS METRIC THIRD ANGLE PROJECTION	TITLE I-PASS 26 CKT EXTERNAL CABLE ASSEMBLY, PLUG TO PLUG MOLEX MOLEX INCORPORATED
		DRAFT WHERE APPLICABLE MUST REMAIN WITHIN DIMENSIONS	MATERIAL NO. SEE TABLE	DOCUMENT NO. SD-74547-100	SHEET NO. 2 OF 4	
		SIZE B	THIS DRAWING CONTAINS INFORMATION THAT IS PROPRIETARY TO MOLEX INCORPORATED AND SHOULD NOT BE USED WITHOUT WRITTEN PERMISSION			

10 9 8 7 6 5 4 3 2 1

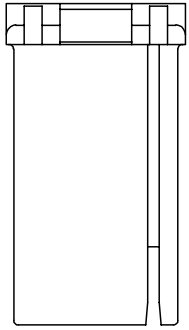

"X" CABLE

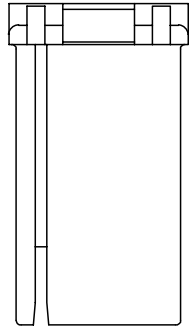

"M" CABLE

MATERIAL NUMBER	DESCRIPTION	GAUGE	LENGTH	KEY	IDENTIFIER
745470001	X4 SATA CABLE ASSEMBLY	28 AWG	1M	1	X CABLE, SATA
745470002	X4 SATA CABLE ASSEMBLY	28 AWG	2M	1	X CABLE, SATA
745470003	X4 SATA CABLE ASSEMBLY	28 AWG	3M	1	X CABLE, SATA
745470004	X4 SATA CABLE ASSEMBLY	28 AWG	4M	1	X CABLE, SATA
745470005	X4 SATA CABLE ASSEMBLY	26 AWG	5M	1	X CABLE, SATA
745470006	X4 SATA CABLE ASSEMBLY	24 AWG	6M	1	X CABLE, SATA
745470007	X4 SATA CABLE ASSEMBLY	24 AWG	7M $\triangle$	1	X CABLE, SATA
745470008	X4 SATA CABLE ASSEMBLY	24 AWG	8M $\triangle$	1	X CABLE, SATA
745470009	X4 SATA CABLE ASSEMBLY	28 AWG	0.25M	1	X CABLE, SATA
745470011	X4 SATA CABLE ASSEMBLY	28 AWG	0.5M	1	X CABLE, SATA
745470401	X4 SATA CABLE ASSEMBLY	28 AWG	1M	7	M CABLE, SATA
745470402	X4 SATA CABLE ASSEMBLY	28 AWG	2M	7	M CABLE, SATA
745470409	X4 SATA CABLE ASSEMBLY	28 AWG	0.25M	7	M CABLE, SATA
745470410	X4 SATA CABLE ASSEMBLY	28 AWG	0.5M	7	M CABLE, SATA

$\triangle$  - NOT COMPLIANT WITH INSERTION LOSS SPEC PER 1.1.

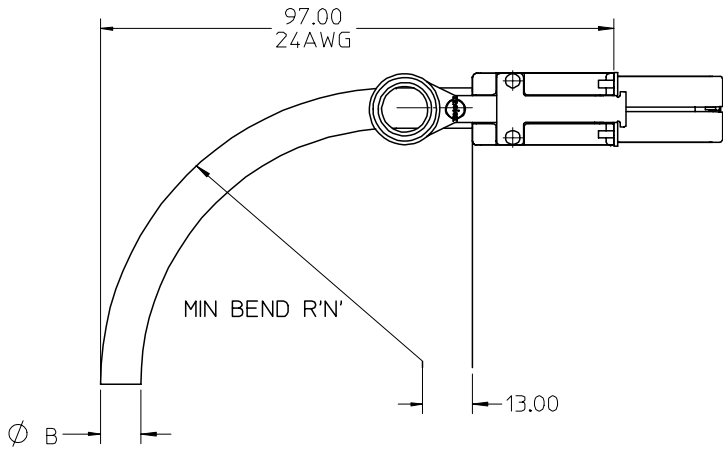

CABLE	A	B
24AWG	46.9	10.40
26AWG	41.7	9.30
28AWG	37.7	8.40

IPASS™ IS A TRADEMARK OF MOLEX

ENTER DESCRIPTION EC NO: USY2006-0151 DRW:KPHILLIPS 2006/02/06 CHK:D.B. REED 2006/02/06 APPR:DDOYE 2006/02/24	QUALITY SYMBOLS $\nabla=0$ $\nabla=0$	GENERAL TOLERANCES (UNLESS SPECIFIED)		DIMENSION STYLE MM ONLY		SCALE 1:1	DESIGN UNITS METRIC	THIRD ANGLE PROJECTION	
						DRAWN BY KPHILLIPS		DATE 2005/28/07	
						CHECKED BY BREED		DATE 2005/28/07	
						APPROVED BY DDOYE		DATE 2005/28/07	
		ANGULAR $\pm 1/2^\circ$		MATERIAL NO. SEE TABLE		DOCUMENT NO. SD-74547-100		SHEET NO. 3 OF 4	
DRAFT WHERE APPLICABLE MUST REMAIN WITHIN DIMENSIONS				THIS DRAWING CONTAINS INFORMATION THAT IS PROPRIETARY TO MOLEX INCORPORATED AND SHOULD NOT BE USED WITHOUT WRITTEN PERMISSION					

9 8 7 6 5 4 3 2 1

10 9 8 7 6 5 4 3 2 1

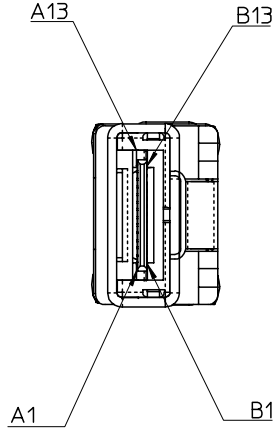

P1	GND	A1		B1	GND	P2
	Rx 0+	A2	←	B2	Tx 0+	
	Rx 0-	A3	←	B3	Tx 0-	
	GND	A4		B4	GND	
	Rx 1+	A5	←	B5	Tx 1+	
	Rx 1-	A6	←	B6	Tx 1-	
	GND	A7		B7	GND	
	Rx 2+	A8	←	B8	Tx 2+	
	Rx 2-	A9	←	B9	Tx 2-	
	GND	A10		B10	GND	
	Rx 3+	A11	←	B11	Tx 3+	
	Rx 3-	A12	←	B12	Tx 3-	
	GND	A13		B13	GND	
GND	B1		A1	GND		
Tx 0+	B2	→	A2	Rx 0+		
Tx 0-	B3	→	A3	Rx 0-		
GND	B4		A4	GND		
Tx 1+	B5	→	A5	Rx 1+		
Tx 1-	B6	→	A6	Rx 1-		
GND	B7		A7	GND		
Tx 2+	B8	→	A8	Rx 2+		
Tx 2-	B9	→	A9	Rx 2-		
GND	B10		A10	GND		
Tx 3+	B11	→	A11	Rx 3+		
Tx 3-	B12	→	A12	Rx 3-		
GND	B13		A13	GND		

IPASS™ IS A TRADEMARK OF MOLEX

ENTER DESCRIPTION EC NO: USY2006-0151 DRWN:KPHILLIPS 2006/02/06 CHK'D:B. REED 2006/02/06 APPR:DDOYE 2006/02/24	QUALITY SYMBOLS ▽=0 ▽=0	GENERAL TOLERANCES (UNLESS SPECIFIED)		DIMENSION STYLE MM ONLY	SCALE 1:1	DESIGN UNITS METRIC	THIRD ANGLE PROJECTION	
		4 PLACES ± --- ± ---	DRAWN BY KPHILLIPS	DATE 2005/28/07	TITLE I-PASS 26 CKT EXTERNAL CABLE ASSEMBLY, PLUG TO PLUG			
		3 PLACES ± --- ± ---	CHECKED BY BREED	DATE 2005/28/07	MOLEX INCORPORATED			
		2 PLACES ± 0.13 ± --- 1 PLACE ± 0.25 ± --- ANGULAR ±1/2°	APPROVED BY DDOYE	DATE 2005/28/07	MATERIAL NO. SEE TABLE	DOCUMENT NO. SD-74547-100	SHEET NO. 4 OF 4	
DRAFT WHERE APPLICABLE MUST REMAIN WITHIN DIMENSIONS		THIS DRAWING CONTAINS INFORMATION THAT IS PROPRIETARY TO MOLEX INCORPORATED AND SHOULD NOT BE USED WITHOUT WRITTEN PERMISSION						

9 8 7 6 5 4 3 2 1