

Introduction: DIPLOMAT Cases, Towers and Caseframes

DIPLOMAT 19" AND 10½" CASES

DIPLOMAT 19" and 10½" cases are designed for the direct mounting of subracks and chassis to IEC 297-1 and DIN 41494. They are strong and lightweight, with inherent EMC protection due to their metal construction. They have also obtained an IP rating of 30. A new fan plinth design has improved the cooling performance of this unit significantly, results of which are published on page 4 of this brochure. A very large range of ex-stock sizes are available and can now be assembled to order and despatched with accessories fitted. Due to the nature of its construction, this unit is also easily customised, so please ask our Sales Office for more details.

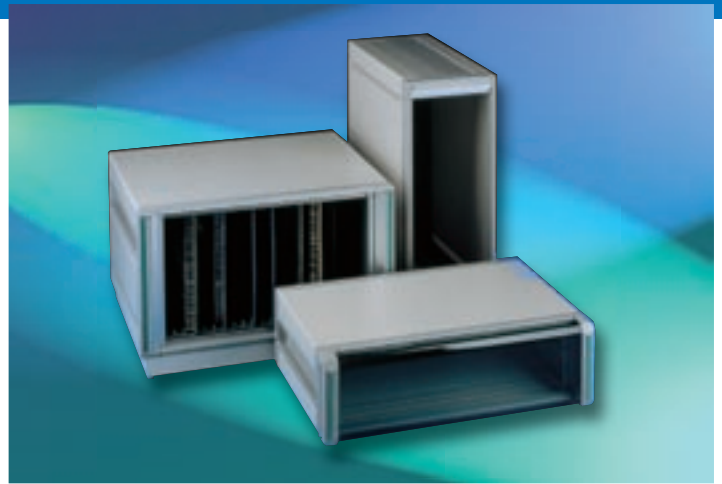

DIPLOMAT 19" Cases

DIPLOMAT-RF 19" AND 10½" CASES

DIPLOMAT-RF 19" and 10½" cases are designed to suit applications requiring a higher level of EMC protection to shield sensitive electronic equipment.

The significantly higher level of protection is achieved by selectively placing BeCu fingers around joints in the enclosure to attain the level of EMC protection required. Because the fingers can be added or removed easily, the level of shielding may be altered to find the most cost-effective solution.



DIPLOMAT-RF 19" Cases

DIPLOMAT COMPUTER TOWERS

DIPLOMAT Computer Towers are designed for direct mounting of subracks or chassis and conform to IEC 297-1 and DIN 41494. The towers are available in two widths and can accept up to 12U of subracks or chassis. All units are supplied assembled.



DIPLOMAT Computer Tower

DIPLOMAT CASEFRAMES – EUROCARD COMPATIBLE

DIPLOMAT caseframes are designed for the direct mounting of circuit boards and modules to IEC 297-3, DIN 41494 Pt. 5 and BS 5954. They are available with EMC conversion kits which give high levels of attenuation. The basic unit however will also afford EMC protection due to its metal construction.

The cooling performance of this unit has also been improved, especially in the slot 1 region of VME systems, where hot cards are often situated. These units are supported by a range of accessories which increase its versatility and application environment. These units are also rated at IP30.



DIPLOMAT Caseframes

DIPLOMAT Case Cooling

NEW AND IMPROVED COOLING PERFORMANCE

The DIPLOMAT range of enclosures has improved cooling performance in both the standard and fan plinth versions. The fan plinth version has a wider plinth with an increased ventilation surface area to increase the volume of air flow. The plinth can either act as a chamber for air collection when fans are mounted on the rear panel of the unit (pull through air flow) or can be used to mount fans directly hence employing a push method of cooling. Fans can be mounted in the plinth and on the rear panel employing a push-pull method of cooling.

Ducting plates can be placed in the plinth to give additional direction to the air flow, concentrating the flow towards hot cards or components. The level of cooling performance achieved will depend on a number of variables, such as the internal component architecture and hot component positioning. A test was set up where a 6U DIPLOMAT unit 19" wide was fitted with a populated card frame, 220mm boards to a 6U full width backplane, and air flow indicating componentry. Two 95CFM fans were mounted on the rear panel and a standard ducting plate used to direct the air across the cards, the results recorded are shown below.

The results below were measurements of air velocity taken from the standard DIPLOMAT with new 38mm deep plinth with ducting plate, and 2 x 95 CFM fans mounted on the rear panel. The top panel was non ventilated.

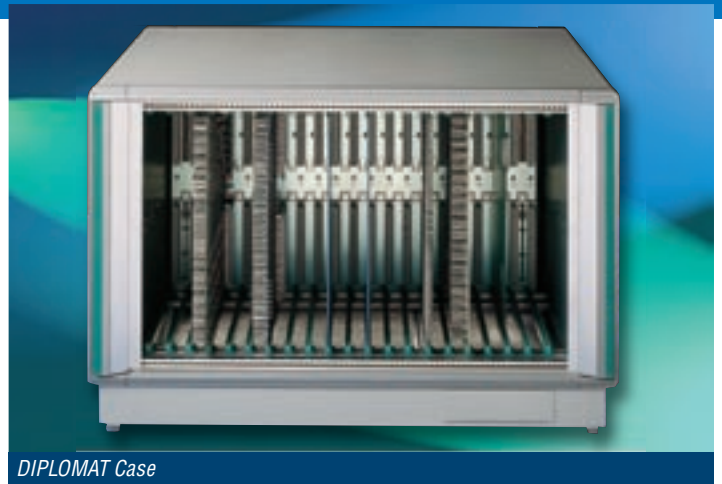

DIPLOMAT Case

Air flow

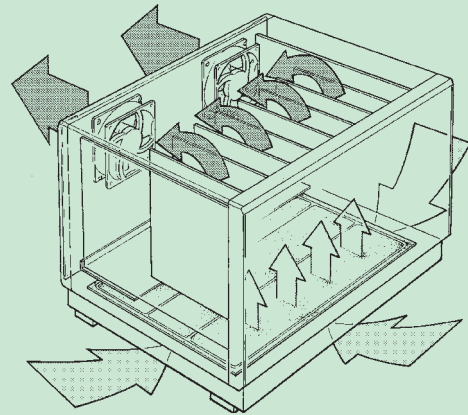

Velocity M/S

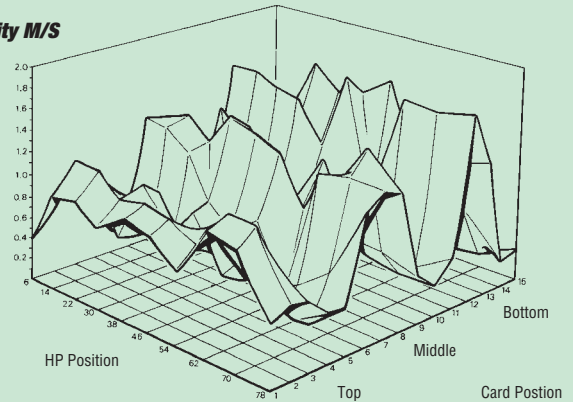

DIPLOMAT Airflow Velocities

2 x 95CFM Rear Panel (New Style Plinth)

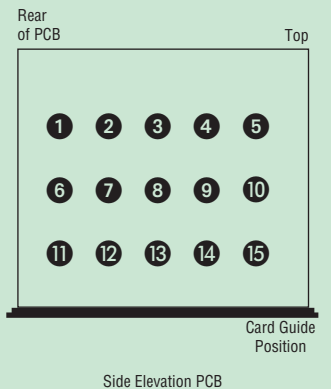
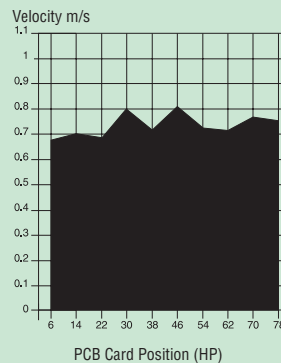

DIPLOMAT Case EMC and IP Sealing

DIPLOMAT SHIELDING EFFECTIVENESS RESULTS

The shielding effectiveness results shown have been measured in APW's EMC test facility using a generic test procedure adapted for smaller enclosures.

Isolated from ambient electromagnetic interference within a screened room, magnetic and electric field signals are radiated at discrete frequencies inside the enclosure under test. Field strengths at positions around the enclosure are compared with equivalent control measurements to determine the signal attenuation by the enclosure at each frequency.

Shielding effectiveness may vary around the enclosure.

EMC PROTECTION

The graph shows typical attenuation figures achieved for a 3U 19" DIPLOMAT case, which has been fitted with standard front and rear panels. The performance achieved shows that in both the E and the H field the unit will provide fairly high levels of attenuation across a broad frequency band.

The DIPLOMAT range of enclosures have undergone a series of technical performance tests, conducted in accordance with MIL-STD 285, modified where necessary due to the nature of the enclosure. The results shown are worst case and units were not fitted with any additional metalwork. The performance of the units may be improved when internal chassis and EMC front panels are included.

IP PROTECTION

The DIPLOMAT range was also tested for the ingress of dust using a standard BSI probes. The unit passed a test which gives an IP rating of 30. The unit was not tested for the ingress of water.

SHIELDING EFFECTIVENESS FOR 3U x 422 DIPLOMAT 19" CASE

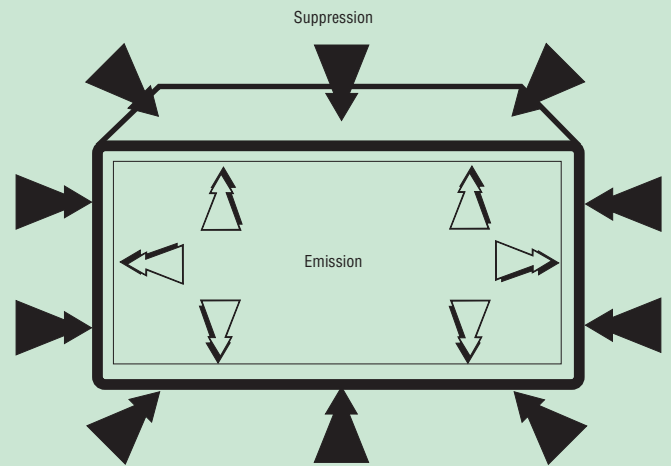
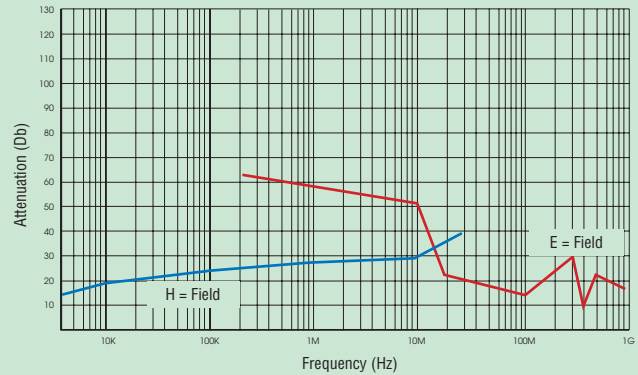

IP	3	0
INDEX OF PROTECTION	DUST PROTECTION	WATER PROTECTION

3	Protection against small foreign bodies	Protection of persons from touching active or internal moving parts with tools, or similar, thicker than 2,5mm. Protection of the object from access of solid foreign matter larger than 2,5mm in diameter.
0	No protection	No special protection

DIPLOMAT Cases: Overview and accessories index

A superb range of robust cases for direct mounting of 42HP or 84HP subracks and 10½" or 19" chassis to IEC 297-1 and DIN 41494.

Features

- Supplied assembled
- Superb modern styling
- Robust metal construction
- Conforms to IEC 297-1 and DIN 41494
- Quick release top and bottom covers
- Horizontal, vertical tower and plinth versions available.
- Front trims conceal 19" fixings
- Very large range of standard ex-stock sizes
- Easy customisation
- Painted in modern colour combination of light and mid grey to BS4800-00A01 and BS4800-00A05

APPLICATIONS

The DIPLOMAT 19" and 10½" cases are designed to provide stylish, robust, yet economical solutions for housing electronic systems.

The standard cases are ideal for 10½" or 19" (42HP or 84HP) equipment used in either office or industrial applications. Vertical tower versions are designed as floor standing units suitable for convenient positioning either under or next to a desk.

Items to be ordered as accessories

Description	Page
Transparent doors	10
Heavy duty carry handles	10
Feature front panels	11
19" and 10½" front panels	11
Front bezel trims	11
Rear panels	12
Fan accessories	12
Cable tidy	12
Bump down foot	13
Rear bezel trims	13
Earth continuity kit	14
Chassis supports	14
Chassis trays	14

WOULD YOU LIKE THEM ADDED TO THE BASIC UNIT?

We can add your accessories to the DIPLOMAT case and despatch as one unit. Please refer to the DIPLOMAT Case Configurator on page 15 or contact our Sales Office on 01489 774500 for details.

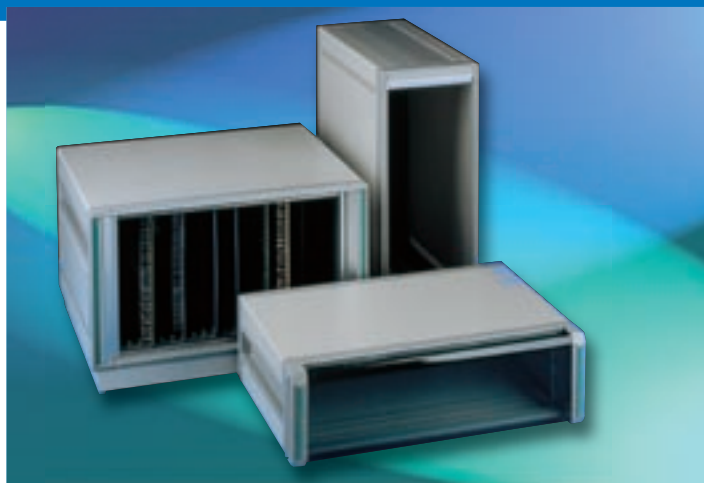

DIPLOMAT

- 1 Front trims (order as accessories)
- 2 Tilt up feet
- 3 Ventilation plinth
- 5 Side infill panel
- 6 Side handle extrusion
- 7 Top cover
- 8 Front/rear bezel assemblies
- 9 Side extrusion (4U, 6U & 9U)

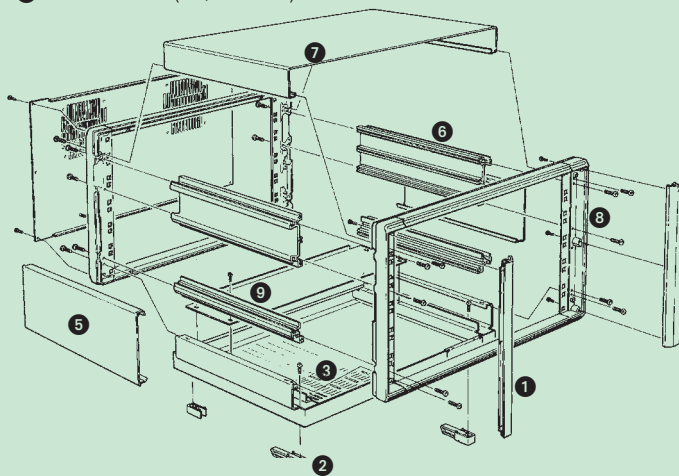

Recess trim

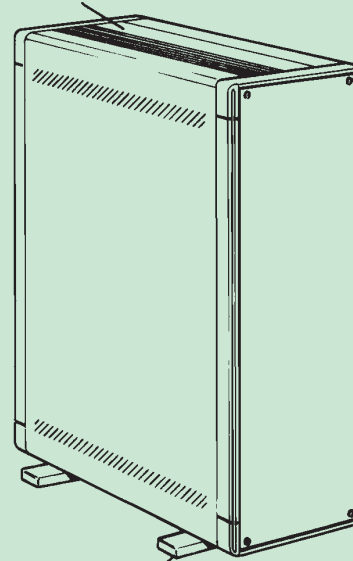

Foot assembly

DIPLOMAT Cases 3U and 4U horizontal versions

HORIZONTAL CASES WITH OR WITHOUT PLINTH

The standard horizontal DIPLOMAT cases are available in four heights, two widths and four depths, and are supplied ready assembled.

Contents of kit

Description	Qty	Material/Finish
Top cover	1	0.9mm Zintec coated steel
Bottom cover (or plinth)	1	0.9mm Zintec coated steel
Handle extrusion	2	Aluminium alloy extrusion
Side extrusions (4U only)	4	Aluminium alloy extrusion
Bezels	2	Aluminium alloy castings
Feet (2 tilting)	4	ABS plastic
Finish		Textured electrostatic epoxy paint
Colour: Top/bottom covers, plinths		Light grey BS4800-00A01
Front and rear bezels, side handles and 4U side extrusions		Mid grey BS4800-00A05

Order separately

Description	Page
Transparent doors and heavy duty carry handle	10
Front panels and front bezel trims	11
Rear panels, cable tidy and fan accessories	12
Rear bump down feet and rear bezel trims	13
Earth continuity kits, chassis supports and chassis trays	14

STANDARD 19" CASES – Supplied assembled

Ordering information

Height (mm)	Width	Ext depth	Max int depth	Dimensions			Order code
				A	B	C	
3U (161,85)	19"	322	277	450	134,85	17	760-236562
		422	377	450	134,85	17	760-236563
		522	477	450	134,85	17	760-236564
4U (206,30)	19"	322	277	450	179,30	17	760-236565
		422	377	450	179,30	17	760-236566
		522	477	450	179,30	17	760-236567

19" VENTILATION PLINTH DIPLOMATS – Supplied assembled

(with air filtration built in as standard)

Ordering information

Height (mm)	Width	Ext depth	Max int depth	Dimensions					Order code
				A	B	C	D	E	
3U (161,85)	19"	322	277	450	134,85	39.5	506.4	287	760-236579
		422	377	450	134,85	39.5	506.4	387	760-236580
		522	477	450	134,85	39.5	506.4	487	760-236581
4U (206,30)	19"	322	277	450	179,30	39.5	506.4	287	760-236582
		422	377	450	179,30	39.5	506.4	387	760-236583
		522	477	450	179,30	39.5	506.4	487	760-236584

10½" HALF WIDTH CASES

Ordering information

Height (mm)	Width	Ext depth	Max int depth	Dimensions			Order code
				A	B	C	
3U (161,85)	10.5"	322	277	234	134,85	17	760-236575
		422	377	234	134,85	17	760-236576
4U (206,30)	10.5"	322	277	234	179,30	17	760-236577
		422	377	234	179,30	17	760-236578



DIPLOMAT 19" Cases 3U and 4U horizontal versions

3U and 4U Horizontal Versions

Ventilation plinth and gland plates

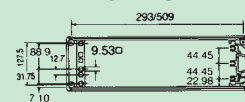
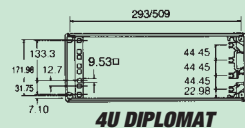
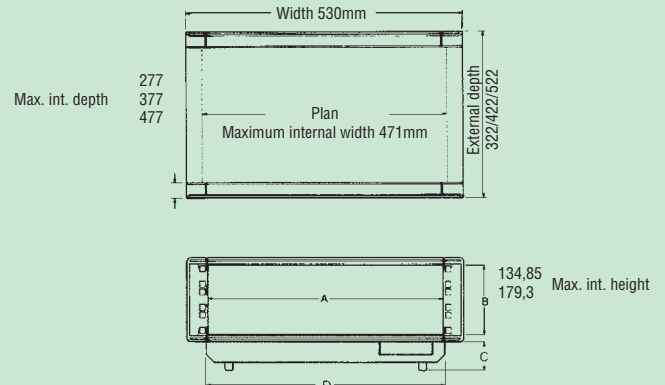

Gland Plates

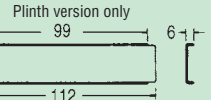

4U Side Extrusion

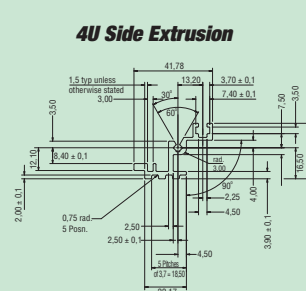

Handle Extrusion

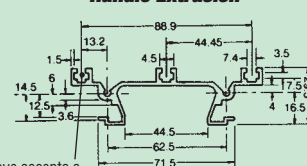

Note: Groove accepts a STD M4 size nut.

Bezel Section

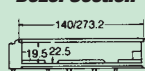

Ventilation Plinth

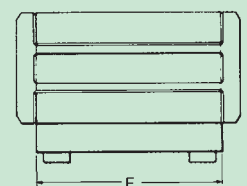

DIPLOMAT Cases 3U and 4U vertical versions

The vertical DIPLOMAT cases offer a stylish packaging solution for office based computer systems located either on or under the operators desk. For desk cases rubber inserts are provided to prevent the unit slipping on the desk surface.

Contents of kit

Description	Qty	Material/Finish
Handle	1	Aluminium alloy extrusion
Vertical feet assemblies	2	ABS plastic/aluminium extrusion
Ventilated side covers	2	0.9mm Zintec coated steel
Handle extrusions	2	Aluminium alloy extrusion
Side extrusions (4U)	4	Aluminium alloy extrusion
Handle infill	1	0.9mm Zintec coated steel
Bezels	2	Aluminium alloy castings
Finish		Textured electrostatic epoxy paint
Colour: Side covers		Light grey BS4800-00A01
Front and rear bezels, side handles and extrusions, infills and feet		Mid grey BS4800-00A05

Order separately

Description	Page
Transparent doors and heavy duty carry handle	10
Front panels and front bezel trims	11
Rear panels, cable tidy and fan accessories	12
Rear bump down feet and rear bezel trims	13
Earth continuity kits, chassis supports and chassis trays	14

VERTICAL 19" CASES – Supplied assembled

Ordering information

Height (mm)	Width depth	Dimensions				Order code
		Ext depth	Max int	A	B	
3U (161,85)	19"	422	377	450	134,85	760-236635
		522	477	450	134,85	760-236636
4U (206,30)	19"	422	377	450	179,30	760-236637
		522	477	450	179,30	760-236638

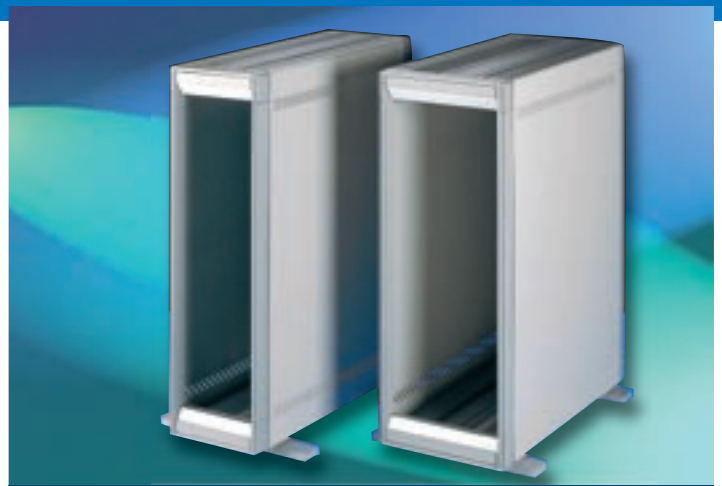
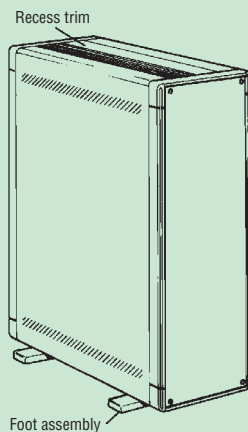

DIPLOMAT 19" Cases 3U and 4U vertical versions

3U and 4U Vertical Cases

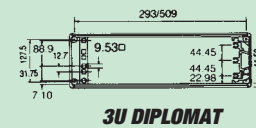
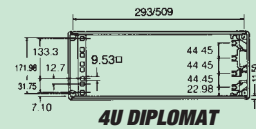
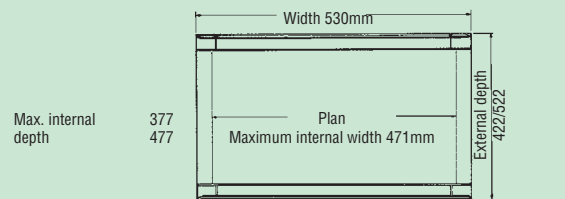

4U Side Extrusion

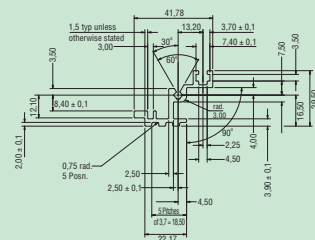

Note: Groove accepts a STD M4 size nut.

Bezel Section

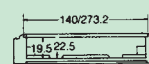

DIPLOMAT Cases 6U and 9U horizontal versions

6U and 9U horizontal cases are available in either standard or plinth versions. Typical cooling performance characteristics for a loaded case can be found on page 4, which also demonstrates the likely air flow path in this scenario.

Contents of kit

Description	Qty	Material/Finish
Top cover	1	0.9mm Zintec coated steel
Bottom cover (or plinth)	1	0.9mm Zintec coated steel
Handle extrusions	2	Aluminium alloy extrusion
Side extrusions	2	Aluminium alloy extrusion
Bezels	2	Aluminium alloy casting
Side infills	2	0.9mm Zintec covers, coated steel
Feet (2 tilting)	4	ABS Plastic
Finish		Textured electrostatic epoxy paint
Colour: Top/bottom covers, plinths and side infills		Light grey BS4800-00A01
Front and rear bezels, side handles and side extrusions		Mid grey BS4800-00A05

Order separately

Description	Page
Transparent doors and heavy duty carry handle	10
Front panels and front bezel trims	11
Rear panels, cable tidy and fan accessories	12
Rear bump down feet and rear bezel trims	13
Earth continuity kits, chassis supports and chassis trays	14

STANDARD 19" DIPLOMAT CASES – Supplied assembled

Ordering information

Height	Width	Ext depth	Dimensions				Order code
			Max int depth	A	B	C	
6U	19"	322	277	450	268,20	17	760-236568
		422	377	450	268,20	17	760-236569
		522	477	450	268,20	17	760-236570
		622	577	450	268,20	17	760-236573
9U	19"	422	377	450	401,55	17	760-236571
		522	477	450	401,55	17	760-236572
		622	577	450	401,55	17	760-236574

19" VENTILATION PLINTH DIPLOMATS – Supplied assembled

(with air filtration built in as standard)

Ordering information

Height (mm)	Width	Ext depth	Max int depth	Dimensions					Order code
				A	B	C	D	E	
6U (295,20)	19"	322	277	450	268,20	39.5	506.4	308	760-236585
		422	377	450	268,20	39.5	506.4	408	760-236586
		522	477	450	268,20	39.5	506.4	508	760-236587
		622	577	450	268,20	39.5	506.4	608	760-236590
9U (428,55)	19"	422	377	450	401,55	39.5	506.4	408	760-236588
		522	477	450	401,55	39.5	506.4	508	760-236589
		622	577	450	401,55	39.5	506.4	608	760-236591

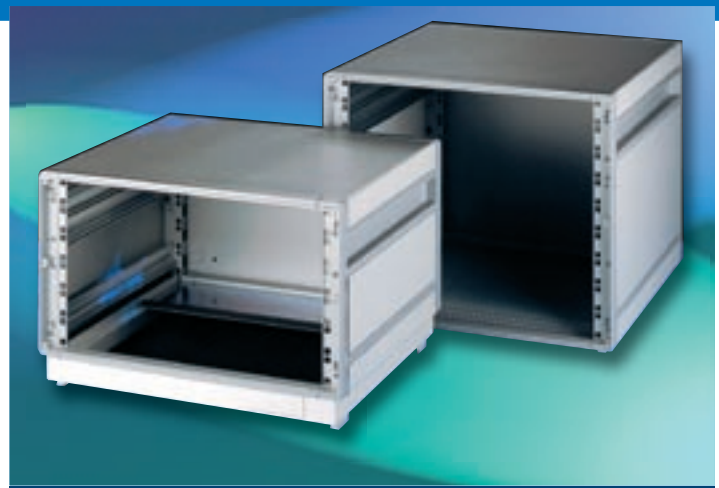

DIPLOMAT 19" Cases 6U and 9U horizontal versions

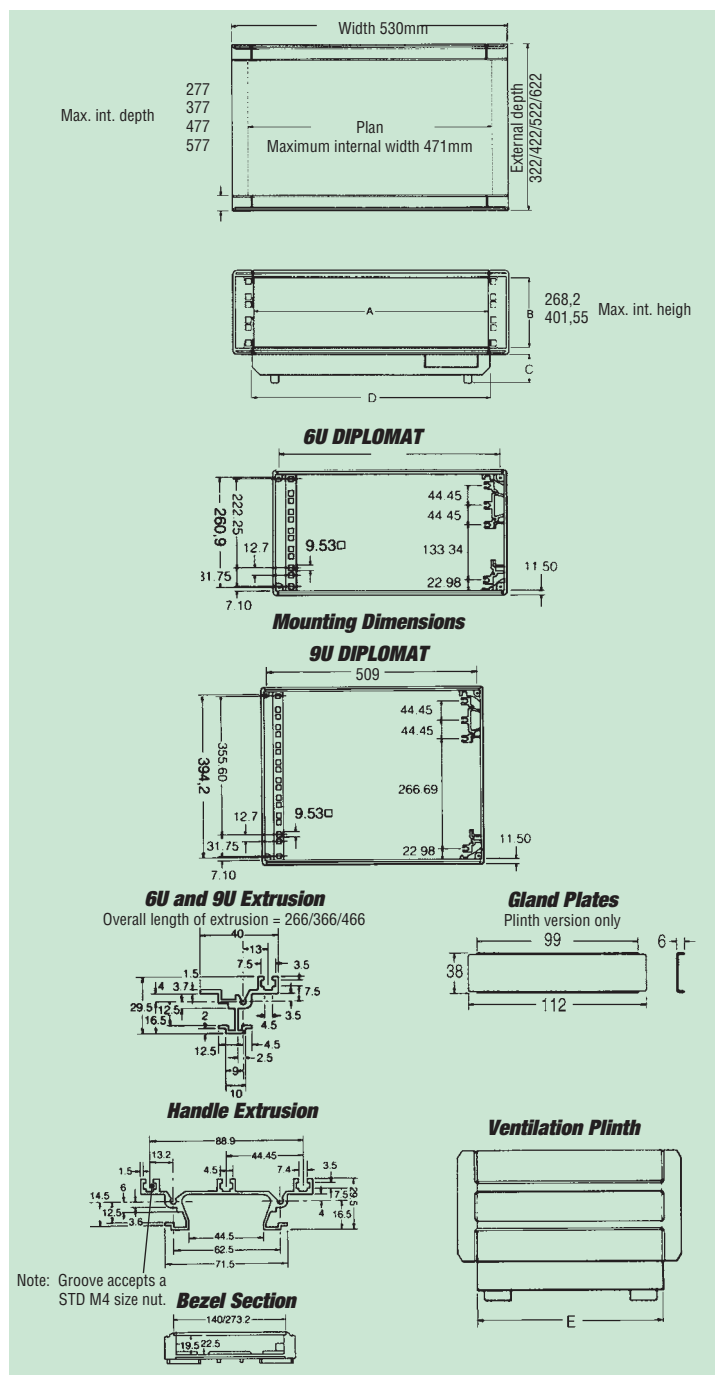

DIPLOMAT Cases accessories

TRANSPARENT DOORS

Manufactured from strong yet lightweight materials this new transparent door design offers not only security but styling to the DIPLOMAT 19" enclosure.

All doors are lockable and allow sufficient space inside to mount components on front panels without causing interference. All doors are supplied with an integral colour highlight strip.

Flamability rating - BS476 class 3/UL94-HB

Contents of kit

Description	Qty.	Material/Finish
Door assembly	1	3mm Acrylic panel (tint 901) with mid grey ABS corner mouldings (BS4800-00A05)
Highlight trim	2	PVC, colour Lincoln Green
Lock trim	1	Aluminium extrusion, satin anodised
Plain trim	1	Aluminium extrusion, satin anodised
Set of keys	1	
Set of fixings	1	

Ordering information

Height	Width	Description	Order code
3U	10½"	Horizontal hinge	760-236832
4U	10½"	Horizontal hinge	760-236833
3U	19"	Horizontal hinge	760-236827
		Vertical hinge	760-240994
4U	19"	Horizontal hinge	760-236828
		Vertical hinge	760-240995
6U	19"	Vertical hinge	760-236829
9U	19"	Vertical hinge	760-236831

HEAVY DUTY CARRY HANDLE - 3U AND 4U CASES ONLY

This heavy duty handle is designed to visually coordinate with the DIPLOMAT cases. It is suitable for 3U and 4U cases and will accept loads of up to 300N. The handle has a press button mechanism which locks in increments of 30°. This allows the cases to be easily carried or tilted on a work surface. A template is supplied with the kit for easy drilling and to assist location in the side extrusions.

Contents of kit

Description	Qty.	Material/finish
Side arms and location mouldings	2	Polycarbonate, mid grey
Cross bar	1	Alu. alloy etch and clear anodise
Fixing screws		

Ordering information

Description	Order code
Case Carry Handle 10½"	60-202675
19"	60-202673

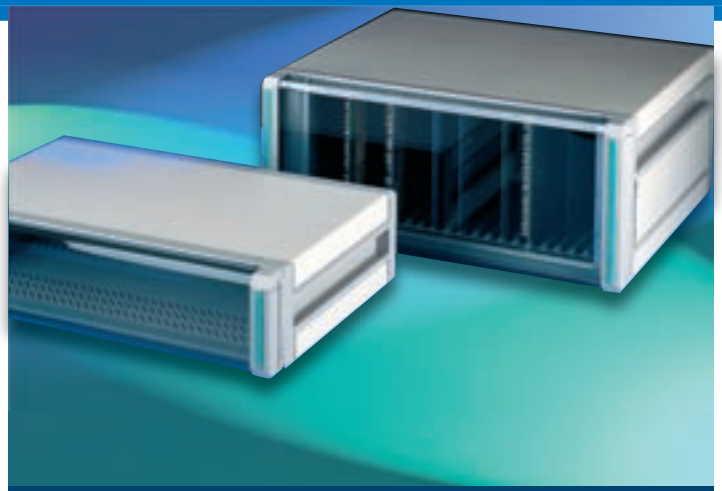

Transparent doors

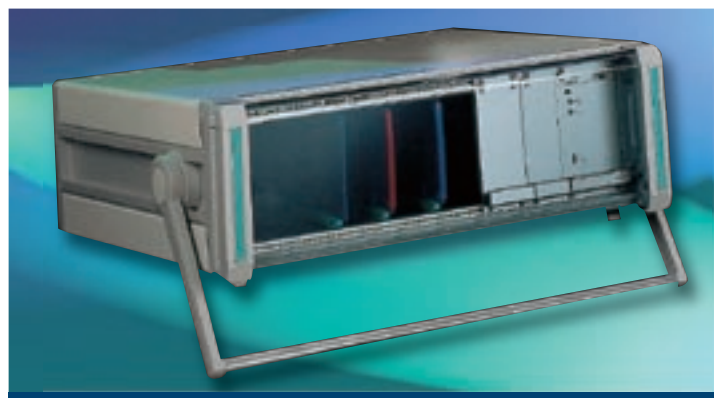
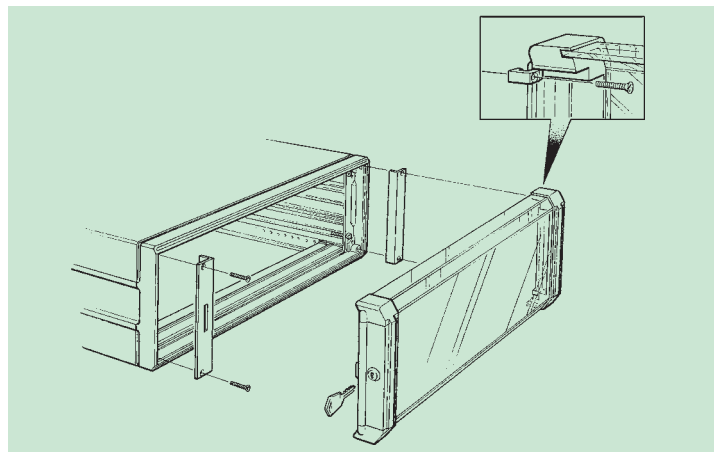

Heavy duty carry handle

DIPLOMAT Cases accessories

FEATURE FRONT PANELS

Available in addition to the range of standard 19" front panels, these are unique to the DIPLOMAT case. Manufactured in 3mm etched and anodised aluminium with a high quality surface finish they provide a clean and very attractive frontal appearance. They may be used both on the front and rear of the case and are fitted into the bezel in place of the trims, and in front of the 19" fixing facilities.

Ordering information

Case Size		Panel dimensions		Order code
Height	Width	Height	Width	
3U	10½"	138,5	304	60-39272
	19"	138,5	520	60-39268
4U	10½"	183	304	60-39273
	19"	183	520	60-39269
6U	19"	272	520	60-39270

10½" AND 19" FRONT PANELS

Standard 19" (IEC 297-1, DIN 41494 pt1) front panels are available in satin anodised aluminium of 3mm thickness.

Ordering information

Height	Width		Order code
1U	19"	(482mm)	50-0767
2U	10½"	(266,7mm)	50-0763
	19"	(482mm)	50-0768
3U	10½"	(266,7mm)	50-0764
	19"	(482mm)	50-0769
4U	10½"	(266,7mm)	50-0765
	19"	(482mm)	50-0770
6U	19"	(482mm)	50-0772
9U	19"	(482mm)	50-24284

FRONT BEZEL TRIMS

These provide an attractive finish to the DIPLOMAT cases when the equipment has been installed. They are available in two versions; two-part highlighted and two-part plain.

The highlighted versions are mounted from the front of the unit for easy access and supplied with the standard highlight colour (Pantone green).

The plain version is mounted from the rear of the bezel, providing a clean fronted appearance and offering additional security.

Ordering information

Height	Description	Order code
3U	Plain two part	760-236865
	Colour two part	760-238510
4U	Plain two part	760-236866
	Colour two part	760-238511
6U	Plain two part	760-236867
	Colour two part	760-238512
9U	Plain two part	760-236868
	Colour two part	760-238513



Feature front panels

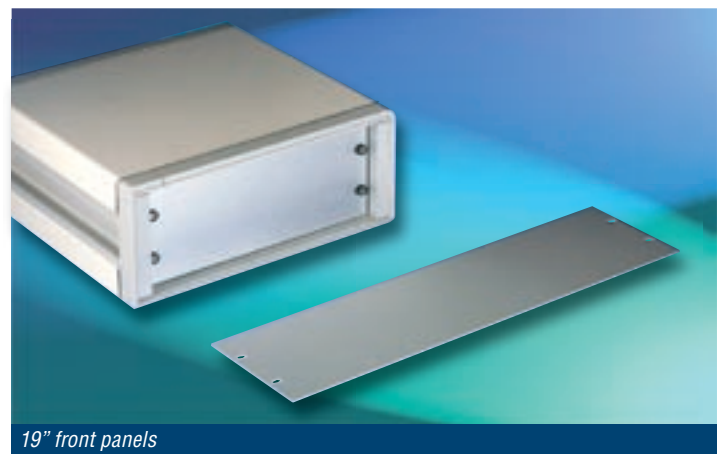

19" front panels



Front bezel trims

DIPLOMAT Cases accessories

10½" AND 19" REAR PANELS

These steel rear panels are available in two versions – standard ventilated or fan ventilated – and two widths to suit 10½" and 19" DIPLOMAT Cases. The top and bottom covers of the enclosure can be quickly removed without the need to remove any panels. This is achieved by the provision of holes in the rear panel to permit easy access to the cover securing screws.

The standard ventilated versions are supplied pre-punched with obround holes across the full width of the rear panel, providing a safe passage of air through the case.

The fan ventilated versions are supplied with pre-punched vent areas with the relevant fixing holes to mount 120mm square fans. These panels are particularly suited to applications requiring forced cooling to aid air throughput.

Contents of kit

Description	Qty.	Material/finish
Rear panel	1	0,9mm steel, painted mid gray BS4800-00A05
Hole plugs	4	Natural nylon
Fixing screws		

Ordering information

Description: Standard ventilated panels

Height	Width	Order code
3U	10½"	760-236628
	19"	760-236623
4U	10½"	760-236629
	19"	760-236624
6U	19"	760-236625
9U	19"	760-236627

Description: Fan ventilated panels

Height	Width	Fan positions	Order code
3U	10½"	1	760-236876
	19"	1	760-236872
4U	10½"	1	760-236877
	19"	2	760-236873
6U	19"	2	760-236874
9U	19"	3	760-236875

FAN PANEL ACCESSORIES – 10½" AND 19" CASE COMPATIBLE

Ordering information

Description	Order code
120mm 220V AC 50Hz fan	28-238116
80mm 220V AC 50Hz fan	28-42355
120mm Finger guard	28-202490
80mm Finger guard	28-42366
Fan fixing kit	28-43872
Fan connection lead	28-241569

REAR CABLE TIDY – 10½" AND 19" CASE COMPATIBLE

The rear cable tidy allows power cables to be conveniently and tidily stored. It is supplied as a kit of two mouldings which are attached directly to the pre-punched rear panels (both types).

Ordering information

Description	Order code
Rear cable tidy kit	517-203357

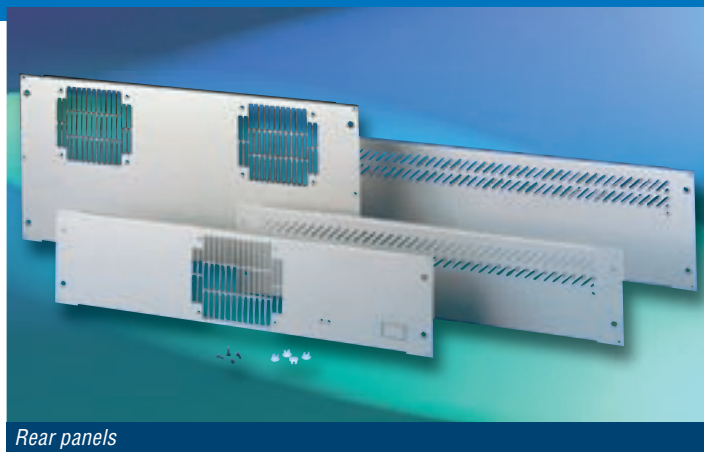

Rear panels



Fan panel accessories



Rear cable tidy

DIPLOMAT Cases accessories

REAR BUMP DOWN FEET – 3U CASES ONLY

This useful bump down foot accessory allows portable instruments to be placed safely on rugged surfaces without causing damage to the unit itself. The foot assembly also acts as a cable wrap to conveniently store power cables. Access to the DIPLOMAT interior can be gained via securing screws in the foot moulding, which when unscrewed, will release the top and base covers. These are suitable for 3U units only.

Contents of kit

Description	Qty.	Material/Finish
Set of mouldings	2 pairs	Polycarbonate, mid grey BS4800-00A05
Support brackets	2	2mm steel, mid grey BS4800-00A05
Rubber inserts	4	Rubber, black
Fixing screws	4	

Ordering information

Description	Order code
Bump down feet	760-238388



Rear bump down feet

REAR BEZEL TRIMS – 10½" AND 19" CASE COMPATIBLE

These can be used to hide the case fixing screws when the DIPLOMAT rear panel is not used.

Similar in design to the front trims, but attached from the outside, they allow easy access without having to remove the covers.

These trims may also be used as an alternative to the front trims where access is required. Supplied as a pair of trims.

Contents of kit

Description	Qty.	Material/Finish
Rear bezel trims	1 pair	Aluminium alloy extrusion mid grey BS4800-00A05
Fixing screws		

Ordering information

Case height	Order code
3U	60-54745
4U	60-54746
6U	60-54747



Rear bezel trims

DIPLOMAT Cases accessories

EARTH CONTINUITY KIT – 10½" OR 19" CASE COMPATIBLE

The earth continuity kit provides all the cables and fixings required to give complete earth continuity throughout the case. This single kit is suitable for all sizes of DIPLOMAT.

Contents of kit

Description	Qty
Earthing leads	5
Bolt-on spade connector	5
Earth bonding screw	5
M4 Pan head screw x 6LG DIN	5
M4 Hex nut (thin)	10
Instructions leaflet	1

Ordering information

Description	Order code
DIPLOMAT earth continuity kit	60-54598

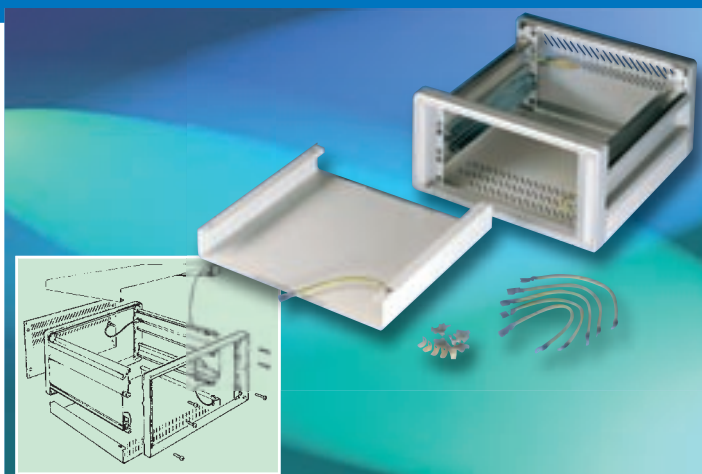

Earth continuity kit

CHASSIS SUPPORT KIT – 10½" OR 19" CASE COMPATIBLE

Chassis supports are available to provide additional support for 19" chassis or cardframes within the enclosures. These are assembled to the T slots in the side extrusions. Each kit comprises two runners and all necessary fixings.

Contents of kit

Description	Qty.	Material/finish
Chassis supports	2	1,2mm steel clear zinc plated
Fixing screws		

Ordering information

Description: Chassis support

Case Size		Dimensions			Order code
Width	Depth	A	B	Depth	
	322	467	451	256	60-43796
19" or 10½"	422	467	451	356	60-43797
	522	467	451	456	60-43798



Chassis tray kit

CHASSIS TRAY KIT – 19" CASES ONLY

A range of chassis trays are available which, when attached to the chassis support, provide a complete chassis assembly for mounting processor boards or other components.

A matrix of slots is provided in each tray so that it does not restrict airflow within the unit. This is especially important when used in a DIPLOMAT case with a ventilation plinth.

Contents of kit

Description	Qty.	Material/finish
Chassis tray	1	1,2mm steel clear zinc plated
Fixing screws		

Ordering information

Description: Chassis tray

Case Size			Dimensions				Order code
Width	Depth	Available int. width	C	D	E	F	
	322	448	5	67	21	18	60-43802
19"	422	448	5	67	30	21	60-43803
	522	448	5	67	40	18	60-43804

Note: Chassis supports must be ordered when fitting a chassis tray. Each kit includes a chassis tray and all necessary fixings.

