



TISP4290T3BJ, TISP4350T3BJ

BIDIRECTIONAL THYRISTOR OVERVOLTAGE PROTECTORS

TISP4xx0T3BJ Overvoltage Protector Series

MODEM Protection against:

- TIA/EIA-IS-968 Type A & B surge
- UL 60950, Clause 6. power cross
- CSA 22.2 No. 60950, Clause 6. power cross

Low Differential Capacitance 23 pF typ.

Ion-Implanted Breakdown Region

- Precise and Stable Voltage
- Low Voltage Overshoot Under Surge

Device	V _{DRM} V	V _(BO) V
'4290T3	220	290
'4350T3	275	350

Rated for International Surge Wave Shapes

Wave Shape	Standard	I _{PPSM} A
2/10	GR-1089-CORE	250
8/20	IEC 61000-4-5	250
10/160	TIA/EIA-IS-968	150
10/700	ITU-T K.20/.21/.45	120
9/720	TIA/EIA-IS-968	120
10/560	TIA/EIA-IS-968	100
10/1000	GR-1089-CORE	80

SMB Package (Top View)

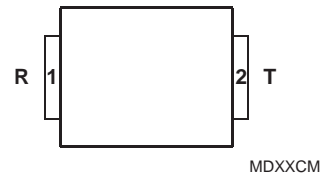

Device Symbol



..... **UL Recognized Component**

Description

These devices are designed to limit overvoltages on the telephone line. Overvoltages are normally caused by a.c. power system or lightning flash disturbances which are induced or conducted on to the telephone line. A single device provides 2-point protection and is typically used for the protection of 2-wire telecommunication equipment (e.g. between the Ring and Tip wires for telephones and modems). Combinations of devices can be used for multi-point protection (e.g. 3-point protection between Ring, Tip and Ground).

The protector consists of a symmetrical voltage-triggered bidirectional thyristor. Overvoltages are initially clipped by breakdown clamping until the voltage rises to the breakover level, which causes the device to crowbar into a low-voltage on state. This low-voltage on state causes the current resulting from the overvoltage to be safely diverted through the device. The high crowbar holding current prevents d.c. latchup as the diverted current subsides. These protectors are guaranteed to voltage limit and withstand the listed lightning surges in both polarities.

After a TIA/EIA-IS-968 (replaces FCC Part 68) Type A surge the equipment can be faulty, provided that the fault mode causes the equipment to be unusable. There are two wave shapes used: 10/160 for longitudinal surges and 10/560 for metallic surges. For modems with a TISP4350T3BJ connected between the Ring and Tip wires (and without overvoltage protection to ground), the longitudinal 10/160 applied to both Ring and Tip will not activate the TISP4350T3BJ, giving an operational pass. The metallic 10/560 is applied between Ring and Tip wires and will operate the TISP4350T3BJ. As the TISP4350T3BJ has a current rating of 100 A, 10/560 it will survive the FCC Part Type A 100 A, 10/560 metallic surge giving an operational pass.

How to Order

Device	Package	Carrier	For Standard Termination Finish Order As	For Lead Free Termination Finish Order As
TISP4290T3BJ TISP4350T3BJ	BJ (SMB/DO-214AA J-Bend)	R (Embossed Tape Reeled)	TISP4290T3BJR TISP4350T3BJR	TISP4290T3BJR-S TISP4350T3BJR-S

*RoHS Directive 2002/95/EC Jan 27 2003 including Annex
 DECEMBER 2001 - REVISED FEBRUARY 2005
 Specifications are subject to change without notice.
 Customers should verify actual device performance in their specific applications.

TISP4xx0T3BJ Overvoltage Protector Series

BOURNS®

Description (Continued)

After a TIA/EIA-IS-968 Type B surge the equipment must be operational. As the TISP4350T3BJ has a current rating of 120 A, it will survive both Type B surges, metallic (25 A, 9/720) and longitudinal (37.5 A, 9/720), giving an operational pass to FCC Part 68 Type B surges.

The TIA/EIA-IS-968 B type ringer has voltages of 56.5 V d.c. and up to 150 V rms a.c., giving a peak voltage of 269 V. The TISP4350T3BJ will not clip the B type ringing voltage as it has a high impedance up to 275 V.

Absolute Maximum Ratings, $T_A = 25\text{ }^\circ\text{C}$ (Unless Otherwise Noted)

Rating	Symbol	Value	Unit
Repetitive peak off-state voltage (see Note 1)	V_{DRM}	± 220 ± 275	V
Non-repetitive peak on-state pulse current (see Notes 1 and 2)	I_{PPSM}	250 250 150 120 120 100 80	A
2/10 (Telcordia GR-1089-CORE, 2/10 voltage wave shape)			
8/20 (IEC 61000-4-5, combination wave generator, 1.2/50 voltage wave shape)			
10/160 (TIA/EIA-IS-968 (replaces FCC Part 68), 10/160 voltage wave shape)			
5/310 (ITU-T K.44, 10/700 voltage wave shape used in K.20/45/21)			
5/320 (TIA/EIA-IS-968 (replaces FCC Part 68), 9/720 voltage wave shape)			
10/560 (TIA/EIA-IS-968 (replaces FCC Part 68), 10/560 voltage wave shape)			
10/1000 (Telcordia GR-1089-CORE, 10/1000 voltage wave shape)		80	
Non-repetitive peak on-state current (see Notes 1, 2 and 3)	I_{TSM}	25 30 2.1	A
20 ms (50 Hz), full sine wave			
16.7 ms (60 Hz), full sine wave			
1000 s 50 Hz/60 Hz			
Initial rate of rise of on-state current, Linear current ramp, Maximum ramp value < 50 A	di_{T}/dt	500	A/ μs
Junction temperature	T_{J}	-40 to +150	$^\circ\text{C}$
Storage temperature range	T_{stg}	-65 to +150	$^\circ\text{C}$

NOTES: 1. Initially, the device must be in thermal equilibrium with $T_{\text{J}} = 25\text{ }^\circ\text{C}$.

2. These non-repetitive rated currents are peak values of either polarity. The surge may be repeated after the device returns to its initial conditions.
3. EIA/JESD51-2 environment and EIA/JESD51-3 PCB with standard footprint dimensions connected with 5 A rated printed wiring track widths. Derate current values at $-0.61\text{ } \%/^\circ\text{C}$ for ambient temperatures above $25\text{ }^\circ\text{C}$.

Overload Ratings, $T_A = 25\text{ }^\circ\text{C}$ (Unless Otherwise Noted)

Rating	Symbol	Value	Unit
Peak overload on-state current, a.c. power line cross tests UL 60950 (see Note 4)	$I_{\text{T(OV)M}}$	See Figure 4 for current versus time	A rms

NOTE 4: These electrical stress levels may damage the device silicon chip. After test, the pass criterion is either that the device is functional or, if it is faulty, that it has a short circuit fault mode. In the short circuit fault mode, the following equipment is protected as the device is a permanent short across the line. The equipment would be unprotected if an open circuit fault mode developed.

TISP4xx0T3BJ Overvoltage Protector Series

BOURNS®

Recommended Operating Conditions

Component		Min	Typ	Max	Unit
R _S	Series resistor for TIA/EIA-IS-968 (replaces FCC Part 68), 10/160 type A surge survival (T-G or R-G connection)	2.5			Ω
	Series resistor for TIA/EIA-IS-968 (replaces FCC Part 68), 10/560 type A surge survival	0			
	Series resistor for TIA/EIA-IS-968 (replaces FCC Part 68), 9/720 type B surge survival	0			
	Series resistor for GR-1089-CORE first-level surge survival	5			
	Series resistor for K.20, K.21 and K.45 1.5 kV, 10/700 surge survival	0			
	Series resistor for K.20, K.21 and K.45 coordination with a 400 V primary protector	6			

Electrical Characteristics, T_A = 25 °C (Unless Otherwise Noted)

Parameter	Test Conditions	Min	Typ	Max	Unit
I _{DRM} Repetitive peak off-state current	V _D = V _{DRM} T _A = 25 °C T _A = 85 °C			±5 ±10	μA
V _(BO) AC breakover voltage	dv/dt = ±250 V/ms, R _{SOURCE} = 300 Ω '4290T3 '4350T3			±290 ±350	V
I _(BO) AC breakover current	dv/dt = ±250 V/ms, R _{SOURCE} = 300 Ω			±0.8	A
V _T On-state voltage	I _T = ±5 A, t _W = 100 μs			±3	V
I _H Holding current	I _T = ±5 A, di/dt = +/-30 mA/ms	±0.15			A
dv/dt Critical rate of rise of off-state voltage	Linear voltage ramp, Maximum ramp value < 0.85 V _{DRM}	±5			kV/μs
I _D Off-state current	V _D = ±50 V T _A = 85 °C			±10	μA
C _{off} Off-state capacitance	f = 1 MHz, V _d = 1 V rms, V _D = 0, f = 1 MHz, V _d = 1 V rms, V _D = -1 V f = 1 MHz, V _d = 1 V rms, V _D = -2 V f = 1 MHz, V _d = 1 V rms, V _D = -50 V f = 1 MHz, V _d = 1 V rms, V _D = -100 V		54 48 43 20 16	65 58 52 24 19	pF

Thermal Characteristics

Parameter	Test Conditions	Min	Typ	Max	Unit
R _{θJA} Junction to free air thermal resistance	EIA/JESD51-3 PCB, T _A = 25 °C, (see Note 5)			115	°C/W
	265 mm x 210 mm populated line card, 4-layer PCB, I _T = I _{TSM(1000)} , T _A = 25 °C		52		

NOTE 5: EIA/JESD51-2 environment and PCB has standard footprint dimensions connected with 5 A rated printed wiring track widths.

Parameter Measurement Information

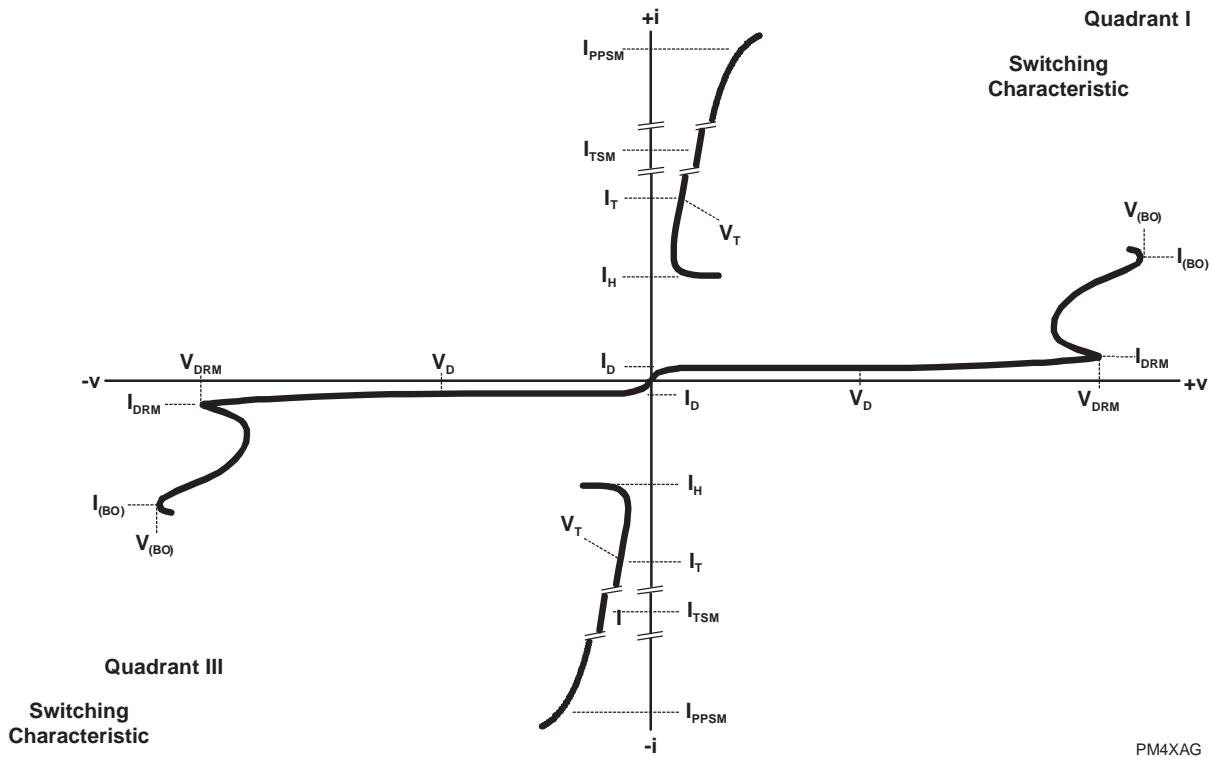

PM4XAG

Figure 1. Voltage-Current Characteristic for T and R Terminals
 All Measurements are Referenced to the R Terminal

Typical Characteristics

**NORMALIZED CAPACITANCE
vs
OFF-STATE VOLTAGE**

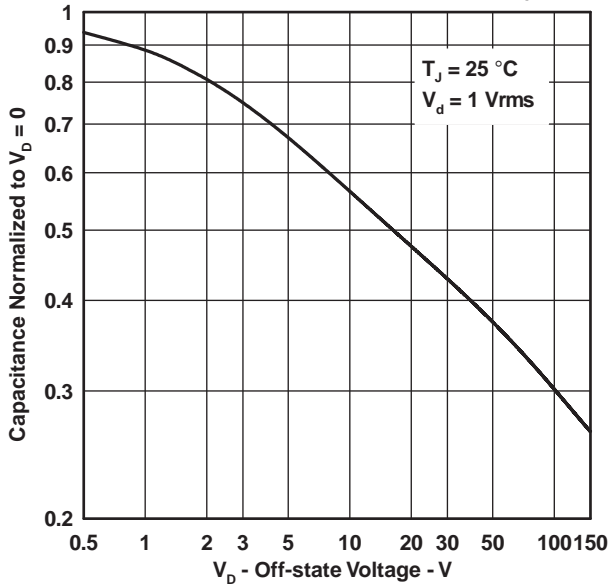

Figure 2.

**TYPICAL CAPACITANCE ASYMMETRY
vs
OFF-STATE VOLTAGE**

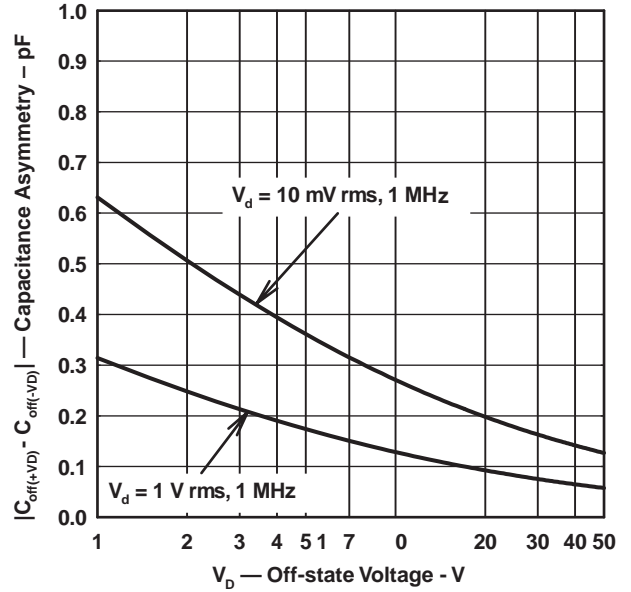

Figure 3.

Rating and Thermal Information

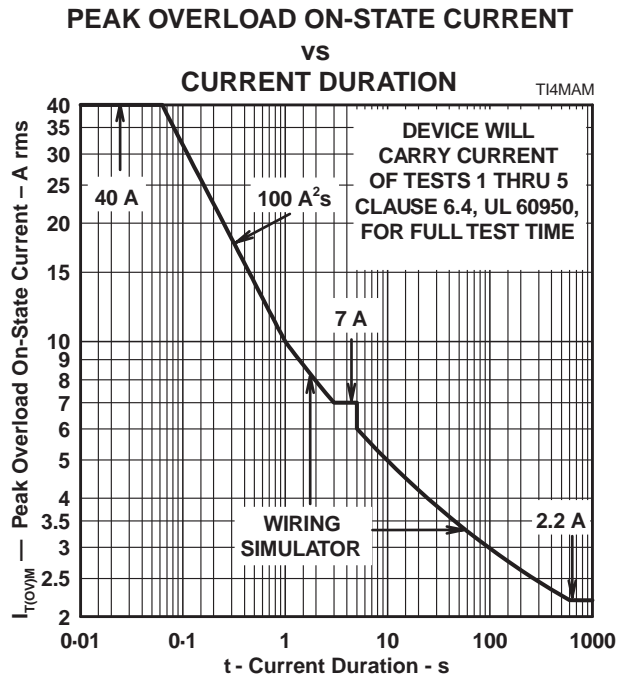
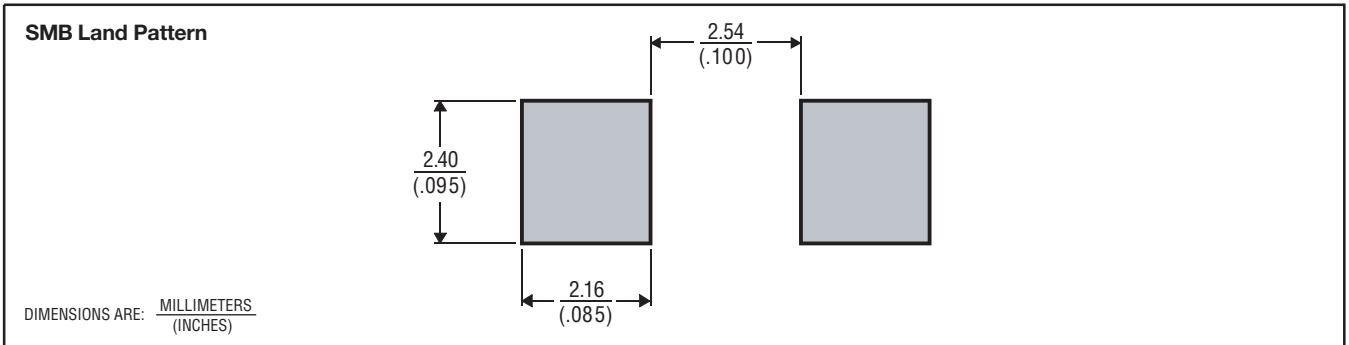

Figure 4. Peak Overload On-state Current against Duration

MECHANICAL DATA

Recommended Printed Wiring Land Pattern Dimensions



MDXXBID

Device Symbolization Code

Devices will be coded as below. As the device parameters are symmetrical, terminal 1 is not identified.

Device	Symbolization Code
TISP4290T3BJ	4290T3
TISP4350T3BJ	4350T3

Carrier Information

For production quantities, the carrier will be embossed tape reel pack. Evaluation quantities may be shipped in bulk pack or embossed tape.

Package	Carrier	Standard Quantity
SMB	Embossed Tape Reel Pack	3 000

MECHANICAL DATA

SMB (DO-214AA) Plastic Surface Mount Diode Package

This surface mount package consists of a circuit mounted on a lead frame and encapsulated within a plastic compound. The compound will withstand soldering temperature with no deformation, and circuit performance characteristics will remain stable when operated in high humidity conditions. Leads require no additional cleaning or processing when used in soldered assembly.

SMB02

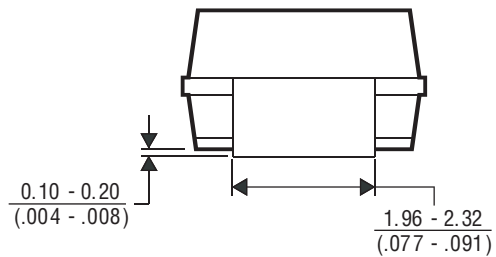
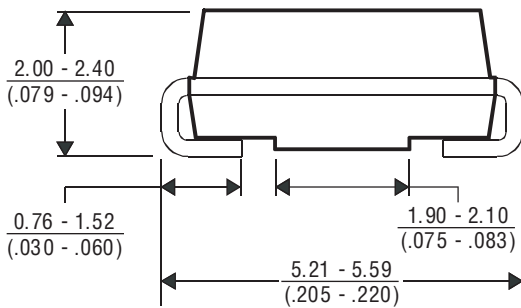
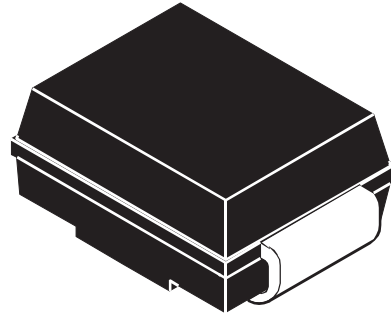
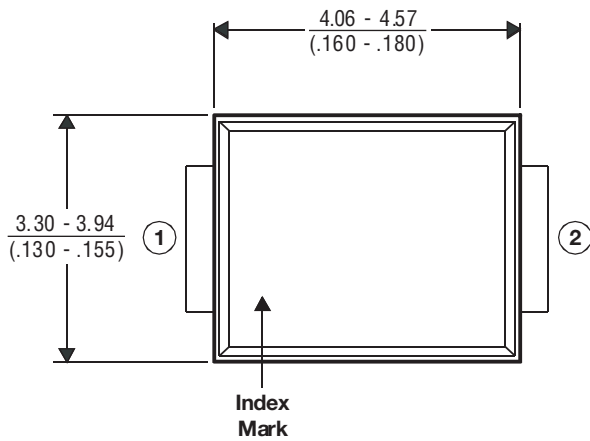

DIMENSIONS ARE: $\frac{\text{MILLIMETERS}}{\text{(INCHES)}}$

MDXXBHG

TISP4xx0T3BJ Overvoltage Protector Series

BOURNS®

MECHANICAL DATA

Tape Dimensions

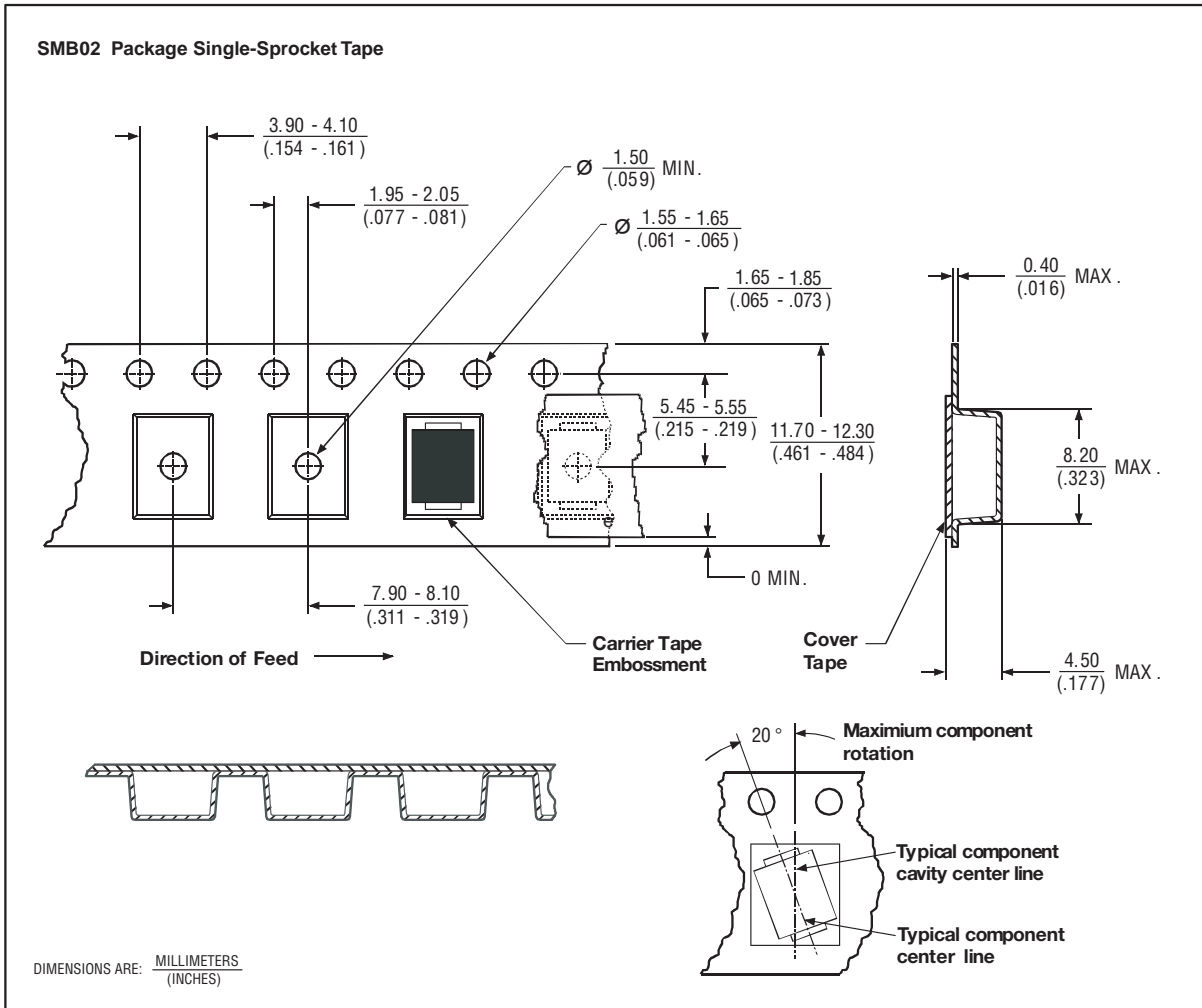

NOTES: A. The clearance between the component and the cavity must be within 0.05 mm (.002 in) MIN. to 0.65 mm (.026 in) MAX. so that the component cannot rotate more than 20° within the determined cavity.

MDXXBH

B. Taped devices are supplied on a reel of the following dimensions:-

Reel diameter: 330 mm \pm 3.0 mm (12.99 in \pm .118 in)
 Reel hub diameter: 75 mm (2.95 in) MIN.
 Reel axial hole: 13.0 mm \pm 0.5 mm (.512 in \pm .020 in)

C. 3000 devices are on a reel.

"TISP" is a trademark of Bourns, Ltd., a Bourns Company, and is Registered in U.S. Patent and Trademark Office.
 "Bourns" is a registered trademark of Bourns, Inc. in the U.S. and other countries.

DECEMBER 2001 - REVISED FEBRUARY 2005

Specifications are subject to change without notice.

Customers should verify actual device performance in their specific applications.