

RoHS Compliant
Pb - Lead Free

Ltr	Revisions	Date	Appr

Electrical Specifications:

Nominal Frequency	12.000	MHz
Temperature Stability	±50	PPM Max
Aging per Year	±3	
Operating Temperature Range (Extended)	-40 to +85	°C
Storage Temperature Range	-55 to +125	
Supply Voltage	3.3 ± 5%	Vdc
Supply Current	7	mA Max
Output Voltage	Logic High (Voh)	90%
	Logic Low (Vol)	10%
Output Symmetry	40 to 60	%
Output Load	15	pF HCMOS
Rise and Fall Time	10	ns Max
Enable-Disable Function	Tri-State	-

Mechanical Specifications:

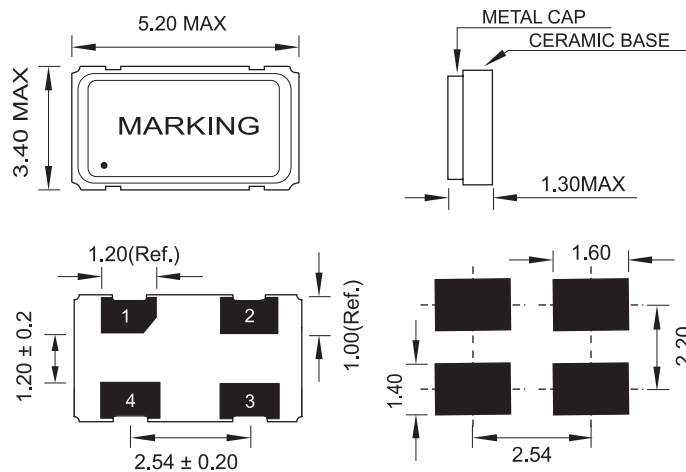

#1 : E/D #2 : GND
#4 : VDC #3 : OUTPUT

Bottom

Recommended Land Pattern



11-3 Chien-Kuo Rd T.E.P.Z. 4027 Taiwan, ROC

All dimensions are millimeters.

CAD: TR

Review: SL

Appr: AL

Page: 1/1 Date: Jan. 16, 2008

Specification Title:

Clock Oscillator

5 x 3.2 mm SMD

Product Specification

Farnell Order Code: 1538893

Part Number: **S53305-12.000-X**