

ROYAL OHM

For P/N 911550

SPECIFICATION FOR APPROVAL

Attn: Sue Green
Technical Dept.



FARNELL ELECTRONIC COMPONENTS.

Description : Chip Resistors

HJW8xxxxTxx RMC 1/8 W (1206) +/- 1% & 5%
 HMWAxxxxTxx RMC 1/10 W (0805) +/- 1% & 5%
 Part no. HPWGxxxxTxx RMC 1/16 W (0603) +/- 1% & 5% ✓

Approved by

Royal Electronic Fty. (Thailand) Co.,Ltd.
 20/1 Moo 2
 Klong-Na, Muang
 Chachoengsao 24000 Tel. 66-38-822404-8
 Thailand Fax. 66-38-512559/823765
 E-mail Address : Export sales : royalexp@sothorn.a-net.net.th
 Local sales : royalloc@sothorn.a-net.net.th
 P.O. Box 251 Klongchan, Bangkok 10240 Thailand

Approved	Checked	Prepared
		

P/N RMC 1/16W (0603) +/- 1% & 5%

Customer : FARNELL

Part No.: HJW8xxxxTxx
 HMWAxxxxTxx
 HPWGxxxxTxx

1. Scope:

This specification for approval relates to Chip Resistors manufactured by ROYAL OHM 's specifications.

2. Type designation:

The type designation shall be in the following form:

Type	Power Rating	Resistance toleranc	Nominal Resistance
RMC 1206	1/8 W	F, J	1KΩ
RMC 0805	1/10 W		
RMC 0603	1/16 W		

3. Ratings:

Type	RMC 1206	RMC 0805	RMC 0603
Power Rating	0.125 W	0.1 W	0.0625 W
Max. Working Voltage	200 V	150 V	50 V
Max. Overload Voltage	400 V	300 V	100 V
Temperature Range	-55°C ~ +125°C		
Ambient Temperature	70 °C		

3.1 Power rating:

Resistors shall have a power rating based on continuous load operation at an ambient temperature of 70 °C . For temperature in excess of 70 °C , The load shall be derate as shown in figure 1.

Figure 1

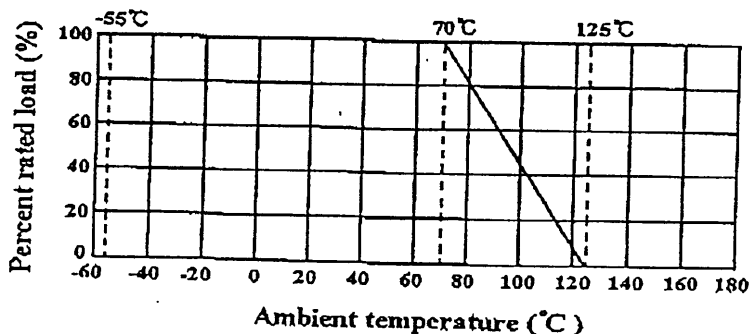

3.2 Nominal Resistance

Effective figures of nominal resistance shall be in accordance with E-24 and E-96 series for 1 % and E-24 series for 2 % and 5 %

P/N RMC 1/16W (0603) +/- 1% + 5%

Chip Resistors

4. Construction :

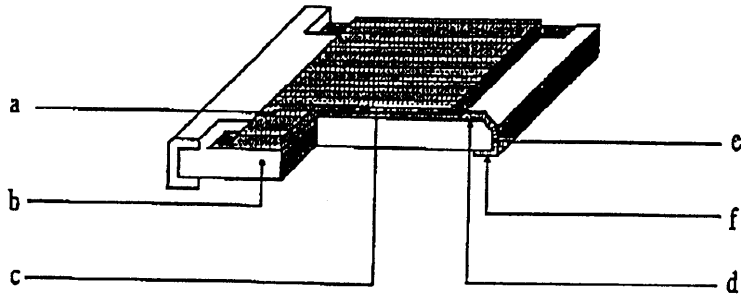

- a. Protective coating : glass
- b. Al₂O₃ high purity alumina substrate : Al 96 %
- c. Resistive element : metal film
- d. Termination (Inner) : Ag/Pd
- e. Termination (Between) : Ni plating film
- f. Termination (Outer) : Sn/Pd plating film

5. Power rating and dimensions

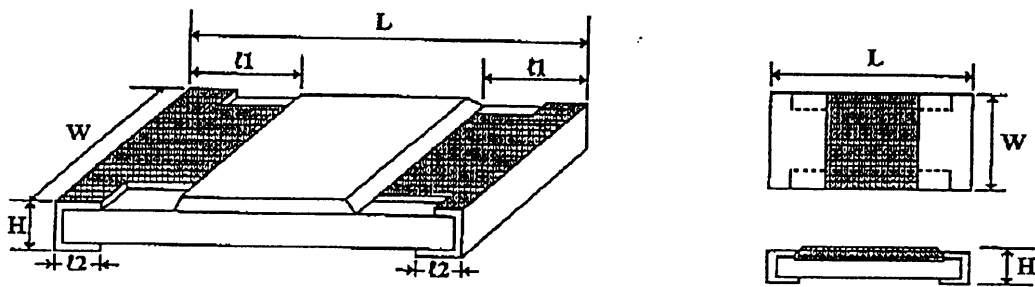

Dimension :

Type	Dimension (mm)				
	L	W + 0.15 - 0.10	H ± 0.10	l ₁ ± 0.20	l ₂ ± 0.20
RMC 1206	3.10 ± 0.15	1.55	0.55	0.45	0.45
RMC 0805	2.00 ± 0.15	1.25	0.55	0.40	0.40
RMC 0603	1.60 ± 0.10	0.80	0.45	0.30	0.30

Power Rating :

Type	Power Rating at 70 °C	Tolerance %	Resistance Range	Standard Series
RMC 1206	0.125 W	± 1 ± 5	10Ω ~ 1MΩ 1Ω ~ 10MΩ	E-96 E-24
RMC 0805	0.1 W			
RMC 0603	0.0625 W			

P/N RMC 1/16W (0603) +/- 1% & 5%

Chip Resistors

6. Marking :

6.1 Resistors

A. ± 5% Tolerance : the first two digits are significant figures of resistance and the third one denoted number of zeros.

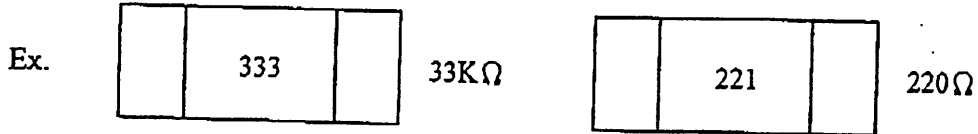

B. For ohmic values below 10 Ω

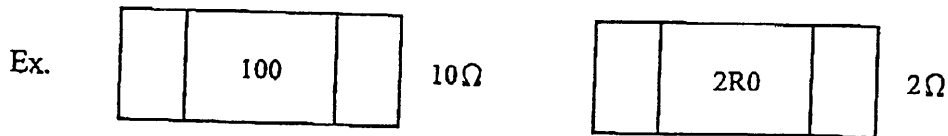

C. ±1% Tolerance : 4 Digits, the first three digits are significant figures of resistance and the fourth digit denoted number of zeros. Letter "R" is for decimal point.

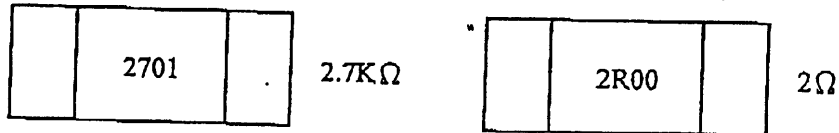

D. For E-96 Series [± 1% (F) Tolerance] in 0603 size 3 digit system (Due to space restrictions) please refer to page 6 for coding formula

6.2 Labels

Label shall be marked with the following item :

- A. Nominal Resistance
- B. Resistance Tolerance
- C. Power Rating
- D. Size
- E. Quantity
- F. Lot Number

ROYAL OHM		
Chip Resistors		
Resistance :	330 E Ω	± 1 %
Wattage :	1/8 W	Size : 1206
Quantity :	5000 Pcs.	
Part No.:		
Lot No. :	825723	

Remark : ± 1 % : Label is 330E, value is 330Ω, marking is 3300

P/N RMC 1/16W (0603) +/- 1% J52

Chip Resistors

7. Performance specification :

Characteristics	Limits	Test Methods (JIS - C - 5202)															
Temperature coefficient	$\pm 5\%$: $1\Omega \sim 10\Omega \leq \pm 400 \text{ PPM}/^\circ\text{C}$ $11\Omega \sim 10\text{M}\Omega \leq \pm 200 \text{ PPM}/^\circ\text{C}$ $\pm 1\%$: $10\Omega \sim 100\Omega \leq \pm 200 \text{ PPM}/^\circ\text{C}$ $101\Omega \sim 1\text{M}\Omega \leq \pm 100 \text{ PPM}/^\circ\text{C}$	5.2 Natural resistance change per temp. degree centigrade. $\frac{R_2 - R_1}{R_1(t_2 - t_1)} \times 10 \text{ (PPM}/^\circ\text{C)}$ R1: Resistance value at room temperature (t1) R2: Resistance value at room temp. plus 100 °C (t2)															
Short time overload	Resistance change rate is $\pm 5\%$ (2.0% + 0.1 Ω) Max. $\pm 1\%$ (1.0% + 0.1 Ω) Max.	5.5 Permanent resistance change after the application of a potential of 2.5 times RCWV for 5 seconds															
Insulation resistance	1,000 M Ω or more	5.6 Apply 500V DC between protective coating and termination for 1 min, then measure															
Dielectric withstanding voltage	No evidence of flashover mechanical damage, arcing or insulation break down	5.7 Apply 500V AC between protective coating and termination for 1 minute															
Terminal bending	$\pm (1.0\% + 0.05 \Omega)$ Max.	6.1.4 Twist of Test Board : Y/X = 5/90 mm for 10 seconds															
Soldering Heat	Resistance change rate is $\pm (1.0\% + 0.05 \Omega)$ Max.	6.4 Dip the resistor into a solder bath having a temperature of $260^\circ\text{C} \pm 5^\circ\text{C}$ and hold it for 10 ± 1 seconds															
Temperature cycling	$\pm 5\%$ (1.0% + 0.05 Ω) Max. $\pm 1\%$ (0.5% + 0.05 Ω) Max.	7.4 Resistance change after continuous 5 cycles for duty cycle specified below :															
		<table border="1"> <thead> <tr> <th>Step</th> <th>Temperature</th> <th>Time</th> </tr> </thead> <tbody> <tr> <td>1</td> <td>$-55^\circ\text{C} \pm 3^\circ\text{C}$</td> <td>30 mins</td> </tr> <tr> <td>2</td> <td>Room temp.</td> <td>10~15 mins</td> </tr> <tr> <td>3</td> <td>$+125^\circ\text{C} \pm 2^\circ\text{C}$</td> <td>30 mins</td> </tr> <tr> <td>4</td> <td>Room temp.</td> <td>10~15 mins</td> </tr> </tbody> </table>	Step	Temperature	Time	1	$-55^\circ\text{C} \pm 3^\circ\text{C}$	30 mins	2	Room temp.	10~15 mins	3	$+125^\circ\text{C} \pm 2^\circ\text{C}$	30 mins	4	Room temp.	10~15 mins
		Step	Temperature	Time													
		1	$-55^\circ\text{C} \pm 3^\circ\text{C}$	30 mins													
		2	Room temp.	10~15 mins													
3	$+125^\circ\text{C} \pm 2^\circ\text{C}$	30 mins															
4	Room temp.	10~15 mins															
Load life in humidity	Resistance change rate is $\pm 5\%$ (3.0% + 0.1 Ω) Max. $\pm 1\%$ (1.0% + 0.1 Ω) Max.	7.9 Resistance change after 1,000 hours (1.5 hours "on", 0.5 hour "off") at RCWV in a humidity chamber controlled at $40^\circ\text{C} \pm 2^\circ\text{C}$ and 90 to 95 % relative humidity															
Load Life	Resistance change rate is $\pm 5\%$ (3.0% + 0.1 Ω) Max. $\pm 1\%$ (1.0% + 0.1 Ω) Max.	7.10 Permanent resistance change after 1,000 hours operating at RCWV, with duty cycle of (1.5 hours "on", 0.5 hour "off") at $70^\circ\text{C} \pm 2^\circ\text{C}$ ambient															
Solderability	95 % coverage Min.	6.5 Test temperature of solder : $235^\circ\text{C} \pm 5^\circ\text{C}$ Dipping them solder : 3 ± 0.5 seconds															

P/N Rmc 1/16W (0603) +/- 1% & 5%

Chip Resistors

8. Packing specification :

* Taping Dimension (mm)

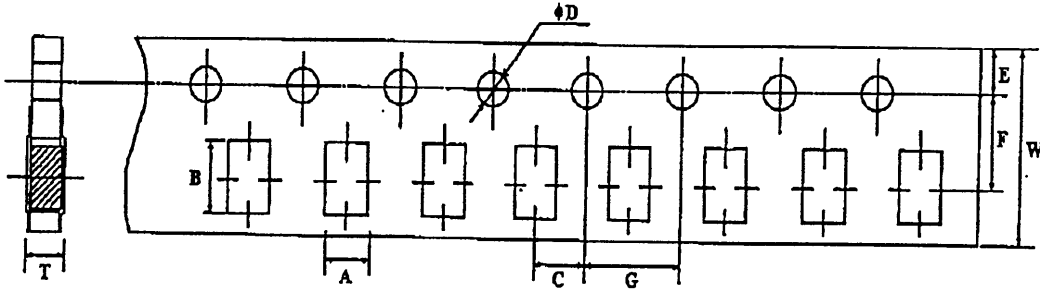

Type	A ±0.2	B ±0.2	C ±0.05	φD+0.1 -0	E ±0.1	F ±0.05	G ±0.1	W ±0.2	T ±0.1
1206	2.00	3.6	2.0	1.5	1.75	3.5	4.0	8	0.81
0805	1.65	2.4	2.0	1.5	1.75	3.5	4.0	8	0.81
0603	1.10	1.9	2.0	1.5	1.75	3.5	4.0	8	0.67

* Reel Dimension (mm)

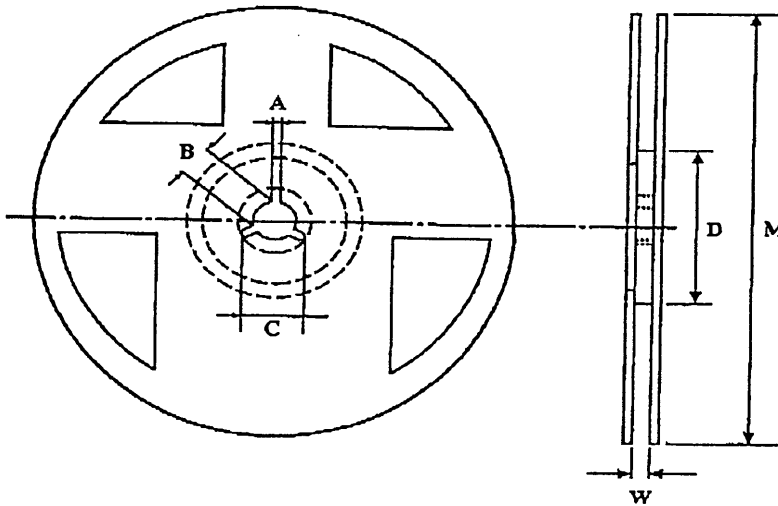

Quantity Per Reel	A ±0.5	B ±0.5	C ±0.5	D ±1	M ±2	W ±1
5000 Pcs. Reel	2	13	21	80	178	10

Remark : φ M 10,000pcs. / Reel = 255 ± 2mm
20,000pcs. / Reel = 330 ± 2mm

P/N RMC 1/16W (0603) +/- 1% & 5%

Chip Resistors

Multiplier Code :

Code	A	B	C	D	E	F	G	H	X	Y	Z
Multiplier	10 ⁰	10 ¹	10 ²	10 ³	10 ⁴	10 ⁵	10 ⁶	10 ⁷	10 ⁻¹	10 ⁻²	10 ⁻³

Coding

Formula

Example : 10.2KΩ - 102 X 10² Ω = 02C

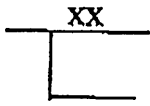

Resistance Code

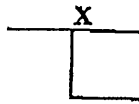

Multiplier Code

33.2Ω = 332 X 10⁻¹ = 51X

Value	Code	Value	Code	Value	Code	Value	Code
100	01	200	30	402	59	806	88
102	02	205	31	412	60	825	89
105	03	210	32	422	61	845	90
107	04	215	33	432	62	866	91
110	05	221	34	442	63	887	92
113	06	226	35	453	64	909	93
115	07	232	36	464	65	931	94
118	08	237	37	475	66	953	95
121	09	243	38	487	67	976	96
124	10	249	39	499	68		
127	11	255	40	511	69		
130	12	261	41	523	70		
133	13	267	42	536	71		
137	14	274	43	549	72		
140	15	280	44	562	73		
143	16	287	45	576	74		
147	17	294	46	590	75		
150	18	301	47	604	76		
154	19	309	48	619	77		
158	20	316	49	634	78		
162	21	324	50	649	79		
165	22	332	51	665	80		
169	23	340	52	681	81		
174	24	348	53	698	82		
178	25	357	54	715	83		
182	26	365	55	732	84		
187	27	374	56	750	85		
191	28	383	57	768	86		
196	29	392	58	787	87		

P/N RMC 1/16W (0603) +/- 1% + 52

Part Number System

Explanation of Part Number System (Chip Resistors)

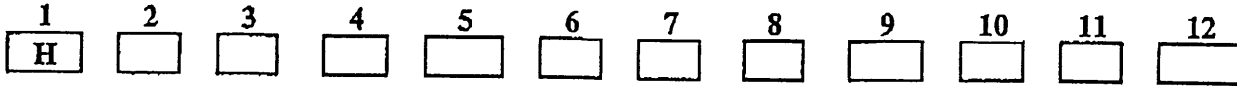

Resistor Type
Chip resistor

Series Code
 A ~ 2512
 D ~ 2010
 G ~ 1210
 J ~ 1206
 M ~ 0805
 P ~ 0603
 S ~ 0402
 4 ~ 4D03

Power Rating
 1W ~ 1W
 75 ~ 3/4W
 W3 ~ 1/3 W
 W4 ~ 1/4 W
 W8 ~ 1/8W
 WA ~ 1/10W
 WG ~ 1/16W

Resistance Tolerance
 B ~ ± 0.1%
 D ~ ± 0.5%
 F ~ ± 1%
 G ~ ± 2%
 J ~ ± 5%

Nominal Resistance Value
 1. E-6, E-12, E-24 series
 a) Normally, for this series, the 6th box is "0"
 b) Boxes 7 & 8 are for the Ohmic Value
 c) Box no.9 is for the multiplier or indication for no. of zeros.
 2. E-96 series
 a) Boxes 6 to 8 are for the Ohmic Value
 b) Box no 9 is for the multiplier or indication for no. of zeros.
 Decimal point is expressed :
 "J" ~ 0.1, "K" ~ 0.01, "L" ~ 0.001
 Ex: 2Ω26 ~ 226K, 226Ω ~ 2260

Packing Type
 T ~ Paper Tape/Reel
 E ~ Plastic Tape/Reel
 B ~ Bulk

Packing Quantity
 5 ~ 5,000 PCS
 A ~ 10,000 PCS.
 B ~ 20,000 PCS.

Special Product
 For chip resistors, there is no special product to be offered, so "0" will be indicated in Box no. 12.

Sample : RMC 1/8W (1206) +/- 0.5% 330 Ω T/R-5000 → HJW8D3300T50
 RMC 1/10W (0805) +/- 0.1% 330 Ω T/R-5000 → HMWAB0330T50
 RMC 1/16W (0603) +/- 1% 330 Ω T/R-5000 → HPWGF3300T50

Chip Resistors

Mutiplier Code :

Code	A	B	C	D	E	F	G	H	X	Y	Z
Multiplier	10 ⁰	10 ¹	10 ²	10 ³	10 ⁴	10 ⁵	10 ⁶	10 ⁷	10 ⁻¹	10 ⁻²	10 ⁻³

Coding

Formula

Example : 10.2KΩ = 102 X 10² Ω = 02C

XX

X

Resistance Code

Multiplier Code

33.2Ω = 332 X 10⁻¹ = 51X

Value	Code	Value	Code	Value	Code	Value	Code
100	01	200	30	402	59	806	88
102	02	205	31	412	60	825	89
105	03	210	32	422	61	845	90
107	04	215	33	432	62	866	91
110	05	221	34	442	63	887	92
113	06	226	35	453	64	909	93
115	07	232	36	464	65	931	94
118	08	237	37	475	66	953	95
121	09	243	38	487	67	976	96
124	10	249	39	499	68		
127	11	255	40	511	69		
130	12	261	41	523	70		
133	13	267	42	536	71		
137	14	274	43	549	72		
140	15	280	44	562	73		
143	16	287	45	576	74		
147	17	294	46	590	75		
150	18	301	47	604	76		
154	19	309	48	619	77		
158	20	316	49	634	78		
162	21	324	50	649	79		
165	22	332	51	665	80		
169	23	340	52	681	81		
174	24	348	53	698	82		
178	25	357	54	715	83		
182	26	365	55	732	84		
187	27	374	56	750	85		
191	28	383	57	768	86		
196	29	392	58	787	87		