



PART NO.

1MS2T1B1M1 Series

REVISIONS

ECN #	REV	DESCRIPTION	DRAWN	DATE	CHECKD	DATE	APPRVD	DATE
-	A	RELEASED	Veena	31/5/05	Shashi	31/5/05	NK	14/6/05

Miniature

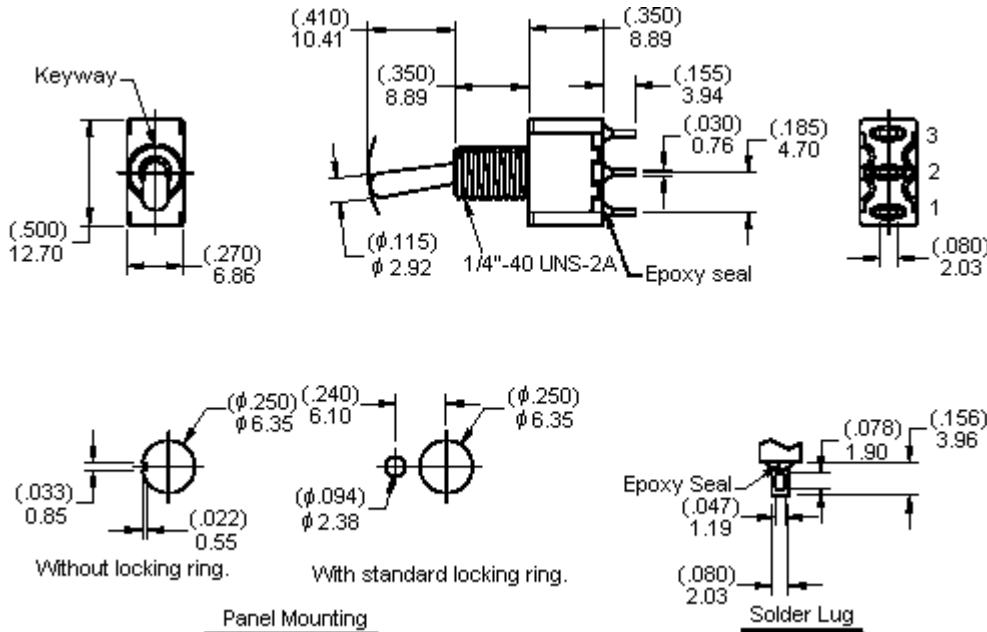

Dimensions : Millimetres (Inches)

Feature:

- Epoxy sealed terminations.

Specifications:

- Electrical Life : 40,000 make-and-break cycles at full load.
- Contact Resistance : 10mΩ maximum initial at 2 - 4V dc
100mA for both silver and gold plated contacts.
- Insulation Resistance : 1000MΩ minimum.
- Dielectric Strength : 1000V RMS at sea level.
- Operating Temperature : -30°C to +85°C.

Materials:

- Case : Dially phthalate (DAP).
- Actuator : Brass, Chrome plated.
- Bushing : Brass, Nickel plated.
- Housing : Stainless Steel.
- Terminal/Contact : Silver or gold plated.

Rating:

- R : 0.4 Volt-Amps (VA) maximum at
20V maximum (AC or DC).
- Q : 2 Amps at 250V ac.
5 Amps at 120V ac or 28V dc.

This data sheet and its contents (the "Information") belong to the Premier Farnell Group (the "Group") or are licensed to it. No licence is granted for the use of it other than for information purposes in connection with the products to which it relates. No licence of any intellectual property rights is granted. The Information is subject to change without notice and replaces all data sheets previously supplied. The Information supplied is believed to be accurate but the Group assumes no responsibility for its accuracy or completeness, any error in or omission from it or for any use made of it. Users of this data sheet should check for themselves the Information and the suitability of the products for their purpose and not make any assumptions based on information included or omitted. Liability for loss or damage resulting from any reliance on the Information or use of it (including liability resulting from negligence or where the Group was aware of the possibility of such loss or damage arising) is excluded. This will not operate to limit or restrict the Group's liability for death or personal injury resulting from its negligence. MULTICOMP is the registered trademark of the Group. © Premier Farnell plc 2004.

TOLERANCES:

UNLESS OTHERWISE SPECIFIED, DIMENSIONS ARE FOR REFERENCE PURPOSES ONLY.

DRAWN BY:	DATE:
Veena	31/05/05
CHECKED BY:	DATE:
Shashi	31/05/05
APPROVED BY:	DATE:
NK	14/06/05

DRAWING TITLE:			
1MS2T1B SPDT Series - Panel Mounting Toggle			
SIZE	DWG NO.	ELECTRONIC FILE	REV
A	M1000000174	39993_DWG	
SCALE: NTS	U.O.M.: mm (Inches)	SHEET: 1 OF 3	



PART NO.

1MS2T1B1M1 Series

REVISIONS

ECN #	REV	DESCRIPTION	DRAWN	DATE	CHECKD	DATE	APPRVD	DATE
-	A	RELEASED	Veena	31/5/05	Shashi	31/5/05	NK	14/6/05

Switch Function

	Position 1	Position 2	Position 3
	<p>ON</p>	<p>OFF</p>	<p>MOM</p>
Terminal Common	2-3		2-1
SCHEMATIC	<p>2 Comm.</p>	OPEN	<p>2 Comm.</p>

Part Number Table

Description	Type	Switch Contacts	Bush Thread	Lever Length	Part Number
Toggle	SPDT on-off-mom	Silver	1/4" x 40 NS	10.4	1MS2T1B1M1QE
		Gold			1MS2T1B1M1RE

Dimensions : Millimetres

This data sheet and its contents (the "Information") belong to the Premier Farnell Group (the "Group") or are licensed to it. No licence is granted for the use of it other than for information purposes in connection with the products to which it relates. No licence of any intellectual property rights is granted. The Information is subject to change without notice and replaces all data sheets previously supplied. The Information supplied is believed to be accurate but the Group assumes no responsibility for its accuracy or completeness, any error in or omission from it or for any use made of it. Users of this data sheet should check for themselves the Information and the suitability of the products for their purpose and not make any assumptions based on information included or omitted. Liability for loss or damage resulting from any reliance on the Information or use of it (including liability resulting from negligence or where the Group was aware of the possibility of such loss or damage arising) is excluded. This will not operate to limit or restrict the Group's liability for death or personal injury resulting from its negligence. MULTICOMP is the registered trademark of the Group. © Premier Farnell plc 2004.

TOLERANCES:
UNLESS OTHERWISE SPECIFIED, DIMENSIONS ARE FOR REFERENCE PURPOSES ONLY.

DRAWN BY:	DATE:
Veena	31/05/05
CHECKED BY:	DATE:
Shashi	31/05/05
APPROVED BY:	DATE:
NK	14/06/05

DRAWING TITLE:			
1MS2T1B SPDT Series - Panel Mounting Toggle			
SIZE	DWG NO.	ELECTRONIC FILE	REV
A	M1000000174	39993_DWG	
SCALE: NTS		U.O.M.: mm (Inches)	SHEET: 2 OF 3



PART NO.

1MS2T1B1M1 Series

REVISIONS

ECN #	REV	DESCRIPTION	DRAWN	DATE	CHECKD	DATE	APPRVD	DATE
-	A	RELEASED	Veena	31/5/05	Shashi	31/5/05	NK	14/6/05

Notes:

International Sales Offices:

- AUSTRALIA - Farnell InOne**
Tel No: ++ 61 2 9645 8888
Fax No: ++ 61 2 9644 7898
- AUSTRIA - Farnell InOne**
Tel No: ++ 43 662 2180 680
Fax No: ++ 43 662 2180 670
- BELGIUM - Farnell InOne**
Tel No: ++ 32 3 475 2810
Fax No: ++ 32 3 227 3648
- BRAZIL - Farnell-Newark InOne**
Tel No: ++ 55 11 4066 9400
Fax No: ++ 55 11 4066 9410
- CHINA - Farnell-Newark InOne**
Tel No: ++86 10 6238 5152
Fax No: ++86 10 6238 5022
- DENMARK - Farnell InOne**
Tel No: ++ 45 44 53 66 44
Fax No: ++ 45 44 53 66 06
- ESTONIA - Farnell InOne**
Tel No: ++ 358 9 560 7780
Fax No: ++ 358 9 345 5411
- FINLAND - Farnell InOne**
Tel No: ++ 358 9 560 7780
Fax No: ++ 358 9 345 5411
- FRANCE - Farnell InOne**
Tel No: ++ 33 474 68 99 99
Fax No: ++ 33 474 68 99 90
- GERMANY - Farnell InOne**
Tel No: ++ 49 89 61 39 39 39
Fax No: ++ 49 89 613 59 01
- HONG KONG - Farnell-Newark InOne**
Tel No: ++ 852 2268 9888
Fax No: ++ 852 2268 9899
- IRELAND - Farnell InOne**
Tel No: ++ 353 1 830 9277
Fax No: ++ 353 1 830 9016
- ITALY - Farnell InOne**
Tel No: ++ 39 02 93 995 200
Fax No: ++ 39 02 93 995 300
- MALAYSIA - Farnell-Newark InOne**
Tel No: ++ 60 3 7873 8000
Fax No: ++ 60 3 7873 7000
- NETHERLANDS - Farnell InOne**
Tel No: ++ 31 30 241 7373
Fax No: ++ 31 30 241 7333
- NORWAY - Farnell InOne**
Tel No: ++ 45 44 53 66 66
Fax No: ++ 45 44 53 66 02
- PORTUGAL - Farnell InOne**
Tel No: ++ 34 93 475 8804
Fax No: ++ 34 93 474 5288
- SINGAPORE - Farnell-Newark InOne**
Tel No: ++ 65 6788 0200
Fax No: ++ 65 6788 0300
- SPAIN - Farnell InOne**
Tel No: ++ 34 93 475 8805
Fax No: ++ 34 93 474 5107
- SWEDEN - Farnell InOne**
Tel No: ++ 46 8 730 50 00
Fax No: ++ 46 8 83 52 62
- SWITZERLAND - Farnell InOne**
Tel No: ++ 41 1 204 64 64
Fax No: ++ 41 1 204 64 54
- UK - Farnell InOne**
Tel No: ++ 44 8701 200 200
Fax No: ++ 44 8701 200 201
- UK - BuckHickman InOne**
Tel No: ++ 44 8450 510 150
Fax No: ++ 44 8450 510 130
- UK - CPC**
Tel No: ++ 44 8701 202 530
Fax No: ++ 44 8701 202 531

export EXPORT - Farnell InOne
Tel No: ++ 44 8701 200 208
Fax No: ++ 44 8701 200 209
For enquiries from all other markets

- <http://www.farnellinone.com>
- <http://www.buckhickmaninone.com>
- <http://www.cpc.co.uk>

This data sheet and its contents (the "Information") belong to the Premier Farnell Group (the "Group") or are licensed to it. No licence is granted for the use of it other than for information purposes in connection with the products to which it relates. No licence of any intellectual property rights is granted. The Information is subject to change without notice and replaces all data sheets previously supplied. The Information supplied is believed to be accurate but the Group assumes no responsibility for its accuracy or completeness, any error in or omission from it or for any use made of it. Users of this data sheet should check for themselves the Information and the suitability of the products for their purpose and not make any assumptions based on information included or omitted. Liability for loss or damage resulting from any reliance on the Information or use of it (including liability resulting from negligence or where the Group was aware of the possibility of such loss or damage arising) is excluded. This will not operate to limit or restrict the Group's liability for death or personal injury resulting from its negligence. MULTICOMP is the registered trademark of the Group. © Premier Farnell plc 2004.

TOLERANCES:
UNLESS OTHERWISE SPECIFIED, DIMENSIONS ARE FOR REFERENCE PURPOSES ONLY.

DRAWN BY:	DATE:
Veena	31/05/05
CHECKED BY:	DATE:
Shashi	31/05/05
APPROVED BY:	DATE:
NK	14/06/05

DRAWING TITLE:			
1MS2T1B SPDT Series - Panel Mounting Toggle			
SIZE	DWG NO.	ELECTRONIC FILE	REV
A	M1000000174	39993_DWG	
SCALE: NTS		U.O.M.: mm (Inches)	SHEET: 3 OF 3