

Specification for BTHQ 128064AVD-FSTF-06-LED02white-COG

Version July 2003

DOCUMENT REVISION HISTORY 1:

DOCUMENT REVISION FROM TO	DATE	DESCRIPTION	CHANGED BY	CHECKED BY
A	2003.07.03	First Release.	SUNNY LEE	DENG YU YUAN

CONTENTS

	<u>Page No.</u>
1. GENERAL DESCRIPTION	4
2. MECHANICAL SPECIFICATIONS	4
3. INTERFACE SIGNALS	9
4. ABSOLUTE MAXIMUM RATINGS	11
4.1 ELECTRICAL MAXIMUM RATINGS (Ta=25°C)	11
4.2 ENVIRONMENTAL CONDITION	11
5. ELECTRICAL SPECIFICATIONS	12
5.1 TYPICAL ELECTRICAL CHARACTERISTICS	12
5.2 TIMING SPECIFICATIONS	13
6. COMMAND TABLE	16
7. APPENDIX – LED SPECIFICATIONS	17

**Specification
of
LCD Module Type
Model No.: COG-BTD12864-04**

1. General Description

- ≠ 128 x 64 Dots FSTN Positive Black & White Transflective Dot Matrix LCD Module.
- ≠ Viewing Angle: 12 o'clock direction.
- ≠ Driving duty: 1/65 Duty, 1/7 bias.
- ≠ 'Epson' S1D10605D04B (COG) Dot Matrix LCD Driver or equivalent.
- ≠ FPC
- ≠ White LED02 backlight.

2. Mechanical Specifications

The mechanical detail is shown in Fig. 2 and summarized in Table 1 below.

Table 1

Parameter	Specifications	Unit
Outline dimensions	55.6(W) x 70.2(H) x 4.42(D) (Included FPC. Excluded pins)	mm
Viewing area	50.60(W) x 31.0(H)	mm
Active area	46.577(W) x 27.697(H)	mm
Display format	128(W) x 64(H)	dots
Dot size	0.349(W) x 0.418(H)	mm
Dot spacing	0.015(W) x 0.015(H)	mm
Dot pitch	0.364(W) x 0.433(H)	mm
Weight	Approx. 14.0	grams

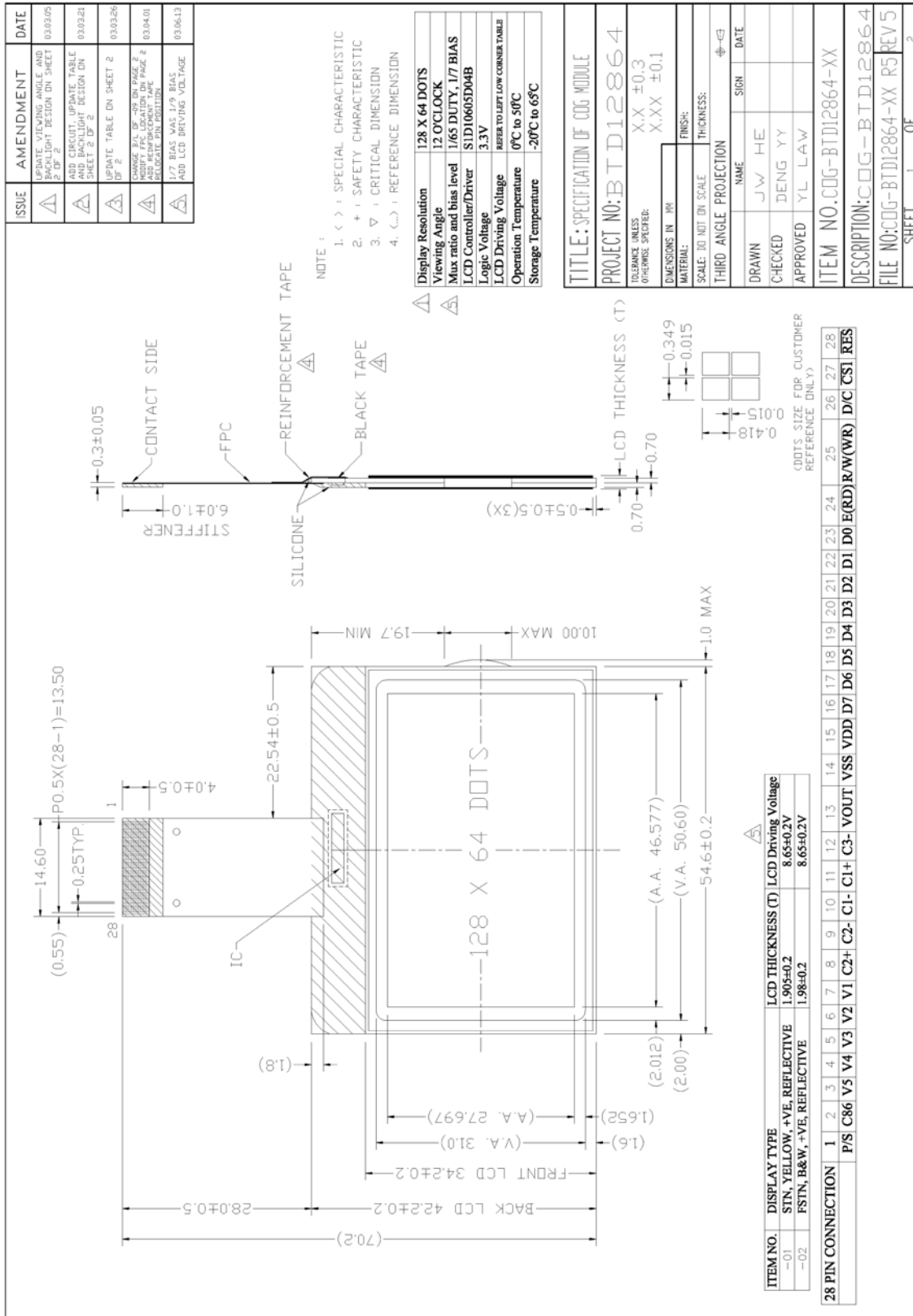

Figure 1: Outline Drawing 1

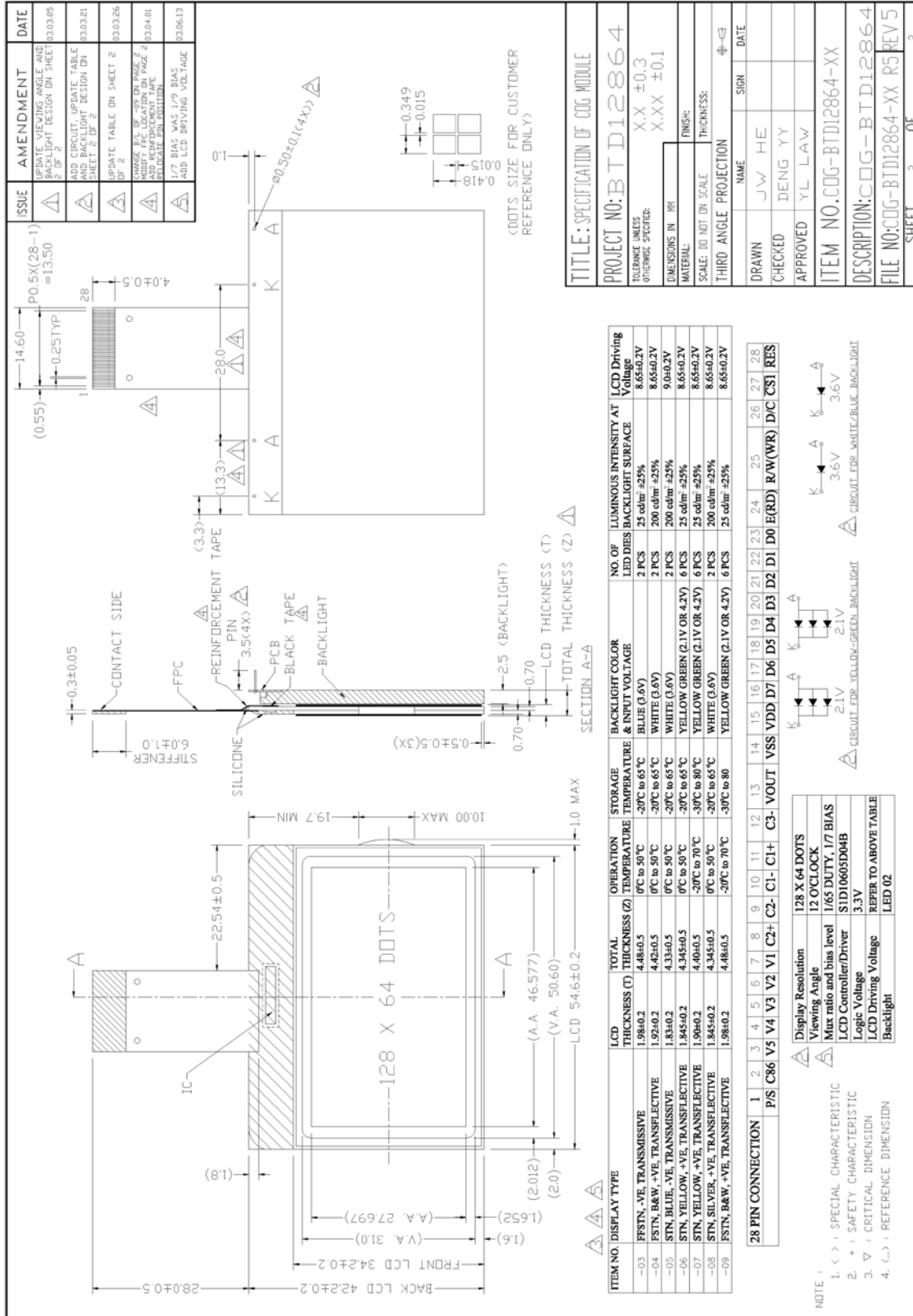

Figure 2: Outline Drawing 2

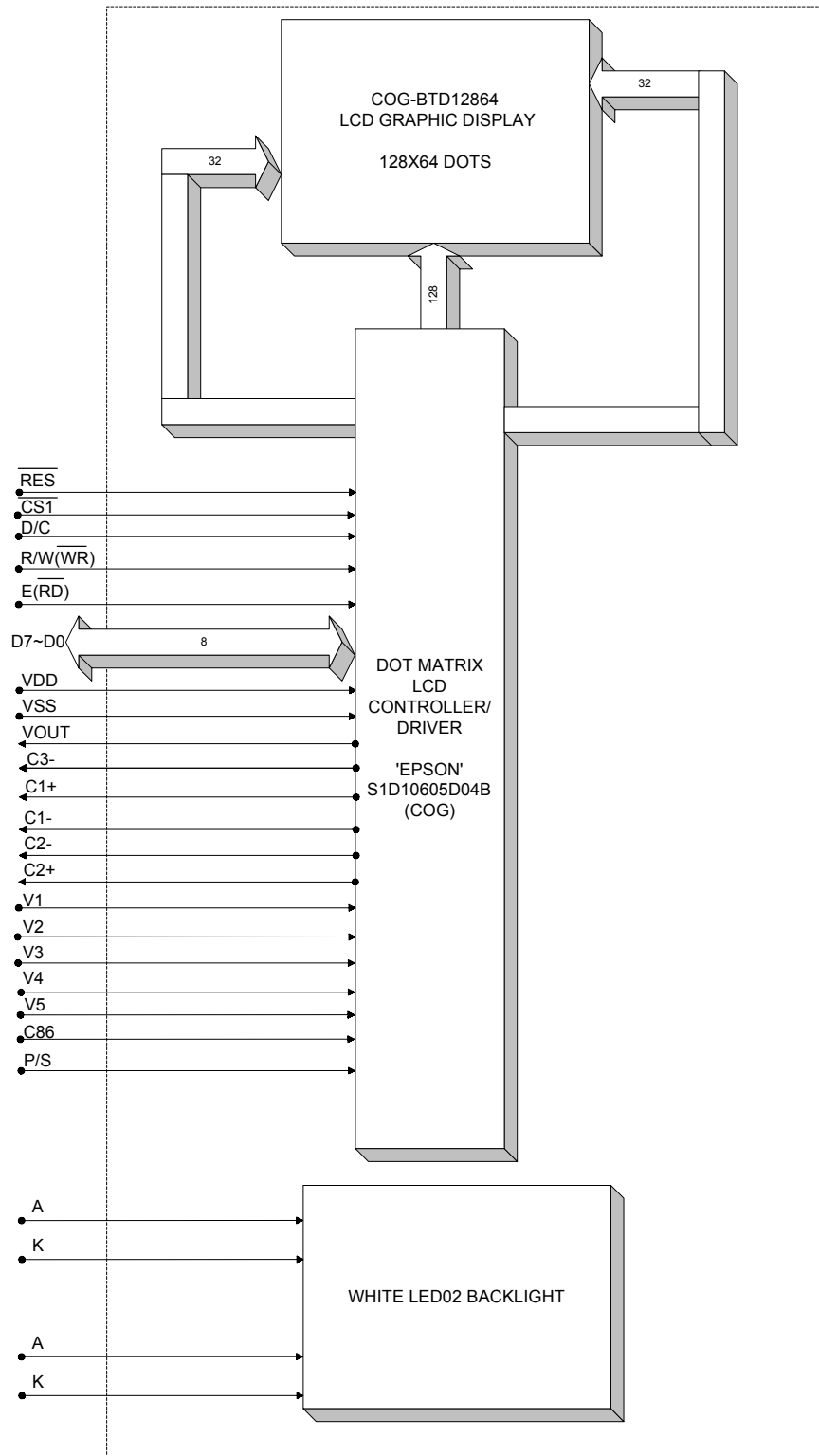

Figure 3: Block Diagram.

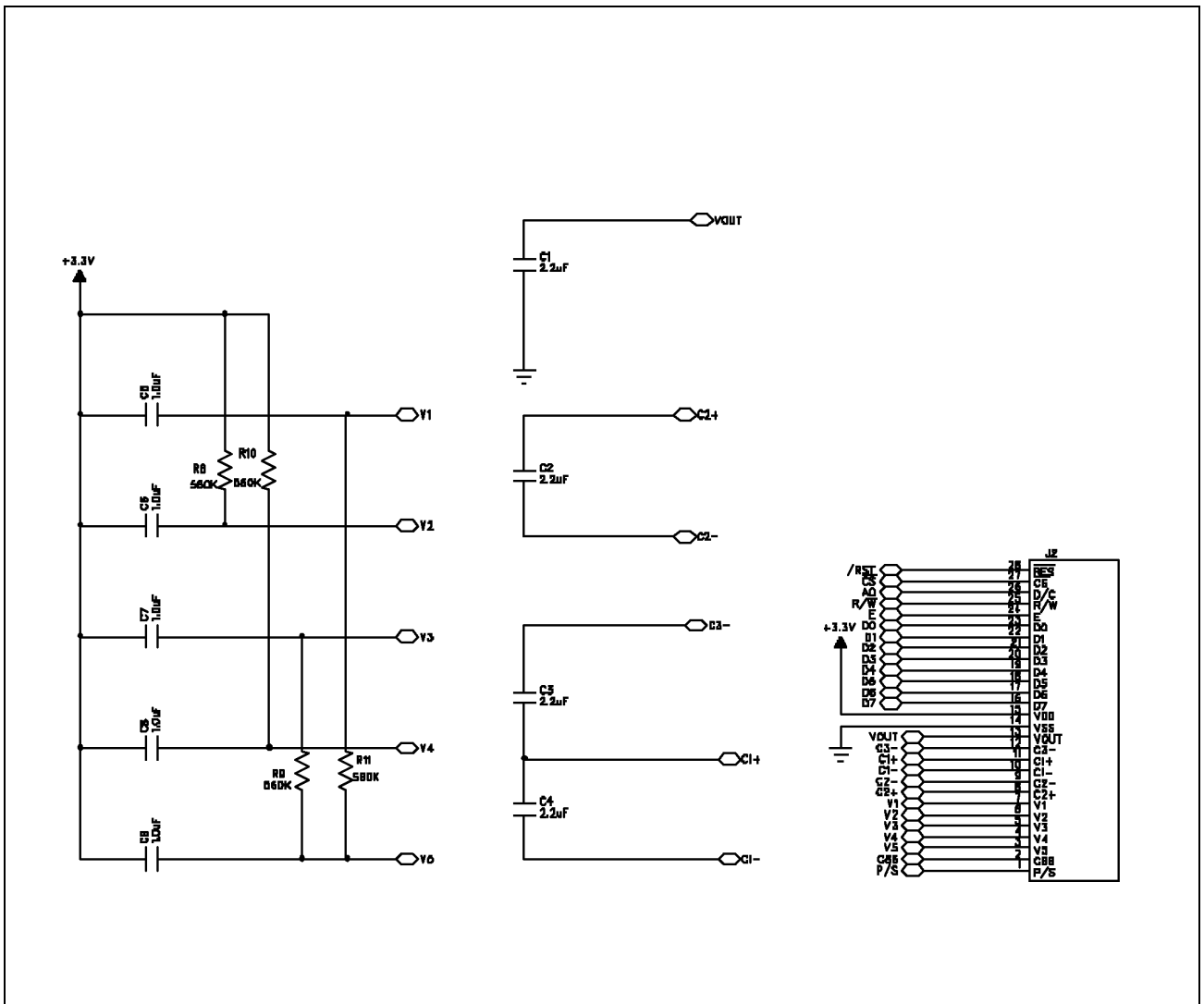

Figure 4: Reference Circuit

3. Interface signals

Table 2(a): Pin Assignment

Pin No.	Symbol	Description															
1	P/S	<p>This is the parallel data input/serial data input switch terminal. P/S = HIGH: Parallel data input. P/S = LOW: Serial data input.</p> <p>The following applies depending on the P/S status:</p> <table border="1"> <thead> <tr> <th>P/S</th> <th>Data/Command</th> <th>Data</th> <th>Read/Write</th> <th>Serial Clock</th> </tr> </thead> <tbody> <tr> <td>HIGH</td> <td>D/C(A0)</td> <td>D0 to D7</td> <td>\overline{RD}, WR</td> <td></td> </tr> <tr> <td>LOW</td> <td>D/C(A0)</td> <td>SI (D7)</td> <td>Write only</td> <td>SCL (D6)</td> </tr> </tbody> </table> <p>When P/S = LOW, D0 to D5 are HZ. D0 to D5 may be HIGH, LOW or Open. $\overline{RD}(E)$ and $\overline{WR}(R/\overline{W})$ are fixed to either HIGH or LOW. With serial data input, RAM display data reading is not supported.</p>	P/S	Data/Command	Data	Read/Write	Serial Clock	HIGH	D/C(A0)	D0 to D7	\overline{RD} , WR		LOW	D/C(A0)	SI (D7)	Write only	SCL (D6)
P/S	Data/Command	Data	Read/Write	Serial Clock													
HIGH	D/C(A0)	D0 to D7	\overline{RD} , WR														
LOW	D/C(A0)	SI (D7)	Write only	SCL (D6)													
2	C86	<p>This is the MPU interface switch terminal. C86=HIGH: 6800 Series MPU interface. C86=LOW: 8080 MPU interface.</p>															
3	V5	<p>This is multi-level power supply for liquid crystal drive. Voltage levels are determined based on VDD, and must maintain the relative magnitudes shown below. $VDD (=V0) \geq V1 \geq V2 \geq V3 \geq V4 \geq V5$</p> <p>Master operation When the power supply turns ON, the internal power supply circuits produce V1 to V4 voltages shown below. The voltage setting are selected using the LCD bias set command.</p> <p>For 1/7 bias: $V1=(1/7) \times V5$, $V2=(2/7) \times V5$, $V3=(5/7) \times V5$, $V4=(6/7) \times V5$.</p>															
4	V4																
5	V3																
6	V2																
7	V1																
8	C2+	DC/DC voltage converter. Connects a capacitor between this terminal and C2- terminal.															
9	C2-	DC/DC voltage converter. Connects a capacitor between this terminal and C2+ terminal.															
10	C1-	DC/DC voltage converter. Connects a capacitor between this terminal and C1+ terminal.															
11	C1+	DC/DC voltage converter. Connects a capacitor between this terminal and C1- terminal.															
12	C3-	DC/DC voltage converter. Connects a capacitor between this terminal and C1+ terminal.															
13	VOUT	DC/DC voltage converter. Connects a capacitor between this terminal and VSS.															
14	VSS	0 V pin connected to the system ground (GND) and this is also the reference power supply for the step-up voltage circuit for the liquid crystal drive.															
15	VDD	Power supply for logic(+3.3V).															

Table 2(b): Pin Assignment

Pin No.	Symbol	Description
16	D7	This is an 8-bit bi-directional data bus that connects to an 8-bit standard MPU data bus. When the serial interface is selected (P/S = LOW), then D7 serves as the serial data input terminal (SI) and D6 serves as the serial clock input terminal (SCL). At this time, D0 to D5 are set to high impedance. When the chip select is inactive, D0 to D7 are set to high impedance.
17	D6	
18	D5	
19	D4	
20	D3	
21	D2	
22	D1	
23	D0	
24	$\overline{E(RD)}$	When connected to an 8080 MPU, this is active LOW. This pin is connected to the \overline{RD} signal of the 8080 MPU, and the S1D15605 series data bus is in an output status when this signal is LOW. When connected to a 6800 Series MPU, this is active HIGH. This is the 6800 Series MPU enable clock input terminal.
25	$R/W(\overline{WR})$	When connected to an 8080 MPU, this is active LOW. This terminal connects to the 8080 MPU \overline{WR} signal. The signals on the data bus are latched at the rising edge of the \overline{WR} signal. When connected to an 6800 Series MPU: This is the read/write control signal input terminal. When R/\overline{W} = HIGH: Read. When R/\overline{W} = LOW: Write.
26	D/C	This is connect to the least significant bit of the normal MPU address bus, and it determines whether the data bits are data or a command. D/C(A0)="High": Indicates that D0 to D7 are display data. D/C(A0)="Low": Indicates that D0 to D7 are control data.
27	$\overline{CS1}$	This is the chip select signal for first chip. When $\overline{CS1}$ =LOW and $\overline{CS2}$ =HIGH, then the chip select becomes active and the data/commands I/O is enabled.
28	\overline{RES}	When \overline{RES} is set to LOW, the settings are initialized. The reset operation is performed by the \overline{RES} signal level.
-	A	Anode of backlight.
-	K	Cathode of backlight.

4. Absolute Maximum Ratings

4.1 Electrical Maximum Ratings (Ta = 25 °C)

Table 3

Parameter	Symbol	Min.	Max.	Unit
Power Supply voltage (Logic)	VDD-VSS	-0.3	+6.0	V
Power Supply voltage(VSS2)(VDD standard)	VSS2	-4.0	+0.3	V
Power Supply voltage(V5,VOUT)(VDD standard)	V5,VOUT	-18.0	+0.3	V
Power Supply voltage(V1,V2,V3,V4)(VDD standard)	V1,V2,V3,V4	V5	+0.3	V
Input voltage	Vin	-0.3	VDD+0.3	V

Note: 1.)The VSS2, V1 to V5 and VOUT are relative to the VDD=0V reference.

2.)The V1, V2, V3, and V4 voltages must always satisfy the condition of $VDD \geq V1 \geq V2 \geq V3 \geq V4 \geq V5$.

3.)The modules may be destroyed if they are used beyond the absolute maximum ratings.

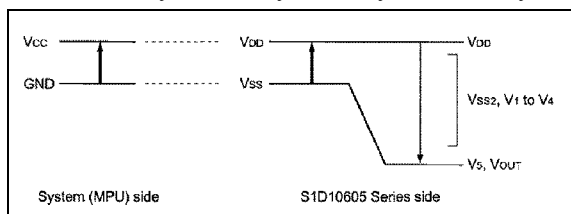

4.2 Environmental Condition

Table 4

Item	Operating Temperature (Topr)		Storage Temperature (Tstg)		Remark
	Min.	Max.	Min.	Max.	
Ambient Temperature	0°C	+50°C	-20°C	+65°C	Dry
Humidity	95% max. RH for Ta ≤ 40°C < 95% RH for Ta > 40°C				no condensation
Vibration (IEC 68-2-6) cells must be mounted on a suitable connector	Frequency: 10 ~ 55 Hz Amplitude: 0.75 mm Duration: 20 cycles in each direction.				3 directions
Shock (IEC 68-2-27) Half-sine pulse shape	Pulse duration : 11 ms Peak acceleration: 981 m/s ² = 100g Number of shocks : 3 shocks in 3 mutually perpendicular axes.				3 directions

5. Electrical Specifications

5.1 Typical Electrical Characteristics

At $T_a = +25\text{ }^\circ\text{C}$, $V_{DD} = +3.3\pm 5\%$, $V_{SS} = 0\text{V}$.

Table 5

Parameter	Symbol	Conditions	Min.	Typ.	Max.	Unit
Supply voltage (Logic)	VDD-VSS		3.14	3.3	3.47	V
Supply voltage (LCD) (built-in)	VLCD =VDD-V5	Ta = 0 °C, Character mode VDD = +3.3V, Note 1	-	8.80	-	V
		Ta = 25 °C, Character mode VDD = +3.3V, Note 1	8.45	8.65	8.85	V
		Ta = 50 °C, Character mode VDD = +3.3V, Note 1	-	7.95	-	V
Low-level input signal voltage	V _{ILC}	Note 2	VSS	-	0.2xVDD	V
High-level input signal voltage	V _{IHC}	Note 2	0.8xVDD	-	VDD	V
Supply Current (Logic & LCD)	IDD	VDD = +3.3V,Note 1, Character mode	-	0.3	0.45	mA
		VDD = +3.3V,Note 1, Checker board mode	-	0.5	0.75	mA
Supply voltage of white LED02 backlight	VLED =VAK	Forward current =2x15=30 mA Number of LED dies=2	3.2	3.6	4.0	V
Luminous intensity at backlight surface		Forward current =2x15=30 mA Number of LED dies=2	150	200	250	cd/m ²

Note 1: There is tolerance in optimum LCD driving voltage during production and it will be within the specified range.

Note 2: A0, D0 to D5,D6(SCL),D7(SI),E(RD),R/W(WR),CS1,C86,P/S,RES terminals.

5.2 Timing Specifications

System Bus read/Write Characteristics 1 (For the 8080 Series MPU)

At $T_a = 0\text{ }^{\circ}\text{C}$ to $+50\text{ }^{\circ}\text{C}$, $V_{DD} = +3.3\text{V} \pm 5\%$, $V_{SS} = 0\text{V}$.

Table 6

Item	Signal	Symbol	Condition	Rating		Units
				Min.	Max.	
Address hold time	A0	t _{AH8}		0	—	ns
Address setup time	A0	t _{AW8}		0	—	ns
System cycle time 1	A0	t _{CYCL8}		300	—	ns
System cycle time 2	A0	t _{CYCH8}		300	—	ns
Control LOW pulse width (Write)	$\overline{\text{WR}}$	t _{CCLW}		60	—	ns
Control LOW pulse width (Read)	$\overline{\text{RD}}$	t _{CCLR}		120	—	ns
Control HIGH pulse width (Write)	$\overline{\text{WR}}$	t _{CCHW}		60	—	ns
Control HIGH pulse width (Read)	$\overline{\text{RD}}$	t _{CCHR}		60	—	ns
Data setup time	D0 to D7	t _{DS8}		40	—	ns
Data hold time		t _{DH8}		15	—	ns
$\overline{\text{RD}}$ access time		t _{ACC8}	CL = 100 pF	—	140	ns
Output disable time		t _{OH8}		10	100	ns

*1 The input signal rise time and fall time (t_r , t_f) is specified at 15 ns or less. When the system cycle time is extremely fast, $(t_r + t_f) \leq (t_{CYCL(H)8} - t_{CCLW} - t_{CCHW})$ for $(t_r + t_f) \leq (t_{CYCL(H)8} - t_{CCLR} - t_{CCHR})$ are specified.

*2 All timing is specified using 20% and 80% of V_{DD} as reference.

*3 t_{CCLW} and t_{CCLR} are specified as the overlap between $\overline{\text{CS1}}$ being LOW ($\text{CS2}=\text{HIGH}$) and $\overline{\text{WR}}$ and $\overline{\text{RD}}$ being at the LOW level.

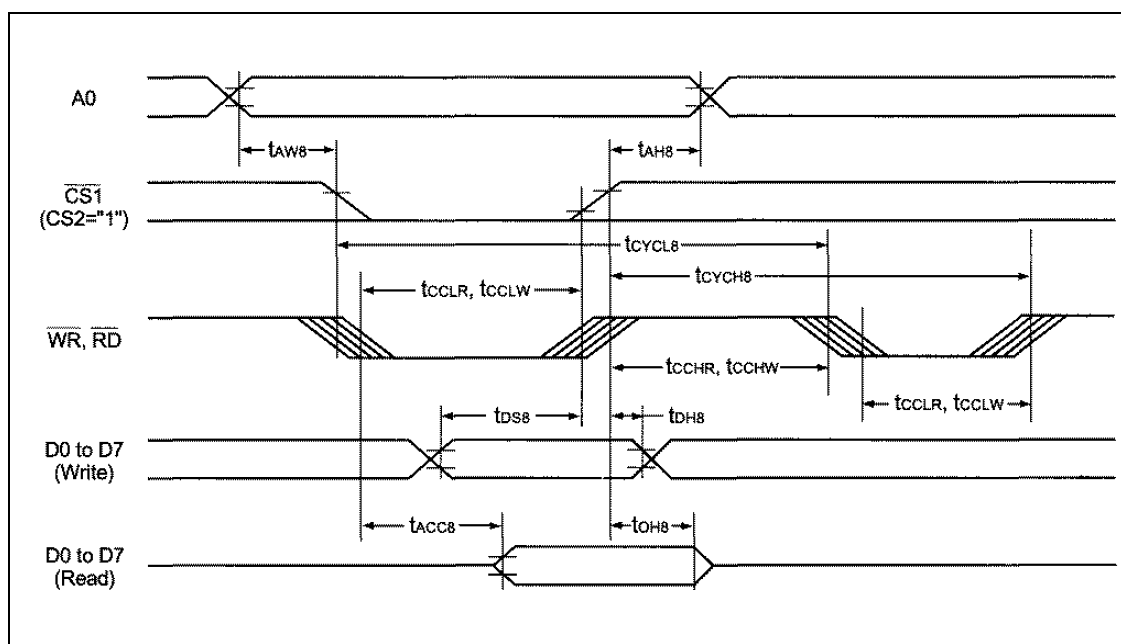

Figure 5: The timing diagram of system bus read/write (For the 8080 Series MPU)

System Bus read/Write Characteristics 2 (For the 6800 Series MPU)

At $T_a = 0\text{ }^{\circ}\text{C}$ to $+50\text{ }^{\circ}\text{C}$, $V_{DD} = +3.3\text{V} \pm 5\%$, $V_{SS} = 0\text{V}$.

Table 7

Item	Signal	Symbol	Condition	Rating		Units
				Min.	Max.	
Address hold time	A0	t _{AH6}		0	—	ns
Address setup time	A0	t _{AW6}		0	—	ns
System cycle time 1	A0	t _{CYCH6}		300	—	ns
System cycle time 2		t _{CYCL6}		300	—	ns
Data setup time	D0 to D7	t _{DS6}		40	—	ns
Data hold time		t _{DH6}		15	—	ns
Access time		t _{ACC6}	CL = 100 pF	—	140	ns
Output disable time		t _{OH6}		10	100	ns
Enable HIGH pulse time	Read	E	t _{EWHR} t _{EWHW}	120	—	ns
	Write			60	—	ns
Enable LOW pulse time	Read	E	t _{EWLR} t _{EWLW}	60	—	ns
	Write			60	—	ns

*1 The input signal rise time and fall time (t_r , t_f) is specified at 15 ns or less. When the system cycle time is extremely fast, $(t_r + t_f) \leq (t_{CYCH(L)6} - t_{EWLR} - t_{EWHW})$ for $(t_r + t_f) \leq (t_{CYCH(L)6} - t_{EWLR} - t_{EWHR})$ are specified.

*2 All timing is specified using 20% and 80% for V_{DD} as the reference.

*3 t_{EWLW} and t_{EWLR} are specified as the overlap between $\overline{CS1}$ being LOW (CS2=HIGH) and E.

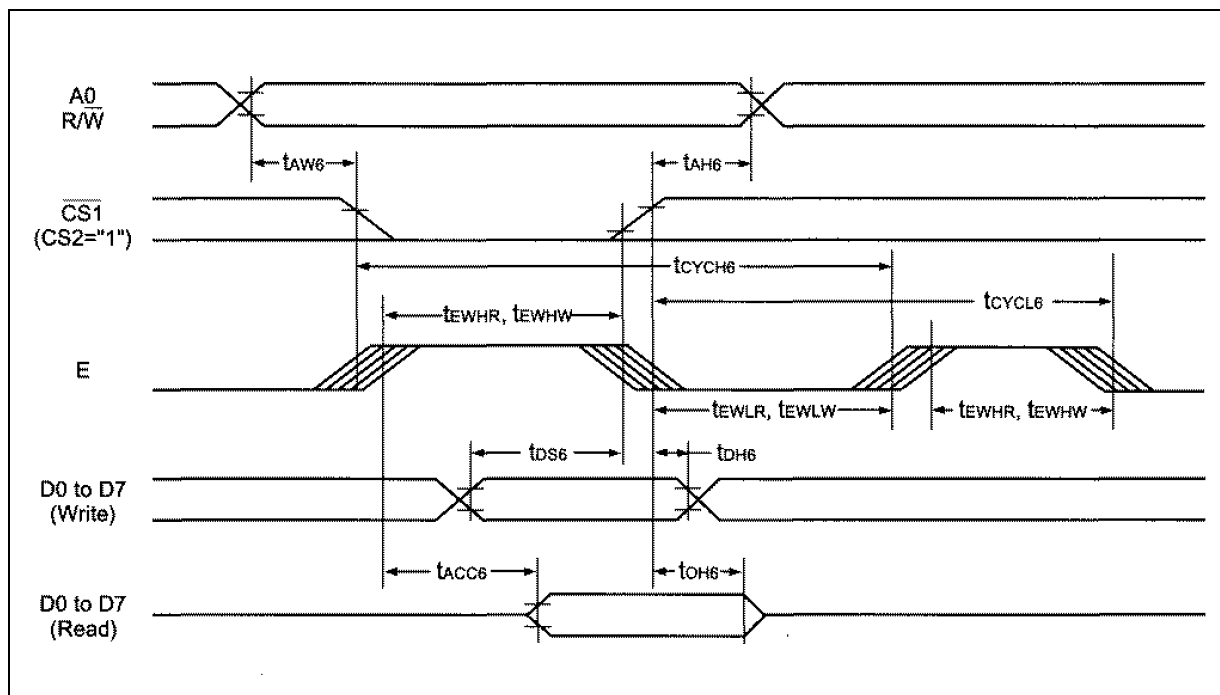

Figure 6: The timing diagram of system bus read/write (For the 6800 Series MPU)

The serial interface

At $T_a = 0\text{ }^{\circ}\text{C}$ to $+50\text{ }^{\circ}\text{C}$, $V_{DD} = +3.3\text{V} \pm 5\%$, $V_{SS} = 0\text{V}$.

Table 8

Item	Signal	Symbol	Condition	Rating		Units
				Min.	Max.	
Serial Clock Period	SCL	t _{SCYC}		250	—	ns
SCL HIGH pulse width		t _{SHW}		100	—	ns
SCL LOW pulse width		t _{SLW}		100	—	ns
Address setup time	A0	t _{SAS}		150	—	ns
Address hold time		t _{SAH}		150	—	ns
Data setup time	SI	t _{SDS}		100	—	ns
Data hold time		t _{SDH}		100	—	ns
CS-SCL time	CS	t _{CSS}		150	—	ns
		t _{CSH}		150	—	ns

Note 1: The input signal rise and fall (t_r , t_f) are specified at 15ns or less.

Note 2: All timing is specified using 20% and 80% of V_{DD} as the standard.

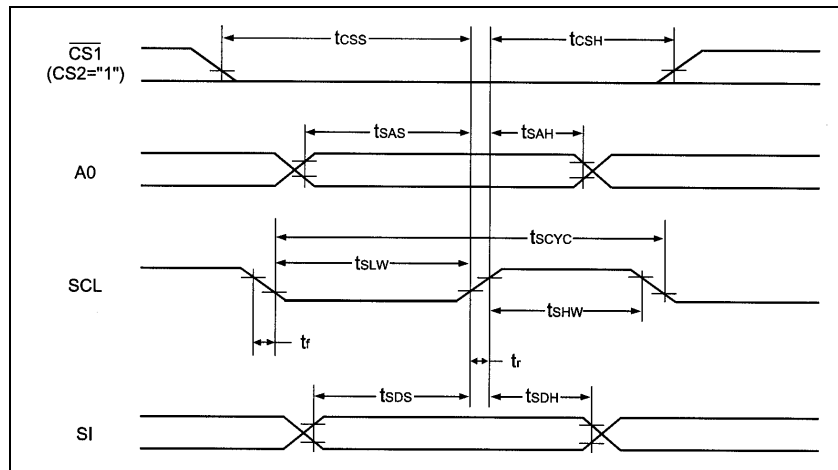

Figure 7: The timing diagram of serial interface

Reset Timing

At $T_a = 0\text{ }^{\circ}\text{C}$ to $+50\text{ }^{\circ}\text{C}$, $V_{DD} = +3.3\text{V} \pm 5\%$, $V_{SS} = 0\text{V}$.

Table 9

Item	Signal	Symbol	Condition	Rating			Units
				Min.	Typ.	Max.	
Reset time		t _r		—	—	1	μs
Reset LOW pulse width	RES	t _{rw}		1	—	—	μs

Note : All timing is specified with 20% and 80% of V_{DD} as the standard.

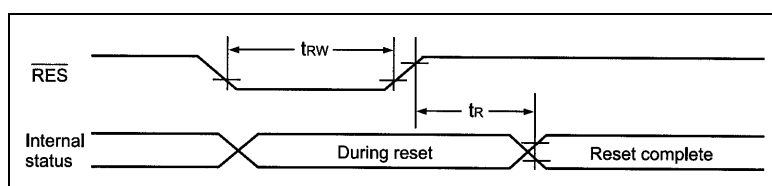

Figure 8: Reset Timing

6. Command Table

Table 10

Command	Command Code										Function			
	A0	RD	WR	D7	D6	D5	D4	D3	D2	D1		D0		
(1) Display ON/OFF	0	1	0	1	0	1	0	1	1	1	0	1	LCD display ON/OFF 0: OFF, 1: ON	
(2) Display start line set	0	1	0	0	1	Display start address					1	Sets the display RAM display start line address		
(3) Page address set	0	1	0	1	0	1	1	Page address				1	Sets the display RAM page address	
(4) Column address set upper bit	0	1	0	0	0	0	1	Most significant column address			1	Sets the most significant 4 bits of the display RAM column address.		
Column address set lower bit	0	1	0	0	0	0	0	Least significant column address			1	Sets the least significant 4 bits of the display RAM column address.		
(5) Status read	0	0	1	Status			0	0	0	0	0	0	Reads the status data	
(6) Display data write	1	1	0	Write data								1	Writes to the display RAM	
(7) Display data read	1	0	1	Read data								1	Reads from the display RAM	
(8) ADC select	0	1	0	1	0	1	0	0	0	0	0	1	Sets the display RAM address SEG output correspondence 0: normal, 1: reverse	
(9) Display normal/reverse	0	1	0	1	0	1	0	0	1	1	0	1	Sets the LCD display normal/reverse 0: normal, 1: reverse	
(10) Display all points ON/OFF	0	1	0	1	0	1	0	0	1	0	0	1	Display all points 0: normal display 1: all points ON	
(11) LCD bias set	0	1	0	1	0	1	0	0	0	1	0	1	Sets the LCD drive voltage bias ratio S1D10605***** 0: 1/9, 1: 1/7 S1D10606***** /S1D10608***** /S1D10609***** ... 0: 1/8, 1: 1/6 S1D10607***** 0: 1/6, 1: 1/5	
(12) Read/modify/write	0	1	0	1	1	1	0	0	0	0	0	0	Column address increment At write: +1 At read: 0	
(13) End	0	1	0	1	1	1	0	1	1	1	0	0	Clear read/modify/write	
(14) Reset	0	1	0	1	1	1	0	0	0	1	0	0	Internal reset	
(15) Common output mode select	0	1	0	1	1	0	0	0	*	*	*	*	Select COM output scan direction 0: normal direction, 1: reverse direction	
(16) Power control set	0	1	0	0	0	1	0	1	Operating mode			1	Select internal power supply operating mode	
(17) Vs voltage regulator internal resistor ratio set	0	1	0	0	0	1	0	0	Resistor ratio			1	Select internal resistor ratio (Rb/Ra) mode	
(18) Electronic volume mode set	0	1	0	1	0	0	0	0	0	0	0	1	Set the Vs output voltage electronic volume register	
Electronic volume register set	0	1	0	*	*	Electronic volume value					1			
(19) Static indicator ON/OFF	0	1	0	1	0	1	0	1	1	0	0	1	0: OFF, 1: ON	
Static indicator register set	0	1	0	*	*	*	*	*	*	Mode			1	Set the flashing mode
(20) Power saver													Display OFF and display all points ON compound command	
(21) NOP	0	1	0	1	1	1	0	0	0	1	1	1	Command for non-operation	
(22) Test	0	1	0	1	1	1	1	*	*	*	*	*	Command for IC test. Do not use this command	

(Note) *: disabled data

7. APPENDIX – LED Specifications

1. 极限参数 ABSOLUTE MAXIMUM RATINGS

(除非特别说明,环境温度 Ta=25°C. Unless specified, The Ambient temperature Ta=25°C)

项目 Item	符号 Symbol	条件 Conditions	值 Rating	单位 Unit
* 极限直流正向电流 Absolute maximum forward current	Ifm		2X25	mA
* 脉冲驱动时极限正向电流 Peak forward current	Ifp	1 msec 脉冲, 1/10 占空比 1 msec Plus 10% Duty Cycle	2X60	mA
反向电压 Reverse Voltage	Vr		5.0	V
* 极限功耗 Power dissipation	Pd		2X100	mW
工作温度 Operating Temperature Range	Topr		-30~+70°C	°C
贮存温度 Storage Temperature Range	Tstg		-40~+80°C	°C

- * 当工作温度高于 25°C 时, Ifm, Ifp 和 Pd 必须降低; 电流降低率是 -2X0.36 mA/°C (直流驱动), 或 -2X0.86 mA/°C (脉冲驱动), 功耗降低率是 -2X0.75 mW/°C. 产品的工作电流不能大于对应工作温度条件 Ifm 或 Ifp 的 60 %.
- For operation above 25°C, The Ifm Ifp & Pd must be derated, the Current derating is -2X0.36 mA/°C for DC drive and -2X0.86 mA/°C for Pulse drive, the Power dissipation is -2X0.75 mW/°C. The product working current must not more than the 60 % of the Ifm or Ifp according to the working temperature.

2. 电、光特性 ELECTRICAL-OPTICAL CHARACTERISTICS

(除非特别说明,环境温度 Ta=25°C. Unless specified, The Ambient temperature Ta=25°C)

项目 Item	符号 Symbol	最小值 min.	典型值 typ.	最大值 max.	单位 Unit	测定条件 Condition
正向电压 Forward Voltage	Vf	3.2	3.6	4.0	V	If= 2X15 mA
反向电流 Reverse Current	Ir			2X15	μA	Vr= 3 V
峰值波长 Peak wave length	λP				nm	If= 2X15 mA
频谱半宽度 Spectral Line Half width	Δλ				nm	If= 2X15 mA
* 亮度 Luminance	Lv	150			cd/m²	If= 2X15 mA

- * 亮度值是 9 个测量点的平均值, 亮度最大值比最小值一般小于 1.7 (最大 1.9).
使用 BM-7 亮度色度仪测量, 测量光圈 φ 10 mm.

The luminance is the average value of 9 points, and The Lvmax./Lvmin. is less than 1.7 Typical (max 1.9).
The measurement instrument is BM-7 luminance Colorimeter. The aperture is φ 10 mm.

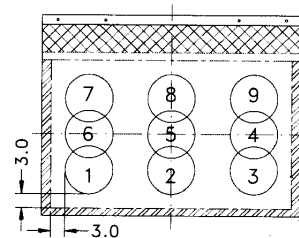

20030624

色度坐标值见下表: △

Colour Coordinate see the chart:

	Rank B1 Limiting Region				Rank B2 Limiting Region			
X	0.287	0.283	0.330	0.330	0.296	0.287	0.330	0.330
Y	0.295	0.305	0.360	0.339	0.276	0.295	0.339	0.318

注: 色度坐标值公差±0.02

每批出货产品的色度坐标只能在B1区或只能在B2区。

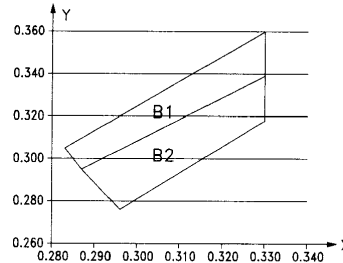

3. STATIC ELECTRICITY AND SURGE

- * Static electricity and surge will damage the LEDs. It is recommended to use a wrist band or anti-electrostatic glove when handling the LEDs.
- * All devices, equipment and machinery must be properly grounded.
- * When inspecting own final products on which LEDs were mounted, it is recommended to check also whether the mounted LEDs are damaged by static electricity or not. It is easy to find static-damaged LEDs by light emission test at lower current (below 1mA is recommended). Damaged LEDs will show some unusual characteristics such as leak current remarkably increases, starting forward voltage becomes lower, or the LEDs get unlighted at the low current.

4. RECOMMEND CONNECTION OF STATIC-ELECTRICITY RESISTANCE

- * This circuit diagram is a common ESD protection circuit for all super bright blue, white and green color LED backlight application.

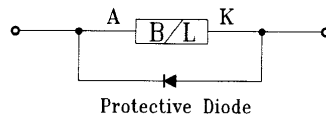

5. LED ELECTRICAL CHARACTERISTICS

(1) 正向电流-周围温度

Forward Current VS. Ambient Temperature

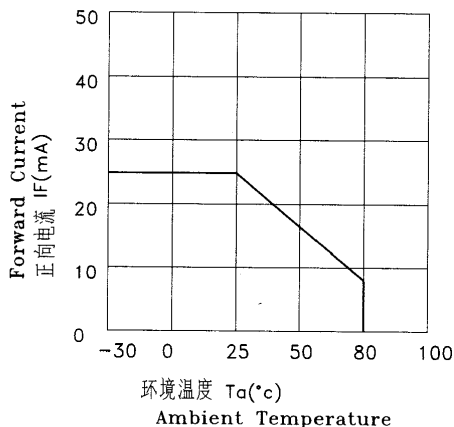

(2) 正向电流-正向电压特性

Forward Current VS. Forward Voltage

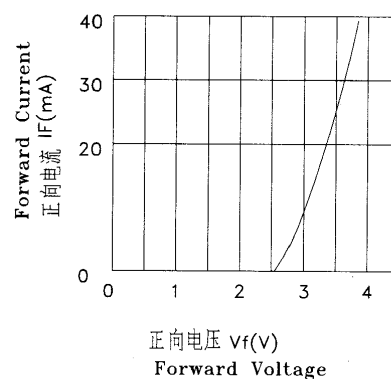

20030624