

Category 3, EN 954-1 PNOZ 1

Farnell Code: 530578

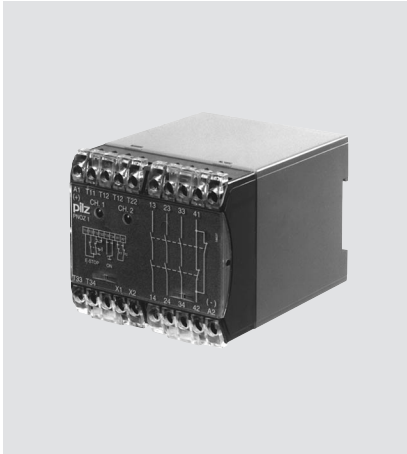

Emergency stop relay and safety gate monitor in accordance with VDE 0113-1, 11/98, EN 60204-1, 12/97 and IEC 204-1, 11/98.

Features

- Single-channel or dual-channel without detection of shorts across the input contacts
- Not designed for operation via semiconductor outputs

Approvals

	PNOZ 1
	●
	●
	●
Arbejdstilsynet Dänemark	●
	●

Technical Details	PNOZ 1
Electrical Data	
Supply Voltage	AC: 24, 42, 48, 110, 115, 120, 230, 240 V DC: 24 V
Tolerance	85 ... 110 %
Power Consumption	≤ 3.5 W/6 VA
Voltage and Current at the Input and, Reset Circuits and Feedback Control Loop	24 VDC, 50 mA
Switching Capability in accordance with EN 60947-4-1, 10/91	AC1: 240 V/8 A/2000 VA 400 V/5 A/2000 VA DC1: 24 V/8 A/200 W
EN 60947-5-1, 10/91 (DC13: 6 cycles/min.)	AC15: 230 V/5 A; DC13: 24 V/7A
Output Contacts	3 safety contacts (N/O) 1 auxiliary contact (N/C)
Contact Fuse Protection (EN 60947-5-1, 10/91)	10 A quick or 6 A slow
Times	
Delay-on Energisation	Max. 250 ms
Delay-on De-energisation	Max. 50 ms
Recovery Time	Approx. 0.3 s
Simultaneity channel 1/2	Approx 140 ms
Max. Supply Interruption before De-energisation	Approx. 35 ms
Mechanical Data	
Torque Setting on Connection Terminals	1.2 Nm (screws)
Maximum Cross Section of External Conductors	2 x 2.5 mm ² Single-core or multi-core with crimp connectors
Dimensions (H x W x D)	75 x 90 x 110 mm
Weight	AC: 460 g, DC: 360 g

Description

- 90 mm, P-75-housing, DIN-Rail mounting
- Positive-guided relay outputs:
 - 3 safety contacts (N/O)
 - 1 auxiliary contact (N/C)
- Connections for
 - E-STOP button
 - safety gate limit switch
 - reset button
- LEDs for channel 1 and channel 2
- Increase in the number of safety contacts available by connecting expander modules.

Operating Modes

- Single-channel operation
- Dual-channel operation
- Automatic reset
- Manual reset

Category 3, EN 954-1 PNOZ 1

Internal Wiring Diagram

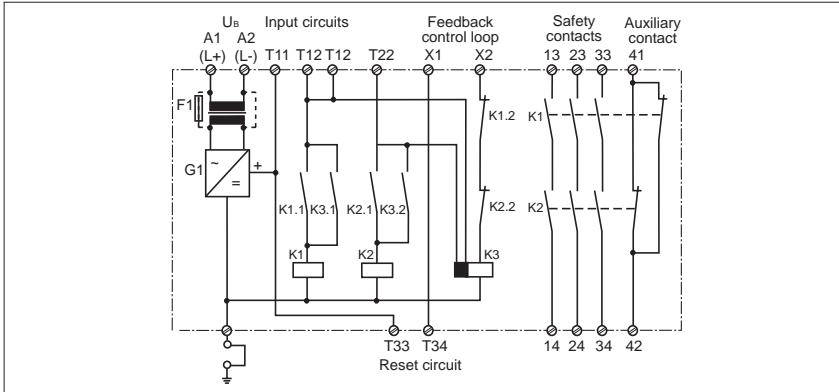

- Increase in safety contacts
The number of output contacts can be increased by using expander modules or relays/contactors with positive-guided contacts.

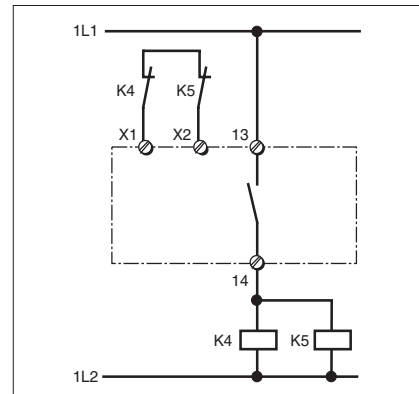

External Wiring

- Example 1
Single-channel E-STOP wiring with manual reset.

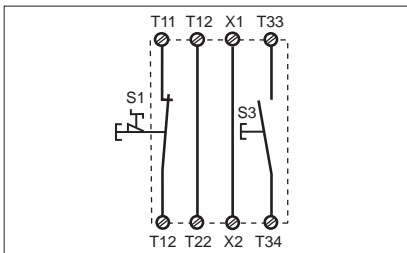

- Example 4
Dual-channel safety gate control with manual reset.

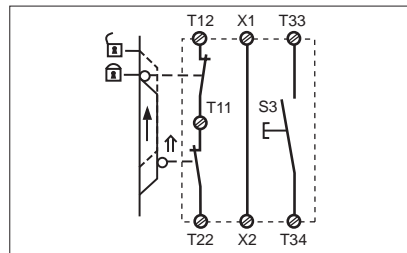

- Example 2
Dual-channel E-STOP wiring with manual reset.

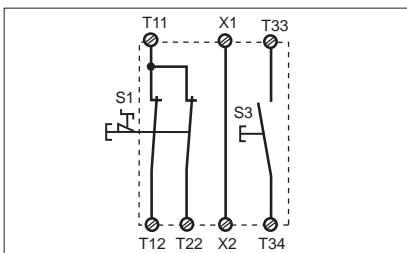

- Example 5
Dual-channel safety gate control with automatic reset.

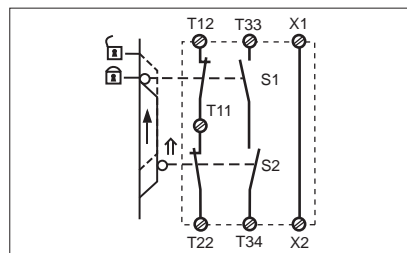

- Example 3
Single-channel safety gate control with manual reset.

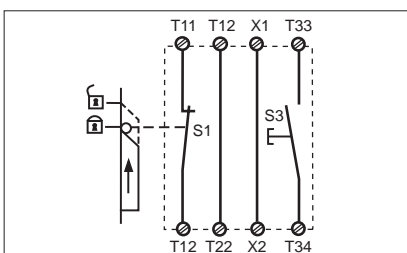

– Key

- S1/2: E-STOP or safety gate switch
- S3: Reset button
- ↑ Switch operated
- ⬆ Gate open
- ⬆ Gate closed

Category 3, EN 954-1 PNOZ 1

General Technical Data

Unless stated otherwise in the technical details for the specific unit

Electrical Data

Frequency Range AC	50 ... 60 Hz
Residual Ripple DC	160 %
Contact Material	AgSnO ₂
Continuous Duty	100 %

Environmental Data

EMC	EN 50081-1, 01/92, EN 50082-2, 03/95
Vibration in accordance with EN 60068-2-6, 04/95	Frequency: 10 ... 55 Hz, Amplitude: 0.35 mm
Climatic Suitability	DIN IEC 60068-2-3, 12/86
Airgap Creepage	DIN VDE 0110 part 1, 04/97
Ambient Temperature	-10 ... +55 °C
Storage Temperature	-40 ... +85 °C

Mechanical Data

Torque Setting on Connection Terminals	0.6 Nm (screws)
Mounting Position	Any
Housing Material	Thermoplast Noryl SE 100
Protection	Mounting: IP 54 Housing: IP 40 Terminal Range: IP 20

The units were tested in accordance with the relevant standards current at the time of development.

Order References

Type	U _B	Order No.
PNOZ 1	24 V DC	475 695
PNOZ 1	24 V AC	475 600
PNOZ 1	42 V AC	475 610
PNOZ 1	48 V AC	475 620
PNOZ 1	110 V AC	475 630
PNOZ 1	115 V AC	475 635
PNOZ 1	120 V AC	475 640
PNOZ 1	230 V AC	475 650
PNOZ 1	240 V AC	475 655