

## 138-mW DIRECTPATH™ STEREO HEADPHONE AMPLIFIER WITH I<sup>2</sup>C VOLUME CONTROL

### FEATURES

- **DirectPath™ Ground-Referenced Outputs**
  - Eliminates Output DC Blocking Capacitors
  - Reduces Board Area
  - Reduces Component Height and Cost
  - Full Bass Response Without Attenuation
- **Power Supply Voltage Range: 2.5 V to 5.5 V**
- **64 Step Audio Taper Volume Control**
- **High Power Supply Rejection Ratio (>100 dB PSRR)**
- **Differential Inputs for Maximum Noise Rejection (68 dB CMRR)**
- **High-Impedance Outputs When Disabled**
- **Advanced Pop and Click Suppression Circuitry**
- **Digital I<sup>2</sup>C Bus Control**
  - Per Channel Mute and Enable
  - Software Shutdown
  - Multi-Mode Support: Stereo HP, Dual Mono HP, and Single-Channel BTL Operation
  - Amplifier Status
- **Space Saving Packages**
  - 20 Pin, 4 mm x 4 mm QFN
  - 16 ball, 2 mm x 2 mm WCSP
- **ESD Protection of 8 kV HBM and IEC Contact**

### APPLICATIONS

- Mobile Phones
- Portable Media Players
- Notebook Computers
- High Fidelity Applications

### DESCRIPTION

The TPA6130A2 is a stereo DirectPath™ headphone amplifier with I<sup>2</sup>C digital volume control. The TPA6130A2 has minimal quiescent current consumption, with a typical I<sub>DD</sub> of 4 mA, making it optimal for portable applications. The I<sup>2</sup>C control allows maximum flexibility with a 64 step audio taper volume control, channel independent enables and mutes, and the ability to configure the outputs into stereo, dual mono, or a single receiver speaker BTL amplifier that drives 300 mW of power into 16 Ω loads.

The TPA6130A2 is a high fidelity amplifier with an SNR of 98 dB. A PSRR greater than 100 dB enables direct-to-battery connections without compromising the listening experience. The output noise of 9 μVrms (typical *A-weighted*) provides a minimal noise background during periods of silence. Configurable differential inputs and high CMRR allow for maximum noise rejection in the noisy environment of a mobile device.

TPA6130A2 packaging includes a 2 by 2 mm chip-scale package, and a 4 by 4 mm QFN package.

### SIMPLIFIED APPLICATION DIAGRAM

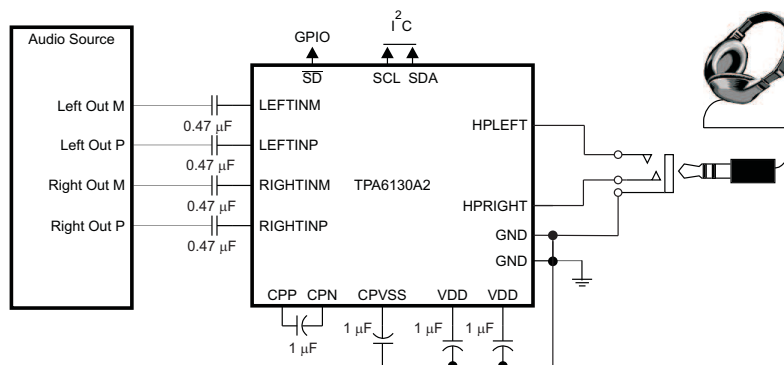

Please be aware that an important notice concerning availability, standard warranty, and use in critical applications of Texas Instruments semiconductor products and disclaimers thereto appears at the end of this data sheet.

DirectPath is a trademark of Texas Instruments.



These devices have limited built-in ESD protection. The leads should be shorted together or the device placed in conductive foam during storage or handling to prevent electrostatic damage to the MOS gates.

**FUNCTIONAL BLOCK DIAGRAM**

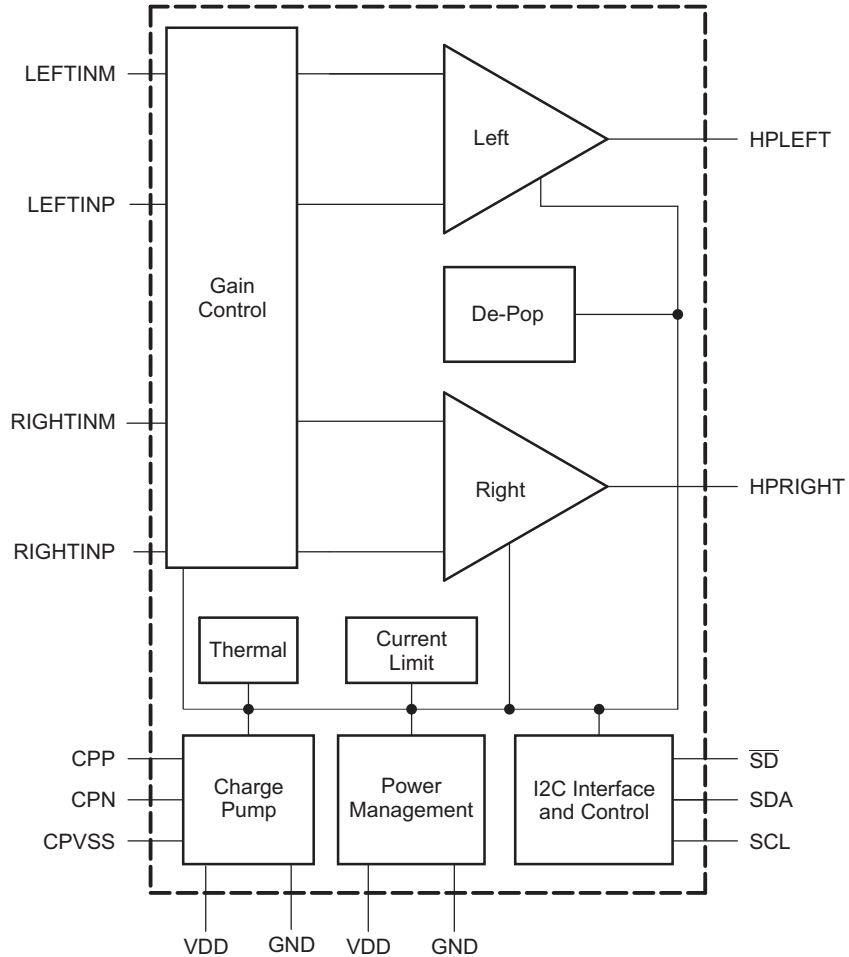

Headphone channels are independently enabled and muted. The I<sup>2</sup>C interface controls channel gain, device modes, and charge pump activation. The charge pump generates a negative supply voltage for the output amplifiers. This allows a 0 V bias at the outputs, eliminating the need for bulky output capacitors. The thermal block detects faults and shuts down the device before damage occurs. The I<sup>2</sup>C register records thermal fault conditions. The current limit block prevents the output current from getting high enough to damage the device. The De-Pop block eliminates audible pops during power-up, power-down, and amplifier enable and disable events.

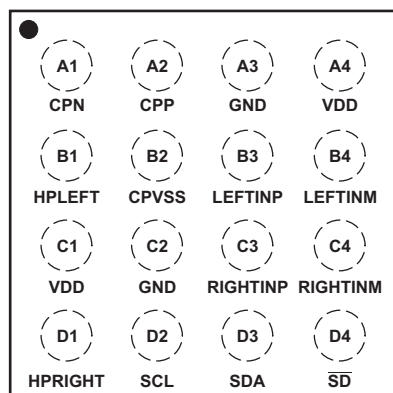

Top (Symbol Side) View WCSP Package (YZH)

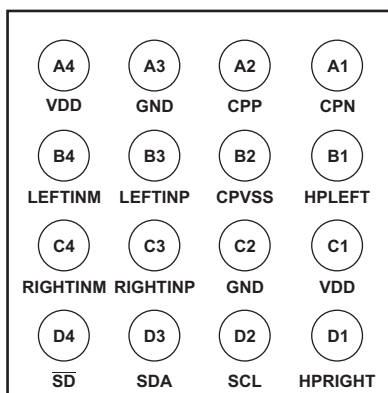

Bottom (Ball Side) View WCSP Package (YZH)

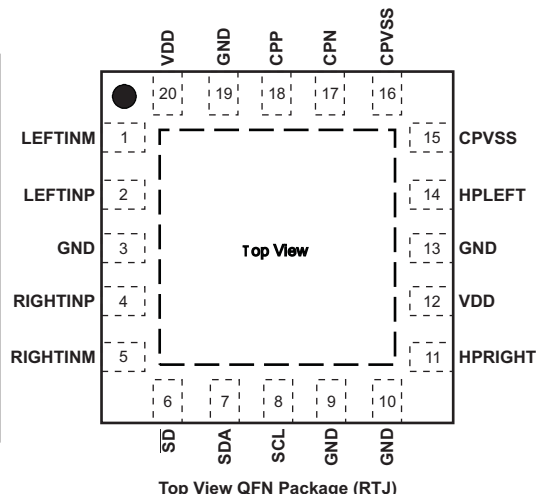

Top View QFN Package (RTJ)

### TERMINAL FUNCTIONS

TERMINAL			INPUT/ OUTPUT/ POWER (I/O/P)	DESCRIPTION
NAME	BALL WCSP	PIN QFN		
V <sub>DD</sub>	A4	20	P	Charge pump voltage supply. V <sub>DD</sub> must be connected to the common V <sub>DD</sub> voltage supply. Decouple to GND (pin 19 on the QFN) with its own 1 μF capacitor.
GND	A3	19	P	Charge pump ground. GND must be connected to common supply GND. It is recommended that this pin be decoupled to the V <sub>DD</sub> of the charge pump pin (pin 20 on the QFN).
CPP	A2	18	P	Charge pump flying capacitor positive terminal. Connect one side of the flying capacitor to CPP.
CPN	A1	17	P	Charge pump flying capacitor negative terminal. Connect one side of the flying capacitor to CPN.
LEFTINM	B4	1	I	Left channel negative differential input. Impedance must be matched to LEFTINP. Connect the left input to LEFTINM when using single-ended inputs.
LEFTINP	B3	2	I	Left channel positive differential input. Impedance must be matched to LEFTINM. AC ground LEFTINP near signal source while maintaining matched impedance to LEFTINM when using single-ended inputs.
CPVSS	B2	15, 16	P	Negative supply generated by the charge pump. Decouple to pin 19 on the QFN or a GND plane. Use a 1 μF capacitor.
HPLEFT	B1	14	O	Headphone left channel output. Connect to left terminal of headphone jack.
RIGHTINM	C4	5	I	Right channel negative differential input. Impedance must be matched to RIGHTINP. Connect the right input to RIGHTINM when using single-ended inputs.
RIGHTINP	C3	4	I	Right channel positive differential input. Impedance must be matched to RIGHTINM. AC ground RIGHTINP near signal source while maintaining matched impedance to RIGHTINM when using single-ended inputs.
GND	C2	3, 9, 10, 13	P	Analog ground. Must be connected to common supply GND. It is recommended that this pin be used to decouple V <sub>DD</sub> for analog. Use pin 13 to decouple pin 12 on the QFN package.
V <sub>DD</sub>	C1	12	P	Analog V <sub>DD</sub> . V <sub>DD</sub> must be connected to common V <sub>DD</sub> supply. Decouple with its own 1-μF capacitor to analog ground (pin 13 on the QFN).
SD	D4	6	I	Shutdown. Active low logic. 5V tolerant input.
SDA	D3	7	I/O	SDA - I <sup>2</sup> C Data. 5V tolerant input.
SCL	D2	8	I	SCL - I <sup>2</sup> C Clock. 5V tolerant input.
HPRIGHT	D1	11	O	Headphone right channel output. Connect to the right terminal of the headphone jack.
Thermal pad	N/A	Die Pad	P	Solder the thermal pad on the bottom of the QFN package to the GND plane of the PCB. It is required for mechanical stability and will enhance thermal performance.

**ABSOLUTE MAXIMUM RATINGS<sup>(1)</sup>**over operating free-air temperature range,  $T_A = 25^\circ\text{C}$  (unless otherwise noted)

		VALUE / UNIT
Supply voltage, $V_{DD}$		–0.3 V to 6.0 V
$V_I$	Input voltage	RIGHTINx, LEFTINx
		$\overline{SD}$ , SCL, SDA
Output continuous total power dissipation		See Dissipation Rating Table
$T_A$	Operating free-air temperature range	–40°C to 85°C
$T_J$	Operating junction temperature range	–40°C to 125°C
$T_{stg}$	Storage temperature range	–65°C to 150°C
Lead temperature 1,6 mm (1/16 inch) from case for 10 seconds		260°C
ESD Protection	HBM Output Pins	8 kV
	HBM All Other Pins	3.5 kV
IEC Contact ESD Protection <sup>(2)</sup>	No External Protection	8 kV
	V14MLA0603 Varistors Used for External Protection	15 kV
Minimum Load Impedance		12.8 $\Omega$

- (1) Stresses beyond those listed under *absolute maximum ratings* may cause permanent damage to the device. These are stress ratings only, and functional operation of the device at these or any other conditions beyond those indicated under *recommended operating conditions* is not implied. Exposure to absolute-maximum-rated conditions for extended periods may affect device reliability.
- (2) Tested to IEC 61000-4-2 standards on a TPA6130A2 EVM.

**DISSIPATION RATINGS TABLE**

PACKAGE	$T_A \leq 25^\circ\text{C}$ POWER RATING	DERATING FACTOR <sup>(1) (2)</sup>	$T_A = 70^\circ\text{C}$ POWER RATING	$T_A = 85^\circ\text{C}$ POWER RATING
RTJ	4100 mW	41 mW/°C	2250 mW	1640 mW
YZH	970 mW	9.7 mW/°C	530 mW	390 mW

- (1) Derating factor measured with JEDEC High K board: 1S2P - One signal layer and two plane layers.
- (2) See JEDEC Standard 51-3 for Low-K board, JEDEC Standard 51-7 for High-K board, and JEDEC Standard 51-12 for using package thermal information. Please see JEDEC document page for downloadable copies: <http://www.jedec.org/download/default.cfm>.

**AVAILABLE OPTIONS**

$T_A$	PACKAGED DEVICES <sup>(1)</sup>	PART NUMBER	SYMBOL
–40°C to 85°C	20-pin, 4 mm × 4 mm QFN	TPA6130A2RTJ <sup>(2)</sup>	BSG
	16-ball, 1,98 mm × 1.98 mm (+0,01mm, –0,09 mm)	TPA6130A2YZH	BRU

- (1) For the most current package and ordering information, see the Package Option Addendum at the end of this document, or see the TI Web site at [www.ti.com](http://www.ti.com).
- (2) The RTJ package is only available taped and reeled. To order, add the suffix "R" to the end of the part number for a reel of 3000, or add the suffix "T" to the end of the part number for a reel of 250 (e.g., TPA6130A2RTJR).

**RECOMMENDED OPERATING CONDITIONS**

		MIN	MAX	UNIT
Supply voltage, $V_{DD}$		2.5	5.5	V
$V_{IH}$	High-level input voltage	SCL, SDA, $\overline{SD}$		V
$V_{IL}$	Low-level input voltage	SCL, SDA		0.6
		$\overline{SD}$		0.35
$T_A$	Operating free-air temperature	–40	85	°C

## ELECTRICAL CHARACTERISTICS

$T_A = 25^\circ\text{C}$  (unless otherwise noted)

PARAMETER		TEST CONDITIONS	MIN	TYP	MAX	UNIT
VOS	Output offset voltage	$V_{DD} = 2.5\text{ V to }5.5\text{ V}$ , inputs grounded		150	400	$\mu\text{V}$
PSRR	Power supply rejection ratio	$V_{DD} = 2.5\text{ V to }5.5\text{ V}$ , inputs grounded		-109	-90	dB
CMRR	Common mode rejection ratio	$V_{DD} = 2.5\text{ V to }5.5\text{ V}$		-68		dB
I <sub>IH</sub>	High-level input current	$V_{DD} = 5.5\text{ V}$ , $V_I = V_{DD}$	SCL, SDA		1	$\mu\text{A}$
			$\overline{\text{SD}}$		10	
I <sub>IL</sub>	Low-level input current	$V_{DD} = 5.5\text{ V}$ , $V_I = 0\text{ V}$	SCL, SDA, $\overline{\text{SD}}$		1	$\mu\text{A}$
I <sub>DD</sub>	Supply current	$V_{DD} = 2.5\text{ V to }5.5\text{ V}$ , $\overline{\text{SD}} = V_{DD}$		4	6	mA
		Shutdown mode, $V_{DD} = 2.5\text{ V to }5.5\text{ V}$ , $\overline{\text{SD}} = 0\text{ V}$		0.4	1	$\mu\text{A}$
		SW Shutdown mode, $V_{DD} = 2.5\text{ V to }5.5\text{ V}$ , SWS = 1		25	75	$\mu\text{A}$
		Both HP amps disabled, $V_{DD} = 2.5\text{ V to }5.5\text{ V}$ , SWS = 0, Charge Pump enabled, $\overline{\text{SD}} = V_{DD}$		1.4	2.5	mA

## TIMING CHARACTERISTICS<sup>(1)(2)</sup>

For I<sup>2</sup>C Interface Signals Over Recommended Operating Conditions (unless otherwise noted)

PARAMETER		TEST CONDITIONS	MIN	TYP	MAX	UNIT
f <sub>SCL</sub>	Frequency, SCL	No wait states			400	kHz
t <sub>w(H)</sub>	Pulse duration, SCL high		0.6			$\mu\text{s}$
t <sub>w(L)</sub>	Pulse duration, SCL low		1.3			$\mu\text{s}$
t <sub>su1</sub>	Setup time, SDA to SCL		300			ns
t <sub>h1</sub>	Hold time, SCL to SDA		10			ns
t <sub>(buf)</sub>	Bus free time between stop and start condition		1.3			$\mu\text{s}$
t <sub>su2</sub>	Setup time, SCL to start condition		0.6			$\mu\text{s}$
t <sub>h2</sub>	Hold time, start condition to SCL		0.6			$\mu\text{s}$
t <sub>su3</sub>	Setup time, SCL to stop condition		0.6			$\mu\text{s}$

(1)  $V_{\text{Pull-up}} = V_{DD}$

(2) A pull-up resistor  $\leq 2\text{ k}\Omega$  is required for a 5 V I<sup>2</sup>C bus voltage.

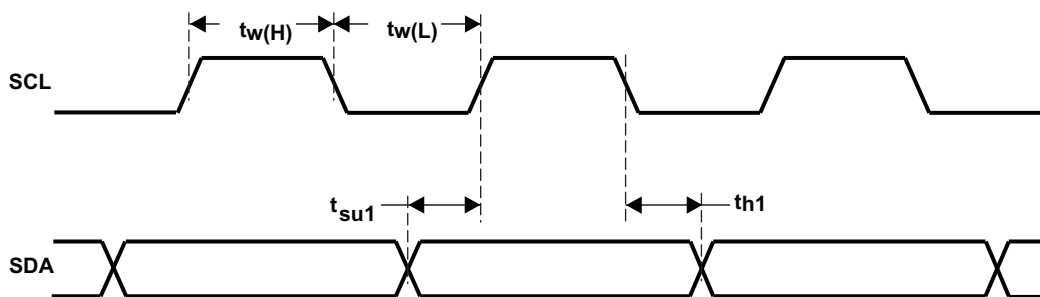

Figure 1. SCL and SDA Timing

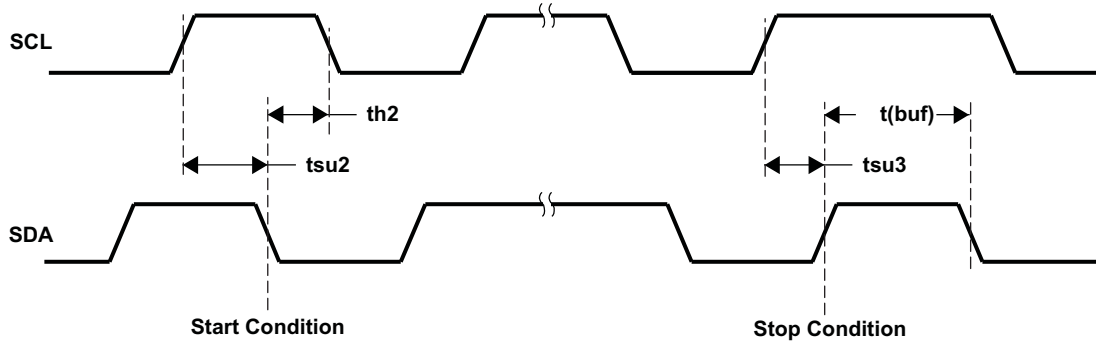

Figure 2. Start and Stop Conditions Timing

**OPERATING CHARACTERISTICS**

V<sub>DD</sub> = 3.6 V , T<sub>A</sub> = 25°C, R<sub>L</sub> = 16 Ω (unless otherwise noted)

PARAMETER	TEST CONDITIONS	MIN	TYP	MAX	UNIT
P <sub>O</sub> Output power	Stereo, Outputs out of phase, THD = 1%, f = 1 kHz, Gain = 0.1 dB	V <sub>DD</sub> = 2.5V	60		mW
		V <sub>DD</sub> = 3.6V	127		
		V <sub>DD</sub> = 5V	138		
	Bridge-tied load, THD = 1%, f = 1 kHz, Gain = 0.1 dB	V <sub>DD</sub> = 2.5V	110		
		V <sub>DD</sub> = 3.6V	230		
		V <sub>DD</sub> = 5V	290		
THD+N Total harmonic distortion plus noise	P <sub>O</sub> = 35 mW	f = 100 Hz	0.0029%		
		f = 1 kHz	0.0055%		
		f = 20 kHz	0.0027%		
k <sub>SVR</sub> Supply ripple rejection ratio	200 mV <sub>pp</sub> ripple, f = 217 Hz		-97	-90	dB
	200 mV <sub>pp</sub> ripple, f = 1 kHz		-93		
	200 mV <sub>pp</sub> ripple, f = 20 kHz		-76		
ΔA <sub>v</sub> Gain matching			1%		
Slew rate			0.3		V/μs
V <sub>n</sub> Noise output voltage	V <sub>DD</sub> = 3.6V, A-weighted, Gain = 0.1 dB		9		μV <sub>RMS</sub>
f <sub>osc</sub> Charge pump switching frequency		300	400	500	kHz
Start-up time from shutdown			5		ms
Differential input impedance	See <a href="#">Figure 33</a>				
SNR Signal-to-noise ratio	P <sub>O</sub> = 35 mW		98		dB
Thermal shutdown	Threshold		180		°C
	Hysteresis		35		°C
Z <sub>O</sub> Tri-state HP output impedance	HiZ left and right bits set. HP amps disabled. DC value.		25		MΩ
C <sub>O</sub> Output capacitance			80		pF

**TYPICAL CHARACTERISTICS**

$C_{(PUMP, DECOUPLE, BYPASS, CPVSS)} = 1 \mu F, C_I = 2.2 \mu F.$

All THD + N graphs taken with outputs out of phase (unless otherwise noted).

**Table of Graphs**

		FIGURE
Total harmonic distortion + noise	vs Output power	3–8
Total harmonic distortion + noise	vs Frequency	9–22
Supply voltage rejection ratio	vs Frequency	23–25
Common mode rejection ratio	vs Frequency	26–27
Output power	vs Load	28–29
Output voltage	vs Load	30–31
Power Dissipation	vs Output power	32
Differential Input Impedance	vs Gain	33
Shutdown time		34
Startup time		35

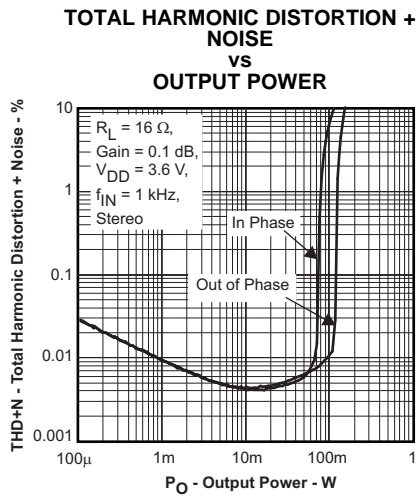

Figure 3.

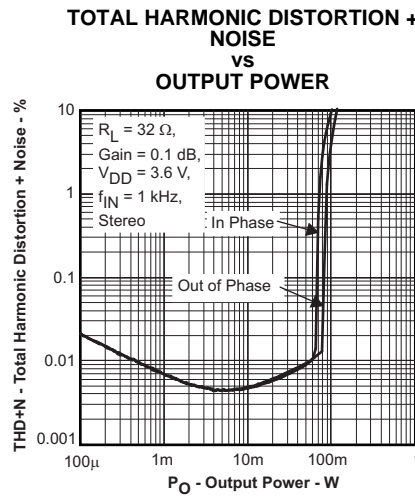

Figure 4.

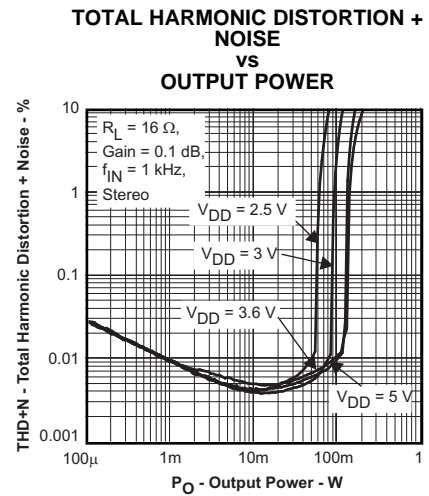

Figure 5.

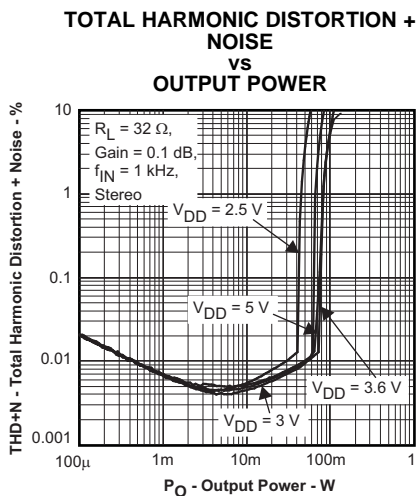

Figure 6.

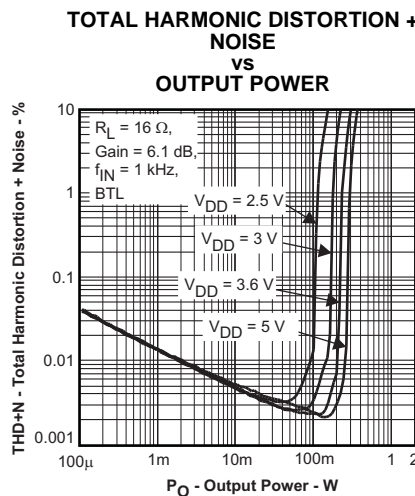

Figure 7.

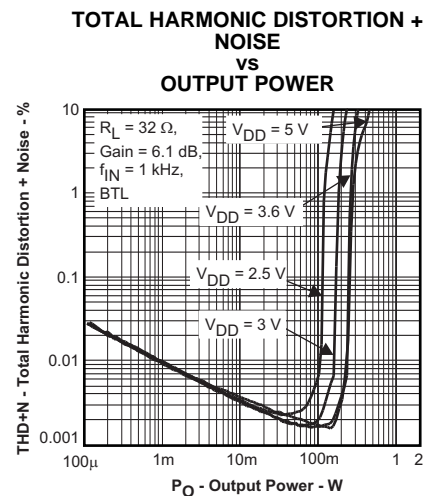

Figure 8.

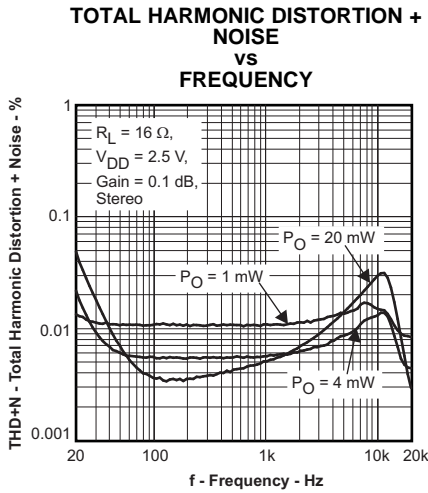

Figure 9.

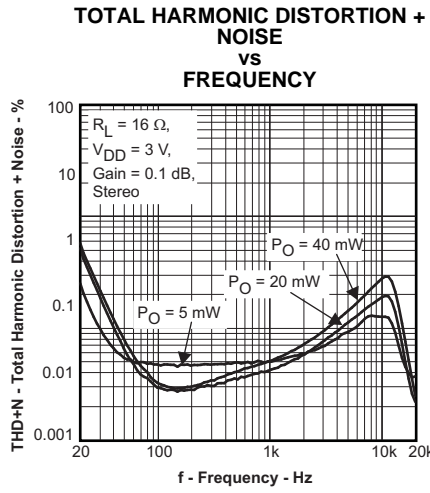

Figure 10.

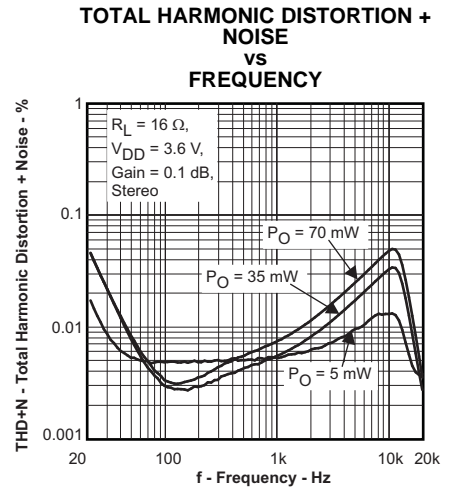

Figure 11.

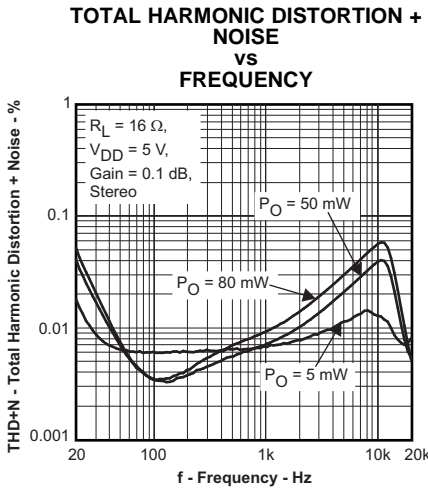

Figure 12.

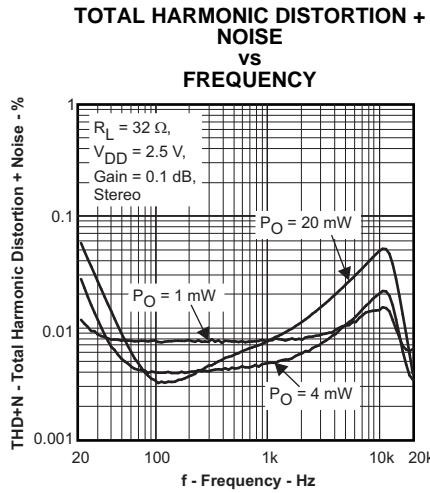

Figure 13.

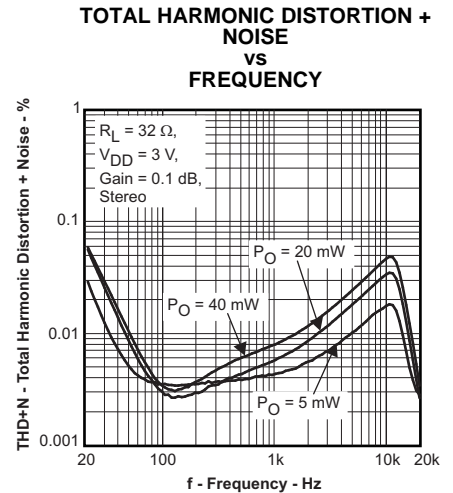

Figure 14.

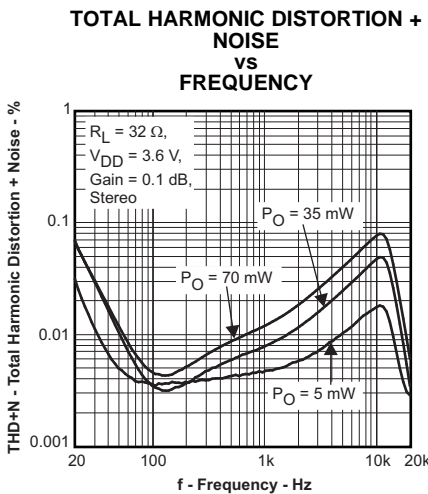

Figure 15.

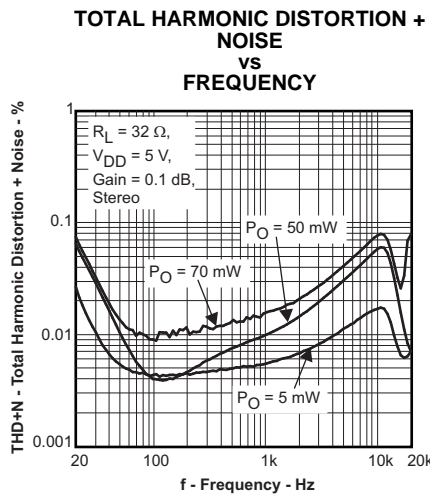

Figure 16.

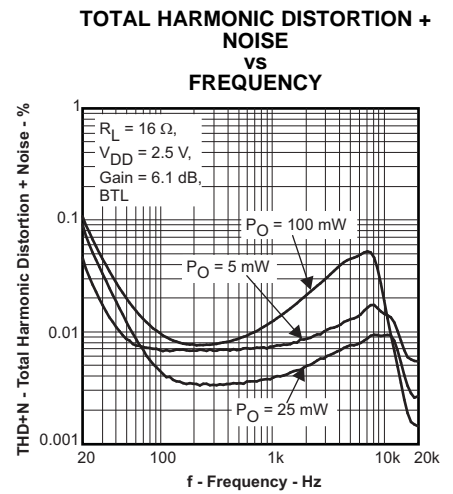

Figure 17.



**TOTAL HARMONIC DISTORTION + NOISE VS FREQUENCY**

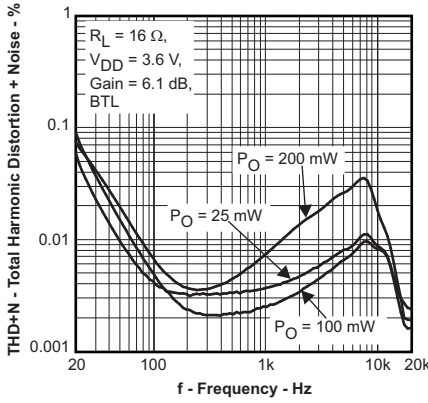

Figure 18.

**TOTAL HARMONIC DISTORTION + NOISE VS FREQUENCY**

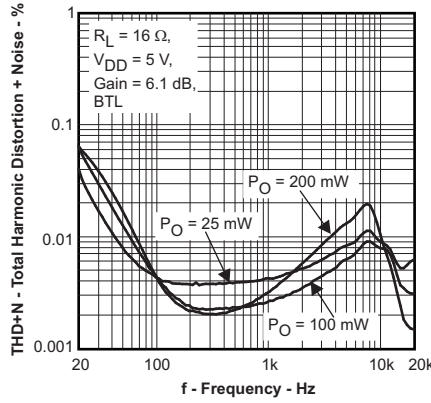

Figure 19.

**TOTAL HARMONIC DISTORTION + NOISE VS FREQUENCY**

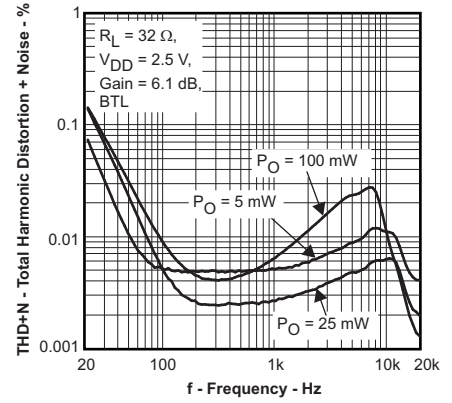

Figure 20.

**TOTAL HARMONIC DISTORTION + NOISE VS FREQUENCY**

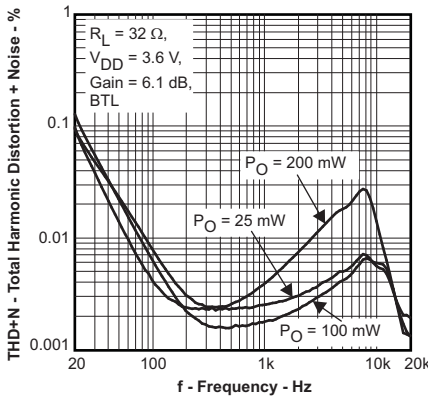

Figure 21.

**TOTAL HARMONIC DISTORTION + NOISE VS FREQUENCY**

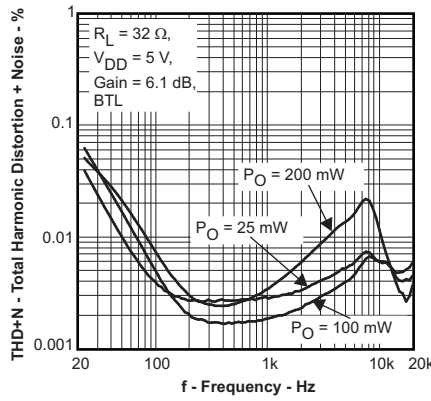

Figure 22.

**SUPPLY VOLTAGE REJECTION RATIO VS FREQUENCY**

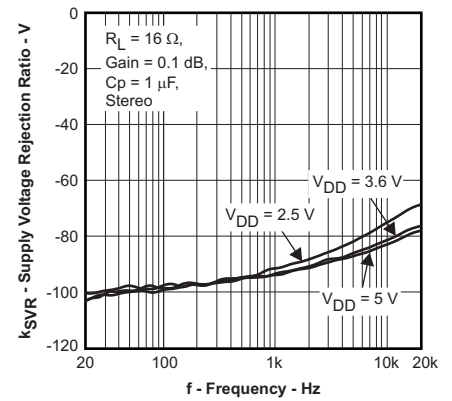

Figure 23.

**SUPPLY VOLTAGE REJECTION RATIO VS FREQUENCY**

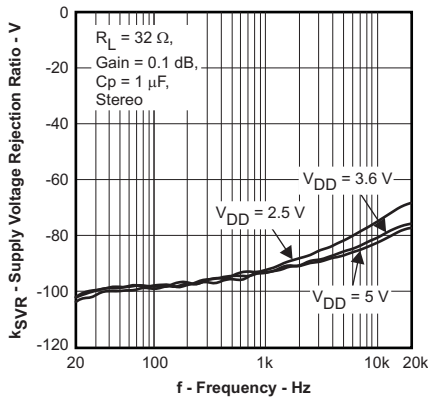

Figure 24.

**SUPPLY VOLTAGE REJECTION RATIO VS FREQUENCY**

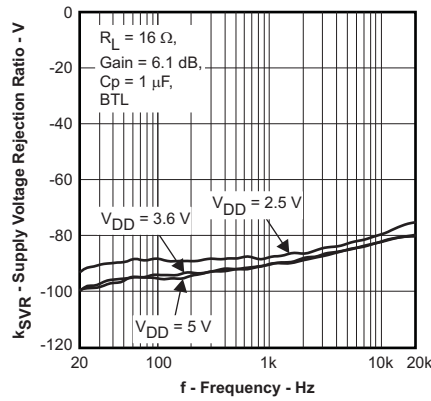

Figure 25.

**COMMON MODE REJECTION RATIO VS FREQUENCY**

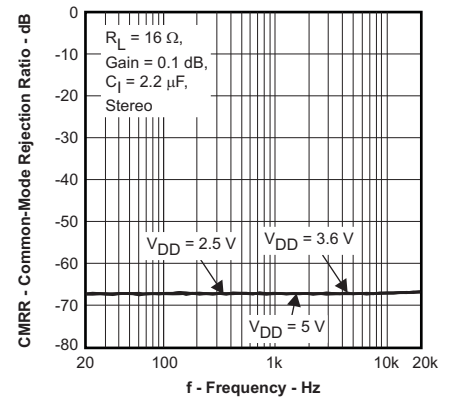

Figure 26.

**COMMON MODE REJECTION RATIO  
VS  
FREQUENCY**

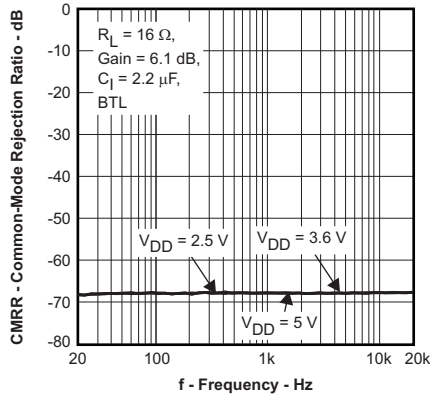

Figure 27.

**OUTPUT POWER  
VS  
LOAD**

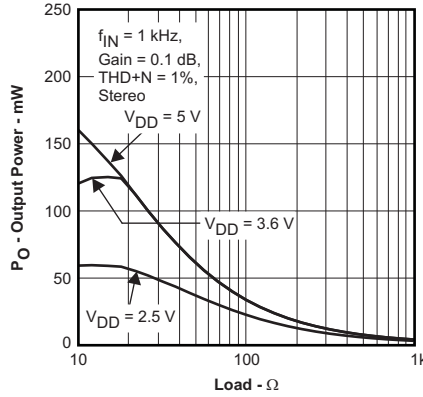

Figure 28.

**OUTPUT POWER  
VS  
LOAD**

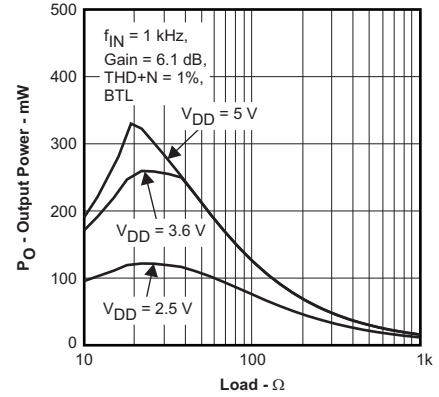

Figure 29.

**OUTPUT VOLTAGE  
VS  
LOAD**

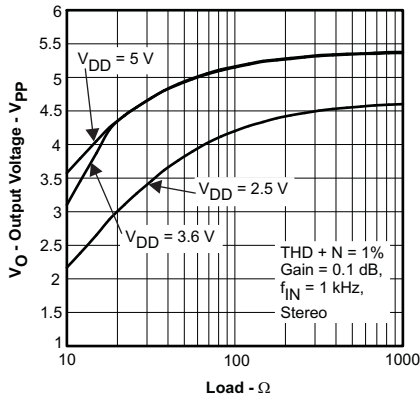

Figure 30.

**OUTPUT VOLTAGE  
VS  
LOAD**

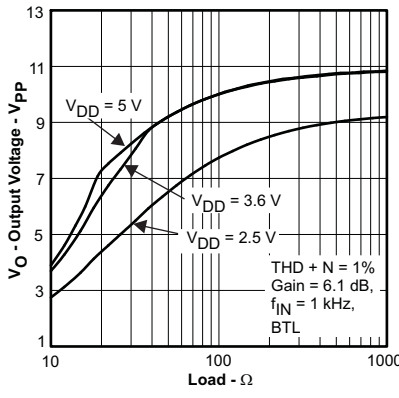

Figure 31.

**POWER DISSIPATION  
VS  
OUTPUT POWER**

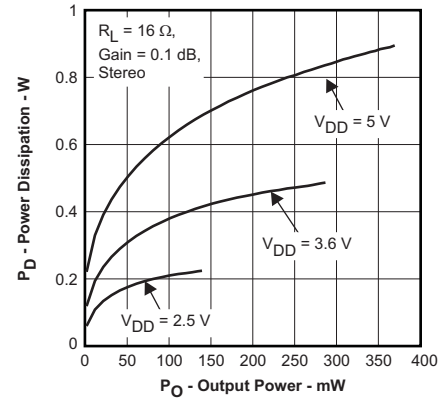

Figure 32.

**DIFFERENTIAL INPUT IMPEDANCE  
VS  
GAIN**

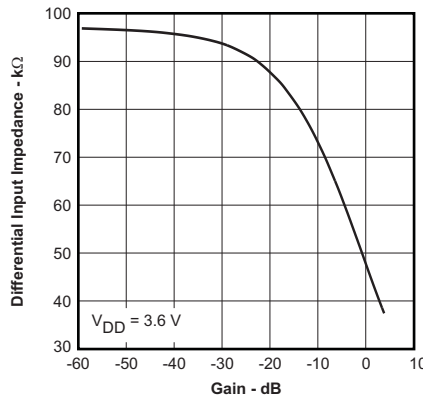

Figure 33.

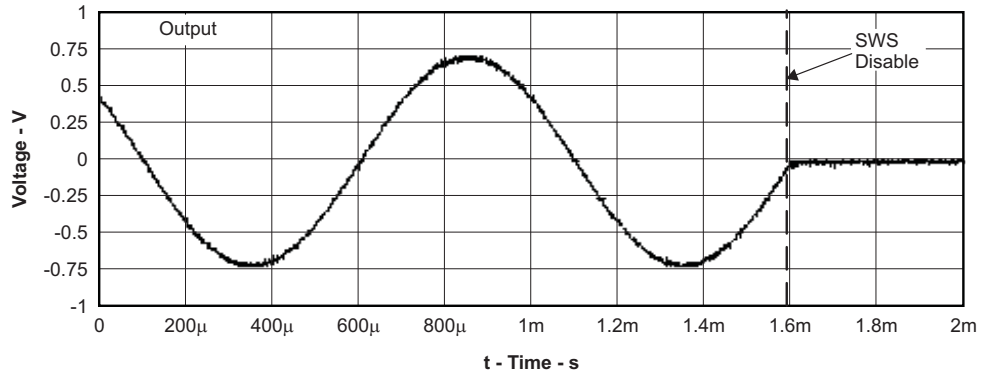

Figure 34. Shutdown Time

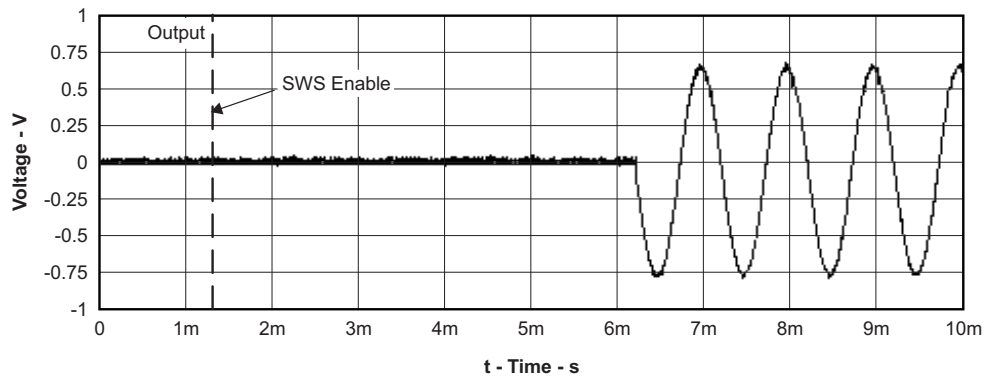
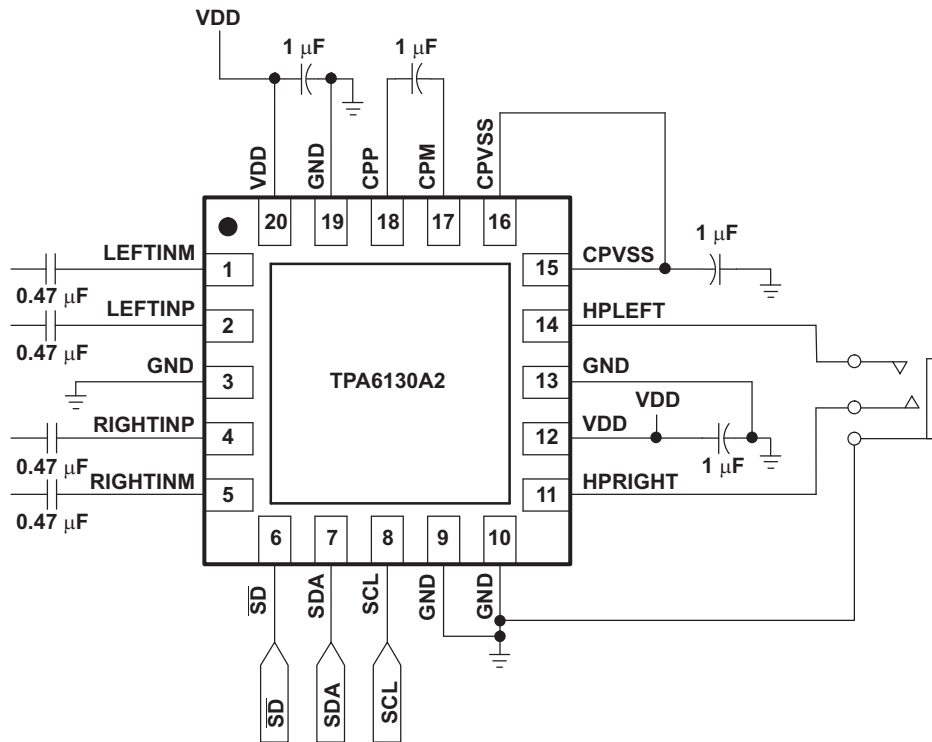

Figure 35. Startup Time

APPLICATION INFORMATION

SIMPLIFIED APPLICATIONS CIRCUIT



Headphone Amplifiers

Single-supply headphone amplifiers typically require dc-blocking capacitors. The capacitors are required because most headphone amplifiers have a dc bias on the outputs pin. If the dc bias is not removed, the output signal is severely clipped, and large amounts of dc current rush through the headphones, potentially damaging them. The top drawing in [Figure 36](#) illustrates the conventional headphone amplifier connection to the headphone jack and output signal.

DC blocking capacitors are often large in value. The headphone speakers (typical resistive values of 16 Ω or 32 Ω) combine with the dc blocking capacitors to form a high-pass filter. [Equation 1](#) shows the relationship between the load impedance (R<sub>L</sub>), the capacitor (C<sub>O</sub>), and the cutoff frequency (f<sub>c</sub>).

$$f_c = \frac{1}{2\pi R_L C_O} \tag{1}$$

C<sub>O</sub> can be determined using [Equation 2](#), where the load impedance and the cutoff frequency are known.

$$C_O = \frac{1}{2\pi R_L f_c} \tag{2}$$

If f<sub>c</sub> is low, the capacitor must then have a large value because the load resistance is small. Large capacitance values require large package sizes. Large package sizes consume PCB area, stand high above the PCB, increase cost of assembly, and can reduce the fidelity of the audio output signal.

Two different headphone amplifier applications are available that allow for the removal of the output dc blocking capacitors. The Capless amplifier architecture is implemented in the same manner as the conventional amplifier with the exception of the headphone jack shield pin. This amplifier provides a reference voltage, which is

connected to the headphone jack shield pin. This is the voltage on which the audio output signals are centered. This voltage reference is half of the amplifier power supply to allow symmetrical swing of the output voltages. Do not connect the shield to any GND reference or large currents will result. The scenario can happen if, for example, an accessory other than a floating GND headphone is plugged into the headphone connector. See the second block diagram and waveform in [Figure 36](#).

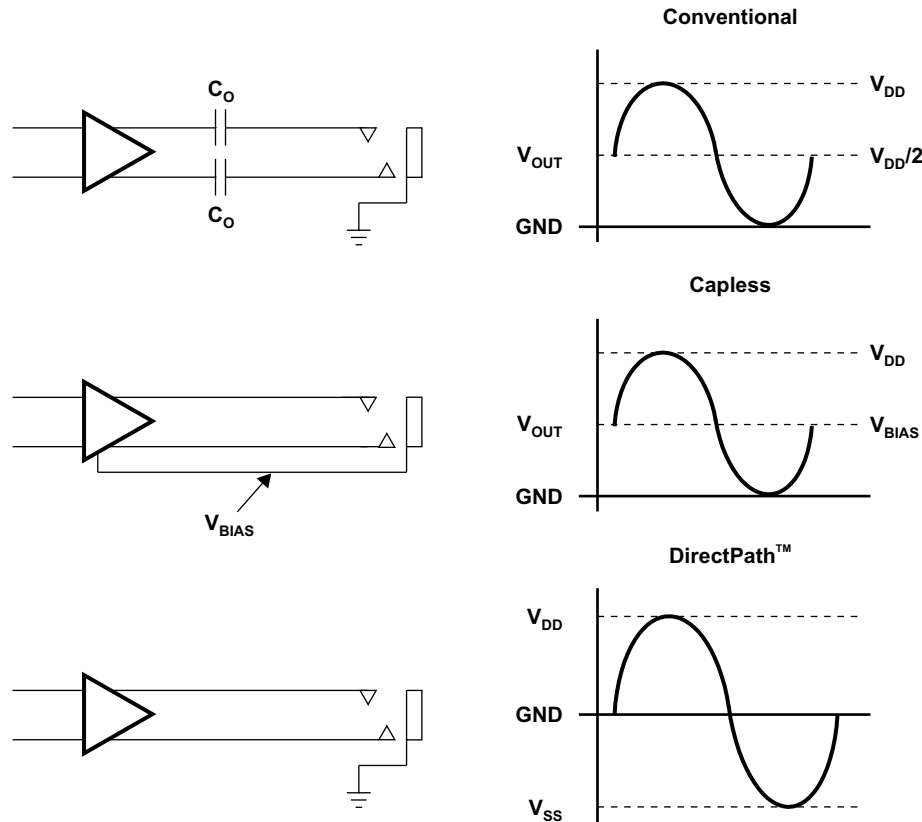

**Figure 36. Amplifier Applications**

The DirectPath™ amplifier architecture operates from a single supply but makes use of an internal charge pump to provide a negative voltage rail. Combining the user provided positive rail and the negative rail generated by the IC, the device operates in what is effectively a split supply mode. The output voltages are now centered at zero volts with the capability to swing to the positive rail or negative rail. The DirectPath™ amplifier requires no output dc blocking capacitors, and does not place any voltage on the sleeve. The bottom block diagram and waveform of [Figure 36](#) illustrate the ground-referenced headphone architecture. This is the architecture of the TPA6130A2.

### Input-Blocking Capacitors

DC input-blocking capacitors block the dc portion of the audio source, and allow the inputs to properly bias. Maximum performance is achieved when the inputs of the TPA6130A2 are properly biased. Performance issues such as pop are optimized with proper input capacitors.

The dc input-blocking capacitors may be removed provided the inputs are connected differentially and within the input common mode range of the amplifier, the audio signal does not exceed  $\pm 3$  V, and pop performance is sufficient.

$C_{IN}$  is a theoretical capacitor used for mathematical calculations only. Its value is the series combination of the dc input-blocking capacitors,  $C_{(DCINPUT-BLOCKING)}$ . Use Equation 3 to determine the value of  $C_{(DCINPUT-BLOCKING)}$ . For example, if  $C_{IN}$  is equal to 0.22  $\mu\text{F}$ , then  $C_{(DCINPUT-BLOCKING)}$  is equal to about 0.47  $\mu\text{F}$ .

$$C_{IN} = \frac{1}{2} C_{(DCINPUT-BLOCKING)} \quad (3)$$

The two  $C_{(DCINPUT-BLOCKING)}$  capacitors form a high-pass filter with the input impedance of the TPA6130A2. Use Equation 3 to calculate  $C_{IN}$ , then calculate the cutoff frequency using  $C_{IN}$  and the differential input impedance of the TPA6130A2,  $R_{IN}$ , using Equation 4. Note that the differential input impedance changes with gain. See Figure 33 for input impedance values. The frequency and/or capacitance can be determined when one of the two values are given.

$$f_{C_{IN}} = \frac{1}{2\pi R_{IN} C_{IN}} \quad \text{or} \quad C_{IN} = \frac{1}{2\pi f_{C_{IN}} R_{IN}} \quad (4)$$

If a high pass filter with a -3 dB point of no more than 20 Hz is desired over all gain settings, the minimum impedance would be used in the above equation. Figure 33 shows this to be 37 k $\Omega$ . The capacitor value by the above equation would be 0.215  $\mu\text{F}$ . However, this is  $C_{IN}$ , and the desired value is for  $C_{(DCINPUT-BLOCKING)}$ . Multiplying  $C_{IN}$  by 2 yields 0.43  $\mu\text{F}$ , which is close to the standard capacitor value of 0.47  $\mu\text{F}$ . Place 0.47  $\mu\text{F}$  capacitors at each input terminal of the TPA6130A2 to complete the filter.

### Charge Pump Flying Capacitor and CPVSS Capacitor

The charge pump flying capacitor serves to transfer charge during the generation of the negative supply voltage. The  $CP_{VSS}$  capacitor must be at least equal to the flying capacitor in order to allow maximum charge transfer. Low ESR capacitors are an ideal selection, and a value of 1  $\mu\text{F}$  is typical.

### Decoupling Capacitors

The TPA6130A2 is a DirectPath™ headphone amplifier that requires adequate power supply decoupling to ensure that the noise and total harmonic distortion (THD) are low. Use good low equivalent-series-resistance (ESR) ceramic capacitors, typically 1.0  $\mu\text{F}$ . Find the smallest package possible, and place as close as possible to the device  $V_{DD}$  lead. Placing the decoupling capacitors close to the TPA6130A2 is important for the performance of the amplifier. Use a 10  $\mu\text{F}$  or greater capacitor near the TPA6130A2 to filter lower frequency noise signals. The high PSRR of the TPA6130A2 will make the 10  $\mu\text{F}$  capacitor unnecessary in most applications.

### Layout Recommendations

#### Exposed Pad On TPA6130A2RTJ Package Option

Solder the exposed metal pad on the TPA6130A2RTJ QFN package to the a pad on the PCB. *The pad on the PCB may be grounded or may be allowed to float (not be connected to ground or power).* If the pad is grounded, it must be connected to the same ground as the GND pins (3, 9, 10, 13, and 19). See the layout and mechanical drawings at the end of the datasheet for proper sizing. Soldering the thermal pad improves mechanical reliability, improves grounding of the device, and enhances thermal conductivity of the package.

#### GND Connections

The GND pin for charge pump should be decoupled to the charge pump  $V_{DD}$  pin, and the GND pin adjacent to the Analog  $V_{DD}$  pin should be separately decoupled to each other.

## I<sup>2</sup>C CONTROL INTERFACE DETAILS

### Addressing the TPA6130A2

The device operates only as a slave device whose address is 1100000 binary.

## GENERAL I<sup>2</sup>C OPERATION

The I<sup>2</sup>C bus employs two signals; SDA (data) and SCL (clock), to communicate between integrated circuits in a system. Data is transferred on the bus serially, one bit at a time. The address and data are transferred in byte (8-bit) format with the most-significant bit (MSB) transferred first. In addition, each byte transferred on the bus is acknowledged by the receiving device with an acknowledge bit. Each transfer operation begins with the master device driving a start condition on the bus and ends with the master device driving a stop condition on the bus. The bus uses transitions on the data terminal (SDA) while the clock is high to indicate start and stop conditions. A high-to-low transition on SDA indicates a start and a low-to-high transition indicates a stop. Normal data-bit transitions must occur within the low time of the clock period. These conditions are shown in Figure 37. The master generates the 7-bit slave address and the read/write (R/W) bit to open communication with another device and then wait for an acknowledge condition. The TPA6130A2 holds SDA low during acknowledge clock period to indicate an acknowledgment. When this occurs, the master transmits the next byte of the sequence. Each device is addressed by a unique 7-bit slave address plus R/W bit (1 byte). All compatible devices share the same signals via a bidirectional bus using a wired-AND connection.

An external pull-up resistor must be used for the SDA and SCL signals to set the HIGH level for the bus. When the bus level is 5 V, pull-up resistors between 1 k $\Omega$  and 2 k $\Omega$  in value must be used.

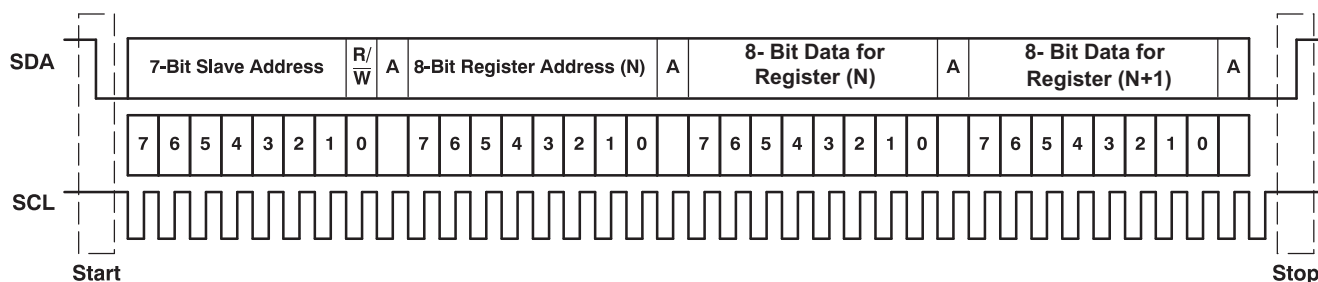

Figure 37. Typical I<sup>2</sup>C Sequence

There is no limit on the number of bytes that can be transmitted between start and stop conditions. When the last word transfers, the master generates a stop condition to release the bus. A generic data transfer sequence is shown in Figure 37.

## SINGLE-AND MULTIPLE-BYTE TRANSFERS

The serial control interface supports both single-byte and multi-byte read/write operations for all registers.

During multiple-byte read operations, the TPA6130A2 responds with data, a byte at a time, starting at the register assigned, as long as the master device continues to respond with acknowledges.

The TPA6130A2 supports sequential I<sup>2</sup>C addressing. For write transactions, if a register is issued followed by data for that register and all the remaining registers that follow, a sequential I<sup>2</sup>C write transaction has taken place. For I<sup>2</sup>C sequential write transactions, the register issued then serves as the starting point, and the amount of data subsequently transmitted, before a stop or start is transmitted, determines to how many registers are written.

## SINGLE-BYTE WRITE

As shown in Figure 38, a single-byte data write transfer begins with the master device transmitting a start condition followed by the I<sup>2</sup>C device address and the read/write bit. The read/write bit determines the direction of the data transfer. For a write data transfer, the read/write bit must be set to 0. After receiving the correct I<sup>2</sup>C device address and the read/write bit, the TPA6130A2 responds with an acknowledge bit. Next, the master transmits the register byte corresponding to the TPA6130A2 internal memory address being accessed. After receiving the register byte, the TPA6130A2 again responds with an acknowledge bit. Next, the master device transmits the data byte to be written to the memory address being accessed. After receiving the data byte, the TPA6130A2 again responds with an acknowledge bit. Finally, the master device transmits a stop condition to complete the single-byte data write transfer.

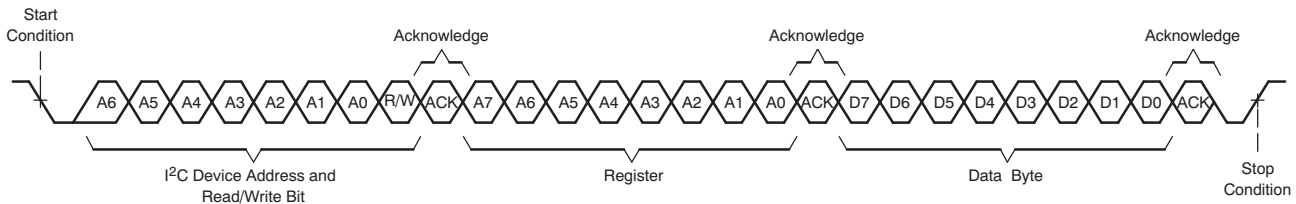

Figure 38. Single-Byte Write Transfer

**MULTIPLE-BYTE WRITE AND INCREMENTAL MULTIPLE-BYTE WRITE**

A multiple-byte data write transfer is identical to a single-byte data write transfer except that multiple data bytes are transmitted by the master device to the TPA6130A2 as shown in Figure 39. After receiving each data byte, the TPA6130A2 responds with an acknowledge bit.

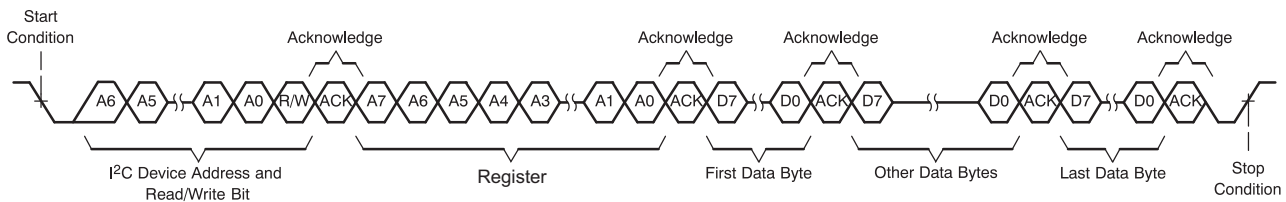

Figure 39. Multiple-Byte Write Transfer

**SINGLE-BYTE READ**

As shown in Figure 40, a single-byte data read transfer begins with the master device transmitting a start condition followed by the I²C device address and the read/write bit. For the data read transfer, both a write followed by a read are actually done. Initially, a write is done to transfer the address byte of the internal memory address to be read. As a result, the read/write bit is set to a 0.

After receiving the TPA6130A2 address and the read/write bit, the TPA6130A2 responds with an acknowledge bit. The master then sends the internal memory address byte, after which the TPA6130A2 issues an acknowledge bit. The master device transmits another start condition followed by the TPA6130A2 address and the read/write bit again. This time the read/write bit is set to 1, indicating a read transfer. Next, the TPA6130A2 transmits the data byte from the memory address being read. After receiving the data byte, the master device transmits a not-acknowledge followed by a stop condition to complete the single-byte data read transfer.

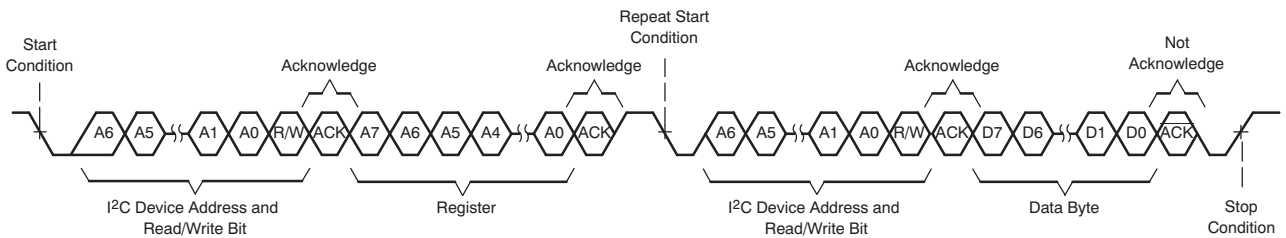
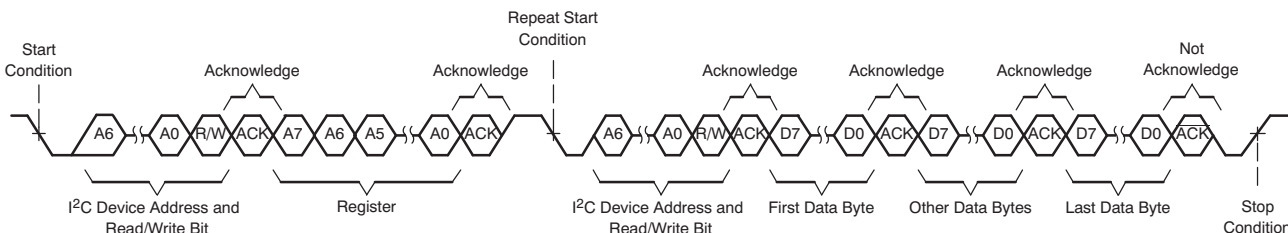

Figure 40. Single-Byte Read Transfer

**MULTIPLE-BYTE READ**

A multiple-byte data read transfer is identical to a single-byte data read transfer except that multiple data bytes are transmitted by the TPA6130A2 to the master device as shown in Figure 41. With the exception of the last data byte, the master device responds with an acknowledge bit after receiving each data byte.





**Figure 41. Multiple-Byte Read Transfer**

## Register Map

**Table 1. Register Map**

Register	Bit7	Bit6	Bit5	Bit4	Bit3	Bit2	Bit1	Bit0
1	HP_EN_L	HP_EN_R	Mode[1]	Mode[0]	Reserved	Reserved	Thermal	SWS
2	Mute_L	Mute_R	Volume[5]	Volume[4]	Volume[3]	Volume[2]	Volume[1]	Volume[0]
3	Reserved	Reserved	Reserved	Reserved	Reserved	Reserved	HiZ_L	HiZ_R
4	Reserved	Reserved	RFT	RFT	Version[3]	Version[2]	Version[1]	Version[0]
5	RFT	RFT	RFT	RFT	RFT	RFT	RFT	RFT
6	RFT	RFT	RFT	RFT	RFT	RFT	RFT	RFT
7	RFT	RFT	RFT	RFT	RFT	RFT	RFT	RFT
8	RFT	RFT	RFT	RFT	RFT	RFT	RFT	RFT

Bits labeled "Reserved" are reserved for future enhancements. They may not be written to. When read, they will show a "0" value.

Bits labeled "RFT" are reserved for TI testing. Under no circumstances must any data be written to these registers. Writing to these bits may change the function of the device, or cause complete failure. If read, these bits may assume any value.

### Control Register (Address: 1)

BIT	7	6	5	4	3	2	1	0
Function	HP_EN_L	HP_EN_R	Mode[1]	Mode[0]	Reserved	Reserved	Thermal	SWS
Reset Value	0	0	0	0	0	0	0	0

**HP\_EN\_L** Enable bit for the left-channel amplifier. Amplifier is active when bit is high.

**HP\_EN\_R** Enable bit for the right-channel amplifier. Amplifier is active when bit is high.

**Mode[1:0]** Mode bits Mode[1] and Mode[0] select one of three modes of operation. 00 is stereo headphone mode. 01 is dual mono headphone mode. 10 is bridge-tied load mode.

**Reserved** These bits are reserved for future enhancements. They may not be written to. When read they will read as zero.

**Thermal** A 1 on this bit indicates a thermal shutdown was initiated by the hardware. When the temperature drops to safe levels, the device will start to operate again, regardless of bit status. This bit is clear-on-read.

**SWS** Software shutdown control. When the bit is one, the device is in software shutdown. When the bit is low, the charge-pump is active. SWS must be low for normal operation.

**Volume and Mute Register (Address: 2)**

BIT	7	6	5	4	3	2	1	0
Function	Mute_L	Mute_R	Volume[5]	Volume[4]	Volume[3]	Volume[2]	Volume[1]	Volume[0]
Reset Value	1	1	0	0	0	0	0	0

Mute\_L Left channel mute. If this bit is High the left channel is muted.

Mute\_R Right channel mute. If this bit is High the right channel is muted.

Volume[5:0] Six bits for volume control. 111111 indicates the highest gain and 000000 indicates the lowest gain.

**Output Impedance Register (Address: 3)**

BIT	7	6	5	4	3	2	1	0
Function	Reserved	Reserved	Reserved	Reserved	Reserved	Reserved	HiZ_L	HiZ_R
Reset Value	0	0	0	0	0	0	0	0

Reserved These bits are reserved for future enhancements. They may not be written to. When read they will read as zero. All writes to these bits will be ignored.

HiZ\_L Puts left-channel amplifier output in tri-state high impedance mode.

HiZ\_R Puts right-channel amplifier output in tri-state high impedance mode.

**I<sup>2</sup>C address and Version Register (Address: 4)**

BIT	7	6	5	4	3	2	1	0
Function	Reserved	Reserved	RFT	RFT	Version[3]	Version[2]	Version[1]	Version[0]
Reset Value	0	0	0	0	0	0	0	0

Reserved These bits are reserved for future enhancements. They may not be written to. When read they will read as zero.

Version[3:0] The version bits track the revision of the silicon. Valid values are 0010 for released TPA6130A2.

RFT Reserved for Test. Do NOT write to these registers.

**Reserved for test registers (Addresses: 5-8)**

BIT	7	6	5	4	3	2	1	0
Function	RFT	RFT	RFT	RFT	RFT	RFT	RFT	RFT
Reset Value	x	x	x	x	x	x	x	x

RFT Reserved for Test. Do NOT write to these registers.

## Modes of Operation

The TPA6130A2 supports numerous modes of operation.

### Hardware Shutdown

Hardware shutdown occurs when the  $\overline{SD}$  pin is set to logic 0. The device is completely shutdown in this mode, drawing minimal current. This mode overrides all other modes. All information programmed into the registers is lost. When the device starts up again, the registers go back to their default state.

### Software Shutdown

Software shutdown is set by placing a logic 1 in register 1, bit 0. That is the SWS bit. The software shutdown places the device in a low power state, although the current draw is higher than that of hardware shutdown (see the Electrical Characteristics Table for values). Engaging software shutdown turns off the charge pump and disables the outputs. The device is awakened by placing a logic 0 in the SWS bit.

Note that when the device is in SWS mode, register 1, bits 7 and 6 will be cleared to reflect the disabled state of the amplifier. All other registers maintain their values. Re-enable the amplifier by placing a logic 0 in the SWS bit. It is necessary to reset the entire register because a full word must be used when writing just one bit.

### Charge Pump Enabled, HP Amplifiers Disabled

The output amplifiers of the TPA6130A2 are enabled by placing a logic 1 in register 1, bits 6 and 7. Place a logic 0 in register 1, bits 6 and 7 to disable the output amplifiers. The left and right outputs can be enabled and disabled individually. When the output amplifiers are disabled, the charge-pump remains on.

### HiZ State

HiZ is enabled by placing a logic 1 in register 3, bits 0 and 1. Place a logic 0 in register 3, bits 0 and 1 to disable the HiZ state of the outputs. The left and right outputs can be placed into a HiZ state individually.

The HiZ state puts the outputs into a state of high impedance. Use this configuration when the outputs of the TPA6130A2 share traces with other devices whose outputs may be active.

Note that to use the HiZ mode, the TPA6130A2 MUST be active (not in SWS or hardware shutdown). Furthermore, the output amplifiers must NOT be enabled.

### Stereo Headphone Drive

The device is in this mode when the MODE bits in register 1 are 00 and both headphone enable bits are enabled. The two amplifier channels operate independently. This mode is appropriate for stereo playback.

### Dual Mono Headphone Drive

The device is in this mode when the MODE bits in register 1 are 01 and both headphone enable bits are enabled. The left channel is the active input. It is amplified and distributed to both the left and right headphone outputs.

### Bridge-Tied Load Receiver Drive

The device is in this mode when the MODE bits in register 1 are 10 and both headphone enable bits are enabled. In this mode, the device will take the left channel input and drive a single load connected between HPLEFT and HPRIGHT in a bridge-tied fashion. The minimum load for bridge-tied mode is the same as for stereo mode (see table entitled "Absolute Maximum Ratings").

### Default Mode

The TPA6130A2 starts up with the following conditions:

- SWS = Off, CHARGE PUMP = On
- HP ENABLES = Off
- HiZ = Off
- MODE = Stereo
- HP MUTES = On, VOLUME = -59.5 dB,

### VOLUME CONTROL

The TPA6130A2 volume control is set through the I<sup>2</sup>C interface. The six volume control register bits are decoded to 64 volume settings that employ an audio taper. See [Table 2](#) for the gain table. The values listed in this table are typical. Each gain step has a different input impedance. See [Figure 33](#).

**Table 2. Audio Taper Gain Values**

Gain Control Word (Binary) Mute [7:6], V[5:0]	Nominal Gain (dB)	Nominal Gain (V/V)	Gain Control Word (Binary) Mute [7:6], V[5:0]	Nominal Gain (dB)	Nominal Gain (V/V)
11XXXXXX	-100	0.00001	00100000	-10.9	0.283
00000000	-59.5	0.001	00100001	-10.3	0.305
00000001	-53.5	0.002	00100010	-9.7	0.329
00000010	-50.0	0.003	00100011	-9.0	0.353
00000011	-47.5	0.004	00100100	-8.5	0.379
00000100	-45.5	0.005	00100101	-7.8	0.405
00000101	-43.9	0.007	00100110	-7.2	0.433
00000110	-41.4	0.009	00100111	-6.7	0.462
00000111	-39.5	0.012	00101000	-6.1	0.493
00001000	-36.5	0.015	00101001	-5.6	0.524
00001001	-35.3	0.018	00101010	-5.1	0.557
00001010	-33.3	0.022	00101011	-4.5	0.591
00001011	-31.7	0.026	00101100	-4.1	0.627
00001100	-30.4	0.031	00101101	-3.5	0.664
00001101	-28.6	0.037	00101110	-3.1	0.702
00001110	-27.1	0.043	00101111	-2.6	0.742
00001111	-26.3	0.050	00110000	-2.1	0.783
00010000	-24.7	0.057	00110001	-1.7	0.825
00010001	-23.7	0.065	00110010	-1.2	0.870
00010010	-22.5	0.074	00110011	-0.8	0.915
00010011	-21.7	0.084	00110100	-0.3	0.962
00010100	-20.5	0.093	00110101	0.1	1.010
00010101	-19.6	0.104	00110110	0.5	1.061
00010110	-18.8	0.116	00110111	0.9	1.112
00010111	-17.8	0.129	00111000	1.4	1.165
00011000	-17.0	0.142	00111001	1.7	1.220
00011001	-16.2	0.156	00111010	2.1	1.277
00011010	-15.2	0.172	00111011	2.5	1.335
00011011	-14.5	0.188	00111100	2.9	1.395
00011100	-13.7	0.205	00111101	3.3	1.456
00011101	-13.0	0.223	00111110	3.6	1.520
00011110	-12.3	0.242	00111111	4.0	1.585
00011111	-11.6	0.262			

**PACKAGING INFORMATION**

Orderable Device	Status <sup>(1)</sup>	Package Type	Package Drawing	Pins	Package Qty	Eco Plan <sup>(2)</sup>	Lead/Ball Finish	MSL Peak Temp <sup>(3)</sup>
TPA6130A2RTJR	ACTIVE	QFN	RTJ	20	3000	Green (RoHS & no Sb/Br)	CU NIPDAU	Level-2-260C-1 YEAR
TPA6130A2RTJRG4	ACTIVE	QFN	RTJ	20	3000	Green (RoHS & no Sb/Br)	CU NIPDAU	Level-2-260C-1 YEAR
TPA6130A2RTJT	ACTIVE	QFN	RTJ	20	250	Green (RoHS & no Sb/Br)	CU NIPDAU	Level-2-260C-1 YEAR
TPA6130A2RTJTG4	ACTIVE	QFN	RTJ	20	250	Green (RoHS & no Sb/Br)	CU NIPDAU	Level-2-260C-1 YEAR
TPA6130A2YZHR	ACTIVE	DSBGA	YZH	16	3000	Green (RoHS & no Sb/Br)	SNAGCU	Level-1-260C-UNLIM
TPA6130A2YZHT	ACTIVE	DSBGA	YZH	16	250	Green (RoHS & no Sb/Br)	SNAGCU	Level-1-260C-UNLIM

<sup>(1)</sup> The marketing status values are defined as follows:

**ACTIVE:** Product device recommended for new designs.

**LIFEBUY:** TI has announced that the device will be discontinued, and a lifetime-buy period is in effect.

**NRND:** Not recommended for new designs. Device is in production to support existing customers, but TI does not recommend using this part in a new design.

**PREVIEW:** Device has been announced but is not in production. Samples may or may not be available.

**OBSOLETE:** TI has discontinued the production of the device.

<sup>(2)</sup> Eco Plan - The planned eco-friendly classification: Pb-Free (RoHS), Pb-Free (RoHS Exempt), or Green (RoHS & no Sb/Br) - please check <http://www.ti.com/productcontent> for the latest availability information and additional product content details.

**TBD:** The Pb-Free/Green conversion plan has not been defined.

**Pb-Free (RoHS):** TI's terms "Lead-Free" or "Pb-Free" mean semiconductor products that are compatible with the current RoHS requirements for all 6 substances, including the requirement that lead not exceed 0.1% by weight in homogeneous materials. Where designed to be soldered at high temperatures, TI Pb-Free products are suitable for use in specified lead-free processes.

**Pb-Free (RoHS Exempt):** This component has a RoHS exemption for either 1) lead-based flip-chip solder bumps used between the die and package, or 2) lead-based die adhesive used between the die and leadframe. The component is otherwise considered Pb-Free (RoHS compatible) as defined above.

**Green (RoHS & no Sb/Br):** TI defines "Green" to mean Pb-Free (RoHS compatible), and free of Bromine (Br) and Antimony (Sb) based flame retardants (Br or Sb do not exceed 0.1% by weight in homogeneous material)

<sup>(3)</sup> MSL, Peak Temp. -- The Moisture Sensitivity Level rating according to the JEDEC industry standard classifications, and peak solder temperature.

**Important Information and Disclaimer:** The information provided on this page represents TI's knowledge and belief as of the date that it is provided. TI bases its knowledge and belief on information provided by third parties, and makes no representation or warranty as to the accuracy of such information. Efforts are underway to better integrate information from third parties. TI has taken and continues to take reasonable steps to provide representative and accurate information but may not have conducted destructive testing or chemical analysis on incoming materials and chemicals. TI and TI suppliers consider certain information to be proprietary, and thus CAS numbers and other limited information may not be available for release.

In no event shall TI's liability arising out of such information exceed the total purchase price of the TI part(s) at issue in this document sold by TI to Customer on an annual basis.

**TAPE AND REEL INFORMATION**

**QUADRANT ASSIGNMENTS FOR PIN 1 ORIENTATION IN TAPE**

\*All dimensions are nominal

Device	Package Type	Package Drawing	Pins	SPQ	Reel Diameter (mm)	Reel Width W1 (mm)	A0 (mm)	B0 (mm)	K0 (mm)	P1 (mm)	W (mm)	Pin1 Quadrant
TPA6130A2RTJR	QFN	RTJ	20	3000	330.0	12.4	4.25	4.25	1.15	8.0	12.0	Q2
TPA6130A2RTJT	QFN	RTJ	20	250	180.0	12.4	4.25	4.25	1.15	8.0	12.0	Q2
TPA6130A2YZHR	DSBGA	YZH	16	3000	180.0	8.4	2.07	2.07	0.81	4.0	8.0	Q1
TPA6130A2YZHR	DSBGA	YZH	16	3000	180.0	8.4	2.07	2.07	0.81	4.0	8.0	Q1
TPA6130A2YZHT	DSBGA	YZH	16	250	180.0	8.4	2.07	2.07	0.81	4.0	8.0	Q1
TPA6130A2YZHT	DSBGA	YZH	16	250	180.0	8.4	2.07	2.07	0.81	4.0	8.0	Q1

**TAPE AND REEL BOX DIMENSIONS**



\*All dimensions are nominal

Device	Package Type	Package Drawing	Pins	SPQ	Length (mm)	Width (mm)	Height (mm)
TPA6130A2RTJR	QFN	RTJ	20	3000	346.0	346.0	29.0
TPA6130A2RTJT	QFN	RTJ	20	250	190.5	212.7	31.8
TPA6130A2YZHR	DSBGA	YZH	16	3000	220.0	220.0	34.0
TPA6130A2YZHR	DSBGA	YZH	16	3000	190.5	212.7	31.8
TPA6130A2YZHT	DSBGA	YZH	16	250	220.0	220.0	34.0
TPA6130A2YZHT	DSBGA	YZH	16	250	190.5	212.7	31.8

# MECHANICAL DATA

RTJ (S-PWQFN-N20)

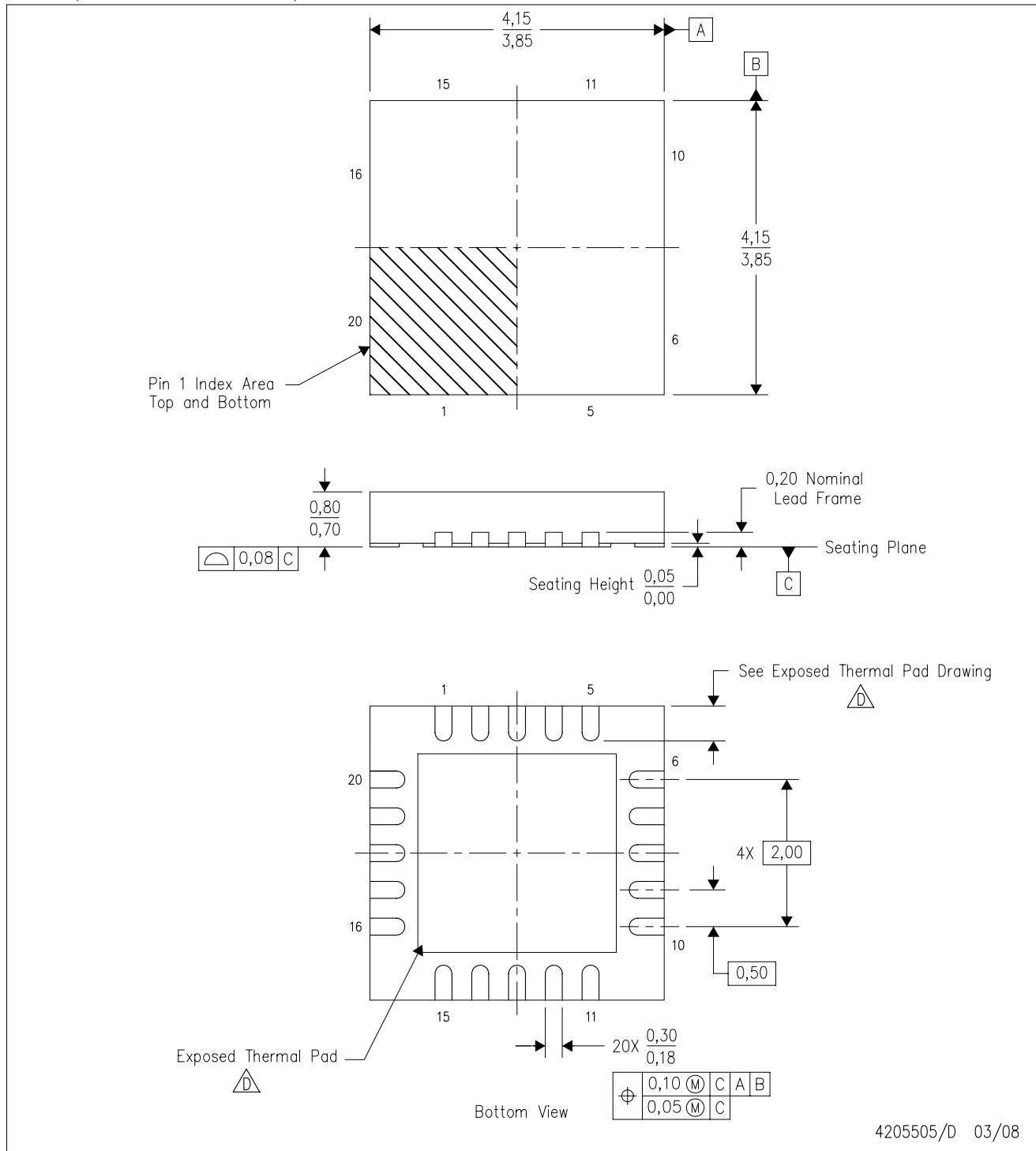
PLASTIC QUAD FLATPACK NO-LEAD



4205505/D 03/08

- NOTES:
- A. All linear dimensions are in millimeters. Dimensioning and tolerancing per ASME Y14.5-1994.
  - B. This drawing is subject to change without notice.
  - C. QFN (Quad Flatpack No-Lead) package configuration.
  - D. The package thermal pad must be soldered to the board for thermal and mechanical performance. See the Product Data Sheet for details regarding the exposed thermal pad dimensions.



## THERMAL PAD MECHANICAL DATA

RTJ (S-PWQFN-N20)

PLASTIC QUAD FLATPACK NO-LEAD

### THERMAL INFORMATION

This package incorporates an exposed thermal pad that is designed to be attached directly to an external heatsink. The thermal pad must be soldered directly to the printed circuit board (PCB). After soldering, the PCB can be used as a heatsink. In addition, through the use of thermal vias, the thermal pad can be attached directly to the appropriate copper plane shown in the electrical schematic for the device, or alternatively, can be attached to a special heatsink structure designed into the PCB. This design optimizes the heat transfer from the integrated circuit (IC).

For information on the Quad Flatpack No-Lead (QFN) package and its advantages, refer to Application Report, QFN/SON PCB Attachment, Texas Instruments Literature No. SLUA271. This document is available at [www.ti.com](http://www.ti.com).

The exposed thermal pad dimensions for this package are shown in the following illustration.

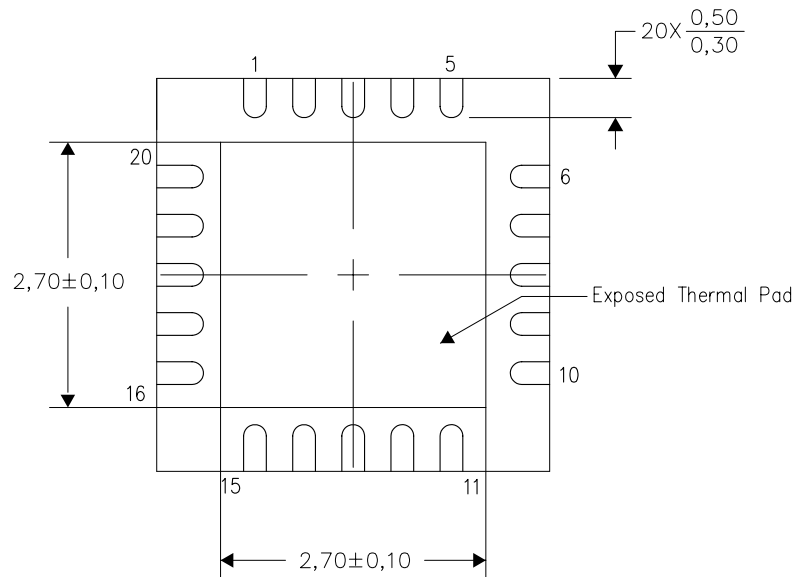

Bottom View

NOTE: All linear dimensions are in millimeters

Exposed Thermal Pad Dimensions

4206256-2/L 07/10

RTJ (S-PWQFN-N20)

PLASTIC QUAD FLATPACK NO-LEAD

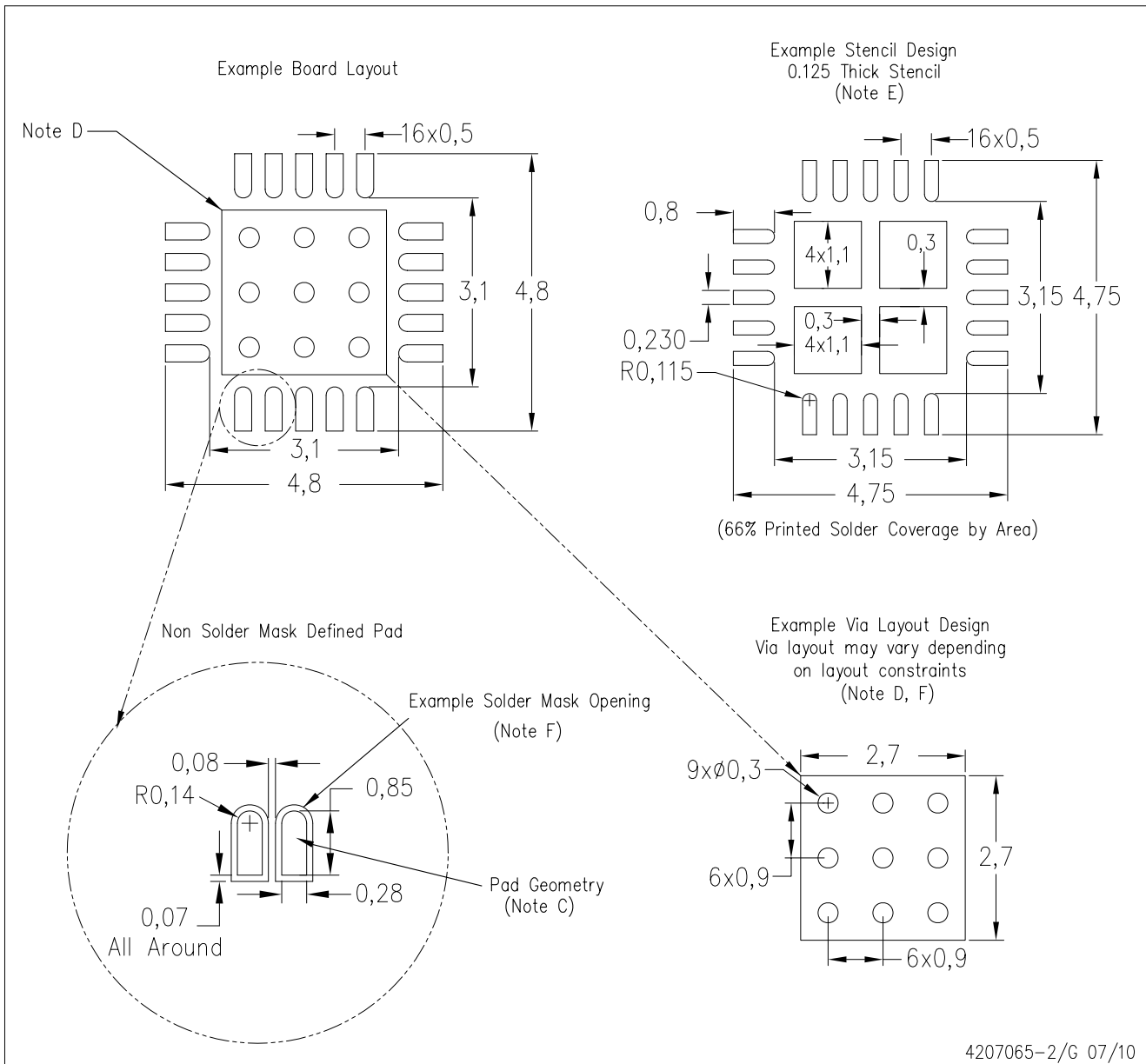

- NOTES:
- All linear dimensions are in millimeters.
  - This drawing is subject to change without notice.
  - Publication IPC-7351 is recommended for alternate designs.
  - This package is designed to be soldered to a thermal pad on the board. Refer to Application Note, Quad Flat-Pack Packages, Texas Instruments Literature No. SLUA271, and also the Product Data Sheets for specific thermal information, via requirements, and recommended board layout. These documents are available at [www.ti.com](http://www.ti.com) <<http://www.ti.com>>.
  - Laser cutting apertures with trapezoidal walls and also rounding corners will offer better paste release. Customers should contact their board assembly site for stencil design recommendations. Refer to IPC 7525 for stencil design considerations.
  - Customers should contact their board fabrication site for recommended solder mask tolerances and via tenting recommendations for vias placed in the thermal pad.

YZH (S-XBGA-N16)

DIE-SIZE BALL GRID ARRAY

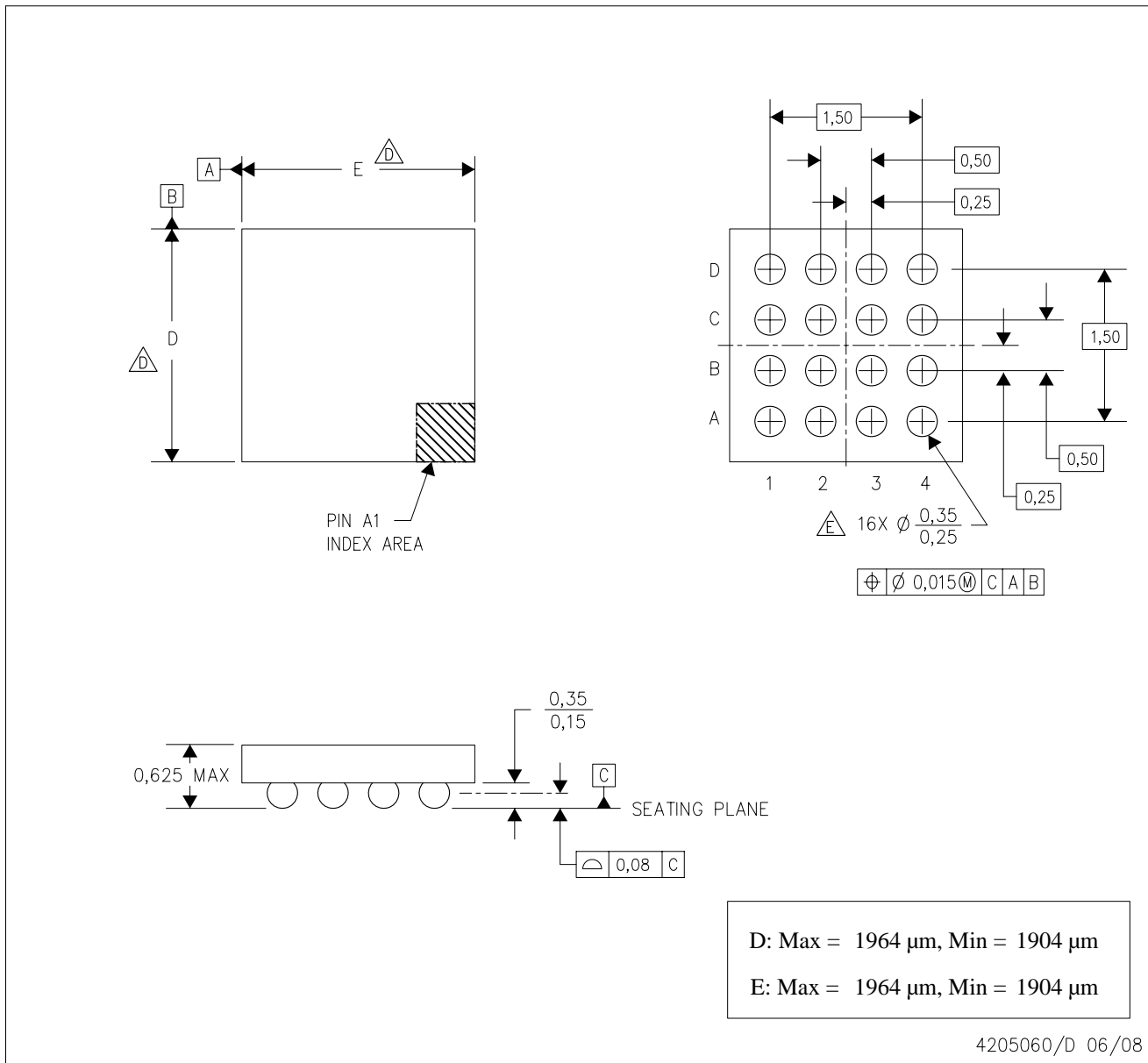

- NOTES:
- A. All linear dimensions are in millimeters.
  - B. This drawing is subject to change without notice.
  - C. NanoFree™ package configuration.
  - $\triangle D$  Devices in YZH package can have dimension D ranging from 1.94 to 2.65 mm and dimension E ranging from 1.94 to 2.65 mm. To determine the exact package size of a particular device, refer to the device datasheet or contact a local TI representative.
  - E. Reference Product Data Sheet for array population.  
4 x 4 matrix pattern is shown for illustration only.
  - F. This package contains lead-free balls.  
Refer to YEH (Drawing #4204183) for tin-lead (SnPb) balls.

NanoFree is a trademark of Texas Instruments.

## IMPORTANT NOTICE

Texas Instruments Incorporated and its subsidiaries (TI) reserve the right to make corrections, modifications, enhancements, improvements, and other changes to its products and services at any time and to discontinue any product or service without notice. Customers should obtain the latest relevant information before placing orders and should verify that such information is current and complete. All products are sold subject to TI's terms and conditions of sale supplied at the time of order acknowledgment.

TI warrants performance of its hardware products to the specifications applicable at the time of sale in accordance with TI's standard warranty. Testing and other quality control techniques are used to the extent TI deems necessary to support this warranty. Except where mandated by government requirements, testing of all parameters of each product is not necessarily performed.

TI assumes no liability for applications assistance or customer product design. Customers are responsible for their products and applications using TI components. To minimize the risks associated with customer products and applications, customers should provide adequate design and operating safeguards.

TI does not warrant or represent that any license, either express or implied, is granted under any TI patent right, copyright, mask work right, or other TI intellectual property right relating to any combination, machine, or process in which TI products or services are used. Information published by TI regarding third-party products or services does not constitute a license from TI to use such products or services or a warranty or endorsement thereof. Use of such information may require a license from a third party under the patents or other intellectual property of the third party, or a license from TI under the patents or other intellectual property of TI.

Reproduction of TI information in TI data books or data sheets is permissible only if reproduction is without alteration and is accompanied by all associated warranties, conditions, limitations, and notices. Reproduction of this information with alteration is an unfair and deceptive business practice. TI is not responsible or liable for such altered documentation. Information of third parties may be subject to additional restrictions.

Resale of TI products or services with statements different from or beyond the parameters stated by TI for that product or service voids all express and any implied warranties for the associated TI product or service and is an unfair and deceptive business practice. TI is not responsible or liable for any such statements.

TI products are not authorized for use in safety-critical applications (such as life support) where a failure of the TI product would reasonably be expected to cause severe personal injury or death, unless officers of the parties have executed an agreement specifically governing such use. Buyers represent that they have all necessary expertise in the safety and regulatory ramifications of their applications, and acknowledge and agree that they are solely responsible for all legal, regulatory and safety-related requirements concerning their products and any use of TI products in such safety-critical applications, notwithstanding any applications-related information or support that may be provided by TI. Further, Buyers must fully indemnify TI and its representatives against any damages arising out of the use of TI products in such safety-critical applications.

TI products are neither designed nor intended for use in military/aerospace applications or environments unless the TI products are specifically designated by TI as military-grade or "enhanced plastic." Only products designated by TI as military-grade meet military specifications. Buyers acknowledge and agree that any such use of TI products which TI has not designated as military-grade is solely at the Buyer's risk, and that they are solely responsible for compliance with all legal and regulatory requirements in connection with such use.

TI products are neither designed nor intended for use in automotive applications or environments unless the specific TI products are designated by TI as compliant with ISO/TS 16949 requirements. Buyers acknowledge and agree that, if they use any non-designated products in automotive applications, TI will not be responsible for any failure to meet such requirements.

Following are URLs where you can obtain information on other Texas Instruments products and application solutions:

<b>Products</b>		<b>Applications</b>	
Amplifiers	<a href="http://amplifier.ti.com">amplifier.ti.com</a>	Audio	<a href="http://www.ti.com/audio">www.ti.com/audio</a>
Data Converters	<a href="http://dataconverter.ti.com">dataconverter.ti.com</a>	Automotive	<a href="http://www.ti.com/automotive">www.ti.com/automotive</a>
DLP® Products	<a href="http://www.dlp.com">www.dlp.com</a>	Communications and Telecom	<a href="http://www.ti.com/communications">www.ti.com/communications</a>
DSP	<a href="http://dsp.ti.com">dsp.ti.com</a>	Computers and Peripherals	<a href="http://www.ti.com/computers">www.ti.com/computers</a>
Clocks and Timers	<a href="http://www.ti.com/clocks">www.ti.com/clocks</a>	Consumer Electronics	<a href="http://www.ti.com/consumer-apps">www.ti.com/consumer-apps</a>
Interface	<a href="http://interface.ti.com">interface.ti.com</a>	Energy	<a href="http://www.ti.com/energy">www.ti.com/energy</a>
Logic	<a href="http://logic.ti.com">logic.ti.com</a>	Industrial	<a href="http://www.ti.com/industrial">www.ti.com/industrial</a>
Power Mgmt	<a href="http://power.ti.com">power.ti.com</a>	Medical	<a href="http://www.ti.com/medical">www.ti.com/medical</a>
Microcontrollers	<a href="http://microcontroller.ti.com">microcontroller.ti.com</a>	Security	<a href="http://www.ti.com/security">www.ti.com/security</a>
RFID	<a href="http://www.ti-rfid.com">www.ti-rfid.com</a>	Space, Avionics & Defense	<a href="http://www.ti.com/space-avionics-defense">www.ti.com/space-avionics-defense</a>
RF/IF and ZigBee® Solutions	<a href="http://www.ti.com/lprf">www.ti.com/lprf</a>	Video and Imaging	<a href="http://www.ti.com/video">www.ti.com/video</a>
		Wireless	<a href="http://www.ti.com/wireless-apps">www.ti.com/wireless-apps</a>

Mailing Address: Texas Instruments, Post Office Box 655303, Dallas, Texas 75265  
Copyright © 2010, Texas Instruments Incorporated