

DESCRIPTION: DIP SOLDER FEMALE/STAMPED

SPECIFICATIONS:

MATERIALS:

SHELL: STEEL, NICKEL PLATED
 INSULATOR: UL 94V-0 RATED BLACK NYLON 9T
 CONTACTS: BRASS, GOLD PLATED
 RoHS COMPLIANT

ELECTRICALS:

CURRENT RATING: 5 AMPS
 CONTACT RESISTANCE: 15 mOHMS MAX
 INSULATOR RESISTANCE: 1000 MOHMS MIN
 VOLTAGE: 500V AC FOR 1 MINUTE
 TEMPERATURE: -50°C TO +100°C

POS.	A	B	C	D	E	F	G
09	1.213	0.984	0.642	0.756	0.311	0.109	0.496
	30.80	24.99	16.30	19.20	7.90	2.77	12.60
15	1.541	1.312	0.971	1.091	0.311	0.109	0.496
	39.14	33.32	24.65	27.70	7.90	2.77	12.60
25	2.087	1.852	1.512	1.618	0.311	0.109	0.496
	53.00	47.04	38.40	41.10	7.90	2.77	12.60
37	2.728	2.500	2.157	2.256	0.311	0.109	0.496
	69.29	63.50	54.80	57.30	7.90	2.77	12.60
50	2.638	2.406	2.055	2.169	0.429	0.109	0.602
	67.00	61.00	52.20	55.10	10.90	2.77	15.30

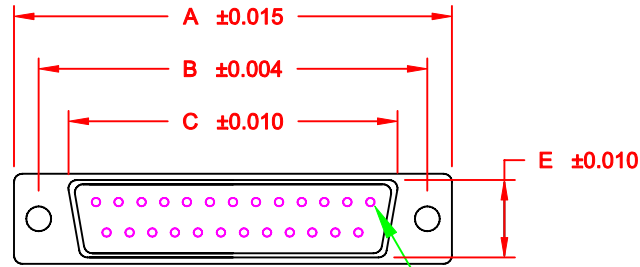

PIN #1

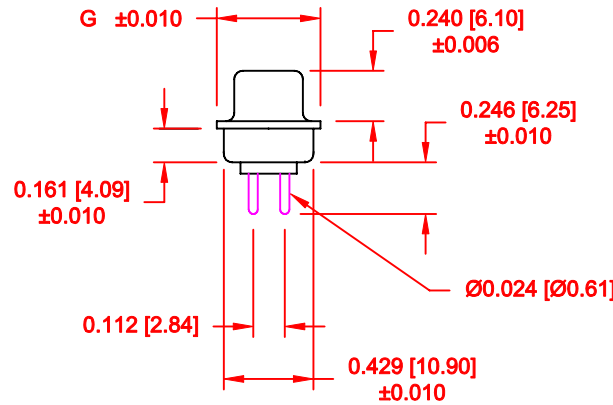
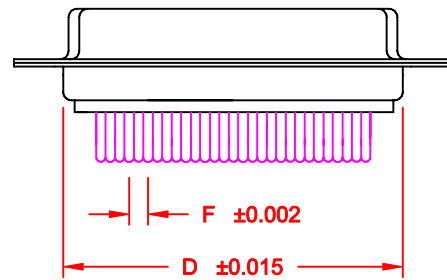

171-YYY-213RYY1

SERIES _____
 POSITIONS _____
 009 _____
 015 _____
 025 _____
 037 _____
 050 _____
 GENDER _____
 1 = MALE
 2 = FEMALE
 TERMINATION _____
 1 = DIP SOLDER
 SHELL PLATING _____
 3 = NICKEL
 HARDWARE OPTIONS _____
 00 = NO HARDWARE
 01 = .098 4-40 CLINCH NUT BOARD SIDE
 02 = .236 4-40 CLINCH NUT BOARD SIDE
 03 = .236 4-40 CLINCH NUT MATING SIDE
 05 = .237 4-40 BOARD LOCK
 91 = .237 4-40 SPACER/BOARD LOCK
 PLATING OPTIONS _____
 1 = GOLD FLASH
 2 = 30 MICRO-INCH GOLD

DO NOT SCALE FROM DRAWING

RoHS COMPLIANT

	THESE DRAWINGS AND SPECIFICATIONS ARE THE PROPERTY OF NorComp AND SHALL NOT BE REPRODUCED, COPIED OR USED AS THE BASIS FOR THE MANUFACTURE OF SALE OF APPARATUS WITHOUT WRITTEN PERMISSION.		DRAWN: PAM JENKINS	DATE: 8-12-98
			CHECKED:	DATE:
NorComp		SCALE:	SHEET 1 OF 3	REV 5
		DWG NO. 171-YYY-213RYY1		

DESCRIPTION: PCB LAYOUT - STANDARD "D" - MALE & FEMALE

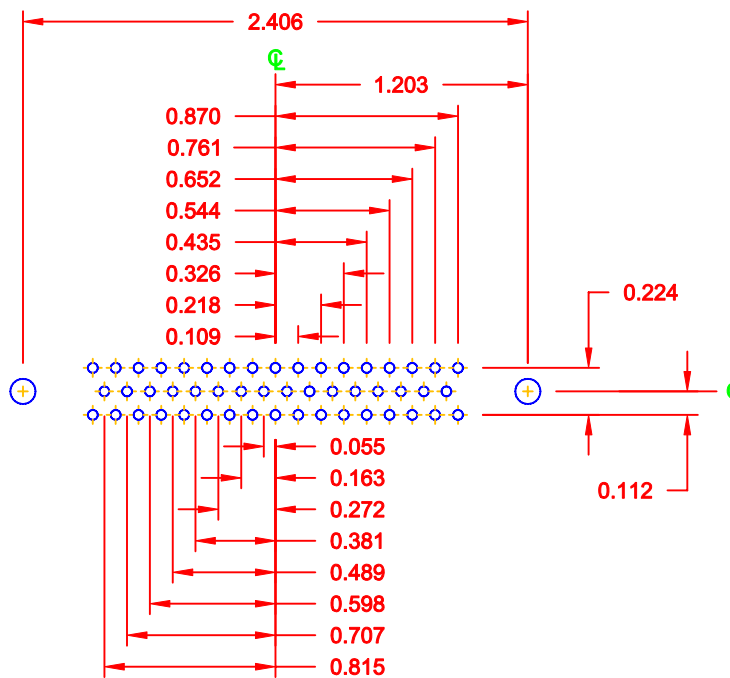
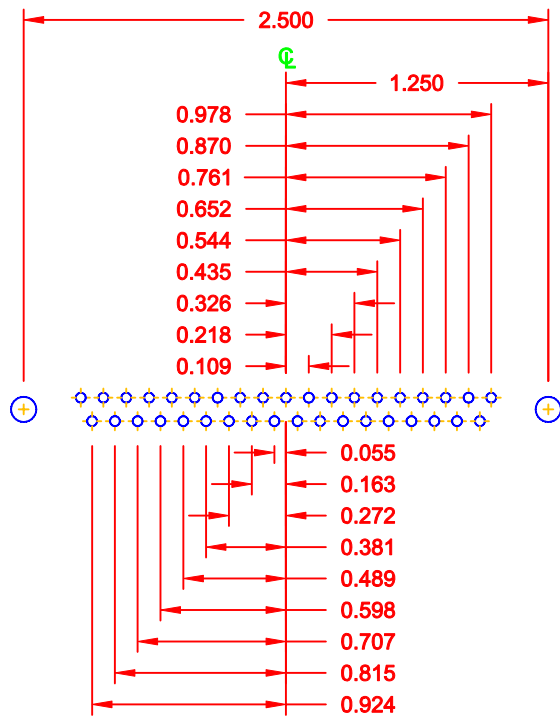
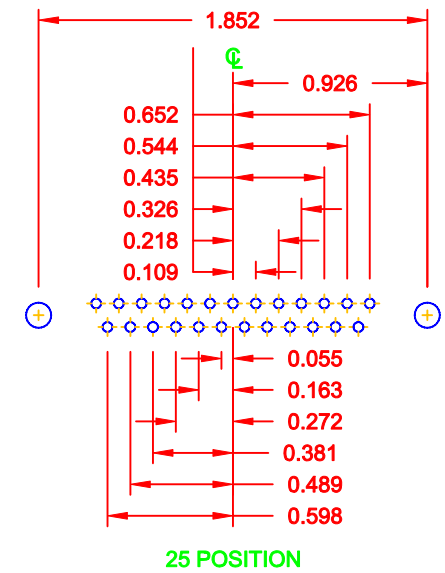
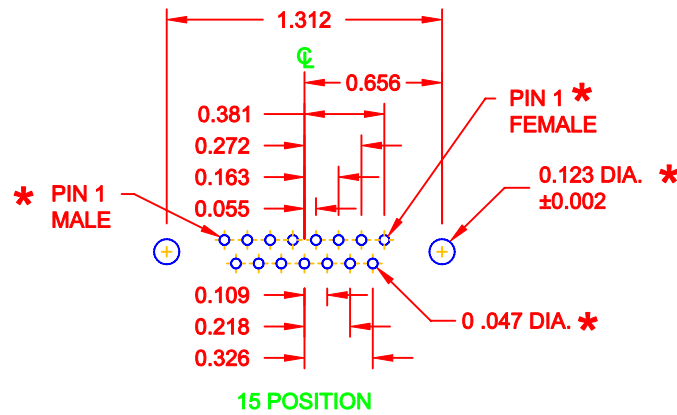
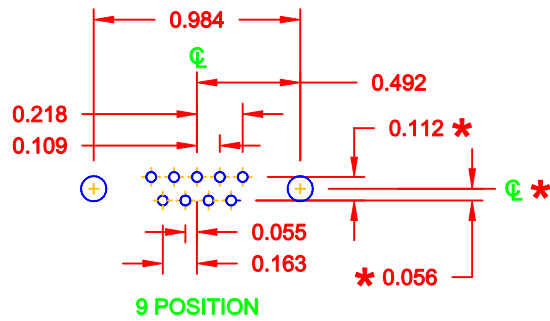

* TYP. ON ALL SIZES

DO NOT SCALE FROM DRAWING

	THESE DRAWINGS AND SPECIFICATIONS ARE THE PROPERTY OF NorComp AND SHALL NOT BE REPRODUCED, COPIED OR USED AS THE BASIS FOR THE MANUFACTURE OF SALE OF APPARATUS WITHOUT WRITTEN PERMISSION.		DRAWN: C. SMITH	DATE: 03-08-06
			CHECKED:	DATE:
NorComp	SCALE: FULL	SHEET 2 OF 3	REV 5	
	DWG NO. 171-YYY-213RYY1			

TOLERANCE:
ALL DIMENSIONS ARE ±0.010

ALL CLINCH-NUTS ARE 4-40 INTERNAL THREADS

01X 0.098" (BOARD SIDE) - CN1

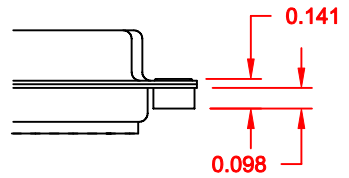

02X 0.236" (BOARD SIDE) - CN2

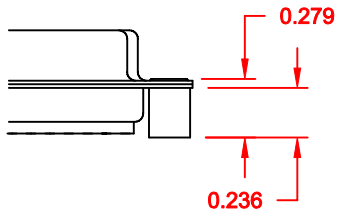

03X..... 0.236" (MATING SIDE) - CN8

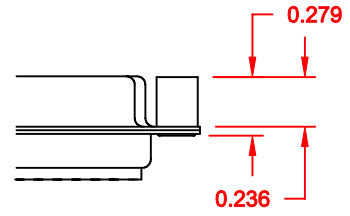

05X 0.237" (BOARD SIDE) - CN10

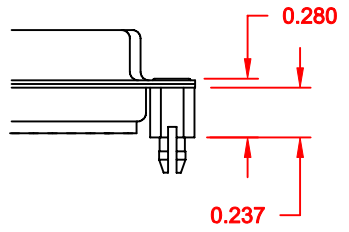

91X 0.237" BOARD SIDE
0.197 MATING SIDE
CN10/SFSO4404

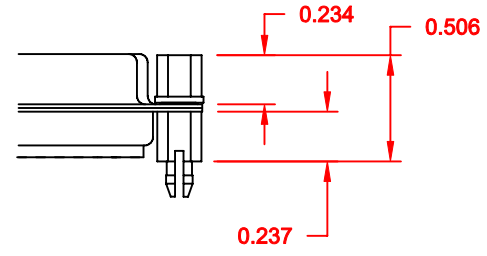

NOTE: 4-40 FEMALE SCREW LOCK IS REMOVABLE

DO NOT SCALE FROM DRAWING

	THESE DRAWINGS AND SPECIFICATIONS ARE THE PROPERTY OF NorComp AND SHALL NOT BE REPRODUCED, COPIED OR USED AS THE BASIS FOR THE MANUFACTURE OF SALE OF APPARATUS WITHOUT WRITTEN PERMISSION.		DRAWN: WAYNE ROBBINS	DATE: 11-28-05
			CHECKED:	DATE:
<h1>NorComp</h1>		SCALE:	SHEET 3 OF 3	REV 5
		DWG NO. 171-YYY-213RYY1		

RoHS COMPLIANT