

**NEW**

### SMD Choke Coils

Singapore

Series: **Magnetic shielded type**

Type: **ELL6□H**

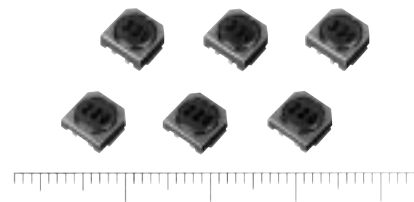

SMD type choke coils (2.5 mm, 3.0 mm)

ELL 6□H  
Type

#### ■ Features

- Thin type (height 2.5 mm, 3.0 mm)
- Higher reliability in mounting by separated user terminal and internal connection.
- Capable of corresponding big current

#### ■ Recommended Applications

- Videos, Audio, Mobile communications, Electric battery driving equipment
- Choke coils for Chopper circuit decoupling choked in DC/DC convertor circuit

#### ■ Cautions for Use

Convertor electric power of DC/DC convertor

- Chopper type : 1 W max.
- Operating temperature
- 105 °C max. (Including self-temperature rise)

#### ■ Explanation of Part Numbers

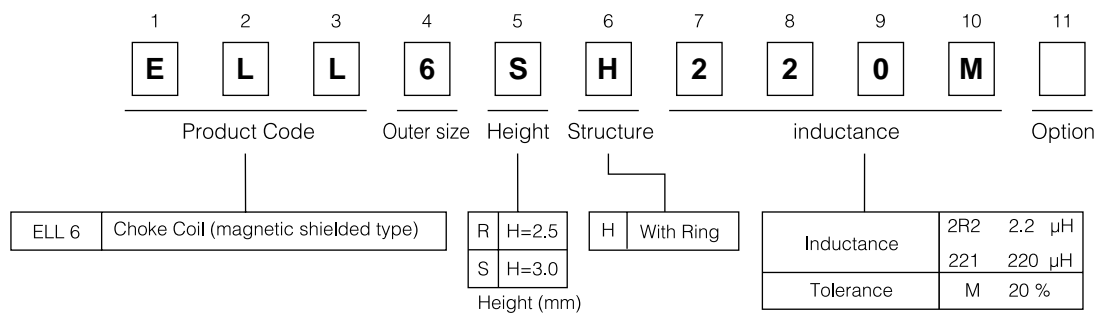

### ■ Dimensions in mm (not to scale)

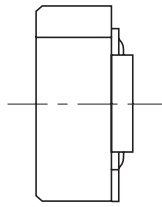
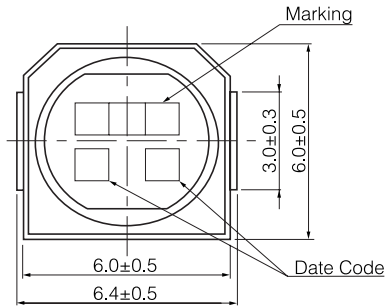

### ■ Connections (Top view)

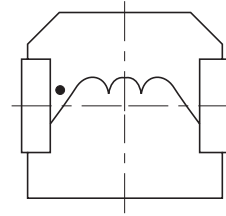

### ■ Recommended land patterns in mm (not to scale)

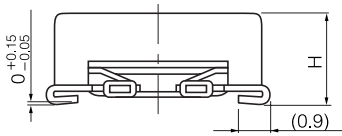

Type	Height
ELL6RH	2.5±0.3 mm
ELL6SH	3.0±0.3 mm

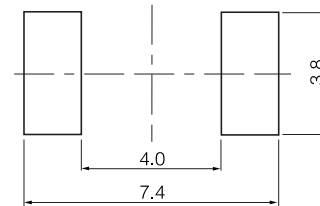

### ■ Characteristics (Reference)

Inductance at 100 kHz Tol. ± 20 %	DCR		Current (max.)		Marking
	at 20 °C Tol. ± 20 %		ELL6RH H=2.5 mm	ELL6SH H=3.0 mm	
1.0 μH	ELL6RH H=2.5 mm	ELL6SH H=3.0 mm	ELL6RH H=2.5 mm	ELL6SH H=3.0 mm	1R0
1.5	0.019 Ω	0.019 Ω	3000 mA	3400 mA	1R5
2.7	0.024	0.024	2400	3200	2R7
3.3	0.039	0.031	1800	2400	3R3
4.7	0.044	0.034	1600	2200	4R7
5.1	—	0.042	—	2000	5R1
5.6	0.056	—	1550	—	5R6
6.2	—	0.049	—	1800	6R2
6.8	0.062	—	1400	—	6R8
7.5	—	0.052	—	1500	7R5
8.2	0.080	—	1250	—	8R2
10	0.087	0.061	1200	1400	100
12	0.095	0.065	1100	1300	120
15	0.13	0.071	1000	1200	150
18	0.15	0.096	850	1100	180
22	0.17	0.11	800	1000	220
27	0.22	0.14	700	900	270
33	0.26	0.16	650	800	330
39	0.38	0.18	600	700	390
47	0.41	0.24	550	650	470
56	0.48	0.27	500	600	560
68	0.54	0.29	450	550	680
82	0.77	0.52	400	500	820
100	0.87	0.60	350	450	101
120	1.00	0.68	300	400	121
150	1.50	0.75	280	370	151
180	1.80	0.86	250	350	181
180	2.00	1.20	230	300	181

\* Current: This indicates the value of current when the inductance is 80% more than nominal value and temperature rising Δt=45 °C lower at D.C superposition. (at 20 °C)