

DATA SHEET

MKP 338 4 X2
**Interference suppression film
capacitors**

Product Specification
NEW
File under BCcomponents, BC05

2001 Jun 22

Interference suppression film capacitors MKP 338 4 X2

MKP RADIAL POTTED TYPE

PITCH 15/22.5/27.5/37.5/55 mm

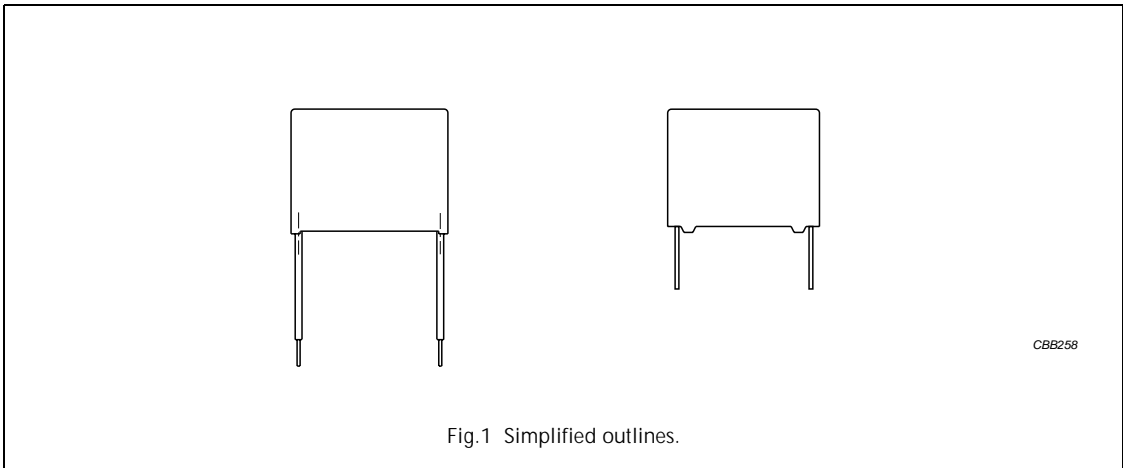

FEATURES

- 15 to 55 mm lead pitch
- Supplied loose in box
- Consists of a low-inductive wound cell of metallized polypropylene film, potted in a flame-retardant case
- Fixed and insulated leads.

APPLICATIONS

- For X2 electromagnetic interference suppression
- Specially designed to meet the requirements of the "IEC 60384-14 2nd edition and EN 132400", requiring a 2.5 kV peak pulse voltage test, and the UL1283 specifications.

DETAIL SPECIFICATION

For more detailed data and test requirements see "Type detail specification HQN-384-14/120".

QUICK REFERENCE DATA⁽¹⁾

DESCRIPTION	VALUE
Capacitance range (E12 series)	0.01 to 10 μ F
Capacitance tolerance	\pm 20%; \pm 10%
Rated (AC) voltage, 50 to 60 Hz	300 V
Rated (DC) voltage	630 V
Climatic category	55/105/56/B
Rated temperature	105 °C
Maximum application temperature	105 °C
Reference specifications	IEC 60384-14 2nd edition and EN 132400
Safety approvals:	ENEC; UL1283 and CSA-C22.2 No.8
Materials	qualified in accordance with UL94V-O
Safety class	X2; across the line

Note



1. Under development.

Interference suppression film capacitors

MKP 338 4 X2

SAFETY APPROVALS AND SAFETY TEST REPORT

Approvals

SAFETY APPROVALS (X2)		VOLTAGE	VALUE	FILE NUMBERS
	UL1283 and CSA-C22.2 No.8	300 V (AC)	10 nF to 10 µF	pending
	EN132400	300 V (AC)	10 nF to 10 µF	pending

Safety test report

SAFETY TEST REPORT	VOLTAGE	VALUE	FILE NUMBERS
CB TEST CERTIFICATE	300 V (AC)	10 nF to 10 µF: 55/105/56/B	pending

The EneC-approval together with the CB-Certificate replace all national approval marks of the following countries (they have already signed the ENEC-Agreement): Austria; Belgium; Czech. Republic; Denmark; Finland; France; Germany; Greece; Hungary; Ireland; Italy; Luxembourg; Netherlands; Norway, Portugal; Slovenian; Spain; Sweden; Switzerland and United Kingdom.

Interference suppression film capacitors

MKP 338 4 X2

COMPOSITION OF CATALOGUE NUMBER

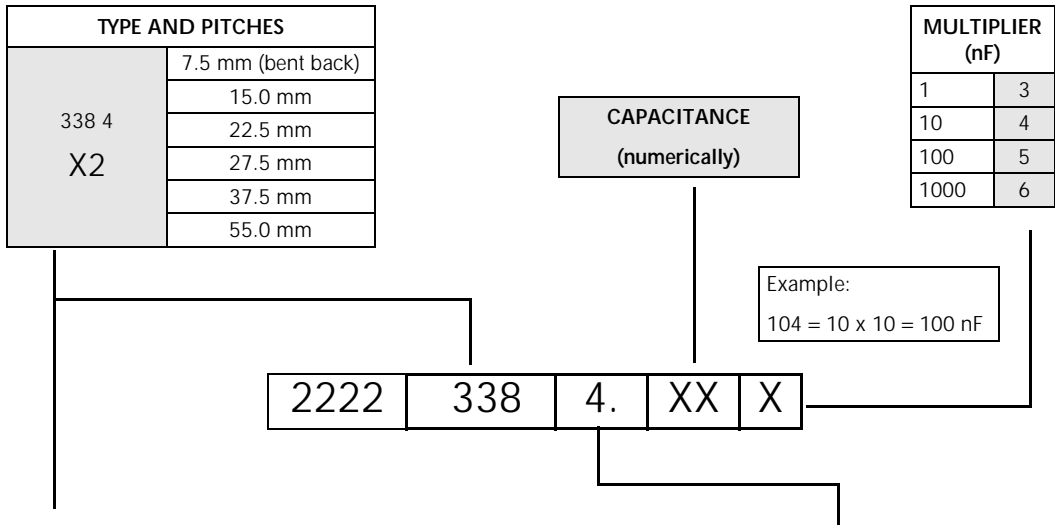

TYPE	PACKAGING	LEAD CONFIGURATION	C-TOL	PREFERRED TYPES
338 4 X2	loose in box	lead length 3.5 mm	±20%	44
		lead length 5.0 mm		40
		lead length 25.0 mm		41
	taped	15.0 mm bent back to 7.5 mm		4.
				ON REQUEST
338 4 X2	loose in box	insulated leads stranded Cu-wire 0.5 mm ² for 37.5 and 55 mm pitch	±20%	4.
		lead length 3.5 mm	±10%	45
		lead length 5.0 mm		42
		lead length 25.0 mm		43
		insulated leads stranded Cu-wire 0.5 mm ² for 37.5 and 55 mm pitch		4.
	taped	15.0 mm bent back to 7.5 mm		4.

Interference suppression film capacitors

MKP 338 4 X2

MKP 338 GENERAL DATA

PITCH 15/22.5/27.5 mm
 PITCH 7.5 mm (bent back leads)

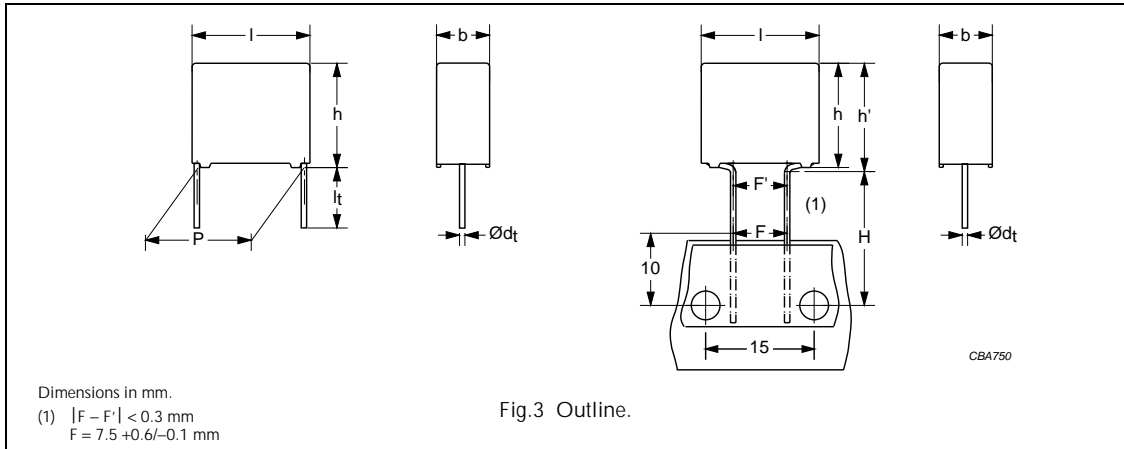

Specific reference data for the 300 V AC (X2) capacitors

DESCRIPTION	VALUE		
	at 1 kHz	at 10 kHz	at 100 kHz
Tangent of loss angle: $C \leq 470 \text{ nF}$ $470 \text{ nF} < C \leq 1 \mu\text{F}$ $1 \mu\text{F} < C \leq 3.3 \mu\text{F}$	$\leq 10 \times 10^{-4}$	$\leq 20 \times 10^{-4}$	$\leq 100 \times 10^{-4}$
	$\leq 20 \times 10^{-4}$	$\leq 70 \times 10^{-4}$	—
	$\leq 30 \times 10^{-4}$	—	—
Rated voltage pulse slope $(dU/dt)_R$ at 420 V (DC)	100 V/ μs		
R between leads, for $C \leq 0.33 \mu\text{F}$ at 100 V; 1 minute	$>15000 \text{ M}\Omega$		
RC between leads, for $C > 0.33 \mu\text{F}$ at 100 V; 1 minute	$>5000 \text{ s}$		
R between leads and case; 100 V; 1 minute	$>30000 \text{ M}\Omega$		
Withstanding (DC)voltage (cut off current 10 mA); rise time 100 V/s: $C \leq 1 \mu\text{F}$ $1 \mu\text{F} < C \leq 3.3 \mu\text{F}$	2200 V; 1 minute 1850 V; 1 minute		
Withstanding (AC) voltage between leads and case	2200 V; 1 minute		

Available 300 V AC (X2) versions

PACKAGING ⁽¹⁾	DIMENSIONS	C-tol	FIRST 9 DIGITS OF CATALOGUE NUMBER	ORDERING
Loose in box	lead length 3.5 mm	$\pm 20\%$	2222 338 44...	preferred
		$\pm 10\%$	2222 338 45...; note 2	on request
	lead length 5.0 mm	$\pm 20\%$	2222 338 40...	preferred
		$\pm 10\%$	2222 338 42...; note 2	on request
	lead length 25.0 mm	$\pm 20\%$	2222 338 41...	preferred
		$\pm 10\%$	2222 338 43...; note 2	on request
Taped	15.0 mm bent back to 7.5 mm	$\pm 20\%$	2222 338 4....	preferred
		$\pm 10\%$	2222 338 4....; note 2	on request

Notes

1. Taped on reel pitch = 27.5 mm is not available.
2. Other dimensions for $\pm 10\%$ tolerance values.

Interference suppression film capacitors

MKP 338 4 X2

 $U_{Rac} = 300 \text{ V (X2)}$; $U_{Rdc} = 630 \text{ V}$

loose and taped

C ⁽¹⁾ (μF)	DIMENSIONS ⁽²⁾ b × h × l (mm)	MASS (g)	CATALOGUE NUMBER			
			LOOSE IN BOX			REEL
			$l_t = 3.5 \pm 0.3 \text{ mm}$	$l_t = 5.0 \pm 0.3 \text{ mm}$	$l_t = 25.0 \pm 2.0 \text{ mm}$	H = 16.0 mm; P ₀ = 15.0 mm
			C-tol = $\pm 20\%$			
			catalogue number	last 5 digits	last 5 digits	last 5 digits
Pitch = $15.0 \pm 0.4 \text{ mm}$; $d_t = 0.60 \pm 0.06 \text{ mm}$						pitch = 7.5 mm (bent back)
0.01	5.0 × 11.0 (13.0) × 17.5	1.2	2222 338 44103	.. 40103	.. 41103	.. 48001
0.015			2222 338 44153	.. 40153	.. 41153	.. 48002
0.022			2222 338 44223	.. 40223	.. 41223	.. 48003
0.033			2222 338 44333	.. 40333	.. 41333	.. 48004
0.047			2222 338 44473	.. 40473	.. 41473	.. 48005
0.068			2222 338 44683	.. 40683	.. 41683	.. 48006
0.1	6.0 × 12.0 (14.0) × 17.5	1.4	2222 338 44104	.. 40104	.. 41104	.. 48007
Pitch = $15.0 \pm 0.4 \text{ mm}$; $d_t = 0.80 \pm 0.08 \text{ mm}$						pitch = 7.5 mm (bent back)
0.15	7.0 × 13.5 (15.5) × 17.5	1.9	2222 338 44154	.. 40154	.. 41154	.. 48008
0.22	8.5 × 15.0 (17.0) × 17.5	2.6	2222 338 44224	.. 40224	.. 41224	.. 48009
0.33	10.0 × 16.5 (18.5) × 17.5	3.1	2222 338 44334	.. 40334	.. 41334	.. 48011
Pitch = $22.5 \pm 0.4 \text{ mm}$; $d_t = 0.80 \pm 0.08 \text{ mm}$						pitch = 7.5 mm (bent back)
0.47	8.5 × 18.0 × 26.0	4.5	2222 338 44474	.. 40474	.. 41474	not available
0.68	10.0 × 19.5 × 26.0	5.5	2222 338 44684	.. 40684	.. 41684	
1.0	12.0 × 22.0 × 26.0	7.8	2222 338 44105	.. 40105	.. 41105	
Pitch = $27.5 \pm 0.4 \text{ mm}$; $d_t = 0.80 \pm 0.08 \text{ mm}$						pitch = 7.5 mm (bent back)
1.5	15.0 × 25.0 × 31.0	12.8	2222 338 44155	.. 40155	.. 41155	not available
2.2	18.0 × 28.0 × 31.0	17.2	2222 338 44225	.. 40225	.. 41225	
3.3	21.0 × 31.0 × 31.0	20.4	2222 338 44335	.. 40335	.. 41335	

Notes

- Under development.
- Dimensions in brackets for bent back leads.

Interference suppression film capacitors

MKP 338 4 X2

MKP GENERAL DATA

PITCH 37.5/55 mm

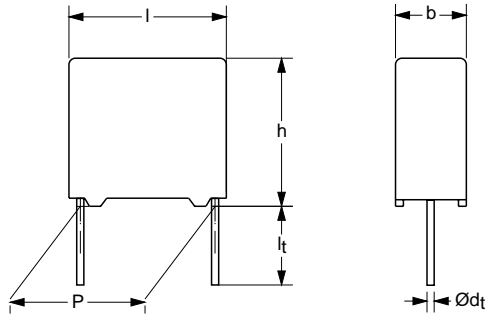

CBA196

Fig.4 Outline.

Specific reference data for the 300 V AC (X2) capacitors

DESCRIPTION	VALUE
Tangent of loss angle	at 1 kHz
2.2 μF < C \leq 4.7 μF	$\leq 50 \times 10^{-4}$
4.7 μF < C \leq 10 μF	$\leq 100 \times 10^{-4}$
Rated voltage pulse slope (dU/dt) _R at 420 V (DC)	100 V/ μs
RC between leads at 100 V; 1 minute	>5000 s
R between leads and case; 100 V; 1 minute	>30000 M Ω
Withstanding (DC) voltage (cut off current 10 mA); rise time 100 V/s	1400 V; 1 minute
Withstanding (AC) voltage between leads and case	2200 V; 1 minute

Available 300 V AC (X2) versions

PACKAGING	DIMENSIONS	C-tol	FIRST 9 DIGITS OF CATALOGUE NUMBER	ORDERING
Loose in box	lead length 5.0 mm; note 1	$\pm 20\%$	2222 338 40...	preferred
		$\pm 10\%$	2222 338 42...; note 2	on request
	lead length 25.0 mm; note 1	$\pm 20\%$	2222 338 41...	preferred
		$\pm 10\%$	2222 338 43...; note 2	on request
	insulated leads stranded Cu-wire 0.5 mm ² for 37.5 and 55 mm pitch	$\pm 20\%$	2222 338 4....	on request
		$\pm 10\%$	2222 338 4....; note 2	on request

Notes

- Lead length 3.5 mm for pitch = 37.5 and 55 mm is not available.
- Other dimensions for $\pm 10\%$ tolerance values.

Interference suppression film capacitors

MKP 338 4 X2

 $U_{Rac} = 300 \text{ V (X2)}$; $U_{Rdc} = 630 \text{ V}$

loose

C ⁽¹⁾ (μF)	DIMENSIONS b × h × l (mm)	MASS (g)	CATALOGUE NUMBER	
			LOOSE IN BOX	
			$l_t = 5.0 \pm 1.0 \text{ mm}$	$l_t = 25.0 \pm 2.0 \text{ mm}$
			C-tol = $\pm 20\%$	
			catalogue number	last 5 digits
Pitch = $37.5 \pm 0.7 \text{ mm}$; $d_t = 1.0 \pm 0.1 \text{ mm}$				
4.7	18.0 × 35.0 × 42.0	30.0	2222 338 40 475	... 41 475
6.8	21.0 × 38.0 × 42.0	35.0	2222 338 40 685	... 41 685
Pitch = $55.0 \pm 1.0 \text{ mm}$; $d_t = 1.0 \pm 0.1 \text{ mm}$				
10.0	21.0 × 38.0 × 59.5	50.0	2222 338 40 106	... 41 106

Note

- Under development.

Interference suppression film capacitors

MKP 338 4 X2

CONSTRUCTION

Description

- Low-inductive wound cell of metallized polypropylene (PP) film, potted with epoxy resin (for original pitch ≤ 27.5 mm) and polyurethane and epoxy resin (for pitch >27.5 mm) in a flame-retardant case
- Radial leads, solder-coated
- Small stand-off pips allow removal of solder flux etc. during cleaning of the printed-circuit board
- Radial insulated leads: stranded Cu-wire with PVC isolation for pitch >27.5 mm on request

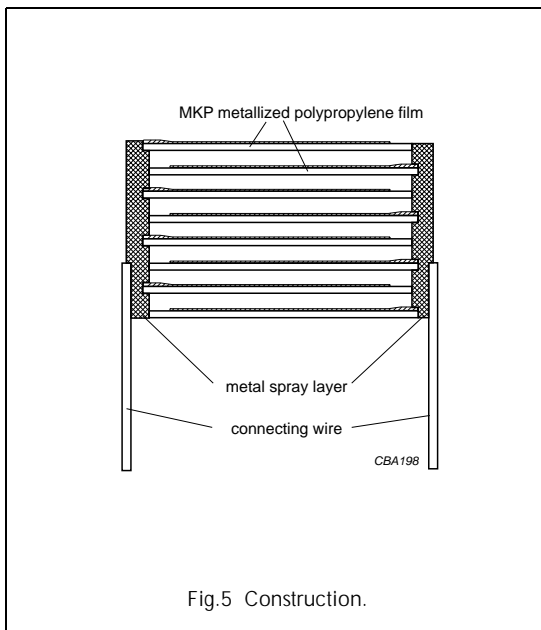

Mounting

NORMAL USE

The capacitors are designed for mounting on printed-circuit boards. The capacitors packed in bandoliers are designed for mounting on printed-circuit boards by means of automatic insertion machines.

For detailed tape specifications refer to this handbook, chapter "Packaging information".

SPECIFIC METHOD OF MOUNTING TO WITHSTAND VIBRATION AND SHOCK

In order to withstand vibration and shock tests, it must be ensured that the stand-off pips are in good contact with the printed-circuit board:

- For pitches ≤ 15 mm capacitors shall be mechanically fixed by the leads.
- For larger pitches the capacitors shall be mounted in the same way and the body clamped.

SPACE REQUIREMENTS ON PRINTED-CIRCUIT BOARD

The maximum length and width of film capacitors is shown in Fig.6:

- Eccentricity as in Fig.6. The maximum eccentricity is smaller than or equal to the lead diameter of the product concerned.
- Product height with seating plane as given by "IEC 60717" as reference: $h_{\max} \leq h + \Delta$ mm or $h_{\max} \leq h' + \Delta$ mm.

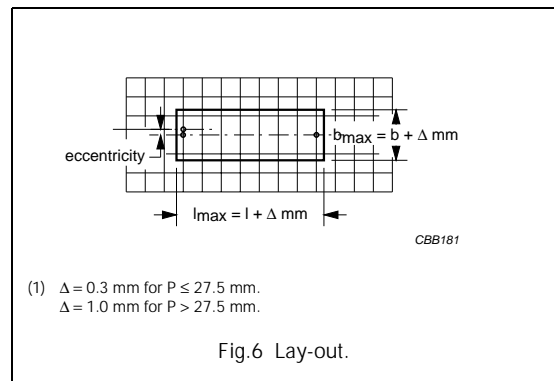

Storage temperature

- Storage temperature: $T_{\text{stg}} = -25$ to $+40$ °C with RH maximum 80% without condensation.

RATINGS AND CHARACTERISTICS REFERENCE CONDITIONS

Unless otherwise specified, all electrical values apply to an ambient temperature of 23 ± 1 °C, an atmospheric pressure of 86 to 106 kPa and a relative humidity of $50 \pm 2\%$.

For reference testing, a conditioning period shall be applied over 96 ± 4 hours by heating the products in a circulating air oven at the rated temperature and a relative humidity not exceeding 20%.

Interference suppression film capacitors

MKP 338 4 X2

CHARACTERISTICS

Capacitance

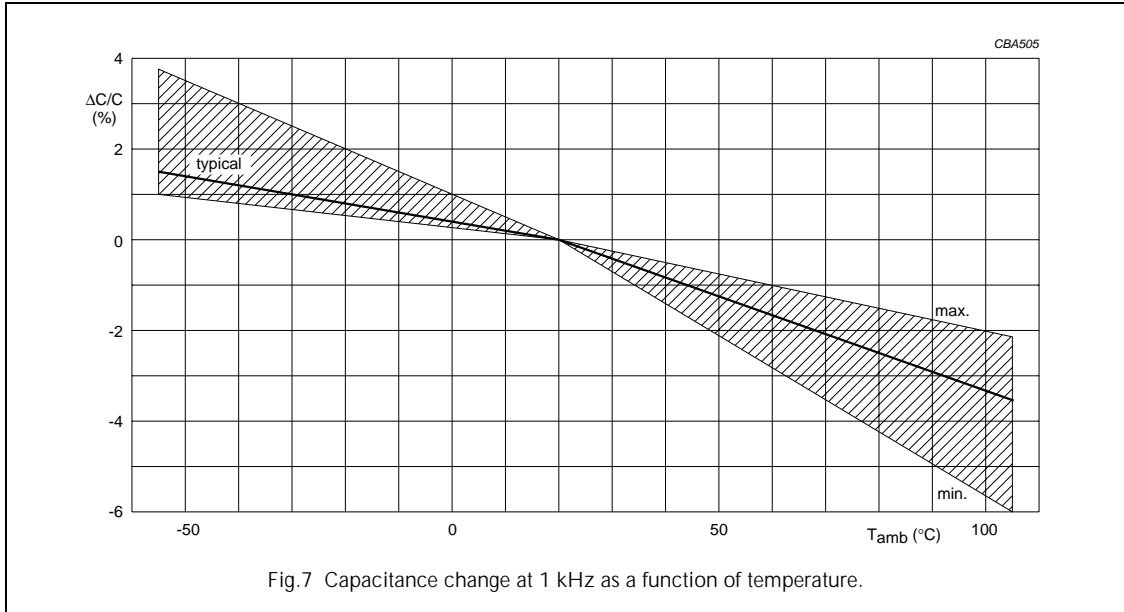

Tangent of loss angle

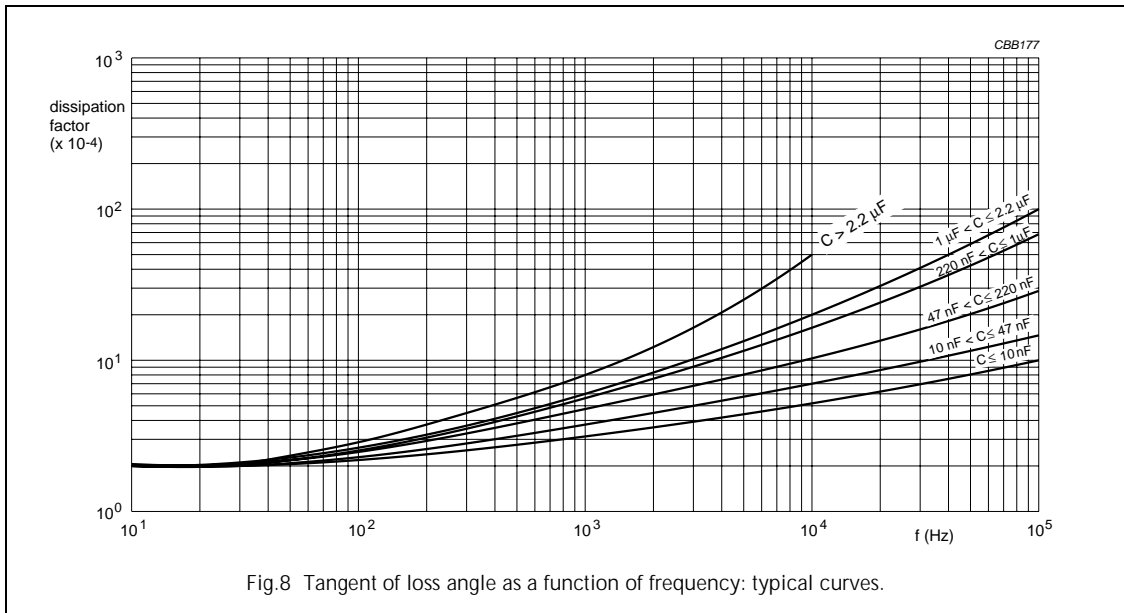

Interference suppression film capacitors

MKP 338 4 X2

Impedance

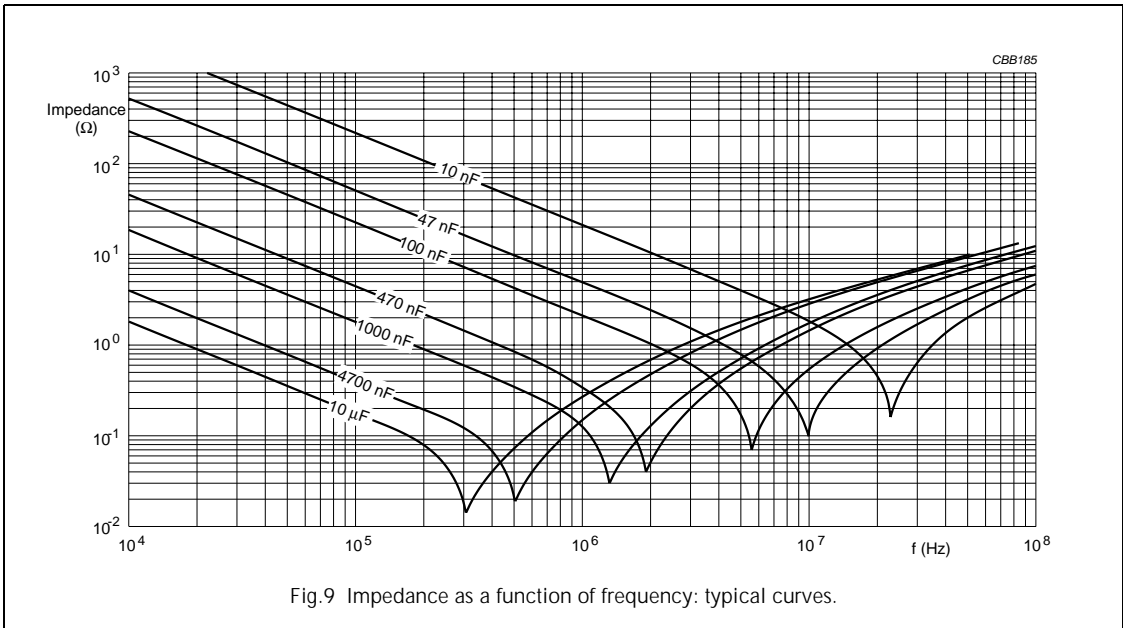

Fig.9 Impedance as a function of frequency: typical curves.

Resonant frequency

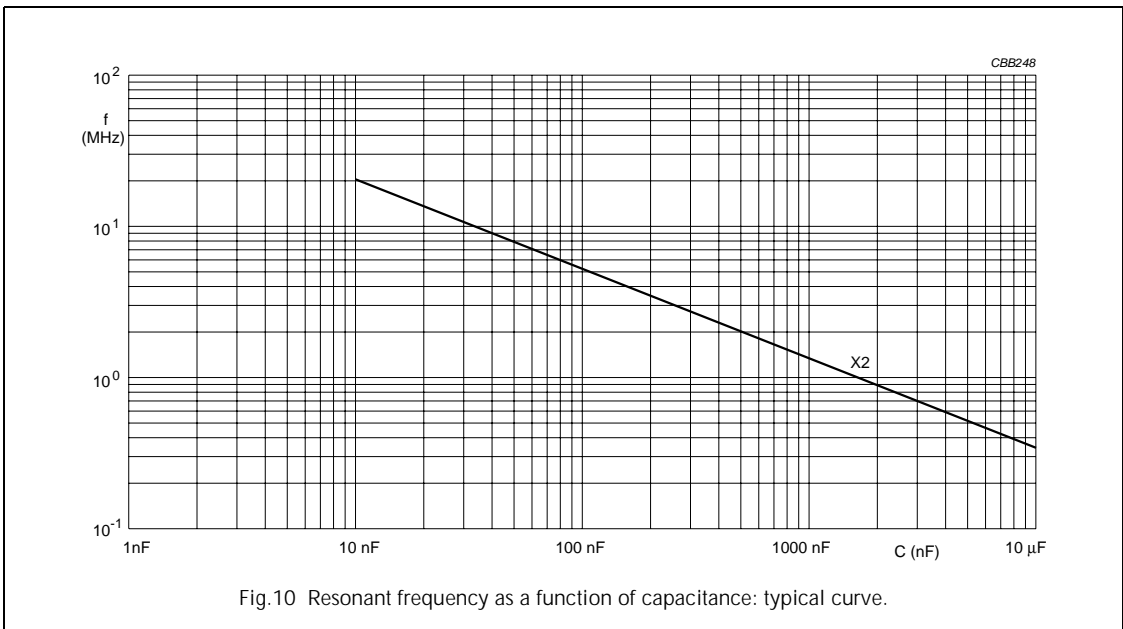
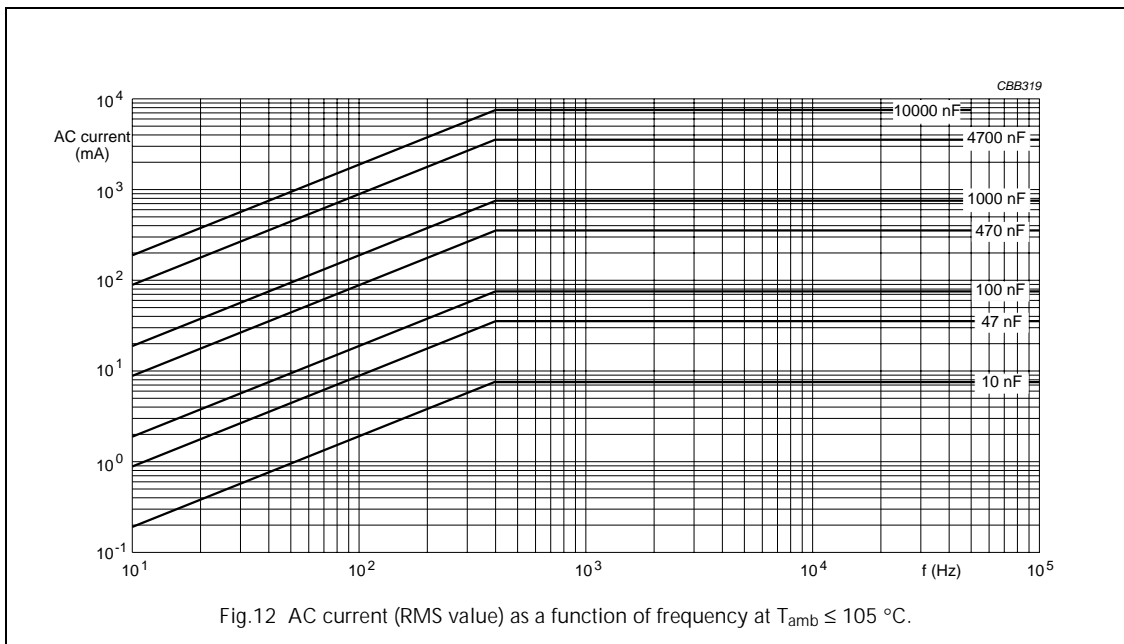
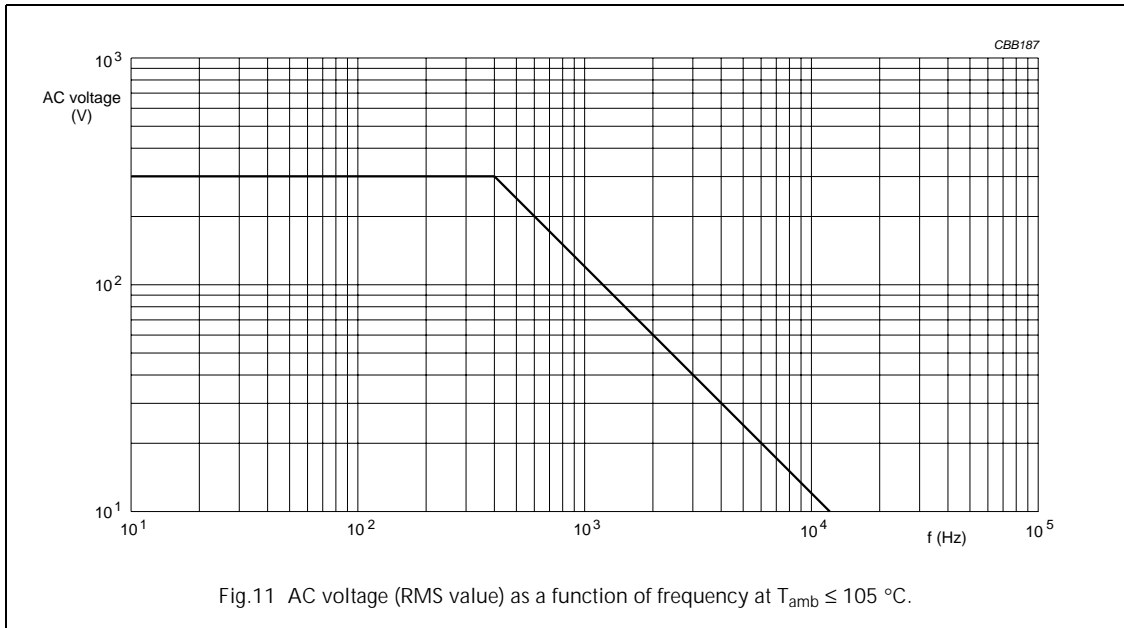

Fig.10 Resonant frequency as a function of capacitance: typical curve.

Interference suppression film capacitors

MKP 338 4 X2

Maximum RMS voltage and AC current (sinewave) as a function of frequency for $T_{amb} \leq 105 \text{ }^{\circ}\text{C}$



Interference suppression film capacitors

MKP 338 4 X2

Insulation resistance

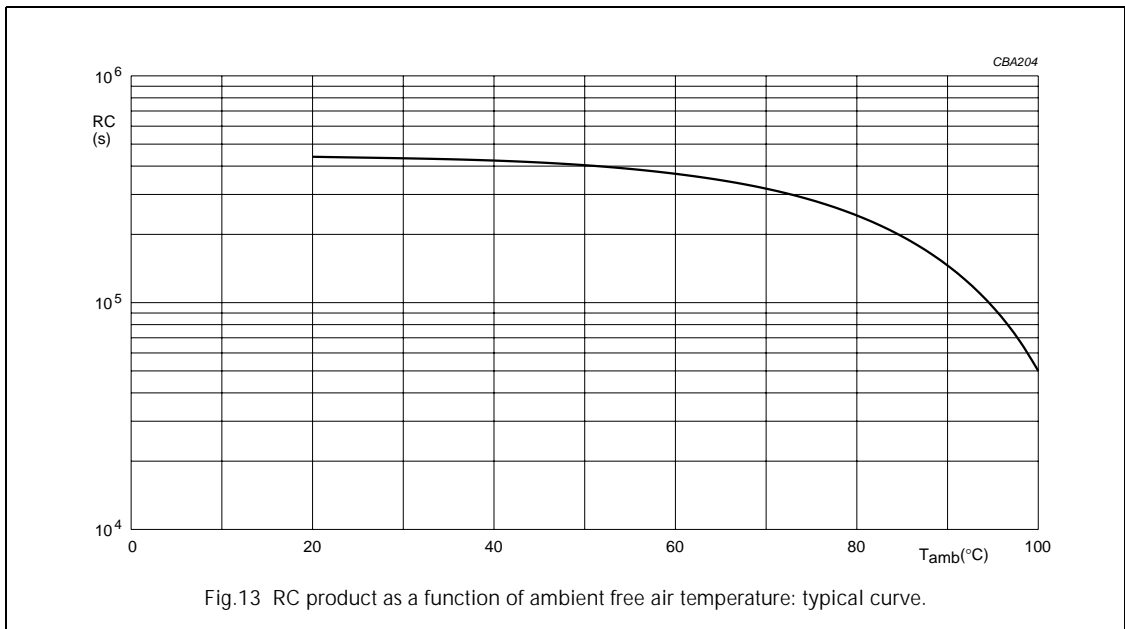

Fig.13 RC product as a function of ambient free air temperature: typical curve.

APPLICATION NOTES

- For X2 electromagnetic interference suppression in across the line applications (50/60 Hz) with a maximum mains voltage of 300 V (AC) $\pm 10\%$ instability.
- These capacitors are not intended for continuous pulse applications. For these situations, capacitors of the AC and pulse program must be used, such as: 2222 375; 2222 383 or 2222 479
- The maximum ambient temperature must not exceed 105 °C.
- Rated voltage pulse slope:
 - If the pulse voltage is lower than the rated voltage, the values of the specific reference data can be multiplied by 420 V (DC) and divided by the applied voltage.

Interference suppression film capacitors

MKP 338 4 X2

MARKING

Product marking

The capacitors are marked (see Figs 14 to 15) with the following information:

1. Rated capacitance code in accordance with "IEC 60062"
2. Tolerance on rated capacitance; M = $\pm 20\%$; K = $\pm 10\%$
3. Rated (AC) voltage (e.g. 300 V)
4. Sub-class (e.g. X2)
5. Manufacturer's type designation (e.g. 338 4)
6. Code for dielectric material (MKP)
7. Manufacturer and origin (" " Belgium; "PL" Poland)
8. Year and week of manufacture (e.g. 0133).

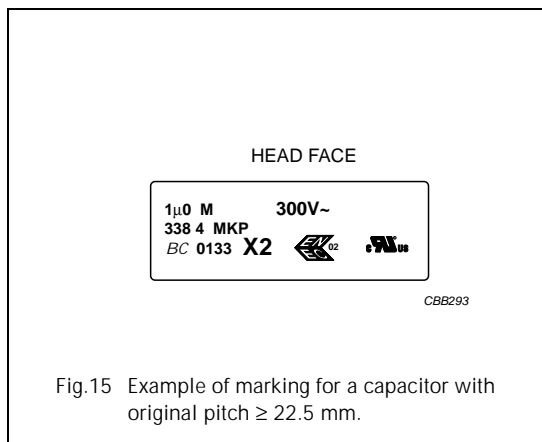
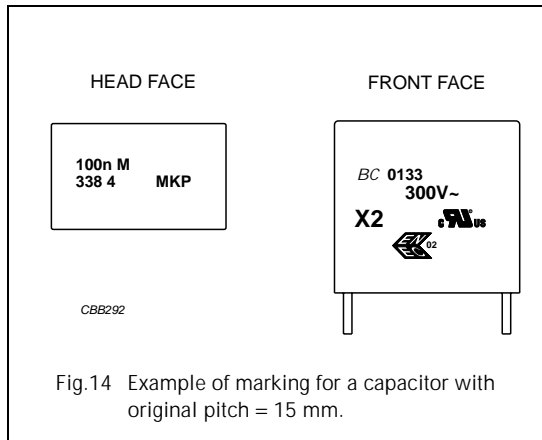

Interference suppression film capacitors

MKP 338 4 X2

Package marking

The package containing the capacitors is marked as shown Fig.16.

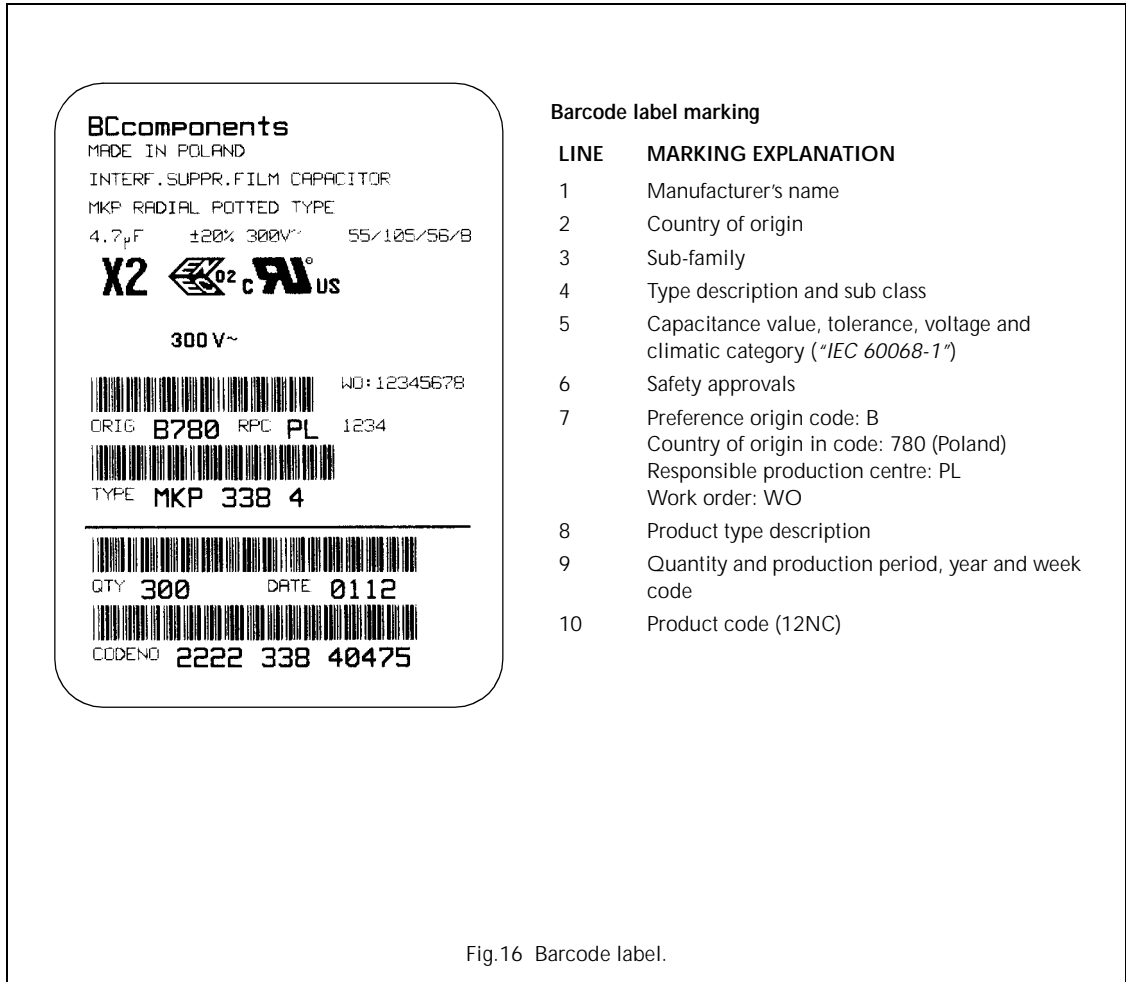

Fig.16 Barcode label.

Interference suppression film capacitors

MKP 338 4 X2

QUICK REFERENCE TEST REQUIREMENTS

TEST	PROCEDURE (quick reference)	REQUIREMENTS
Robustness of leads		
Tensile strength: "IEC 60068-2-21"	load 10 N; 10 s	no visible damage legible marking $ \Delta C/C \leq 5\%$ $\Delta \tan \delta \leq 80 \times 10^{-4}$ ($C \leq 1 \mu\text{F}$); note 1 $\Delta \tan \delta \leq 50 \times 10^{-4}$ ($C > 1 \mu\text{F}$); note 1
Bending: "IEC 60068-2-21"	load 5 N; $4 \times 90^\circ$	
Resistance to soldering heat: "IEC 60068-2-20"	solder bath: 260 °C; 10 s	
Component solvent resistance	isopropyl alcohol; 23 °C; 5 minutes	
Robustness of component (fixed leads only)		
Rapid change of temperature: "IEC 60068-2-14"	5 cycles 1 cycle = 30 minutes at -55°C and 30 minutes at 105°C	$ \Delta C/C \leq 5\%$ $\Delta \tan \delta \leq 80 \times 10^{-4}$ ($C \leq 1 \mu\text{F}$); note 1 $\Delta \tan \delta \leq 50 \times 10^{-4}$ ($C > 1 \mu\text{F}$); note 1
Vibration: "IEC 60068-2-6"	10 to 55 Hz; amplitude 0.75 mm; 6 hours	
Shock: "IEC 60068-2-27"	half sinewave; 490 m/s ² ; 11 ms	
Climatic sequence		
Dry heat: "IEC 60068-2-2"	16 hours; 105°C	$ \Delta C/C \leq 5\%$ $\Delta \tan \delta \leq 80 \times 10^{-4}$ ($C \leq 1 \mu\text{F}$); note 1 $\Delta \tan \delta \leq 50 \times 10^{-4}$ ($C > 1 \mu\text{F}$); note 1 Rins $\geq 50\%$ of specified value
Damp heat, cyclic, test Db, first cycle: "IEC 60068-2-30"		
Cold: "IEC 60068-2-1"	2 hours; -55°C	
Damp heat, cyclic, test Db, remaining cycles: "IEC 60068-2-30"		
Voltage proof: "IEC 60384-14"	$V_p = 1290 \text{ V (DC)}$; 1 minute	
Other applicable tests		
Damp heat, steady state: "IEC 60068-2-3"	56 days; 40°C ; 90 to 95% RH no load $V_p = 1290 \text{ V (DC)}$; 1 minute	$ \Delta C/C \leq 5\%$ $\Delta \tan \delta \leq 80 \times 10^{-4}$ ($C \leq 1 \mu\text{F}$); note 1 $\Delta \tan \delta \leq 50 \times 10^{-4}$ ($C > 1 \mu\text{F}$); note 1 Rins $\geq 50\%$ of specified value
Endurance (AC): "IEC 60384-14"	$3 \times 2.5 \text{ kV}$ pulse voltage for X2; 1000 hours; $1.25 \times U_{\text{RAC}}$ at 105°C ; once per hour; 0.1 s; 1000 V (RMS) via resistor of 47Ω ; $V_p = 1290 \text{ V (DC)}$; 1 minute	

Interference suppression film capacitors

MKP 338 4 X2

TEST	PROCEDURE (quick reference)	REQUIREMENTS
Charge and discharge: "IEC 60384-14"	10000 cycles; 5 ms; $1.5 \times dV/dt$	$ \Delta C/C \leq 10\%$ $\Delta \tan \delta \leq 80 \times 10^{-4}$ ($C \leq 1 \mu F$); note 1 $\Delta \tan \delta \leq 50 \times 10^{-4}$ ($C > 1 \mu F$); note 1 Rins $\geq 50\%$ of specified value
Passive flammability: "IEC 60384-14"	class B	no burning
Active flammability: "IEC 60384-14"	20×2.5 kV discharge	no burning
Heat storage: "IEC 60384-14"	1000 hours; 105 °C	$ \Delta C/C \leq 5\%$ $\Delta \tan \delta \leq 80 \times 10^{-4}$ ($C \leq 1 \mu F$); note 1 $\Delta \tan \delta \leq 50 \times 10^{-4}$ ($C > 1 \mu F$); note 1
Resistance to soldering heat with preheating: "IEC 60384-14"	preheating: 105 °C; solder bath: 260 °C; 10 s	$ \Delta C/C \leq 5\%$ $\Delta \tan \delta \leq 80 \times 10^{-4}$ ($C \leq 1 \mu F$); note 1 $\Delta \tan \delta \leq 50 \times 10^{-4}$ ($C > 1 \mu F$); note 1
Active flammability test	voltage proof up to $2 \times$ peak impulse voltage of 4.13 or until breakdown (100 V/sec, current limited 2mA) failed capacitors connected to a 300 V (AC) power supply during 5 minutes.	no burning

Note

1. Measuring frequency 10 kHz for $C \leq 1 \mu F$ and 1 kHz for $C > 1 \mu F$.