

# Conductive Level Controller 61F-D21T-V1

## Ideal for level control for industrial facilities and equipment.

- Outputs can be set to self-hold at ON or OFF using self-holding circuits.
- Sensitivity adjustment of operating resistance from 10 to 100 kΩ for application to a wide range of liquids.
- Delay timer to prevent relay contact chattering caused by waves.
- CE marking, cUL application pending.
- Easy wiring with ferrules  
2 × 2.5 mm<sup>2</sup> solid or 2 × 1.5 mm<sup>2</sup> standard ferrules.
- CE mark compliance certified by third party.  
UL certification pending.

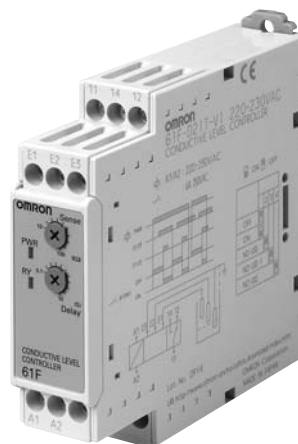

CE

## Model Number Structure

### ■ Model Number Legend

61F-□□

1 2 3

#### 1. Basic Model

61F: Conductive Level Controller

#### 2. Functions

D21T-V1: Automatic liquid supply operation/  
Automatic liquid drainage operation

#### 3. Supply Voltage

24 VAC: 24 VAC

115 VAC: 115 VAC

220-230 VAC: 220 to 230 VAC

## Ordering Information

### ■ List of Models

Conductive Level Controller	Supply voltage	Model
	24 VAC	<b>61F-D21T-V1 24 VAC</b>
	115 VAC	<b>61F-D21T-V1 115 AC</b>
	220 to 230 VAC	<b>61F-D21T-V1 220 to 230 VAC</b>

## Specifications

<b>Rated voltage</b>	24 VAC, 115 VAC, 220 to 230 VAC
<b>Operating voltage range</b>	85% to 110% of rated voltage
<b>Voltage between electrodes</b>	6 VAC p-p (approx. 20 Hz)
<b>Power consumption</b>	5 VA max.
<b>Operating resistance</b>	10 k $\Omega$ to 100 k $\Omega$ (variable)
<b>Reset resistance</b>	250 k $\Omega$ max.
<b>Response time</b>	Approx. 0.1 to 10 s (variable)
<b>Cable length</b>	100 m max. with completely insulated (600 V) cable with 3 conductors (0.75 mm <sup>2</sup> )
<b>Control output</b>	6 A at 250 VAC for resistive load at 20°C, 1 A at 250 VAC for inductive load $\cos\phi = 0.4$ at 20°C
<b>Indicators</b>	Green LED: Power, Yellow LED: Control output
<b>Ambient temperature</b>	Operating: -20 to 60°C, Storage: -30 to 70°C (with no condensation or icing)
<b>Ambient humidity</b>	Operating: 25% to 85%, Storage: 25% to 85%
<b>Elevation</b>	2,000 m max.
<b>Insulation resistance</b>	100 M $\Omega$ min. (at 500 VDC) between power supply section, electrode section, and contact section
<b>Dielectric strength</b>	2,000 VAC 50/60 Hz for 1 min between power source section, electrode section, and contact section
<b>Vibration resistance</b>	Vibration of 10 to 55 Hz and acceleration of 50 m/s <sup>2</sup> for 5 min. 10 times each in X, Y, and Z directions
<b>Shock resistance</b>	100 m/s <sup>2</sup> 3 times each in 6 directions on 3 axes
<b>Installation environment</b>	Overvoltage Category II, Pollution Degree 2
<b>Safety standards</b>	EN61010-1
<b>EMC</b>	EN61326 Industrial applications

# Connections

## ■ Operation Diagram

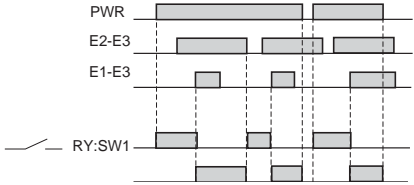

## ■ Wiring Diagram

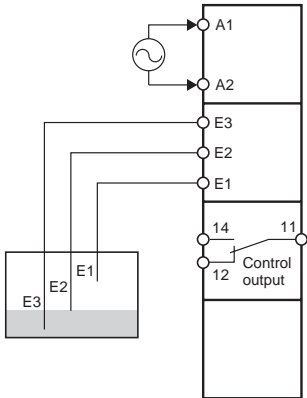

# Nomenclature

## ■ Front

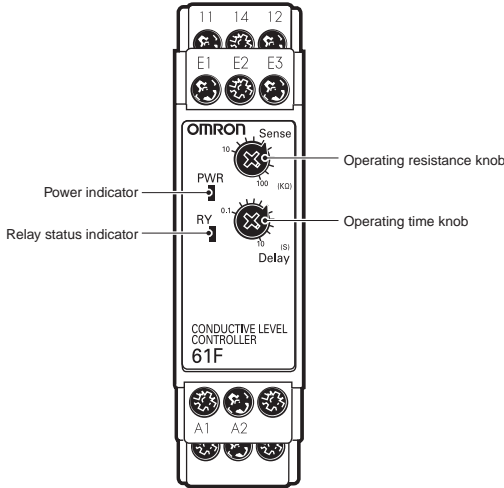

## ■ Bottoms

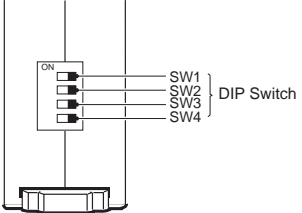

## Indicators

Item	Meaning
Power indicator (PWR: Green)	Lit when power is being supplied.
Relay status indicator (RY: Yellow)	Lit when relay is operating.

## Setting Knobs

Item	Usage
Operating resistance knob	Used to set the operating resistance to 10 to 100 kΩ.
Operating time knob	Use to set the operating time to 0.1 to 10 s.

## DIP Switch Functions

	Function	Function		Default
		OFF	ON	
SW1	Supply/drainage selection	OFF	Automatic liquid supply operation	OFF
		ON	Automatic liquid drainage operation	
SW2	Not used.	OFF	Not used.	OFF
		ON	Not used.	
SW3	Not used.	OFF	Not used.	OFF
		ON	Not used.	
SW4	Not used.	OFF	Not used.	OFF
		ON	Not used.	

# Dimensions

---

61F-D21T-V1

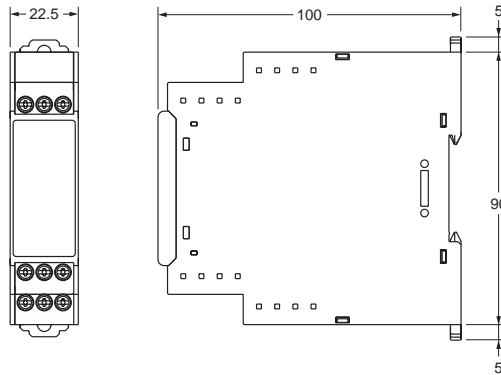

# Safety Precautions

## ■ Precautions for Safe Use

- There is a remote risk of electrical shocks. Do not touch terminals while electricity is being supplied.
- There is a remote risk of electrical shocks, fire, or failure occurring. Do not disassemble, repair, or modify the product.
- When attaching the product to the DIN Rail, attach it firmly with screws. When the screws are not tightened firmly, the product or wiring may become disconnected due to vibrations or shocks.
- When attaching the product to the DIN Rail, ensure that the product has been attached firmly.
- If the thickness of a mounting panel is not adequate, or a mistake has been made during installation, the product may become disconnected.
- Ensure that terminal screws have been tightened firmly.  
Recommended torque: 0.49 N·m  
Proof torque: 0.59 N·m
- When using the product, ensure that the wiring is correct before turning ON the power. Incorrect wiring may result in electrical shocks, injuries, accidents, failure, or malfunctions.
- Use a power supply voltage that is within the range of the specifications.
- Use a control source and power supply or power lines that provide inputs with appropriate specifications.  
Failure to do so may result in failures, burning, or electrical shocks.
- Do not install near heat-generating devices (coils, or devices that use coils).
- Be sure to confirm terminal numbers for correct wiring.
- Ensure that wiring is correct. Double-check materials such as connection charts and circuit diagrams.
- Properly ground the grounding terminal. Ensure that the common electrode terminal has been properly grounded.  
Doing so can alleviate effects from noise to a certain extent.
- If electrodes make contact with liquid, purchase and use a separator to prevent such contact.
- Keep an appropriate distance from devices that generate high-frequency noise (e.g., high-frequency welders, electronic sewing machines).

## Do not keep, install, or use this product in the following environments.

- Outdoors, or places subject to direct sunlight or severe weather conditions.
- Places where temperature and humidity exceed the allowable range of the product specifications.
- Places where there are extreme changes in temperature and humidity, or icing or condensation may occur.
- Places subject to static electricity or inductive noise.
- Places subject to electrical fields.
- Places where vibrations or physical shocks are strong.
- Places where flammable gases exist.
- Places where corrosive gases (in particular, sulfuric or ammonia gas) exist.
- Places with large amounts of dust or iron powder.
- Places where water or oil come in contact with the product.
- Places subject to salt-water splashes.

## ■ Precautions for Correct Use

### For Proper Use

1. Do not use the product in the following locations.
  - Places subject to radiant heat from heat generating devices.
  - Places subject to vibrations or physical shocks.
2. Make sure to use setting values appropriate for the controlled object. Failure to do so can cause unintended operation, and may result in accident or corruption of the product.
3. Do not use thinner or similar solvent for cleaning. Use commercial alcohol.
4. When discarding, properly dispose of the product as industrial waste.
5. Only use this product within a board whose structure allows no possibility for fire to escape.

### About Installation

1. When wiring, use only recommended crimp terminals.
2. Do not block areas around the product for proper dissipation of heat. (If you do not secure space for heat dissipation, life cycle of the product will be compromised.)
3. To avoid electrical shocks, make sure that power is not supplied to the product while wiring.
4. To avoid electrical shocks, make sure that power is not supplied to the product when performing DIP switch settings.

### Noise Countermeasures

1. Do not install the product near devices generating strong high frequency waves or surges.
2. When using a noise filter, check the voltage and current and install it as close to the product as possible.
3. In order to prevent inductive noise, wire the lines connected to the product separately from power lines carrying high voltages or currents. Do not wire in parallel with or on the same cable as power lines.  
Other measures for reducing noise include running lines along separate ducts and using shield lines.

## To avoid faulty operations, malfunctions, or failure, observe the following operating instructions.

1. Make sure to use power supply for operations, inputs, and transformer with the appropriate capacity and rated burden.
2. Maintenance and handling of this product may only be performed by qualified personnel.
3. Using this product for thyristor controls or inverters will result in errors.



# Warranty and Application Considerations

## Read and Understand this Catalog

Please read and understand this catalog before purchasing the products. Please consult your OMRON representative if you have any questions or comments.

## Warranty and Limitations of Liability

### WARRANTY

OMRON's exclusive warranty is that the products are free from defects in materials and workmanship for a period of one year (or other period if specified) from date of sale by OMRON.

OMRON MAKES NO WARRANTY OR REPRESENTATION, EXPRESS OR IMPLIED, REGARDING NON-INFRINGEMENT, MERCHANTABILITY, OR FITNESS FOR PARTICULAR PURPOSE OF THE PRODUCTS. ANY BUYER OR USER ACKNOWLEDGES THAT THE BUYER OR USER ALONE HAS DETERMINED THAT THE PRODUCTS WILL SUITABLY MEET THE REQUIREMENTS OF THEIR INTENDED USE. OMRON DISCLAIMS ALL OTHER WARRANTIES, EXPRESS OR IMPLIED.

### LIMITATIONS OF LIABILITY

OMRON SHALL NOT BE RESPONSIBLE FOR SPECIAL, INDIRECT, OR CONSEQUENTIAL DAMAGES, LOSS OF PROFITS, OR COMMERCIAL LOSS IN ANY WAY CONNECTED WITH THE PRODUCTS, WHETHER SUCH CLAIM IS BASED ON CONTRACT, WARRANTY, NEGLIGENCE, OR STRICT LIABILITY.

In no event shall the responsibility of OMRON for any act exceed the individual price of the product on which liability is asserted.

IN NO EVENT SHALL OMRON BE RESPONSIBLE FOR WARRANTY, REPAIR, OR OTHER CLAIMS REGARDING THE PRODUCTS UNLESS OMRON'S ANALYSIS CONFIRMS THAT THE PRODUCTS WERE PROPERLY HANDLED, STORED, INSTALLED, AND MAINTAINED AND NOT SUBJECT TO CONTAMINATION, ABUSE, MISUSE, OR INAPPROPRIATE MODIFICATION OR REPAIR.

## Application Considerations

### SUITABILITY FOR USE

OMRON shall not be responsible for conformity with any standards, codes, or regulations that apply to the combination of products in the customer's application or use of the products.

Take all necessary steps to determine the suitability of the product for the systems, machines, and equipment with which it will be used.

Know and observe all prohibitions of use applicable to this product.

NEVER USE THE PRODUCTS FOR AN APPLICATION INVOLVING SERIOUS RISK TO LIFE OR PROPERTY WITHOUT ENSURING THAT THE SYSTEM AS A WHOLE HAS BEEN DESIGNED TO ADDRESS THE RISKS, AND THAT THE OMRON PRODUCTS ARE PROPERLY RATED AND INSTALLED FOR THE INTENDED USE WITHIN THE OVERALL EQUIPMENT OR SYSTEM.

## Disclaimers

### PERFORMANCE DATA

Performance data given in this catalog is provided as a guide for the user in determining suitability and does not constitute a warranty. It may represent the result of OMRON's test conditions, and the users must correlate it to actual application requirements. Actual performance is subject to the OMRON *Warranty and Limitations of Liability*.

### CHANGE IN SPECIFICATIONS

Product specifications and accessories may be changed at any time based on improvements and other reasons. Consult with your OMRON representative at any time to confirm actual specifications of purchased product.

### DIMENSIONS AND WEIGHTS

Dimensions and weights are nominal and are not to be used for manufacturing purposes, even when tolerances are shown.

**ALL DIMENSIONS SHOWN ARE IN MILLIMETERS.**

To convert millimeters into inches, multiply by 0.03937. To convert grams into ounces, multiply by 0.03527.

Cat. No. N149-E1-01 **In the interest of product improvement, specifications are subject to change without notice.**

## OMRON Corporation

Industrial Automation Company

Industrial Devices and Components Division H.Q.

Industrial Control Components Department

Shiokoji Horikawa, Shimogyo-ku,

Kyoto, 600-8530 Japan

Tel: (81)75-344-7119/Fax: (81)75-344-7149