

Gemini

Low voltage electric
insulating switchboards

1SLC805001D0201



Table of contents

Introduction

1

Order codes

2

Technical information

3

Overall dimensions

4

Code list

5

ABB SACE and its commitment to protecting the environment



ABB SACE is one of the forerunners among the companies in the Group in dedicating considerable resources towards reaching its objectives of sustainable development and environmental protection. This is confirmed by the fact that all the company manufacturing sites have been awarded ISO 9001 quality certification and most of them have also been awarded ISO 14001 environmental management system certification. The plants in Frosinone and Patrica have also been awarded the Quality, Environment and Safety Integrated System certification and are certified in compliance with the BS 8800 Standards for health and safety in the workplace.

ABB SACE is actively involved in continuing the policy of improving environmental management by rationalizing the consumption of raw materials and energy, preventing pollution, respecting water and air, reducing noise levels to a minimum, reducing waste from production processes and carrying out periodic environmental checks at the main suppliers' premises.

By using analysis tools such as LCA (Life Cycle Assessment), from the initial design stages ABB SACE assesses and improves the environmental performance of its products throughout their entire life cycle in order to guarantee maximum efficiency in technical and energy performance during operation, control and reduce environmental impact in the manufacturing stage and define end-of-life procedures.

All these goals and activities are the result of a far-sightedness in adopting ecological policies and methods of reducing environmental impact and, here too, ABB SACE is, as already seen in the quality of its products, a leader on the Italian company scene.



Plant in Marostica (Vicenza-Italy)

Index

Characteristics of Gemini switchboards 1/2

Introduction

Characteristics of Gemini switchboards

Gemini, something completely different in switchboards

ABB SACE's Gemini range is revolutionizing the market of low voltage electric insulating switchboards.

The reason for this is that it is the first switchboard made in thermoplastic material, to which the co-injection molding technique gives the same mechanical characteristics as polyester. This means that it is extremely sturdy, with its rigid covering and expanded internal core. Moreover, it contains no fiberglass, a material that with time rises to the surface, jeopardizing the functioning and safety of switchboards made in polyester with which it is usually mixed.

Gemini switchboards have IP66 degree of protection (IP40 with the door open and with the appropriate components installed) and a very high resistance to chemical and atmospheric agents. This is the reason why Gemini guarantees excellent performances even in particularly severe operating conditions.

Strong outside and versatile inside, Gemini is fit for all applications

There are as many configurations as there are ABB devices for low voltage automation and distribution: moulded-case circuit breakers, modular circuit breakers, monitoring, control and signaling devices, wiring ducts and electrical connection systems.

All of these components give the "Gemini system" an enormous range of ad hoc solutions that are easy to assemble with the snap-on system.



1SLCB0503F0001

Gemini switchboards are made with co-injection, which ABB SACE is the first manufacturer in the electric field to use as a molding technique. This process obtains a "sandwich" of two materials with a compact external covering and an expanded core, guaranteeing the highest level of mechanical protection against impacts (IK10) without the need to add hardening substances.

Polyester is usually mixed with fiberglass, which, with wear, rises to the surface and can become a risk factor for skin burns that may occur during installation and maintenance and accidental contact.

Moreover, it causes deterioration of the technical strength and lasting characteristics of the material to which it is added: Gemini, on the other hand, keeps its mechanical characteristics in the long term.

The co-injection technique makes the manufacturing operations themselves safe because the products are completely finished when they come out of the mold without any flash or other surface irregularities.



1SLCB0503F0001



Introduction

Characteristics of Gemini switchboards

Nothing can be compared with Gemini, even when the switchboards have reached the end of their life cycle: they are totally ecologically compatible. The material used to manufacture them is 100% recyclable. Polyester, on the other hand, cannot be recovered.

Moreover, to make sure that correct disposal procedures are followed, instructions are provided about how to identify materials and what to do with the product once it has served its useful purpose.

Quality and safety

ABB's Gemini is designed and built in compliance with reference Standards that define its constructional and functional characteristics.

In particular, the IP66 degree certifies that Gemini is totally protected against the infiltration of solid bodies and is resistant to the penetration of jets of water similar to sea waves.

Absolute protection is provided by double insulation even in the event of indirect contact. Rated uninterrupted current can reach a threshold of 400 A.

Even in very difficult application circumstances, Gemini gives high-level performances, with resistance to fire and abnormal heat up to a temperature of 750 °C and a functioning temperature from -25 °C to 100 °C. Moreover, the material with which it is manufactured retains its characteristics for a long time since it is not subject to corrosion by chemical or atmospheric agents. Also it does not turn yellow when exposed to UV rays.



1SLC89604MF0001

Gemini is made in a thermoplastic material that has a very low halogen content and is 100% recyclable. The environmental compatibility of Gemini is an important objective right from the design phase where the Life Cycle Assessment (LCA) procedure, defined in 1990 during the Society of Environmental Toxicology and Chemistry Conference (Vermont, USA), is followed. Life Cycle Assessment is an objective method for analyzing the energy and environmental loads relating to a product, process or activity, carried out by identifying and quantifying energy, the materials used and emissions released into the environment. Divided into four phases, the assessment covers the entire life cycle of the product, process or activity, from the extraction and transformation of raw materials to manufacturing and distribution, and from usage to recycling and decommissioning.



1SLC89604MF0001



Introduction

Characteristics of Gemini switchboards

A switchboard that is not just one system, but three

Gemini is the result of design work conducted by ABB with the direct collaboration of switchboard manufacturers, installers and designers who considered versatility to be the discriminating element when purchasing a switchboard, equally as important as sturdiness and reliability.

Gemini fulfils this requirement by providing a product that can be used for three different purposes: in addition to the basic configuration it also provides the components necessary for equipping it as an automation switchboard or as a distribution and mixed switchboard.

In all applications, compatibility with ABB protection, control and monitoring products means that a real system of integrated and complementary functions can be configured.

Typical examples of some Gemini applications can be seen in installations in industrial production departments and on board machines, in galvanization plants and varnishing cabins, in petrol stations and car-washing plants, boiler-rooms, car parks, shopping malls and in any other environments where distribution and automation demand specific safety requirements and service continuity. Gemini also has flexible measurements, with six different box sizes and internal space to accommodate from 24 to 216 DIN modules.

To respect safety standards, all the switchboard's components can be fixed to the base plate or to the box frame without ha-



1SLC86007F0001

Written in full, its name "Protect IT Multipurpose Box Gemini" says that no switchboard is more reliable. Integration of Gemini with other ABB low voltage protection, monitoring and control products fulfils the objective of offering the market a complete range of products and systems.

In particular, IndustrialIT is the solution ABB has developed for integrating company activities at all levels, in which each product is seen as one element of a single solution. Products and technologies are grouped into functional suites, each of which measures, monitors, optimizes and supports a specific

"block" of activities, interacting in a coordinated manner thanks to the platform created by ABB (AIP: Aspect Integrator Platform).

Not only are all the certified products interactive, but they also ensure that all the information needed to operate them is readily available in the latest edition: technical characteristics, installation, user and maintenance instructions, environmental certificates and declarations.

More information is given in the section entitled Products and services/IndustrialIT on the ABB website www.abb.com

IndustrialIT
enabled™

ving to use any tools; wiring is carried out from the front followed by snapping the base plate or the frame onto the box. The patented frame is fitted with the cable duct incorporated in the uprights.

In its design, Gemini repeats the shapes and RAL 7035 grey color of the ArTu switchboards with which it can be configured as a main protection switchboard.

Experience and innovation

Gemini has two central aspects. It is both the result of years of work in the production of installation material and the expression of the most advanced technology, from design to distribution.

In the laboratory, computer-

aided design programs simulate all types of application conditions translating virtual checks into a process to improve the performances of Gemini so that it will be able to respond more accurately to market requirements.



Index

Basic configuration 2/2
Components for automation applications 2/6
Components for distribution and mixed applications 2/10
Accessories 2/16
Rapid selection table 2/20

base

automation

distribution

accessories



Characteristics



PROTECTION ▶ IP66 (IEC EN 60529)
Class II insulation



STRENGTH ▶ Thermoplastic material moulded in co-injection
Resistance to abnormal heat and fire up to a temperature of 750 °C (IEC EN 60695-2-1)
IK10 (IEC EN 50102) degree of resistance to impacts
Protection against chemical and atmospheric agents (water, saline solutions, acids, basic agents, mineral oils, UV rays)
Operating temperature -25 °C ÷ +100 °C



PERFORMANCE ▶ Rated uninterrupted current up to 400 A
Rated service voltage up to 690 V



FLEXIBILITY OF USE ▶ 6 sizes from 335x400x210 mm to 840x1005x360 mm (WxHxD, external dimensions)
DIN 24 to 216 modules



INSTALLATION-FRIENDLY ▶ Snap-on mounting of all components in compliance with safety Standards



QUALITY AND ENVIRONMENT ▶ Compliance with international reference Standards EN 50298, EN 60670, EN 60439-1
IMQ mark according to Standard EN 50298
100% recyclable



Order codes

Basic configurations

In the basic configuration, Gemini switchboards are composed of boxes in six different sizes ranging from 335x400x210 mm to 840x1005x360 mm (WxHxD, external measurements) and with opaque or transparent doors.

In both versions, the doors are reversible and clip onto the hinges without the need to use

tools; the fact that they open at an angle of more than 180° means that it is easy to work on the components installed inside the switchboard. The seal applied by extrusion along the sides of the doors guarantees IP66 degree of protection. Access to the inside of the switchboard is protected by a standard double bit lock that can be

replaced by locks of another type available in the accessories.

Boxes and doors can be requested either separately or as combined "box + door" codes, to make filling out the order form more flexible.

Inside the packages, the door is always wrapped separately and inserted inside a pocket

that protects it from accidental damage until wiring is completed and the switchboard is installed.

Hole-cover plugs to guarantee IP protection and double insulation for wall mounting are also supplied with the pack together with the instruction sheet.



1SLC88601ZF0001

Gemini doors open at an angle of more than 180° giving easy access to the devices installed inside the switchboard.



1SLC88601ZF0001

No tools are needed for installation. The doors hook onto the hinges with special hinge pins and are reversible.

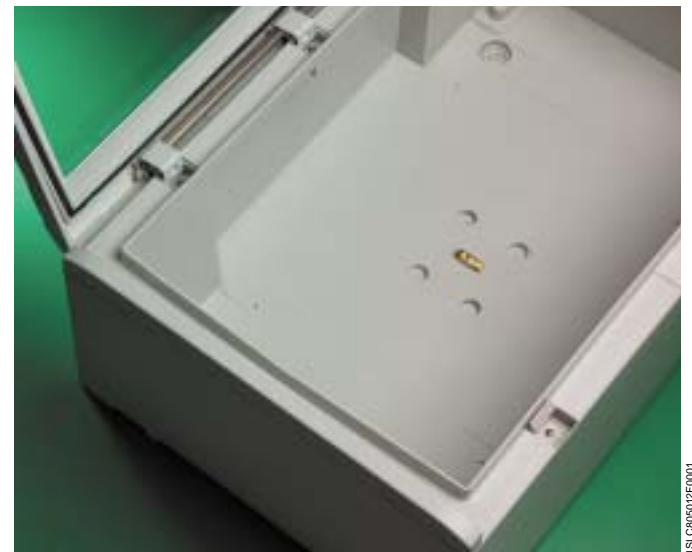

1SLC88601ZF0001

The special structure of the inner perimeter of the box ensures further protection against the penetration of water. The box is supplied with a spirit level.

Order codes

Basic configurations

2



Size	Dimensions	Modules	Codes	Unit/Pack
------	------------	---------	-------	-----------

Boxes and doors

- Available in 6 sizes
- Single order code combined with box and transparent and opaque door
- Pack with door dismounted and wrapped separately
- Door designed so that it can be hooked onto hinges at both vertical sides and mounted without the use of tools
- To be mounted to the wall using internal holes or fixing brackets supplied as accessories
- Door opening at an angle of more than 180°
- RAL 7035 grey color
- Doors supplied with 2 standard double bit locks (3 for sizes 5 and 6) that can be replaced with locks for ciphered key or with square/triangular impression (the standard triplex key is suitable for use with three types of impressions).

	External WxHxD (mm)	Internal WxHxD (mm)	Max no. DIN mod.	No. vertical mod. (H=150 mm)	With transparent door	With opaque door	
1	335x400x210	250x300x180	24 (12x2)	2	1SL0211A00	1SL0201A00	1/1
2	460x550x260	375x450x230	54 (18x3)	3	1SL0212A00	1SL0202A00	1/1
3	460x700x260	375x600x230	72 (18x4)	4	1SL0213A00	1SL0203A00	1/1
4	590x700x260	500x600x230	96 (24x4)	4	1SL0214A00	1SL0204A00	1/1
5	590x855x360	500x750x330	120 (24x5)	5	1SL0215A00	1SL0205A00	1/1
6	840x1005x360	750x900x330	216 (36x6)	6	1SL0216A00	1SL0206A00	1/1

Order codes

Basic configurations

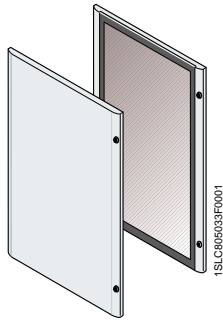
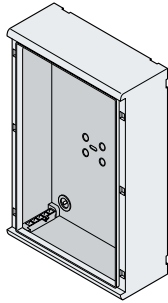

1SLC080533F0001

Size	Internal dimensions	External dimensions	Codes	Unit/Pack
------	---------------------	---------------------	-------	-----------

Single box

	WxHxD (mm)	WxHxD (mm)	Codes	Unit/Pack
1	335x400x210	250x300x180	1SL0221A00	1/1
2	460x550x260	375x450x230	1SL0222A00	1/1
3	460x700x260	375x600x230	1SL0223A00	1/1
4	590x700x260	500x600x230	1SL0224A00	1/1
5	590x855x360	500x750x330	1SL0225A00	1/1
6	840x1005x360	750x900x330	1SL0226A00	1/1

Size	Box dimensions	Codes	Unit/Pack
------	----------------	-------	-----------

Single doors

	WxHxD (mm)	Transparent door	Opaque door	Unit/Pack
1	335x400x210	1SL0241A00	1SL0231A00	1/1
2	460x550x260	1SL0242A00	1SL0232A00	1/1
3	460x700x260	1SL0243A00	1SL0233A00	1/1
4	590x700x260	1SL0244A00	1SL0234A00	1/1
5	590x855x360	1SL0245A00	1SL0235A00	1/1
6	840x1005x360	1SL0246A00	1SL0236A00	1/1

2

base

automation

distribution

accessories



Order codes

Components for automation applications

Gemini switchboards are designed to be perfectly compatible with ABB components for low voltage control and monitoring.

For these applications they can be equipped with modular devices belonging to the System pro *M* range, with Tmax moulded-case circuit-breakers and control and signaling devices, creating a truly integrated automation system.

When deciding the Gemini layout for control and monitoring

applications, not only is it possible to select the box and door in the required size, but you can also select the base plate in one of the three versions in the range.

After wiring with the ducts and the Fix-O-Rapid device, the special standard adjustable feet and hooks must be fitted onto the base plate, allowing it to be inserted inside the box at up to seven different depths and three further levels of adjustment: no tools need to be used

to carry out these operations.

To finish the job, the inner door can be mounted (reversible and in insulating material), guaranteeing IP40 degree of protection when the switchboard door is open.

No tools are needed unless the inner door is equipped with buttons, warning lights, etc.



The fixing hooks and feet supplied in the standard versions are applied without having to use tools, making it possible to install the base plate at seven different depths inside the switchboard. They can also be adjusted at three further positions.

2



Application of the inner door guarantees IP40 degree of protection when the switchboard door is open.



The base plate can be snap-mounted inside the switchboard.



Example of the configuration of a switchboard for an automation application: some ABB control and protection devices are installed on the plate. The inner door is fitted with light-signaling devices.

Order codes

Components for automation applications

2

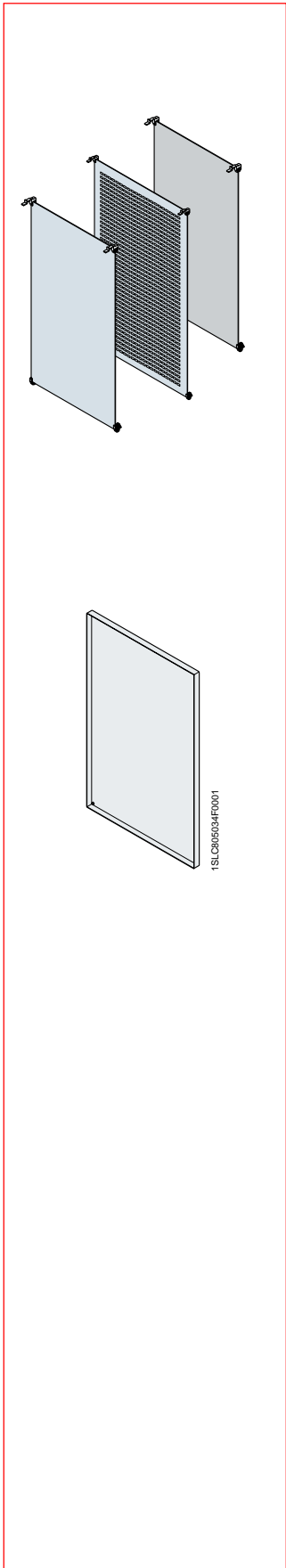

Size of the switchboard	Code	Unit/Pack
-------------------------	------	-----------

Base plates

- Available in three versions in blank or drilled metal and insulating material
- Positioning at 3 different depths for size 1, 4 different depths for sizes 2-3-4 and 7 different depths for sizes 5-6 (adjustments with 30 mm pitch)
- Supplied with feet and hooks adjustable at three further positions (with 7.5 mm pitch)
- Snap-on mounting

	In blank metal	In drilled metal	Insulating material	
1	1SL0259A00	1SL0275A00	1SL0267A00	1/6
2	1SL0260A00	1SL0276A00	1SL0268A00	1/6
3	1SL0261A00	1SL0277A00	1SL0269A00	1/4
4	1SL0262A00	1SL0278A00	1SL0270A00	1/4
5	1SL0263A00	1SL0279A00	1SL0271A00	1/4
6	1SL0264A00	1SL0280A00	1SL0272A00	1/2

Inner doors

- Available for size 2 to size 6 boxes
- Made in insulating material
- IP40 degree of protection with door open
- Designed so that door can be hinged onto both vertical sides
- Snap-on mounting and fixing

1	-	-
2	1SL0252A00	1/4
3	1SL0253A00	1/2
4	1SL0254A00	1/2
5	1SL0255A00	1/2
6	1SL0256A00	1/1

Order codes

Components for automation applications

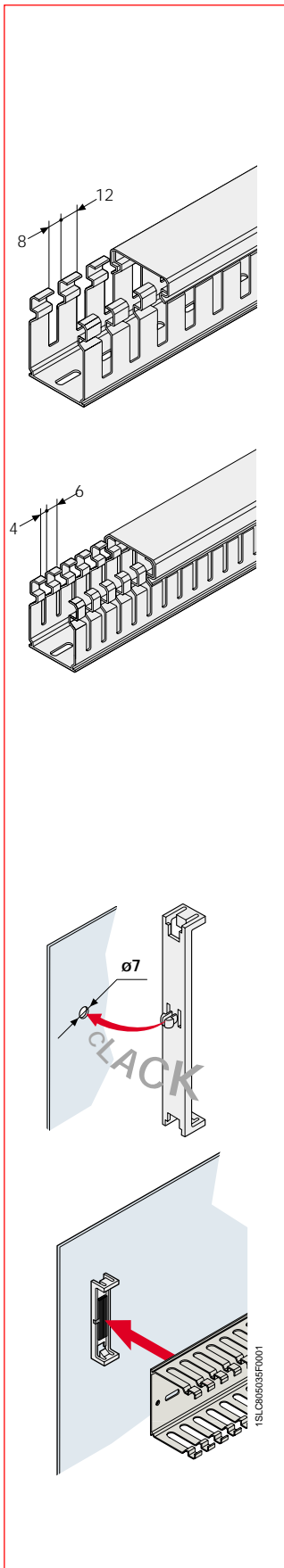

Code	Dimensions	Weight (kg/m)	Unit/Pack-meters
------	------------	---------------	------------------

Wiring ducts

- Made in self-extinguishing thermoplastic material (UL 94 V0), resistant to abnormal heat and fire up to 960 °C (IEC 695-2-1)
- RAL 7035 grey color
- Available in version with 8/12 mm and 4/6 mm slots
- Base strip designed to snap onto Fix-O-Rapid
- Available in standard lengths of 2 m

With 8/12 mm slots	With 4/6 mm slots	WxH (mm)	Weight (kg/m)	Unit/Pack-meters
05 019	05 119	15x17	0.06	46
05 033	05 133	25x30	0.21	58
05 043	05 143	25x40	0.25	48
05 063	05 163	25x60	0.24	34
05 083	05 183	25x80	0.29	28
05 094	05 194	25x100	0.46	20
05 035	05 135	40x30	0.27	40
05 045	05 145	40x40	0.31	30
05 065	05 165	40x60	0.34	22
05 085	05 185	40x80	0.38	36
05 095	05 195	40x100	0.53	28
05 037	05 137	60x30	0.38	52
05 047	05 147	60x40	0.46	40
05 067	05 167	60x60	0.47	32
05 087	05 187	60x80	0.50	24
05 096	05 196	60x100	0.73	20
05 049	05 149	80x40	0.47	32
05 069	05 169	80x60	0.52	24
05 089	05 189	80x80	0.59	16
05 097	05 197	80x100	0.91	14
05 051	05 151	100x40	0.55	24
05 071	05 171	100x60	0.59	20
05 091	05 191	100x80	0.68	16
05 098	05 198	100x100	1.06	8
05 053	05 153	120x40	0.65	20
05 073	05 173	120x60	0.73	14
05 093	05 193	120x80	0.89	12
05 099	05 199	150x100	1.37	8

Code	Description	Unit/Pack-no. pieces
------	-------------	----------------------

Fix-O-Rapid

Rapid mounting device for attaching wiring ducts to the base plate: it snaps onto the plate after drilling a $\varnothing 7$ mm hole. Two Fix-O-Rapid devices are enough for each wiring duct section. Fix-O-Rapid guarantees maximum insulation since it does not involve the use of any metal component inside the wiring duct.

If the wrong wiring duct is selected, it can be dismantled and a version with the same base and a different height can be attached to the Fix-O-Rapid.

05 270	Rapid mounting device for wiring duct, W 25 mm	20/600
05 272	Rapid mounting device for wiring duct, W 40 mm	20/600
05 274	Rapid mounting device for wiring duct, W 60 mm	20/600
05 276	Rapid mounting device for wiring duct, W 80 mm	20/240
05 278	Rapid mounting device for wiring duct, W 100 mm	20/240
05 280	Rapid mounting device for wiring duct, W 120 mm	20/240
05 282	Rapid mounting device for wiring duct, W 150 mm	20/240

base
automation
distribution
accessories



Order codes

Components for distribution and mixed applications

In distribution and mixed applications, the Gemini switchboard is designed to be fitted with System pro *M* modular devices and Tmax moulded-case circuit breakers.

The frame is the load-bearing element of the configuration: DIN rails, partial modular plates and the special Tmax mounting and cabling kits are snapped onto the uprights. All the components can be adjusted to six different depths with a pitch of 12.5 mm and arranged at heights with a distance of 75 mm between the rows.

Blank or drilled front panels are applied to protect the equipment and these can be hinged onto both sides; the cables are housed inside the vertical wiring duct integrated in the uprights according to an exclusive ABB patent.

Wiring is carried out by pulling out the frame and working from the front; the ergonomic grip and the standard feet and snap-on hooks supplied make it easy to insert it inside the switchboard after the job is finished.



The frame can be extracted to make wiring operations easier at the workbench.



The DIN rail is supplied with special hooks already in position for attaching to the uprights.



The depth at which the DIN rail, the modular plates, the kit for fixing the Tmax circuit breakers and the wiring duct are positioned can be adjusted with a simple sliding movement.



Fixing hooks and feet allow the frame to be snap-mounted inside the box.



The blank and drilled panels are hinged onto both sides; the description of the installed components can be kept in the special compartment protected by a transparent, hinged flange.



The upright with the incorporated wiring duct is an exclusive ABB patent that rationalizes the path of cables inside the switchboard.

2

Order codes

Components for distribution and mixed applications

2

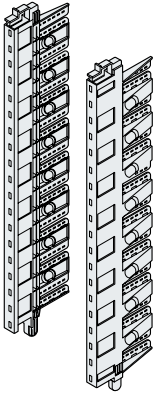

Size of the switchboard	Code	Unit/Pack
-------------------------	------	-----------

Uprights

- Incorporated vertical wiring duct (ABB patent)
- Snap-on mounting of all components (installation pitch of 75 mm)
- Snap-on insertion into box
- Depth of installed components adjusted at a pitch of 12.5 mm (4 positions for uprights of size 1 and 6 positions for the remaining ones)
- Ergonomic grip to make it easy to insert and extract

1	1SL0283A00	1/4
2	1SL0284A00	1/4
3	1SL0285A00	1/4
4	1SL0285A00	1/4
5	1SL0286A00	1/2
6	1SL0287A00	1/1

Size of the switchboard	Modules per row	Code	Unit/Pack
-------------------------	-----------------	------	-----------

DIN rail

- Two-sided version
- Supplied with mounting supports that snap onto uprights
- Depth adjustment on uprights
- Designed so that rapid Unifix L mounting bars can be snapped on

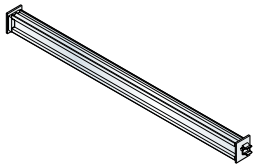

1SL0290A00

1	12	1SL0290A00	1/10
2	18	1SL0291A00	1/10
3	18	1SL0291A00	1/10
4	24	1SL0292A00	1/10
5	24	1SL0292A00	1/10
6	36	1SL0293A00	1/10

Order codes

Components for distribution and mixed applications

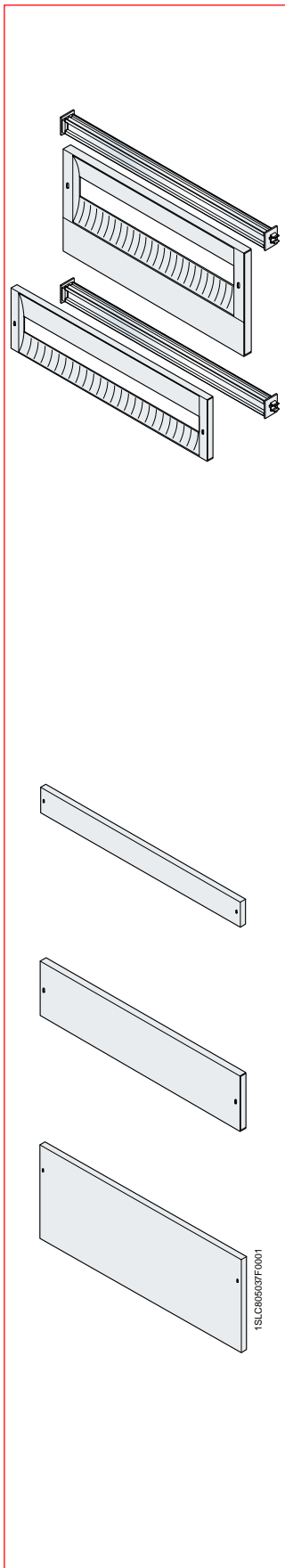

Size of the switchboard	Code	Unit/Pack
-------------------------	------	-----------

Drilled panels

- Supplied with DIN rail complete with supports to snap onto uprights and adjustable in depth
- Available in 1 module (H 150 mm) and 1+1/2 module (H 225 mm, sizes 2-6) dimensions
- Designed to be hinged onto both vertical sides
- Snap-on mounting onto uprights (in compliance with reference Standards a tool must be used for removing the panel)
- Document pocket for storing descriptions of installed devices

	1 module	1 + 1/2 module	
1	1SL0307A00	-	1/8
2	1SL0308A00	1SL0313A00	1/8
3	1SL0308A00	1SL0313A00	1/8
4	1SL0309A00	1SL0314A00	1/4
5	1SL0309A00	1SL0314A00	1/4
6	1SL0310A00	1SL0315A00	1/2

Blank panels

- Available in 1/2 module (H 75 mm), 1 module (H 150 mm) and 2 modules (H 300 mm) dimensions
- H 150 mm and H 300 panels designed to be hinged onto both vertical sides
- Snap-on mounting onto uprights (in compliance with reference Standards a tool must be used for removing the panel)

1/2 module			
1	1SL0318A00		1/10
2	1SL0319A00		1/10
3	1SL0319A00		1/10
4	1SL0320A00		1/6
5	1SL0320A00		1/6
6	1SL0321A00		1/4
1 module			
1	1SL0324A00		1/8
2	1SL0325A00		1/8
3	1SL0325A00		1/8
4	1SL0326A00		1/4
5	1SL0326A00		1/4
6	1SL0327A00		1/4
2 modules			
1	1SL0330A00		1/6
2	1SL0331A00		1/6
3	1SL0331A00		1/6
4	1SL0332A00		1/4
5	1SL0332A00		1/4
6	1SL0333A00		1/4

2

Order codes

Components for distribution and mixed applications

2

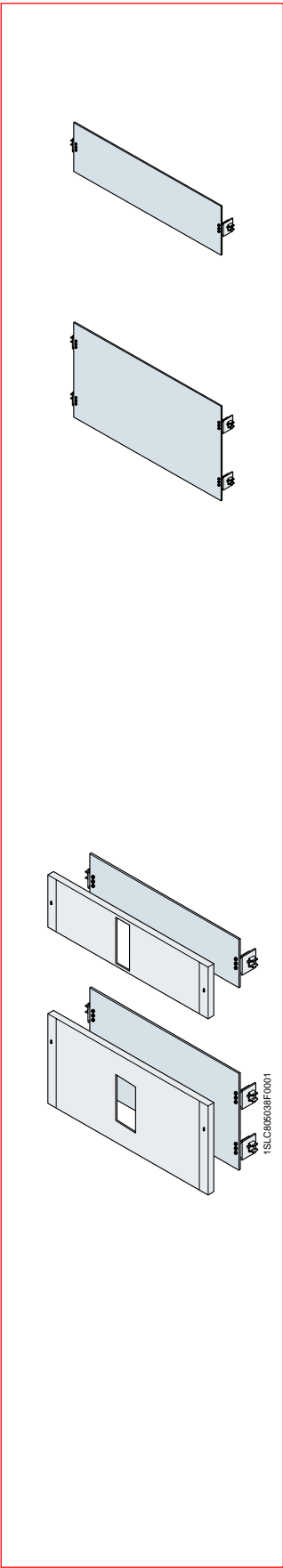

Size of the switchboard	Code	Unit/Pack
-------------------------	------	-----------

Partial modular plates

- Available in 1 module (H 150 mm) and 2 module (H 300 mm, sizes 2-6) dimensions
- Snap-on mounting onto uprights with depth adjustment

1 module		
1	1SL0296A00	1/6
2	1SL0297A00	1/4
3	1SL0297A00	1/4
4	1SL0298A00	1/4
5	1SL0298A00	1/4
6	1SL0299A00	1/2
2 modules		
1	-	-
2	1SL0302A00	1/4
3	1SL0302A00	1/4
4	1SL0303A00	1/4
5	1SL0303A00	1/4
6	1SL0304A00	1/2

Kit for installing Tmax moulded-case circuit breakers

- For installing Tmax moulded-case circuit breakers in fixed version with front terminals
- Composed of a plate with special drilled holes and a protection panel with vertical slots that can be hinged on both sides and snap-on mounted (in compliance with reference Standards a tool must be used for removing the panel)
- Available for sizes 2-6
- Version H 150 with drillings for Tmax T1 3 poles (with and without residual current releaser), Tmax T1 4 poles (with and without residual current releaser), Tmax T2 3 poles (with and without residual current releaser), Tmax T2 4 poles (without residual current releaser)
- Version H 300 with drillings for Tmax T2 4 poles (with residual current releaser), Tmax T3 3 poles (with and without residual current releaser), Tmax T3 4 poles (with and without residual current releaser)
- Snap-on mounting onto uprights with the possibility of adjusting the plate depth

	H 150 mm	H 300 mm	
1	-	-	-
2	1SL0336A00	1SL0370A00	1/4
3	1SL0336A00	1SL0370A00	1/4
4	1SL0337A00	1SL0371A00	1/4
5	1SL0337A00	1SL0371A00	1/4
6	1SL0338A00	1SL0372A00	1/2

When choosing the correct kit, see table on page 3/8.

Order codes

Components for distribution and mixed applications



Size of the switchboard	Code	Unit/Pack
-------------------------	------	-----------

Wiring kit

- Composed of wiring duct in versions 25x60 mm and 40x60 mm (WxH, 8-12 mm slots) and Fix-O-Rapid
- Snap-on mounting on uprights with depth adjustment

	Wiring duct 25x60 mm	Wiring duct 40x60 mm	
1	1SL0353A00	1SL0360A00	1/4
2	1SL0354A00	1SL0361A00	1/4
3	1SL0354A00	1SL0361A00	1/4
4	1SL0355A00	1SL0362A00	1/4
5	1SL0355A00	1SL0362A00	1/4
6	1SL0356A00	1SL0363A00	1/4

base
automation
distribution
accessories



Order codes

Accessories

Gemini switchboards have the same accessories for both automation and distribution applications, ensuring maximum versatility and integration of functions.

In particular, the ventilation and anti-condensation kits make it even safer for the devices to run, protecting them from the effects of heat and humidity while the wall brackets, pole mounting kit

and pedestal make it easier to install the switchboards in any context.

Three different kinds of locks are supplied for the doors with which it is possible to replace the standard double bit model. The universal drill bit can be used to open the side branch connections. Module covers hide the unused modules of the DIN rail guaranteeing IP40 protection

when the door is open in distribution and mixed configurations.



1SLC865027F0001



1SLC865028F0001

Gemini wall-mounted installation using the special mounting brackets.

2



1SLC865029F0001



1SLC865065F0001

The standard locks supplied can be replaced by the version with ciphered key and handle or with square or triangular impression.



1SLC865066F0001

The fact that Gemini switchboards can also be pole-mounted (see photo above) or mounted on a special pedestal (see photo at the side) makes them suitable for any application situation.

Order codes

Accessories

2

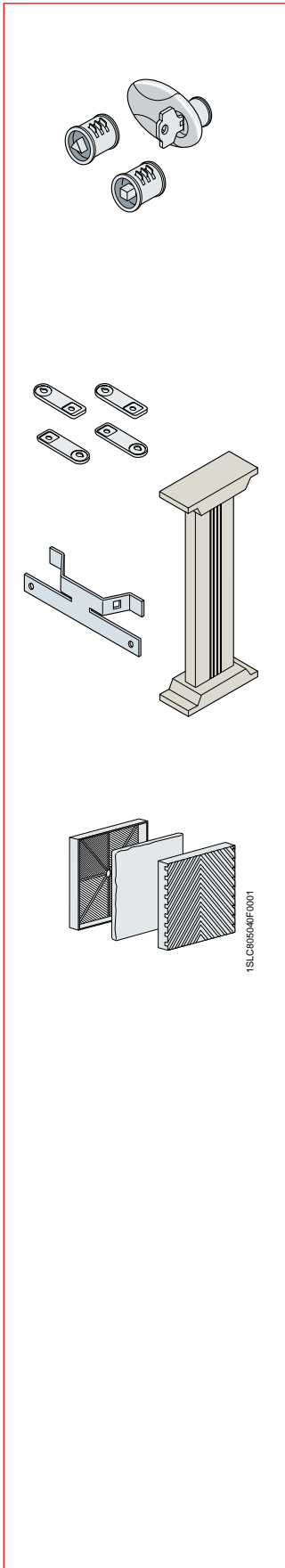

Code	Description	Unit/Pack
------	-------------	-----------

Locks

- Available in three versions with ciphered key and handle, with triangular and square impressions

1SL0340A00	Lock with Yale type ciphered key and handle	1/10
1SL0341A00	Lock with triangular impression	1/10
1SL0339A00	Lock with square impression	1/10

Mounting elements

- Guarantee optimum wall, pole and floor mounting conditions

1SL0342A00	Horizontal and vertical wall brackets	1/10
1SL0343A00	Pole mounting kit for sizes 1 switchboards	1/4
1SL0344A00	Pole mounting kit for sizes 2-3 switchboards	1/4
1SL0345A00	Pole mounting kit for sizes 4-5 switchboards	1/2
1SL0346A00	Pole mounting kit for size 6 switchboards	1/2
1SL0352A00	Floor mounting pedestal for sizes 1-4	1/1

Ventilation kit

- Composed of plastic grills and filter to ensure switchboard ventilation
- IP42
- The filter must be cleaned periodically

1SL0350A00	Ventilation kit	1/1
------------	-----------------	-----

Order codes

Accessories

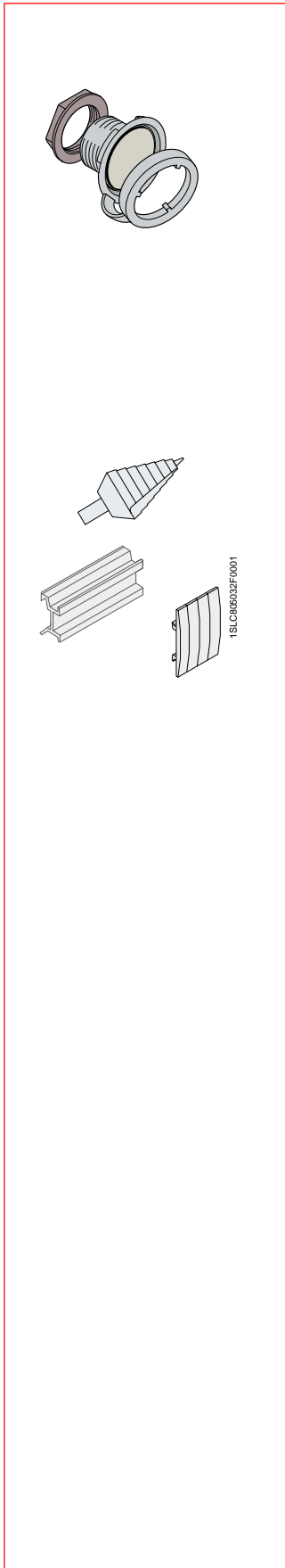

Code	Description	Unit/Pack
------	-------------	-----------

Anti-condensation kit

- Kit in special material to prevent condensation from forming inside the switchboard: it include **Gore™ MEMBRANE VENTING**
- Impermeable to water (pressure): 1 bar
- Air flow: 68/h (dp = 70 mbar)
- 1 kit for sizes 1-2, 2 kits for sizes 3-4 and 3 kits for sizes 5-6 are recommended to guarantee adequate dissipation; in any case the number of kits to be installed depend on the number and type of devices installed inside the switchboard.

1SL0351A00	Anti-condensation kit	1/6
------------	-----------------------	-----

Other accessories

12894	Universal drill bit	1/30
12863	Module covers in RAL 7035 grey, 4 modules	50/600
12851	Plastic spacer for installing modular devices and moulded-case circuit breakers at the same depth	10/60

Order codes

Rapid selection table

Basic configuration

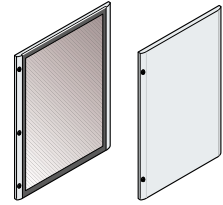
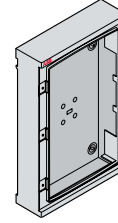
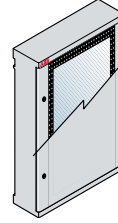
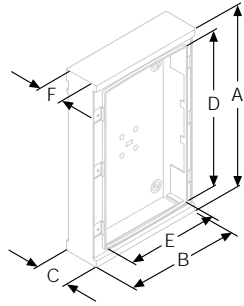

2

Size	No. of installable DIN modules (mod. x row)	No. of vertical mod. (H=150 mm)	External dimensions			Internal dimensions			Complete switchboard		Box	Door	
			A	B	C	D	E	F	Transparent door	Opaque door	Transparent	Opaque	
1	24 (12x2)	2	400	335	210	300	250	180	1SL0211A00	1SL0201A00	1SL0221A00	1SL0241A00	1SL0231A00
2	54 (18x3)	3	550	460	260	450	375	230	1SL0212A00	1SL0202A00	1SL0222A00	1SL0242A00	1SL0232A00
3	72 (18x4)	4	700	460	260	600	375	230	1SL0213A00	1SL0203A00	1SL0223A00	1SL0243A00	1SL0233A00
4	96 (24x4)	4	700	590	260	600	500	230	1SL0214A00	1SL0204A00	1SL0224A00	1SL0244A00	1SL0234A00
5	120 (24x5)	5	855	590	360	750	500	330	1SL0215A00	1SL0205A00	1SL0225A00	1SL0245A00	1SL0235A00
6	216 (36x6)	6	1005	840	360	900	750	330	1SL0216A00	1SL0206A00	1SL0226A00	1SL0246A00	1SL0236A00

Accessories common to the whole range

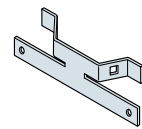
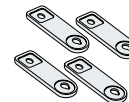
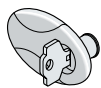

Size	Lock with handle	Lock with triangular impression	Lock with square impression	Installation brackets	Pole installation kit
1	1SL0340A00	1SL0341A00	1SL0339A00	1SL0342A00	1SL0343A00
2					1SL0344A00
3					1SL0344A00
4					1SL0345A00
5					1SL0345A00
6					1SL0346A00

Order codes

Rapid selection table

Components for automation

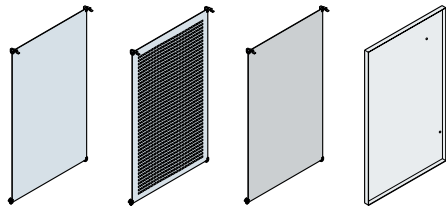

Blank	Drilled	Insulating	Inner door
1SL0259A00	1SL0275A00	1SL0267A00	-
1SL0260A00	1SL0276A00	1SL0268A00	1SL0252A00
1SL0261A00	1SL0277A00	1SL0269A00	1SL0253A00
1SL0262A00	1SL0278A00	1SL0270A00	1SL0254A00
1SL0263A00	1SL0279A00	1SL0271A00	1SL0255A00
1SL0264A00	1SL0280A00	1SL0272A00	1SL0256A00

Accessories for automation

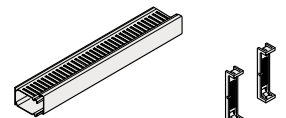

Size	Wiring ducts	Fix-O-Rapid
1	See page 2/9	See page 2/9
2		
3		
4		
5		
6		

Components for distribution

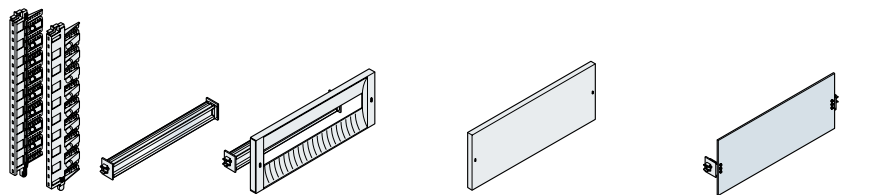

Uprights	DIN rail	Drilled panel		Blank panel			Modular plate	
		H=150 mm	H=225 mm	H=75 mm	H=150mm	H=300 mm	H=150 mm	H=300 mm
1SL0283A00	1SL0290A00	1SL0307A00	-	1SL0318A00	1SL0324A00	1SL0330A00	1SL0296A00	-
1SL0284A00	1SL0291A00	1SL0308A00	1SL0313A00	1SL0319A00	1SL0325A00	1SL0331A00	1SL0297A00	1SL0302A00
1SL0285A00	1SL0291A00	1SL0308A00	1SL0313A00	1SL0319A00	1SL0325A00	1SL0331A00	1SL0297A00	1SL0302A00
1SL0285A00	1SL0292A00	1SL0309A00	1SL0314A00	1SL0320A00	1SL0326A00	1SL0332A00	1SL0298A00	1SL0303A00
1SL0286A00	1SL0292A00	1SL0309A00	1SL0314A00	1SL0320A00	1SL0326A00	1SL0332A00	1SL0298A00	1SL0303A00
1SL0287A00	1SL0293A00	1SL0310A00	1SL0315A00	1SL0321A00	1SL0327A00	1SL0333A00	1SL0299A00	1SL0304A00

Accessories for distribution

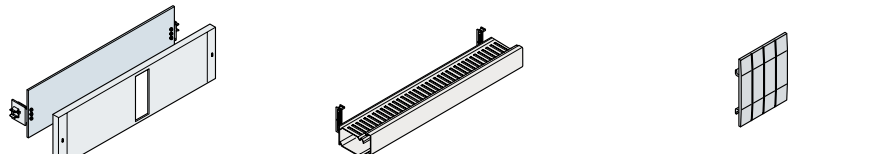

Kit for Tmax		Fix-O-Rapid kit with wiring duct		Module covers RAL 7035
H=150 mm	H= 300 mm	25x60 mm	40x60 mm	
-	-	1SL0353A00	1SL0360A00	12863
1SL0336A00	1SL0370A00	1SL0354A00	1SL0361A00	
1SL0336A00	1SL0370A00	1SL0354A00	1SL0361A00	
1SL0337A00	1SL0371A00	1SL0355A00	1SL0362A00	
1SL0337A00	1SL0371A00	1SL0355A00	1SL0362A00	
1SL0338A00	1SL0372A00	1SL0356A00	1SL0363A00	

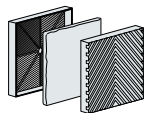

Ventilation kit

1SL0350A00



Anti-condensation kit

1SL0351A00

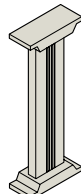

Pedestal

1SL0352A00

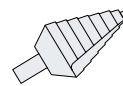

Universal drill bit

12894

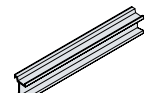

Depth adapter

12851



Index

Compliance with Standards and technical characteristics	3/2
IP degree of protection	3/4
IK degree of resistance to impacts	3/5
Double insulation	3/6
Self-extinguishing tests	3/6
Resistance to chemical agents	3/7
Installation of Tmax moulded-case circuit breakers	3/8
Unifix L fast wiring system	3/9
Entrelec connection system	3/10
Examples of orders	3/12
Component mounting distances	3/15
Disposal instructions	3/17

Technical information

Compliance with Standards and technical characteristics

Reference Standards

Standard CEI EN 50298 ("Empty enclosures for low voltage switch-gear and control gear assemblies. General requirements.") is the prescriptive reference for Gemini switchboards.

The object of Standard CEI EN 50298 is to formulate definitions, classifications, characteristics and test prescriptions for cases designed to be used as part of protection and operating equipment (switchboards) in compliance with the Standards of the EN 60439 series, that have a maximum rated voltage of 1000 V in alternating current for maximum frequencies of 1000 Hz or 1500 V in direct current and are suitable for general use in both internal and external applications. The Standard applies to empty enclosures, before the user has installed protection and operating devices inside them.

The Standard does not apply to enclosures with structural and functional characteristics that make them subject to other prescriptions (e.g. cases for domestic installations and the like). In this case Standards IEC 60670 – CEI 23-48 ("General requirements for enclosures for accessories for household and similar fixed electrical installations") and CEI 23-49 ("Enclosures for accessories for household and similar fixed electrical installations. Part 2: particular requirements for enclosures for protection devices and accessories dissipating a considerable power in normal use") apply.

On the basis of the indications of the ABB SACE technical characteristics' table, the installer may have to certify compliance with Standards CEI 23-51 – EN 60439-1 – CEI 17-13-1 ("Part 1: standard equipment subject to type tests – AS – and non-standard equipment partially subject to type tests – ANS).

Technical information

Technical characteristics

Table of Gemini switchboards' technical characteristics

Size	1	2	3	4	5	6
Gemini with transparent door	1SL0211A00	1SL0212A00	1SL0213A00	1SL0214A00	1SL0215A00	1SL0216A00
Gemini with opaque door	1SL0201A00	1SL0202A00	1SL0203A00	1SL0204A00	1SL0205A00	1SL0206A00
External dimensions WxHxD (mm)	335x400x210	460x550x260	460x700x260	590x700x260	590x855x360	840x1005x360
Internal dimensions WxHxD (mm)	250x300x180	375x450x230	375x600x230	500x600x230	500x750x330	750x900x330
IP degree	IP66	IP66	IP66	IP66	IP66	IP66
Double isolation	Yes	Yes	Yes	Yes	Yes	Yes
IK degree	10	10	10	10	10	10
GWT (°C)	750	750	750	750	750	750
Operating temperature	-25 °C ÷ +100 °C	-25 °C ÷ +100 °C	-25 °C ÷ +100 °C	-25 °C ÷ +100 °C	-25 °C ÷ +100 °C	-25 °C ÷ +100 °C
No. of DIN modules	24 (12x2)	54 (18x3)	72 (18x4)	96 (24x4)	120 (24x5)	216 (36x6)
No. of vertical modules (H=150 mm)	2	3	4	4	5	6
Material	Thermoplastic	Thermoplastic	Thermoplastic	Thermoplastic	Thermoplastic	Thermoplastic
Color	Grey RAL7035	Grey RAL7035	Grey RAL7035	Grey RAL7035	Grey RAL7035	Grey RAL7035
Fast wiring system	Unifix L	Unifix L	Unifix L	Unifix L	Unifix L	Unifix L
No. of locks	2	2	2	2	3	3
Rated current I_n	≤ 400 A	≤ 400 A	≤ 400 A	≤ 400 A	≤ 400 A	≤ 400 A
Rated frequency	50-60 Hz	50-60 Hz	50-60 Hz	50-60 Hz	50-60 Hz	50-60 Hz
Maximum dissipation power ⁽¹⁾	45 W	72 W	85 W	102 W	156 W	248 W
STANDARD CEI EN 60439-1						
Over-temperature (par. 8.2.1) ⁽²⁾						
- Max. dispersible power with over-temperature of 25 °C	40 W	65 W	77 W	91 W	133 W	205 W
- Max. dispersible power with over-temperature of 30 °C	45 W	72 W	85 W	102 W	156 W	248 W
- Max. dispersible power with over-temperature of 35 °C	52 W	85 W	100 W	121 W	187 W	299 W
- Max. dispersible power with over-temperature of 40 °C	62 W	100 W	118 W	143 W	221 W	355 W
Impulse withstand (par. 8.2.2)						
- Rated service voltage	≤ 690 V	≤ 690 V	≤ 690 V	≤ 690 V	≤ 690 V	≤ 690 V
- Rated insulation voltage	≤ 800 V	≤ 800 V	≤ 800 V	≤ 800 V	≤ 800 V	≤ 800 V
- Rated impulse withstand voltage	8 kV	8 kV	8 kV	8 kV	8 kV	8 kV
Short circuit withstand (par. 8.2.3)						
- Rated peak short-circuit current	-	-	-	-	-	-

⁽¹⁾ Maximum dissipation power data was obtained following the indications of **Standard CEI 23-49**, with a temperature difference of $\Delta t=30$ °C.

⁽²⁾ **Note to paragraph 8.2.1 of Standard CEI EN 60439-1**

The table gives the thermal dissipation values of Gemini switchboards when they are wall-mounted. The dispersible power figures (in Watts) vary according to the overtemperature allowed in the accessible parts of the switchboard and must be compared with the total amount of power dissipated by all the components installed inside the switchboard taking into due account the factor of contemporaneity.

Technical information

IP degree of protection

IP degree of protection

As indicated in the following table, the IP degree of protection is expressed by two characteristic numbers depending on the behavior of the product to which it refers according to the prescriptions

of CEI 70-1 and IEC 529 Standards.

With IP66 degree of protection, Gemini switchboards are totally protected against the penetration of dusts and sprays of seawater.



First number: protection against the penetration of solid bodies

Second number: protection against the penetration of water

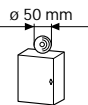
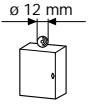
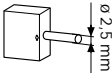
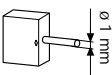
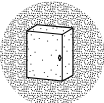
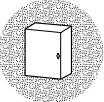
3

IP		
0		No protection
1		Protection against the penetration of solid bodies with a diameter of over 50 mm
2		Protection against the penetration of solid bodies with a diameter of over 12 mm or a length of over 80 mm
3		Protection against the penetration of solid bodies with a diameter or thickness of over 2.5 mm
4		Protection against the penetration of solid bodies with a diameter or thickness of over 1.0 mm
5		Protection against the penetration of dusts
6		Total protection against the penetration of dusts

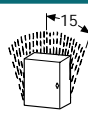
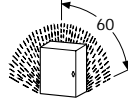
1st number defined by Standards CEI 70-1 – IEC 60529

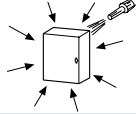
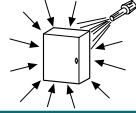
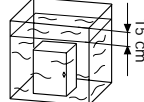
IP		
0		No protection
1		Protection against the penetration of drops of water falling vertically
2		Protection against the penetration of drops of water falling at an angle of up to 15° from vertical
3		Protection against the penetration of drops of water falling at an angle of up to 60° from vertical
4		Protection against the penetration of splashes of water from all directions
5		Protection against the penetration of water sprayed by a hose from all directions
6		Protection against the penetration of sea water
7		Protection against the penetration of water during temporary immersion
8		Protection against the penetration of water during continual immersion

2nd number defined by Standards CEI 70-1 - IEC 60529

1SLC806041F0001

Technical information

IK degree of resistance to impacts

IK degree of resistance to impacts

The IK degree is expressed in Joules in compliance with Standard CEI EN 50102.

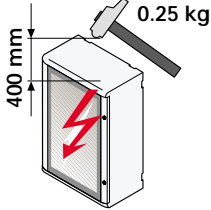
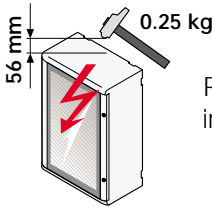
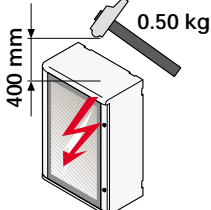
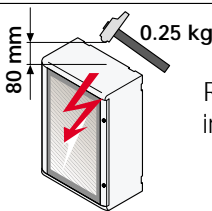
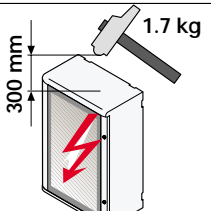
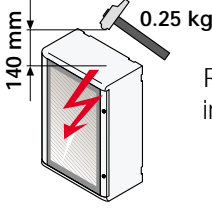
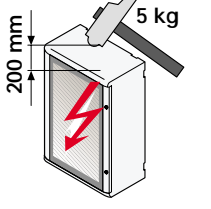
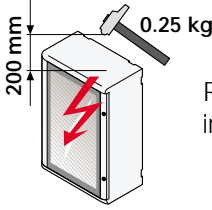
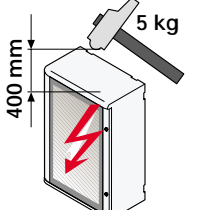
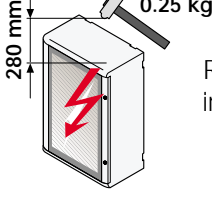
IK 00	 <p>No protection against impacts</p>	IK 06	 <p>Resistance to impacts with impact energy up to 1.00 J</p>
IK 01	 <p>Resistance to impacts with impact energy up to 0.150 J</p>	IK 07	 <p>Resistance to impacts with impact energy up to 2.00 J</p>
IK 02	 <p>Resistance to impacts with impact energy up to 0.200 J</p>	IK 08	 <p>Resistance to impacts with impact energy up to 5.00 J</p>
IK 03	 <p>Resistance to impacts with impact energy up to 0.350 J</p>	IK 09	 <p>Resistance to impacts with impact energy up to 10.00 J</p>
IK 04	 <p>Resistance to impacts with impact energy up to 0.500 J</p>	IK 10	 <p>Resistance to impacts with impact energy up to 20.00 J</p>
IK 05	 <p>Resistance to impacts with impact energy up to 0.700 J</p>		

Technical information

Double insulation and self-extinguishing tests

Double insulation

Double insulation guarantees that Gemini is protected against indirect contacts on condition that the manufacturer's instructions are observed when carrying out mounting and wiring operations on the switchboard and that the appropriate accessories are used (e.g. screw-cover caps).

Double insulation is indicated by the graphic symbol 

Self-extinguishing tests

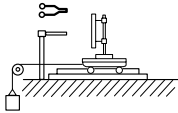
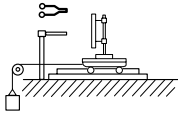
Test text	Equipment required	Compliance with Standards	Purpose of the test	Test results	Test conditions		
					Heat source	Length of test	Characteristic elements
GLOW-WIRE TEST 		IEC 695-2-1 CEI 50-11	To assess the danger of fire by simulating thermal stresses produced by heat sources or by ignition (e.g. glowing elements, resistances overloaded for short intervals)	If a flame is generated, it must go out within 30 seconds of removing the glow wire. The test is conducted at temperatures of: - 650 °C - 750 °C - 850 °C - 960 °C	Glow wire ø 4 mm	30 sec.	Assessment of the time it takes for the flame to go out

■	Cold wa
■	Hot wa
■	Sulfuri
■	Hydro
■	Acetic
▶	Benzol
▶	Gasoli
■	Aceton
■	Ethyl a
■	Ammon
▶	Dichlor
▶	Diesel
■	Minera
■	Food o
▶	Perchl
▶	Trichlo
■	Ethylet
▶	Toluen
■	Methan
■	Wine
■	Fruit ju
■	Laund
■	Deterg

1SLC805004F0201



Technical information

Integration with ABB products

Installation of Tmax moulded-case circuit breakers

The table indicates the type of installation required for the different versions of Tmax moulded-case circuit breakers in Gemini switchboards.

Before carrying out wiring operations check compliance with Standards on the basis of the technical characteristics of the switchboard and circuit breaker (CEI EN 60439-1).

Size	Installation	Tmax T1	Tmax T2	Tmax T3	Tmax T4	Tmax T5
1	D	•	•	•		
	O1	•	•			
	T	•	•	•	• (3)	• (3)
2	D	•	•	•		
	K1	•	• (1)			
	K2		• (2)	•		
	O1	•	•	•	• (4)	
	O2	•	•	•	•	• (3)
	T	•	•	•	•	•
3	D	•	•	•		
	K1	•	• (1)			
	K2		• (2)	•		
	O1	•	•	•	• (4)	
	O2	•	•	•	•	• (3)
	T	•	•	•	•	•
4	D	•	•	•		
	K1	•	• (1)			
	K2		• (2)	•		
	O1	•	•	•	• (4)	
	O2	•	•	•	•	•
	T	•	•	•	•	•
5	D	•	•	•		
	K1	•	• (1)			
	K2		• (2)	•		
	O1	•	•	•	• (4)	
	O2	•	•	•	•	•
	T	•	•	•	•	•
6	D	•	•	•		
	K1	•	• (1)			
	K2		• (2)	•		
	O1	•	•	•	• (4)	
	O2	•	•	•	•	•
	T	•	•	•	•	•

Caption

- **D**, installation on DIN rail
- **K1**, installation with Tmax kit H = 150 (holes made)
- **K2**, installation with Tmax kit H = 300 (holes made)
- **O1**, installation on modular plate (1 module, H = 150 mm)
- **O2**, installation on modular plate (2 modules, H = 300 mm)
- **T**, installation on total base plate
- • (1), Tmax T2 3 poles (with or without residual current release) and Tmax T2 4 poles (without residual current release)
- • (2), Tmax T2 4 poles (with residual current release)
- • (3), only version without residual current release
- • (4), only version with 3 poles

Technical information

Integration with ABB products

Unifix L fast wiring system

Unifix is the system patented by ABB for the fast and safe wiring of equipment in the System pro *M* range and Tmax and Isomax moulded-case circuit breakers. It is available in three versions, of which Unifix L is the one most suitable for installing in Gemini switchboards with rated currents of up to 100 A and short-circuit currents of up to 25 kA.

Unifix L is composed by assembling its components listed in the following tables that should be referred to when ordering.

The busbars are housed in a system of ducts with a capacity of 100 A and short-circuit current of 25 kA. They are supplied in two and four-pole versions with from 12 to 32 modules. They snap onto the back of the DIN rail.

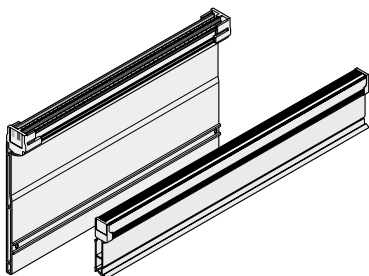

Code	Description	Pack/Pieces
ED2993	Busbar 100 A, 2 poles, 12 modules	1/6
ED3009	Busbar 100 A, 2 poles, 18 modules	1/6
ED3017	Busbar 100 A, 2 poles, 24 modules	1/6
ED3025	Busbar 100 A, 2 poles, 36 modules	1/6
ED2944	Busbar 100 A, 4 poles, 12 modules	1/6
ED2951	Busbar 100 A, 2 poles, 18 modules	1/6
ED2969	Busbar 100 A, 4 poles, 24 modules	1/6
ED2977	Busbar 100 A, 4 poles, 36 modules	1/6

Connections are made in copper, cut to size and bent to allow power supply between the terminals of the modular System pro *M* devices and the Unifix system busbars. They are supplied in the versions L1, L2, L3, N and 1p+N depending on the polarity of the device to be wired.

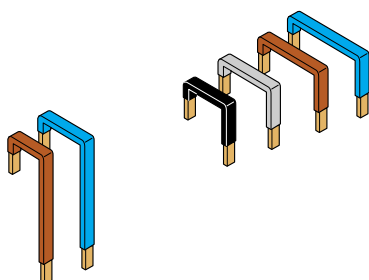

Code	Description	Pack/Pieces
ED3355	Connections with 2 cables, 40 A	1/6
ED3363	Connections with 3 cables, 40 A	1/6
ED3371	Connections with 4 cables, 40 A	1/6
ED3074	Connections 1P+N, 40 A, for DS 121, 1 mod.	1/10
ED3272	Connections L1-N, 40 A, for S9..1N with neutral on the right	1/10
ED3280	Connections L2-N, 40 A, for S9..1N with neutral on the right	1/10
ED3298	Connections L3-N, 40 A, for S9..1N with neutral on the right	1/10
ED3033	Connections L1, 100 A	1/10
ED3041	Connections L2, 100 A	1/10
ED3058	Connections L3, 100 A	1/10
ED3066	Connections N, 100 A	1/10

Feeder modular devices are available with and without cable. Modular devices with cable have a capacity of 36 A and 2-module dimensions; they are supplied in two and four pole versions. Modular devices with cable have a capacity of 100 A and 1-module dimensions; they are supplied in the L1, L2, L3 and N version. Both modular devices connect to the conductors feeding the busbars directly when installation of the main line switch is not envisaged.

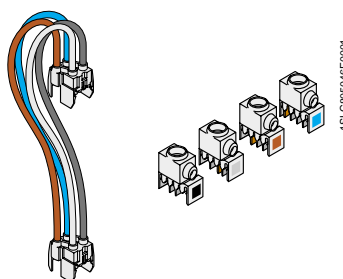

Code	Description	Pack/Pieces
ED3082	Feeder modular device with cable, 63 A, 2 poles, L 250 mm	1/6
ED3090	Feeder modular device with cable, 63 A, 4 poles, L 250 mm	1/6
ED3405	Feeder modular device with cable, 63 A, 4 poles, L 400 mm	1/6
ED3413	Feeder modular device with cable, 63 A, 4 poles, L 800 mm	1/6
ED3439	Feeder modular device with cable, 63 A, 4 poles, L 1500 mm	1/6
ED3101	Feeder modular device without cable, 100 A, L1	1/10
ED3102	Feeder modular device without cable, 100 A, L2	1/10
ED3103	Feeder modular device without cable, 100 A, L3	1/10
ED3104	Feeder modular device without cable, 100 A, N	1/10

Uni-polar feed terminals are available in 63 A and 100 A versions. They connect directly to the front terminals on the modular circuit breakers feeding the busbars through the main line switch. They are designed for the connection of a conductor with a 32 mm² and 25 mm² section respectively

Code	Description	Pack/Pieces
ED3100	Terminals for 100 A feed for 35 mm ² cable	1/10
ED3140	Terminals for 63 A feed for 25 mm ² cable	1/10

Technical information

Integration with ABB products

Electrical connection systems

entrelec[®]

Member of ABB Group

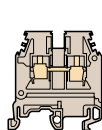

MA 2,5/5

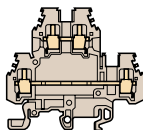

MA 2,5/5.D2

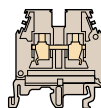

M 4/6



MS 4/6

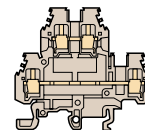



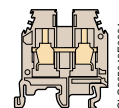









M 4/6.D2



M 6/8

1SLC06647F0001

	MA 2,5/5	MA 2,5/5.D2	M 4/6	MS 4/6	M 4/6.D2	M 6/8
Pitch (mm)	5	5	6	6	6	8
Maximum section (mm ²)	2,5	2,5	4	4	4	6
Connection 	0115 486.03	0115 490.13	0115 116.07	0115 265.24	0115 271.22	0115 118.11
Neutral 	0125 486.05	0125 490.15	0125 116.01	0125 265.26	0125 126.03	0125 118.13
Protection 	0165 488.27	-	0165 113.16	-	-	0165 114.17
Term. Plate 	0118 368.16	0118 499.23	0118 368.16	0113 885.01	0118 499.23	0118 368.16
Head separator 	0116 728.25	0116 720.21	0113 003.10	-	0113 482.05	0113 003.10
Test plug ø 2 mm 	0163 046.24	0164 950.00	0163 043.21	-	0163 070.00	0163 043.21
Control device	0105 028.21	0173 058.02	0173 059.03	0173 059.03	0163 218.05	0173 060.00
Colour						
Test plug ø 2 mm 	0007 865.26	0007 865.26	0007 865.26	0007 865.26	0007 865.26	0007 865.26
IP20 inter. bar 10 poles 	0176 282.23	0176 740.11	0176 667.04	-	0179 672.21	0176 673.02
IP20 inter. bar without screw 10 poles 	0199 443.24	-	0299 702.14	-	-	0299 720.11
Protection plate 	-	-	0163 427.17 0163 433.15	-	-	0163 428.20 0163 433.15
Combs 10 poles 	0113 544.12	0113 544.12	0113 548.26	0113 548.26	0163 311.22	0163 313.24
Shielding bar 	0178 745.14	0173 530.24	0178 745.14	-	-	-

1SLC06647F0001

Technical information

Integration with ABB products

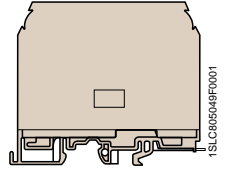
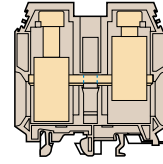
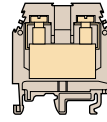
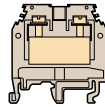
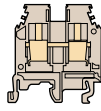
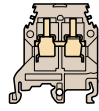
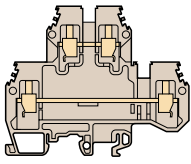

M 6/8.D2	MS 6/8	M 10/10	M 16/12	M 35/16	M 70/22	M 95/26
8	8	10	12	16	22	26
6	6	10	16	35	70	95
0115 501.12	0115 278.01	0115 120.17	0115 129.14	0115 124.07	0115 216.13	0115 556.10
-	0125 278.03	0125 120.11	0125 129.16	0125 124.01	0125 126.15	0125 556.12
-	-	0165 115.10	0165 130.23	0165 111.14	0165 596.13 without rail	0165 556.22 without rail
0116 656.25	0114 195.06	0118 368.16	0118 618.01	0118 233.27	0113 065.15	-
0113 482.05	-	0113 003.10	0113 102.10 terminal plate separat.	-	0113 851.16 terminal plate separat.	-
0163 043.21	-	0163 043.21	0163 043.21	0168 237.05 ø 4mm	-	-
-	0173 060.00	-	-	-	-	-
0007 865.26	0007 865.26	0007 865.26	0007 865.26	0167 860.01 ø 4mm	-	-
0176 673.02	-	0176 679.10	0179 631.03	0179 617.05 no IP20	-	-
0299 720.11	-	-	-	-	-	-
-	-	0163 429.21 0163 433.15	0163 430.26 0163 432.14	0163 431.13 0173 147.20	0173 328.05 0173 323.20	-
-	0163 313.24	0163 315.26	-	-	-	-
-	-	-	-	-	-	-

Technical information

Examples of orders

Examples of orders

The selection of components for the configuration of Gemini switchboards depends on the space available and the type of application. Two examples for each size are given below.

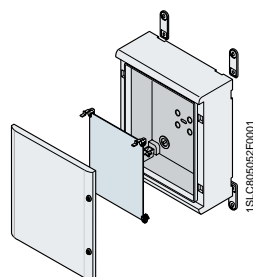
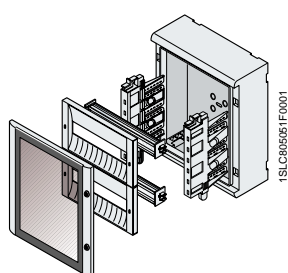

Size 1

	Distribution		Automation
1SL0211A00	Box + transparent door	1SL0201A00	Box + opaque door
1SL0283A00	Uprights	1SL0259A00	Metal base plate
1SL0307A00 (x2)	1-mod. drilled panel + DIN rail	1SL0342A00	Wall-mounting brackets

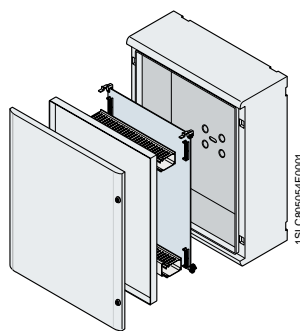
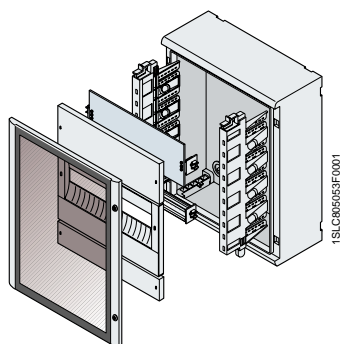

Size 2

	Distribution/Mixed		Automation
1SL0212A00	Box + transparent door	1SL0202A00	Box + opaque door
1SL0284A00	Uprights	1SL0260A00	Metal base plate
1SL0297A00	Modular plate 1 mod.	1SL0252A00	Inner door
1SL0325A00	Blank panel 1 mod.	Vedi pag. 2/9	Wiring duct
1SL0313A00	Drilled panel 1+1/2 mod. + DIN rail	Vedi pag. 2/9	Fix-O-Rapid
1SL0319A00	Blank panel 1/2 mod.		
12863	Module covers		

Technical information

Examples of orders

3

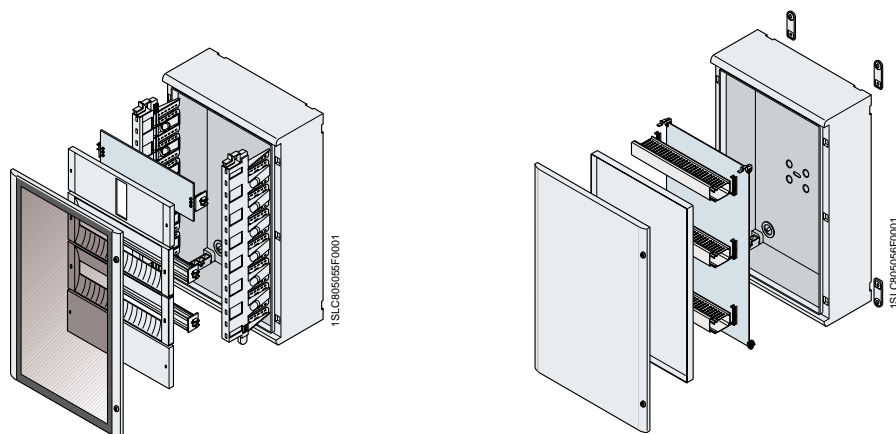

Size 3

	Distribution/Mixed		Automation
1SL0213A00	Box + transparent door	1SL0203A00	Box + opaque door
1SL0285A00	Uprights	1SL0269A00	Base insulating plate
1SL0336A00	Kit for Tmax	1SL0253A00	Inner door
1SL0308A00 (x2)	Drilled panel 1 mod. + DIN rail	See page 2/9	Wiring duct
1SL0291A00	DIN rail	See page 2/9	Fix-O-Rapid
1SL0325A00	Blank panel 1 mod.	1SL0342A00	Wall-mounting brackets
See pages 3/10-3/11	Entrelec terminals		

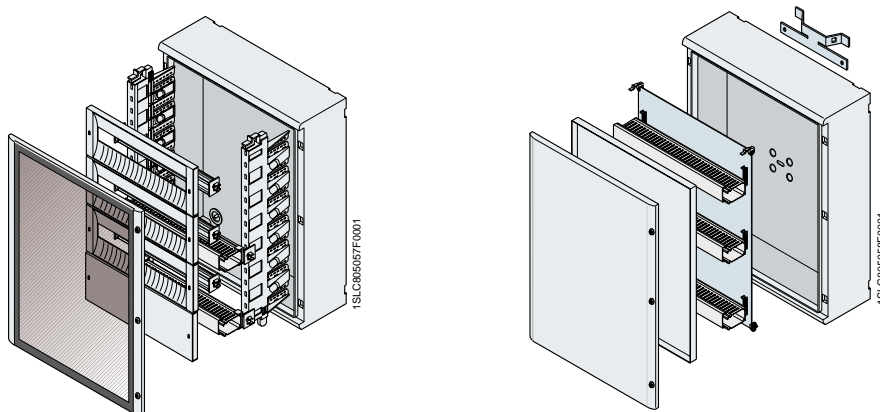

Size 4

	Distribution/Mixed		Automation
1SL0214A00	Box + transparent door	1SL0204A00	Box + opaque door
1SL0285A00	Uprights	1SL0262A00	Metal base plate
1SL0309A00 (x3)	Drilled panel 1 mod. + DIN rail	1SL0254A00	Inner door
1SL0326A00	Blank panel 1 mod.	See page 2/9	Wiring duct
1SL0355A00 (x2)	Wiring kit 25x60 mm	See page 2/9	Fix-O-Rapid
1SL0292A00	DIN rail	1SL0345A00	Fixing on pole kit
12863	Module covers		
Vedi pagg. 3/10-3/11	Entrelec terminals		

Technical information

Examples of orders

3

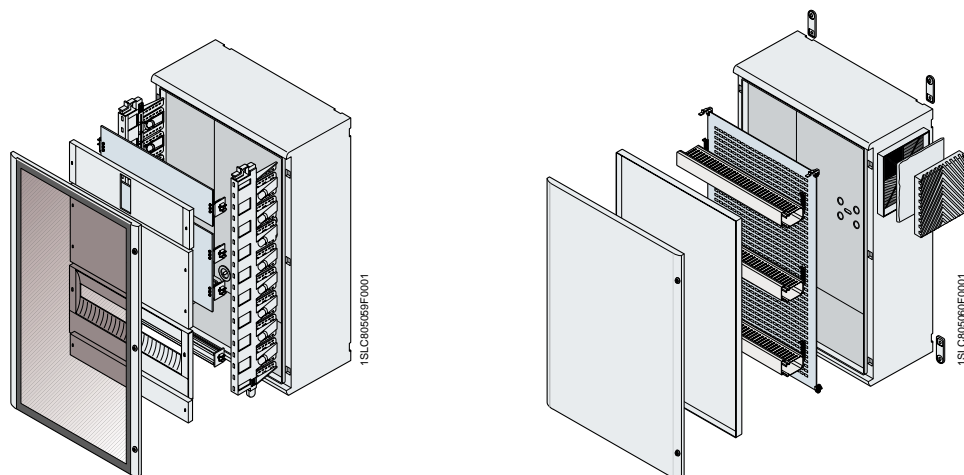

Size 5

	Distribution/Mixed		Automation
1SL0215A00	Box + transparent door	1SL0205A00	Box + opaque door
1SL0286A00	Uprights	1SL0279A00	Drilled base plate
1SL0337A00	Kit for Tmax	1SL0255A00	Inner door
1SL0303A00	Modular plate 2 mod.	See page 2/9	Wiring duct
1SL0332A00	Blank panel 2 mod.	See page 2/9	Fix-O-Rapid
1SL0314A00	Drilled panel 1+1/2 mod.	1SL0342A00	Wall-mounting brackets
1SL0320A00	Blank panel 1/2 mod.	1SL0350A00	Ventilation kit
12863	Module covers		

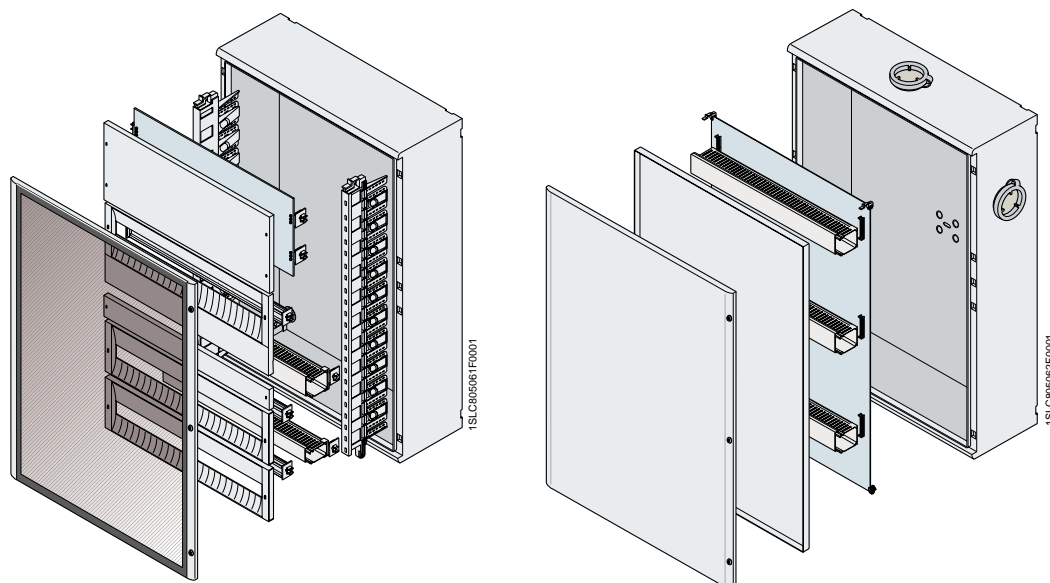

Size 6

	Distribution/Mixed		Automation
1SL0216A00	Box + transparent door	1SL0206A00	Box + opaque door
1SL0288A00	Uprights	1SL0264A00	Metal base plate
1SL0304A00	Modular plate 2 mod.	1SL0256A00	Inner door
1SL0333A00	Blank panel 2 mod.	See page 2/9	Wiring duct
1SL0315A00	Drilled panel 1+1/2 mod.	See page 2/9	Fix-O-Rapid
1SL0321A00	Blank panel 1/2 mod.	1SL0341A00 (x3)	Triangular lock
1SL0310A00 (x2)	Panel with holes 1 mod.	1SL0351A00 (x3)	Anti-condensation kit
1SL0356A00	Wiring kit 25x60 mm		
1SL0363A00	Wiring kit 40x60 mm		

Technical information

Component mounting distances

Component mounting distances

The reference mounting distances between components for the functional configuration of Gemini switchboards are shown in the diagrams.

Automation components

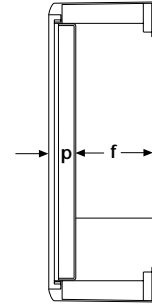
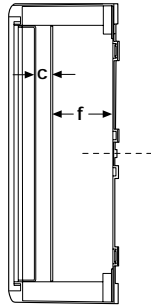

size	f = distance mounting plate/floor		c = distance mounting plate/inner door	
	MIN.	MAX.	MIN.	MAX.
1	16.3	91	-	-
2	36.4	140	33.5	139
3	36.4	140	33.5	139
4	36.4	140	33.5	139
5	47	244	33.5	228
6	47	244	33.5	228

size	p = distance inner door/door	f = distance inner door/floor
	1	-
2	63	177
3	63	177
4	63	177
5	63	277
6	63	277

Distribution components

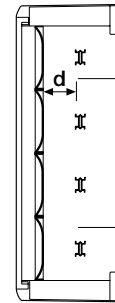
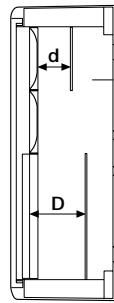

d = distance drilled panel/plate

pos. 1	pos. 2	pos. 3	pos. 4	pos. 5	pos. 6
54.7	67.2	79.7	92.2	-	-
54.7	67.2	79.7	92.2	104.7	117.2
54.7	67.2	79.7	92.2	104.7	117.2
54.7	67.2	79.7	92.2	104.7	117.2
54.7	67.2	79.7	92.2	104.7	117.2
54.7	67.2	79.7	92.2	104.7	117.2

d = distance drilled panel/DIN rail

size	pos. 1	pos. 2	pos. 3	pos. 4	pos. 5	pos. 6
1	51	63.5	76	88.5	-	-
2	51	63.5	76	88.5	101	113.5
3	51	63.5	76	88.5	101	113.5
4	51	63.5	76	88.5	101	113.5
5	51	63.5	76	88.5	101	113.5
6	51	63.5	76	88.5	101	113.5

D = distance blank panel/plate

pos. 1	pos. 2	pos. 3	pos. 4	pos. 5	pos. 6
71.5	84	96.5	109	-	-
71.5	84	96.5	109	121.5	134
71.5	84	96.5	109	121.5	134
71.5	84	96.5	109	121.5	134
71.5	84	96.5	109	121.5	134
71.5	84	96.5	109	121.5	134

Measurements are expressed in millimeters

Technical information

Component mounting distances

3

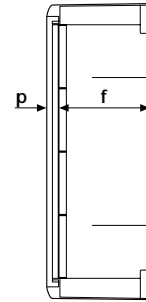
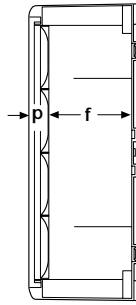

size	p = distance drilled panel/door	f = distance drilled panel/floor
1	44	145
2	44	197
3	44	197
4	44	197
5	44	297
6	44	297

size	p = distance blank panel/door	f = distance blank panel/floor
1	26.5	162
2	26.5	214
3	26.5	214
4	26.5	214
5	26.5	314
6	26.5	314

1SLC260004R0201

Technical information

Disposal instructions

Information about how to dispose of Gemini switchboards when they reach the end of their life

Instructions are given below about the procedures to adopt when disposing of Gemini switchboards at the end of their life cycle. The text is drafted in the form of a table referring to Standard CEI 308-1 "Information table concerning the end of life of electric and electronic products and a compilation guide", 2002-04, ed. 1, pamphlet number 308-1 6454.

Section I - Global product specification

Name Size	Type of product		Rated weight (kg)	External dimensions WxHxD (mm)
	With transparent door	With opaque door		
1	1SL0211A00	1SL0201A00	4,3	335x400x210
2	1SL0212A00	1SL0202A00	7,9	460x550x260
3	1SL0213A00	1SL0203A00	9,5	460x700x260
4	1SL0214A00	1SL0204A00	12,0	590x700x260
5	1SL0215A00	1SL0205A00	17,8	590x855x360
6	1SL0216A00	1SL0206A00	21,1	840x1005x360

3

Section II - Global product table

General code: CER 17 02 03 plastic (more than 95% of the product's weight)

No. of the component part (P1, P2, etc.)	Diagram	Quantity % over total weight	Material description	Symbol	Dangerousness (Yes/No)	CER Code
P1/BOX		~ 80%	Polypropylene		No	17 02 03
P2/ROOF			Polypropylene		No	17 02 03
P3/DOOR		~ 20%	Polycarbonate		No	17 02 03
P4/ACCESSORIES		< 5%	Steel	-	No	17 04 05
P5/ACCESSORIES		< 5%	Brass	-	No	17 04 01

1SLC805018FF0201

Technical information

Disposal instructions

Section III - Components to be removed from the product and sent for separate treatment

Refer to section II of the table for a description of the materials.

Notes for recovery and disposal

At the end of its life, after separating it from components, the product can be sent to be recovered.

The product is not biodegradable: do not dispose of it in the environment.

The product/waste product is assimilable as solid urban waste. It must be incinerated or disposed of in compliance with current EEC, national and local regulations. You are recommended to check all reutilization possibilities.

Other recommendations

The information in this table relates to the product in the condition it was supplied. Assembled parts coming from different supplies must be treated separately according to the reference specifications of the respective manufacturers.

3

Section IV - Safety instructions

Handling

No special instructions. Refer to the general regulations concerning hygiene on the workplace when using.

The product's main components contain mineral additives and coloring agents in concentrations that comply with current European Directives at the time this catalogue went to press: they do not contain substances classified as dangerous.

Transport

No special instructions.

Storage

No gas or harmful vapors are released during storage. Thermal decomposition in the event of fire or combustion may release dangerous products: if this should occur, specific means of protection must be used. In the event of fire, conventional fire extinguishing instruments are recommended (atomized water, foam, carbon dioxide, powder).

Empty packages are not contaminated by the product and can therefore be recycled or reused.

Utilization

No special instructions.

Other instructions

The information given in this section is based on current ABB SACE know-how and is aimed at describing the product only for environmental, health and safety purposes. It must not, therefore, be considered as a guarantee of specific properties. ABB SACE assumes no responsibility for the behavior of buyers that do not comply with the information given in this table and for incorrect or improper usages of the product or usages that cannot reasonably be envisaged.



Overall dimensions

Index

Basic configuration	4/2
Components for automation applications	4/5
Components for distribution and mixed applications	4/6

Overall dimensions

Basic configuration

Front view

Size 1

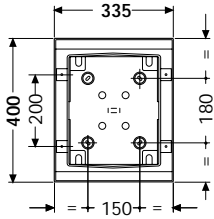

code
1SL0201A00 - 1SL0211A00 - 1SL0221A00

Size 2

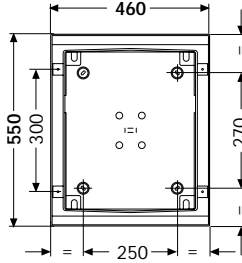

code
1SL0202A00 - 1SL0212A00 - 1SL0222A00

Size 3

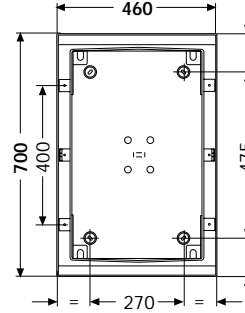

code
1SL0203A00 - 1SL0213A00 - 1SL0223A00

Size 4

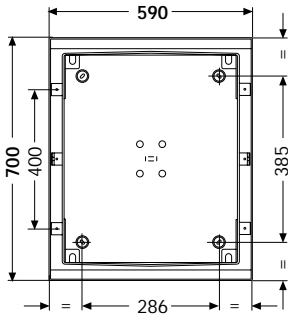

code
1SL0204A00 - 1SL0214A00 - 1SL0224A00

Size 5

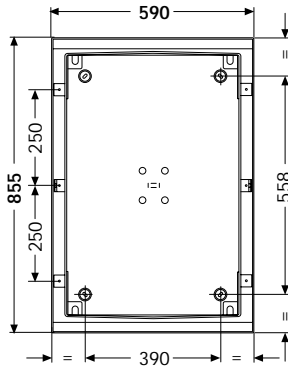

code
1SL0205A00 - 1SL0215A00 - 1SL0225A00

Size 6

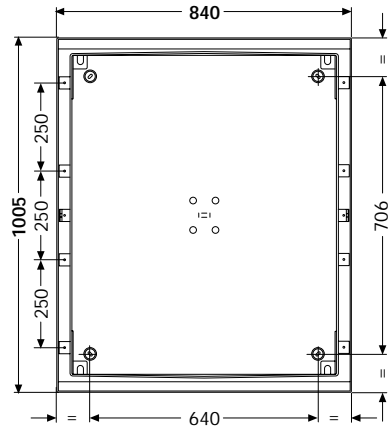

code
1SL0206A00 - 1SL0216A00 - 1SL0226A00

Top view

Size 1

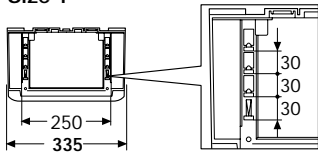

Size 2

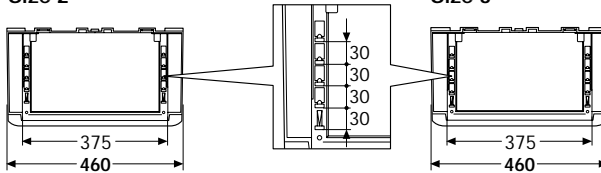

Size 3

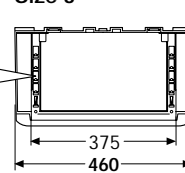

Size 4

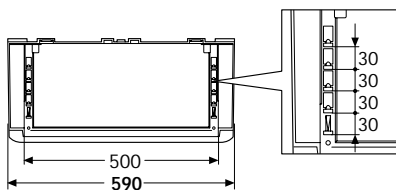

Size 5

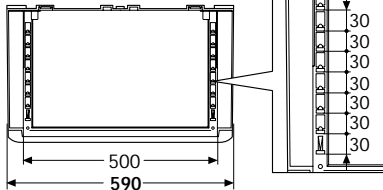

Size 6

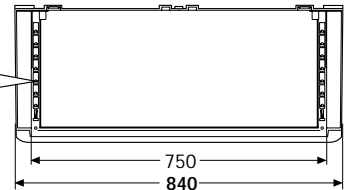

Measurements are expressed in millimeters

1SLC695007F0201

Overall dimensions

Basic configuration

Side view

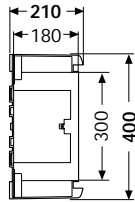

Size 1

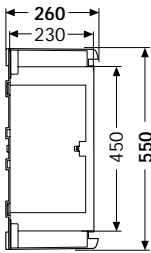

Size 2

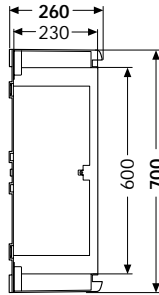

Size 3

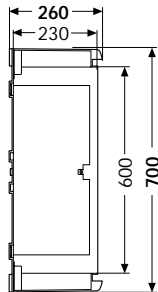

Size 4

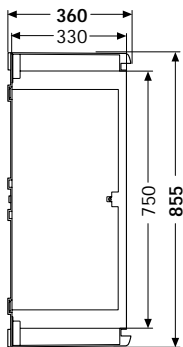

Size 5

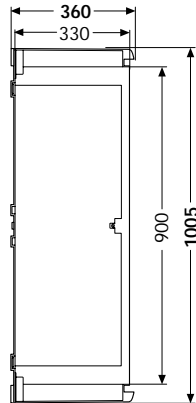

Size 6

Installation with brackets

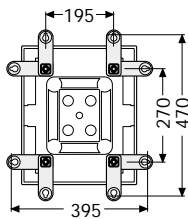

Size 1

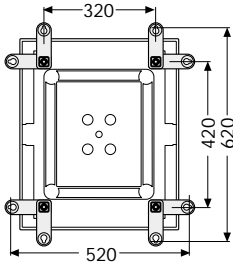

Size 2

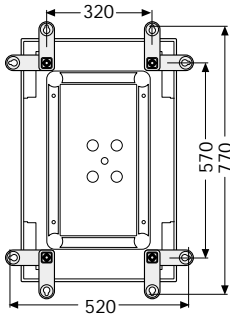

Size 3

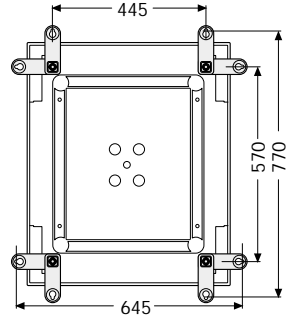

Size 4

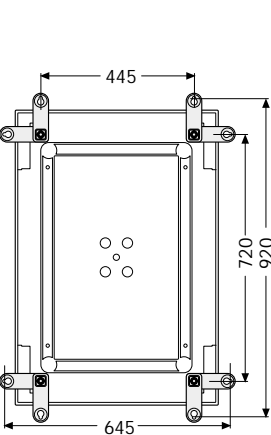

Size 5

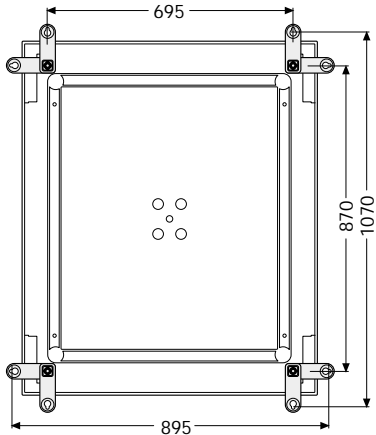

Size 6

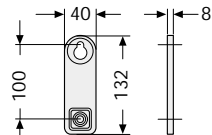

Bracket

Measurements are expressed in millimeters

Overall dimensions

Basic configuration

External opaque and transparent doors

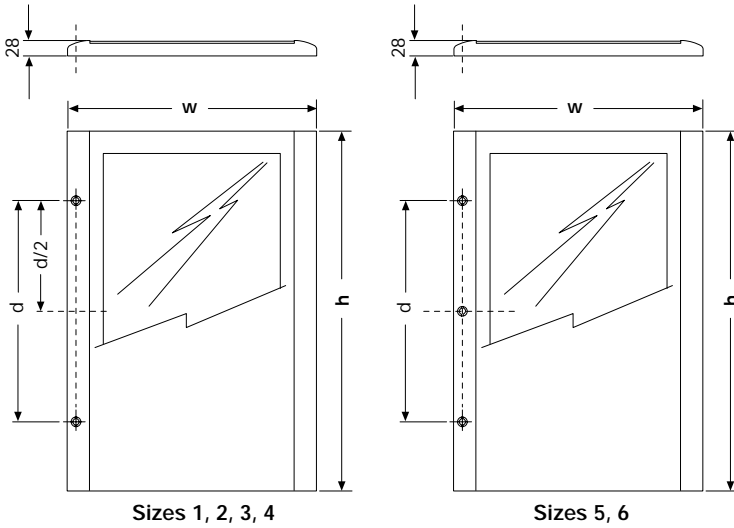

size	w	h	locks	d = distance locks
1	325	349	2	200
2	450	499	2	300
3	450	649	2	400
4	575	649	2	400
5	575	799	3	500
6	825	949	3	750

Sizes 1, 2, 3, 4

Sizes 5, 6

Overall dimensions

Components for automation applications

Base plates

Blank and insulating

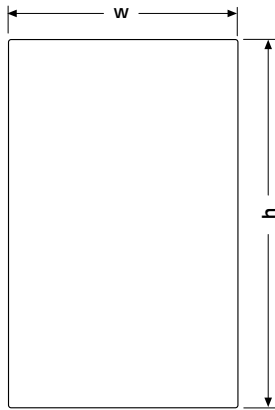

Drilled

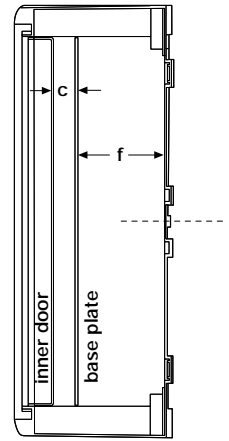
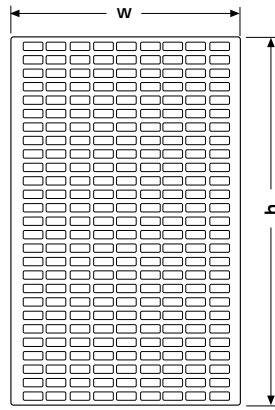

size	w	h	drilled		f = distance base		c = distance inner door	
			d	d	MIN.	MAX.	MIN.	MAX.
1	235	285	2	5	16.3	91	-	-
2	360	435	2	5	36.4	140	33.5	139
3	360	585	2	5	36.4	140	33.5	139
4	485	585	2	5	36.4	140	33.5	139
5	485	735	2	5	47	244	33.5	228
6	735	885	2	5	47	244	33.5	228

The distance of the plate from the base and inner door depends on the installation point selected for mounting the plate on the box.

Inner doors

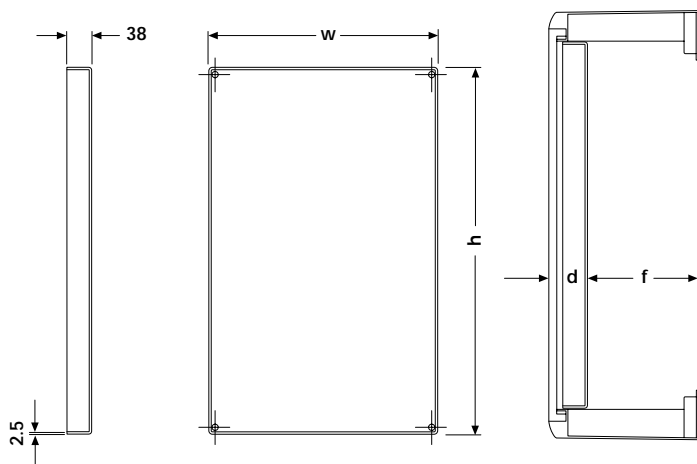

size	w	h	distance inner door	
			d = door	f = base
1	-	-	-	-
2	375	450	63	177
3	375	600	63	177
4	500	600	63	177
5	500	750	63	277
6	750	900	63	277

Measurements are expressed in millimeters

Overall dimensions

Components for distribution and mixed applications

Uprights

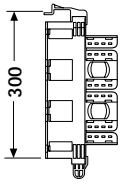

Size 1

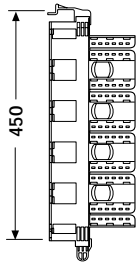

Size 2

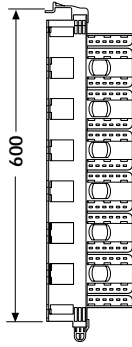

Sizes 3, 4

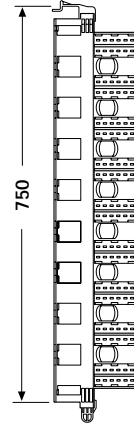
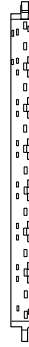

Size 5

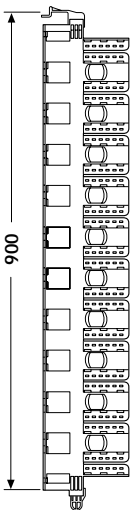
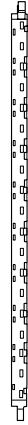

Size 6

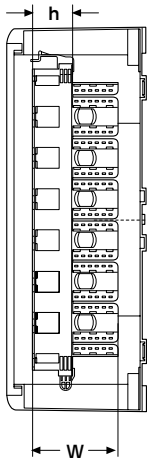
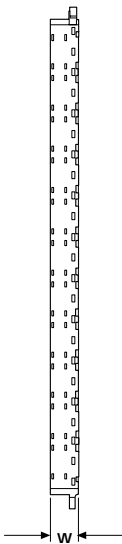

upright size	duct		
	W	w	h
1	132	18	46
2	152	27	46
3	152	27	46
4	152	27	46
5	152	36	46
6	152	55	46

Measurements are expressed in millimeters

1SLC695011F0201

Overall dimensions

Components for distribution and mixed applications

DIN rail

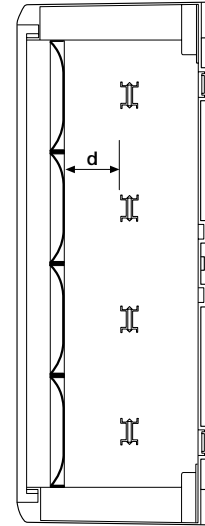
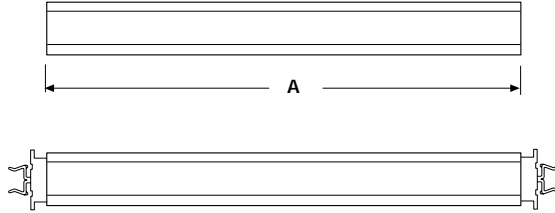
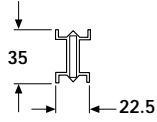

d = distance between panel with holes/DIN rail

size	A	pos. 1	pos. 2	pos. 3	pos. 4	pos. 5	pos. 6
1	210	51	63.5	76	88.5	-	-
2	318	51	63.5	76	88.5	101	113.5
3	318	51	63.5	76	88.5	101	113.5
4	443	51	63.5	76	88.5	101	113.5
5	443	51	63.5	76	88.5	101	113.5
6	663	51	63.5	76	88.5	101	113.5

The distances of the DIN rail from the panel depend on the depth at which the DIN rail is regulated by using fixing devices.

Drilled panels

1 + 1/2 module

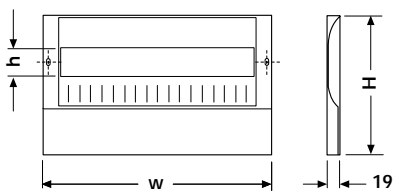

1 module

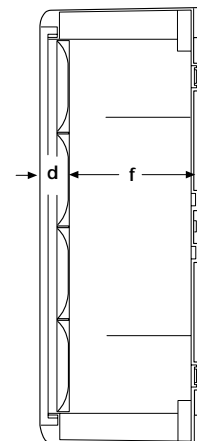

drilled panel	1 mod.		1+1/2 mod.		window		distance panel	
size	w	H	w	H	w	modules	d = door	f = base
1	250	150	-	-	46	12	44	145
2	375	150	375	225	46	18	44	197
3	375	150	375	225	46	18	44	197
4	500	150	500	225	46	24	44	197
5	500	150	500	225	46	24	44	297
6	750	150	750	225	46	36	44	297

Measurements are expressed in millimeters

Overall dimensions

Components for distribution and mixed applications

Blank panels

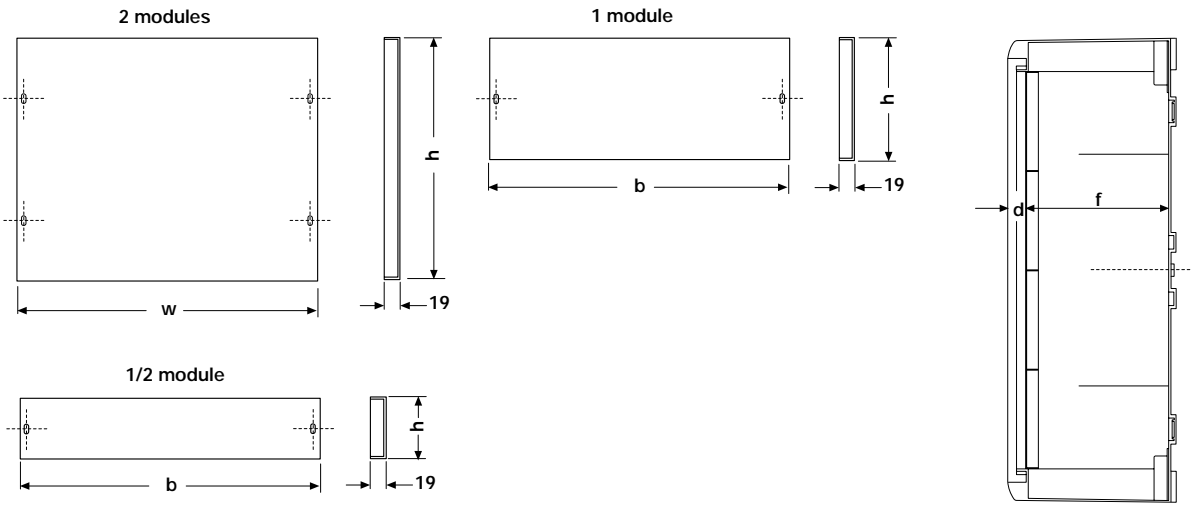

	1/2 mod.		1 mod.		2 mod.		distance panel	
size	w	h	w	h	w	h	d = door	f = base
1	250	75	250	150	250	300	26.5	162
2	375	75	375	150	375	300	26.5	214
3	375	75	375	150	375	300	26.5	214
4	500	75	500	150	500	300	26.5	214
5	500	75	500	150	500	300	26.5	314
6	750	75	750	150	750	300	26.5	314

Kit for Tmax

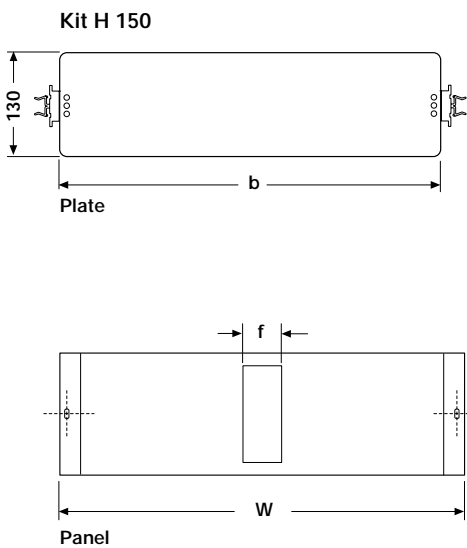

kit for Tmax H 150 (available for sizes 2-6)

size	W	H	d	f	b
2	375	150	19	46	318
3	375	150	19	46	318
4	500	150	19	46	443
5	500	150	19	46	443
6	750	150	19	46	663

Kit H 300

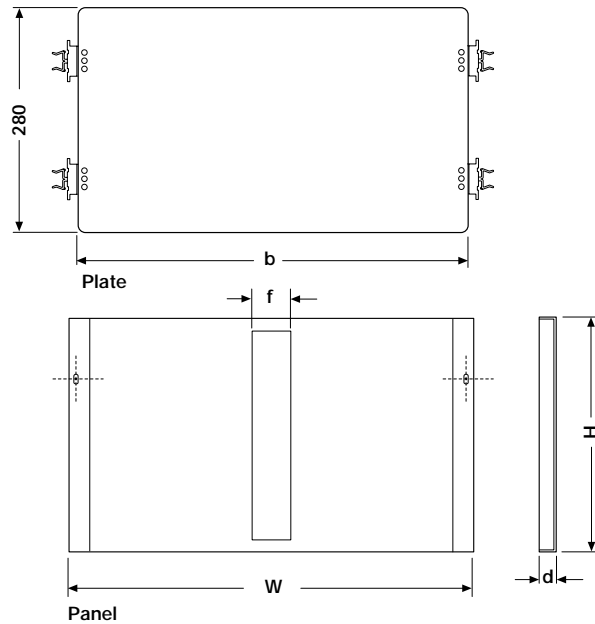

kit for Tmax H 300 (available for sizes 2-6)

size	W	H	d	f	b
2	375	300	19	46	318
3	375	300	19	46	318
4	500	300	19	46	443
5	500	300	19	46	443
6	750	300	19	46	663

Measurements are expressed in millimeters

1SLC65013F0201

Overall dimensions

Components for distribution and mixed applications

Modular plates

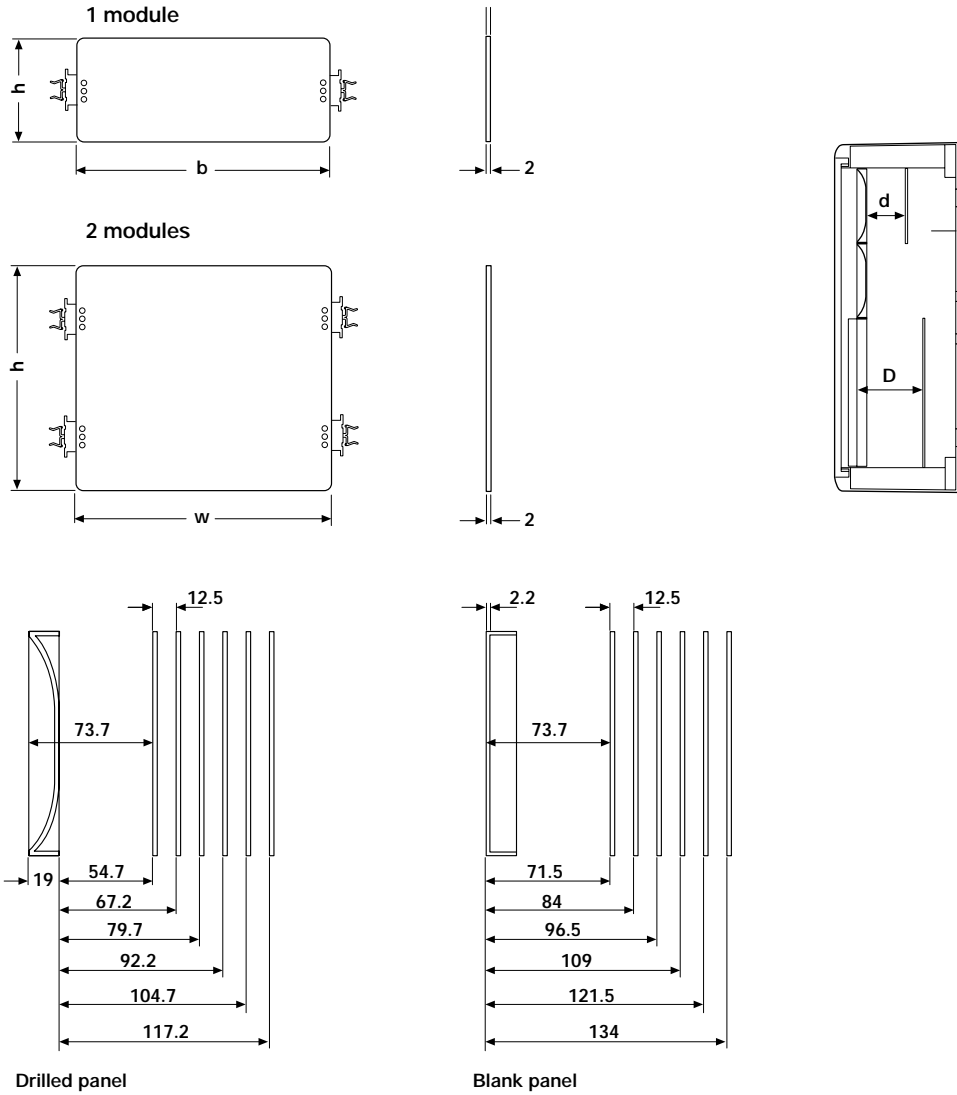

size	1 module		2 modules		D = distance blank panel/plate						d = distance drilled panel/plate					
	w	h	w	h	pos. 1	pos. 2	pos. 3	pos. 4	pos. 5	pos. 6	pos. 1	pos. 2	pos. 3	pos. 4	pos. 5	pos. 6
1	210	130	-	-	71.5	84	96.5	109	-	-	54.7	67.2	79.7	92.2	-	-
2	318	130	318	280	71.5	84	96.5	109	121.5	134	54.7	67.2	79.7	92.2	104.7	117.2
3	318	130	318	280	71.5	84	96.5	109	121.5	134	54.7	67.2	79.7	92.2	104.7	117.2
4	443	130	443	280	71.5	84	96.5	109	121.5	134	54.7	67.2	79.7	92.2	104.7	117.2
5	443	130	443	280	71.5	84	96.5	109	121.5	134	54.7	67.2	79.7	92.2	104.7	117.2
6	663	130	663	280	71.5	84	96.5	109	121.5	134	54.7	67.2	79.7	92.2	104.7	117.2

The distance of the panels from the modular plates depends on the depth at which the DIN rail is regulated by using fixing devices.

Measurements are expressed in millimeters

Overall dimensions

Components for distribution and mixed applications

Wiring kit

Duct 25x60 mm

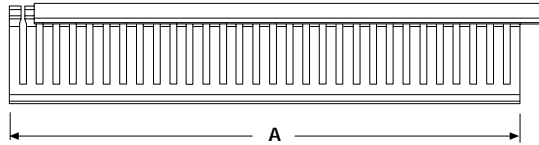
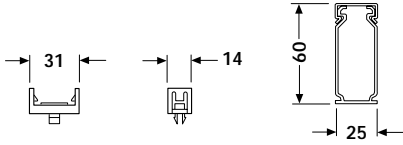

Duct 40x60 mm

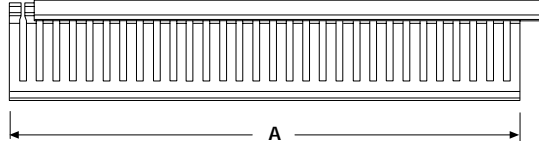
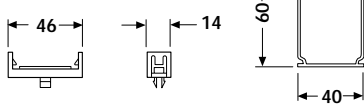

size	A
1	210
2	318
3	318
4	443
5	443
6	663

Ventilation kit

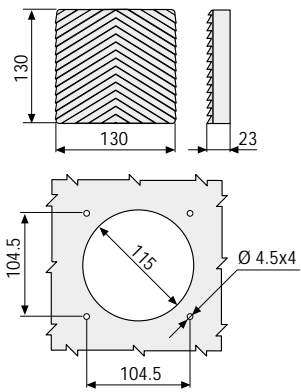

Anti-condensation kit

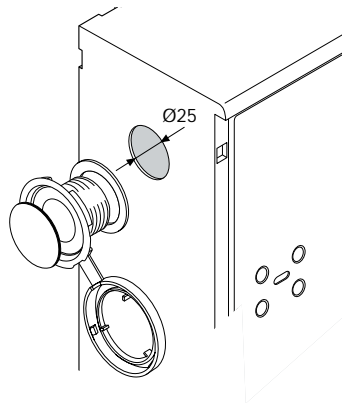

Pedestal

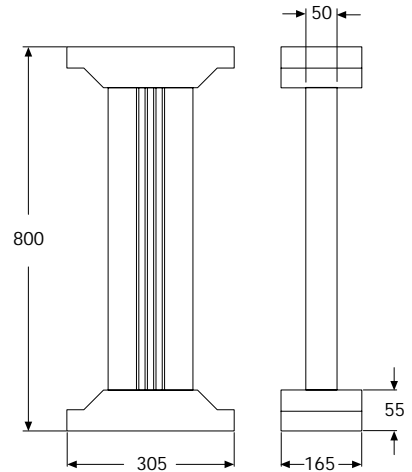

Pole installation kit

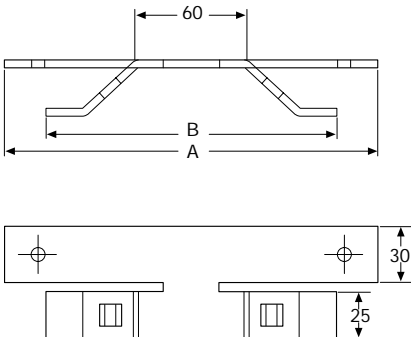

size	A	B
1	232	206
2-3	358	332
4-5	483	457
6	733	707

Measurements are expressed in millimeters

1SLCB6015F0201

Code list

Code	Chapter/Page	Code	Chapter/Page
05 019	2/9	05 199	2/9
05 033	2/9	05 270	2/9
05 035	2/9	05 272	2/9
05 037	2/9	05 274	2/9
05 043	2/9	05 276	2/9
05 045	2/9	05 278	2/9
05 047	2/9	05 280	2/9
05 049	2/9	05 282	2/9
05 051	2/9	1SL0201A00	2/4
05 053	2/9	1SL0202A00	2/4
05 063	2/9	1SL0203A00	2/4
05 065	2/9	1SL0204A00	2/4
05 067	2/9	1SL0205A00	2/4
05 069	2/9	1SL0206A00	2/4
05 071	2/9	1SL0211A00	2/4
05 073	2/9	1SL0212A00	2/4
05 083	2/9	1SL0213A00	2/4
05 085	2/9	1SL0214A00	2/4
05 087	2/9	1SL0215A00	2/4
05 089	2/9	1SL0216A00	2/4
05 091	2/9	1SL0221A00	2/5
05 093	2/9	1SL0222A00	2/5
05 094	2/9	1SL0223A00	2/5
05 095	2/9	1SL0224A00	2/5
05 096	2/9	1SL0225A00	2/5
05 097	2/9	1SL0226A00	2/5
05 099	2/9	1SL0231A00	2/5
05 119	2/9	1SL0232A00	2/5
05 133	2/9	1SL0233A00	2/5
05 135	2/9	1SL0234A00	2/5
05 137	2/9	1SL0235A00	2/5
05 143	2/9	1SL0236A00	2/5
05 145	2/9	1SL0241A00	2/5
05 147	2/9	1SL0242A00	2/5
05 149	2/9	1SL0243A00	2/5
05 151	2/9	1SL0244A00	2/5
05 153	2/9	1SL0245A00	2/5
05 163	2/9	1SL0246A00	2/5
05 165	2/9	1SL0252A00	2/8
05 167	2/9	1SL0253A00	2/8
05 169	2/9	1SL0254A00	2/8
05 171	2/9	1SL0255A00	2/8
05 173	2/9	1SL0256A00	2/8
05 183	2/9	1SL0259A00	2/8
05 185	2/9	1SL0260A00	2/8
05 187	2/9	1SL0261A00	2/8
05 189	2/9	1SL0262A00	2/8
05 191	2/9	1SL0263A00	2/8
05 193	2/9	1SL0264A00	2/8
05 194	2/9	1SL0267A00	2/8
05 195	2/9	1SL0268A00	2/8
05 196	2/9	1SL0269A00	2/8
05 197	2/9	1SL0270A00	2/8
		1SL0271A00	2/8

Code list

Code	Chapter/Page	Code	Chapter/Page
1SL0272A00	2/8	1SL0351A00	2/19
1SL0275A00	2/8	1SL0352A00	2/18
1SL0276A00	2/8	1SL0353A00	2/15
1SL0277A00	2/8	1SL0354A00	2/15
1SL0278A00	2/8	1SL0355A00	2/15
1SL0279A00	2/8	1SL0356A00	2/15
1SL0280A00	2/8	1SL0360A00	2/15
1SL0283A00	2/12	1SL0361A00	2/15
1SL0284A00	2/12	1SL0362A00	2/15
1SL0285A00	2/12	1SL0363A00	2/15
1SL0286A00	2/12	1SL0370A00	2/14
1SL0287A00	2/12	1SL0371A00	2/14
1SL0290A00	2/12	1SL0372A00	2/14
1SL0291A00	2/12	12851	2/19
1SL0292A00	2/12	12863	2/19
1SL0293A00	2/12	12894	2/19
1SL0296A00	2/14		
1SL0297A00	2/14		
1SL0298A00	2/14		
1SL0299A00	2/14		
1SL0302A00	2/14		
1SL0303A00	2/14		
1SL0304A00	2/14		
1SL0307A00	2/13		
1SL0308A00	2/13		
1SL0309A00	2/13		
1SL0310A00	2/13		
1SL0313A00	2/13		
1SL0314A00	2/13		
1SL0315A00	2/13		
1SL0318A00	2/13		
1SL0319A00	2/13		
1SL0320A00	2/13		
1SL0321A00	2/13		
1SL0324A00	2/13		
1SL0325A00	2/13		
1SL0326A00	2/13		
1SL0327A00	2/13		
1SL0330A00	2/13		
1SL0331A00	2/13		
1SL0332A00	2/13		
1SL0333A00	2/13		
1SL0336A00	2/14		
1SL0337A00	2/14		
1SL0338A00	2/14		
1SL0339A00	2/18		
1SL0340A00	2/18		
1SL0341A00	2/18		
1SL0342A00	2/18		
1SL0343A00	2/18		
1SL0344A00	2/18		
1SL0345A00	2/18		
1SL0346A00	2/18		
1SL0350A00	2/18		



UNI EN ISO 9001

Due to possible developments of standards as well as of materials, the characteristics and dimensions specified in the this document may only be considered binding after confirmation by ABB SACE.

ABB SACE S.p.A.
Enclosures and Cable Systems
Viale Vicenza, 61
36063 Marostica (VI) - Italy
Tel.: ++39 0424 478200 - Telefax: ++39 0424 478310

<http://www.abb.com>



1SLC805001D0201 November '03
Printed in Italy
10.000 - Oce Facility Services - Cal