

A Wide Range of Models with 5- to 40-A Output Currents and Up to 480-VAC/200-VDC Output Voltages

- All models feature the same compact dimensions to provide a uniform mounting pitch.
- Built-in varistor effectively absorb external surges.
- Operation indicator (red LED) enables monitoring operation.
- Protective cover for greater safety.
- Standard models approved by UL/CSA and -UTU models by VDE (TUV).



Ordering Information

Isolation	Zero cross function	Indicator	Rated output load (Applicable output load)	Rated input voltage	Model		
Phototriac	Yes	Yes	5 A at 24 to 240 VAC* (19 to 264 VAC)	5 to 24 VDC	G3NA-205B		
Photocoupler				100 to 120 VAC			
				200 to 240 VAC			
Phototriac	---	Yes	10 A at 24 to 240 VAC* (19 to 264 VAC)	5 to 24 VDC	G3NA-210B		
Photocoupler				100 to 120 VAC			
			200 to 240 VAC				
			10 A at 200 to 480 VAC* (180 to 528 VAC)	5 to 24 VDC	G3NA-410B		
				100 to 240 VAC			
			10 A at 5 to 200 VDC* (4 to 220 VDC)	5 to 24 VDC	G3NA-D210B		
		100 to 240 VAC					
Phototriac	Yes	Yes	20 A at 24 to 240 VAC* (19 to 264 VAC)	5 to 24 VDC	G3NA-220B		
Photocoupler				100 to 120 VAC			
				200 to 240 VAC			
				20 A at 200 to 480 VAC* (180 to 528 VAC)	5 to 24 VDC	G3NA-420B	
					100 to 240 VAC		
Phototriac			Yes	Yes	40 A at 24 to 240 VAC* (19 to 264 VAC)	5 to 24 VDC	G3NA-240B
Photocoupler						100 to 120 VAC	
						200 to 240 VAC	
					40 A at 200 to 480 VAC* (180 to 528 VAC)	5 to 24 VDC	G3NA-440B
			100 to 240 VAC				
		50 A at 200 to 480 VAC* (180 to 528 VAC)	5 to 24 VDC	G3NA-450B			

*Loss time increases under 75 VAC. (Refer to page 148.)

Note: When ordering a TÜV-approved model, add "-UTU" to the model number as shown below:
Example: G3NA-210B-UTU

■ Accessories (Order Separately)

Heat Sink

The following heat sinks are thin and can be DIN-track mounted (except Y92B-P250).

See *Dimensions* for details.

Model	Applicable SSR
Y92B-N50	G3NA-205B, G3NA-210B, G3NA-D210B, G3NA-410B, G3NE-205T(L), G3NE-210T(L)
Y92B-N100	G3NA-220B, G3NA-420B, G3NE-220T(L)
Y92B-N150	G3NA-240B, G3NA-440B
Y92B-P250	G3NA-450B

Low-cost Models

Model	Applicable SSR
Y92B-A100	G3NA-205B, G3NA-210B, G3NA-D210B, G3NA-220B, G3NA-410B, G3NA-420B
Y92B-A150N	G3NA-240B, G3NA-440B
Y92B-A250	G3NA-440B

Mounting Bracket

Used to mount the G3NA with a mounting dimension of 56 mm.

Model	Applicable SSR
R99-11	G3NA-240B, G3NA-440B

See *Dimensions* for details. (Refer to page 148.)

Specifications

■ Ratings

Input (Ambient Temperature: 25°C)

Model	Rated voltage	Operating voltage	Impedance	Voltage level	
				Must operate voltage	Must release voltage
G3NA-2□□B	5 to 24 VDC	4 to 32 VDC	7 mA max.*	4 VDC max.	1 VDC min.
	100 to 120 VAC	75 to 132 VAC	36 kΩ±20%	75 VAC max.**	20 VAC min.**
	200 to 240 VAC	150 to 264 VAC	72 kΩ±20%	150 VAC max.**	40 VAC min.**
G3NA-4□□B	5 to 24 VDC	4 to 32 VDC	5 mA max.*	4 VDC max.	1 VDC min.
	G3NA-D210B	100 to 240 VAC	75 to 264 VAC	72 kΩ±20%	75 VAC max.

Note: The input impedance is measured at the maximum value of the rated supply voltage (for example, with the model rated at 100 to 120 VAC, the input impedance is measured at 120 VAC).

*With constant current input circuit system. The impedance for the G3NA-□□□B-UTU is 15 mA max.

**Refer to the *Engineering Data* for further details.

Output

Model	Applicable load				
	Rated load voltage	Load voltage range	Load current		Inrush current
			With heat sink*	Without heat sink	
G3NA-205B	24 to 240 VAC	19 to 264 VAC	0.1 to 5 A	0.1 to 3 A	60 A (60 Hz, 1 cycle)
G3NA-210B			0.1 to 10 A	0.1 to 4 A	150 A (60 Hz, 1 cycle)
G3NA-410B	200 to 480 VAC	180 to 528 VAC	0.2 to 10 A	0.2 to 4 A	220 A (60 Hz, 1 cycle)
G3NA-220B	24 to 240 VAC	19 to 264 VAC	0.1 to 20 A	0.1 to 4 A	
G3NA-420B	200 to 480 VAC	180 to 528 VAC	0.2 to 20 A	0.2 to 4 A	
G3NA-240B	24 to 240 VAC	19 to 264 VAC	0.1 to 40 A	0.1 to 6 A	
G3NA-440B	200 to 480 VAC	180 to 528 VAC	0.2 to 40 A	0.2 to 6 A	440 A (60 Hz, 1 cycle)
G3NA-450B	200 to 480 VAC	180 to 528 VAC	0.2 to 50 A	0.2 to 6 A	
G3NA-D210B	5 to 200 VDC	4 to 220 VDC	0.1 to 10 A	0.1 to 4 A	20 A (10 ms)

*When OMRON's heat sink (refer to the accessories) or a heat sink of specified size is used.

■ Characteristics

Item	G3NA-205B, -210B, -220B	G3NA-240B	G3NA-410B, -420B, -440B, -450B	G3NA-D210B
Operate time	1/2 of load power source cycle + 1 ms max. (DC input) 3/2 of load power source cycle + 1 ms max. (AC input)			1 ms max. (DC input) 30 ms max. (AC input)
Release time	1/2 of load power source cycle + 1 ms max. (DC input) 3/2 of load power source cycle + 1 ms max. (AC input)			5 ms max. (DC input) 30 ms max. (AC input)
Output ON voltage drop	1.6 V (RMS) max.		1.8 V (RMS) max.	1.5 V max.
Leakage current	5 mA max. (at 100 VAC) 10 mA max. (at 200 VAC)		10 mA max. (at 200 VAC) 20 mA max. (at 400 VAC)	5 mA max. (at 200 VDC)
Insulation resistance	100 MΩ min. (at 500 VDC)			
Dielectric strength	2,500 VAC, 50/60 Hz for 1 min			
Vibration resistance	Malfunction: 10 to 55 Hz, 1.5-mm double amplitude			
Shock resistance	Malfunction: 1,000 m/s ²			
Ambient temperature	Operating: -30°C to 80°C (with no icing or condensation) Storage: -30°C to 100°C (with no icing or condensation)			
Approved standards	UL508 File No.E64562/CSA C22.2 (No.0, No.14) File No.LR35535 TÜV R9151660 (EN60950)			
Ambient humidity	Operating: 45% to 85%			
Weight	Approx. 60 g	Approx. 70 g	Approx. 80 g	Approx. 70 g

Engineering Data

Load Current vs. Ambient Temperature Characteristics

G3NA-205B

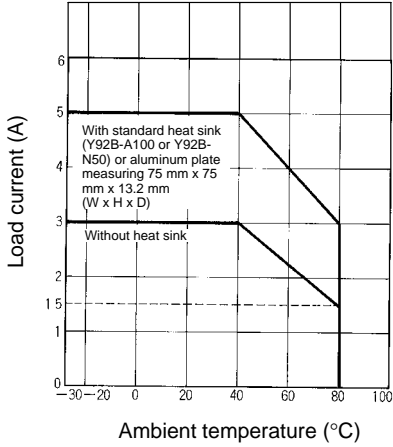

G3NA-210B/410B

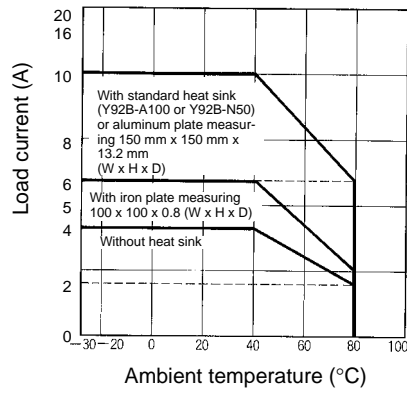

G3NA-220B/420B

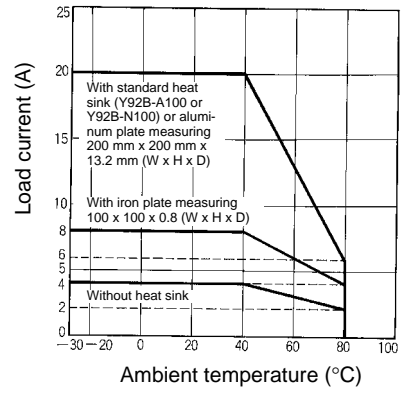

G3NA-240B

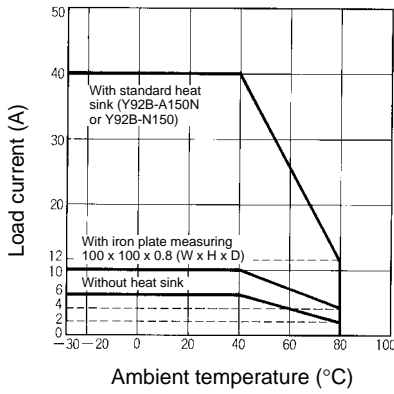

G3NA-440B

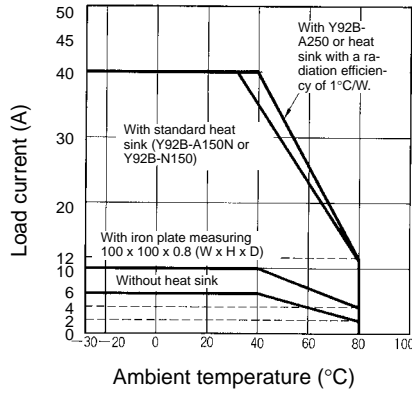

G3NA-D210B

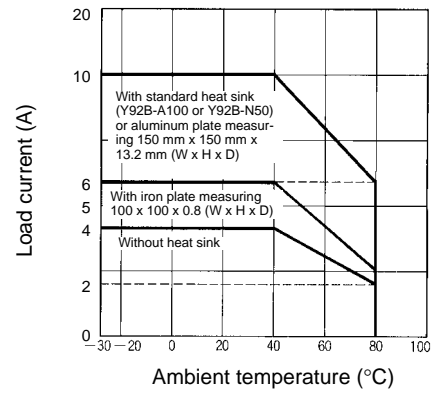

G3NA-450B

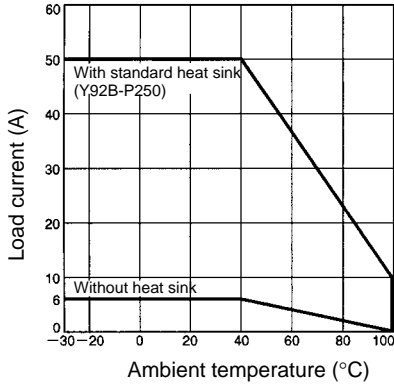

Inrush Current Resistivity

Non-repetitive (Keep the inrush current to half the rated value if it occurs repetitively.)

G3NA-205B

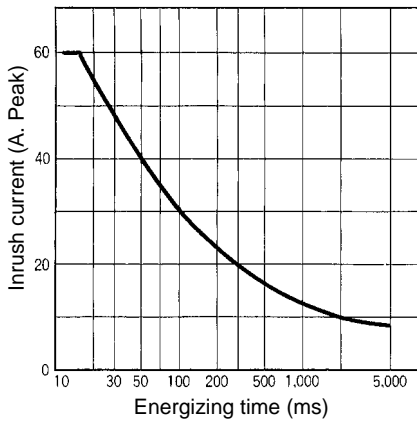

G3NA-210B/410B

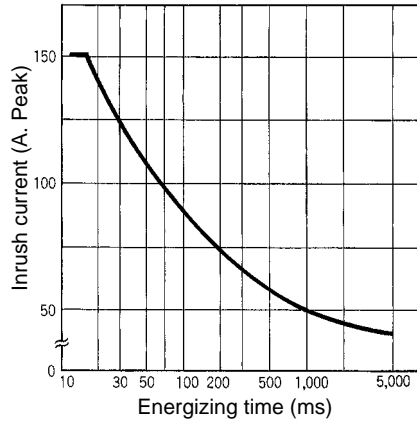

G3NA-220B/420B

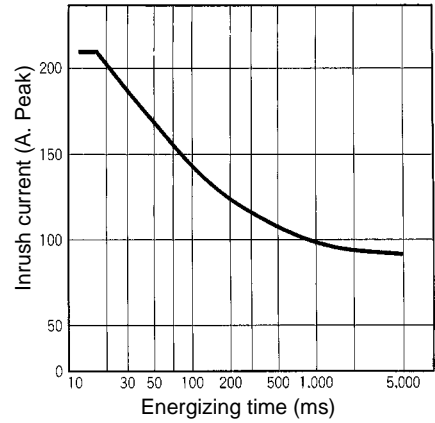

G3NA-240B/440B/450B

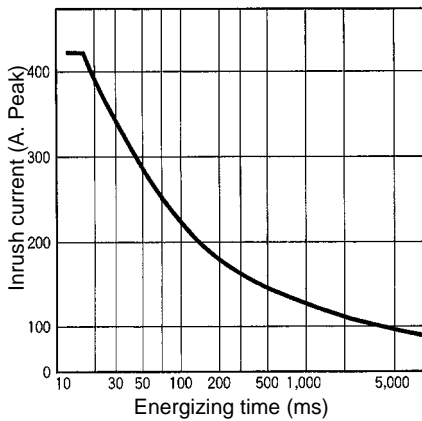

G3NA-D210B

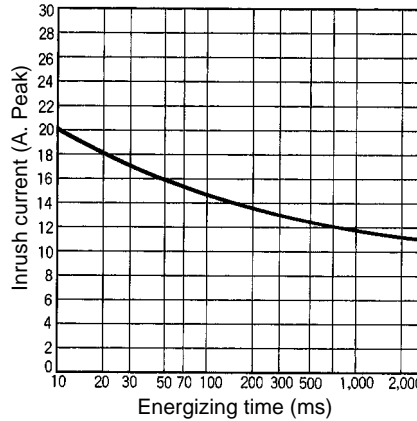

Temperature Characteristics (with Must Operate Voltage and Must Release Voltage)

G3NA-2□□B AC Input

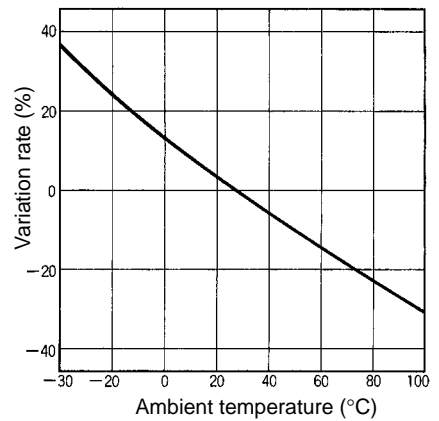

Heat Sink Size vs. Load Current

G3NA-220B

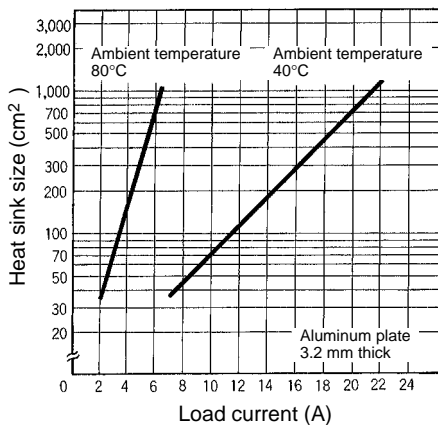

Note: The heat sink size refers to the combined area of the sides of the heat sink that radiate heat. For example, when a current of 18 A is allowed to flow through the SSR at 40°C, the graph shows that the heat sink size is about 450 cm². Therefore, if the heat sink is square, one side of the heat sink must be 15 cm (15² x 2 = 450) or longer.

Dimensions

Note: All units are in millimeters unless otherwise indicated.

In the case of surface mounting, a 30% derating of the load current is required.

The orientation indicated by the external dimensions is not the correct mounting orientation. When opening mounting holes, refer to the mounting hole dimensions.

G3NA-205B, G3NA-210B, G3NA-220B, G3NA-410B, G3NA-420B

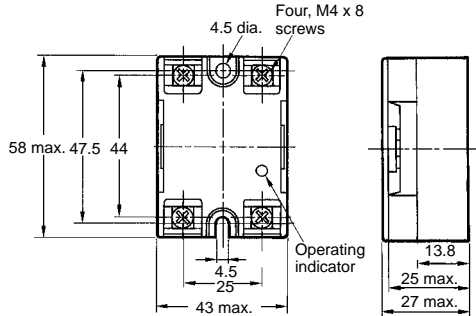
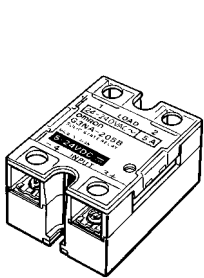

Mounting Holes

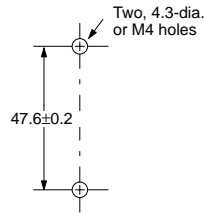

Terminal Arrangement/ Internal Connections (Top View)

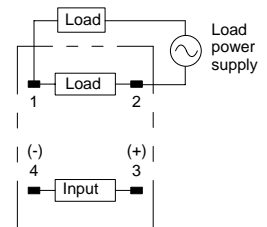

G3NA-240B, G3NA-440B, G3NA-450B

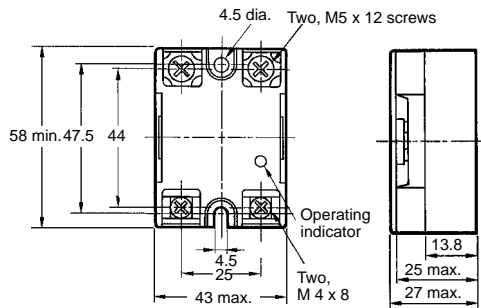
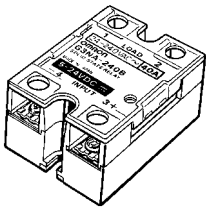

Mounting Holes

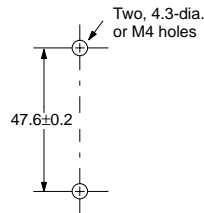

Terminal Arrangement/ Internal Connections (Top View)

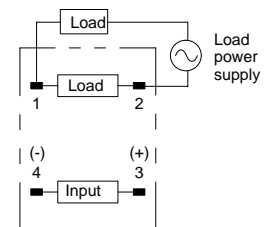

G3NA-D210B

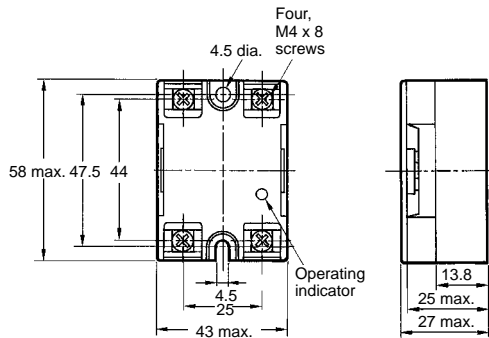
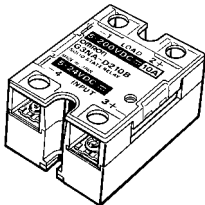

Mounting Holes

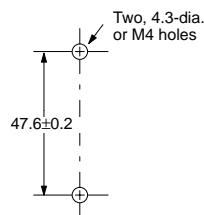

Terminal Arrangement/ Internal Connections (Top View)

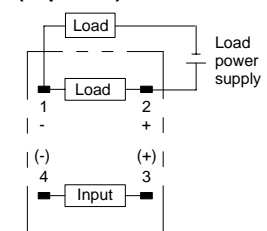

Heat Sink Y92B-N50

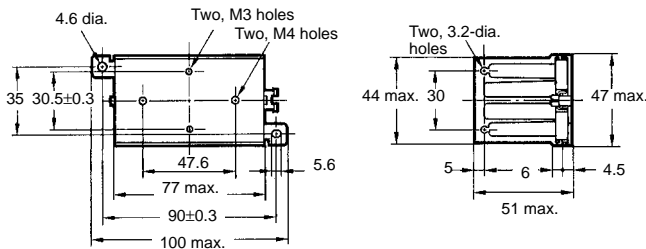
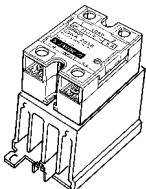

Mounting Holes

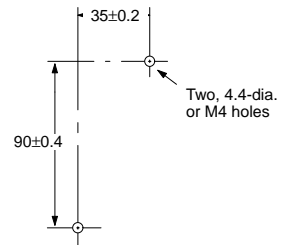

Weight: approx. 200 g

Y92B-N100

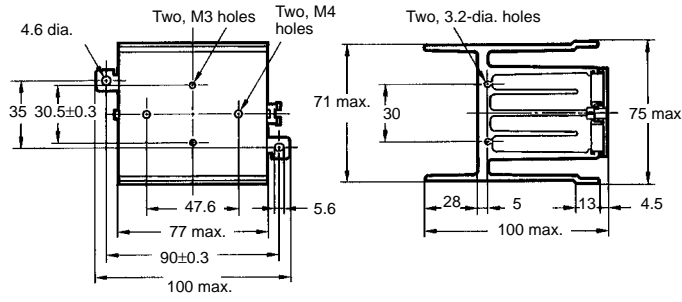
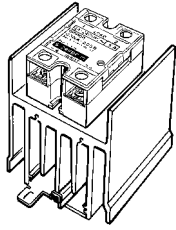

Mounting Holes

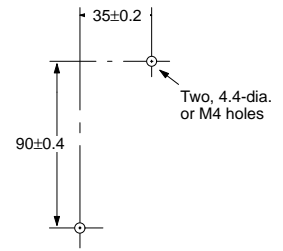

Weight: approx. 400 g

Y92B-N150

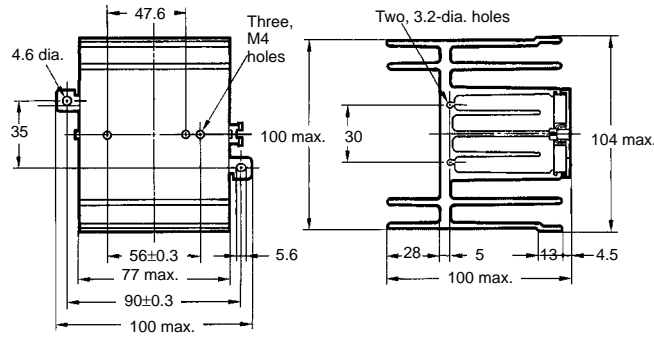
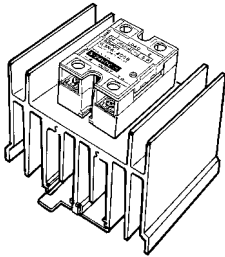

Mounting Holes

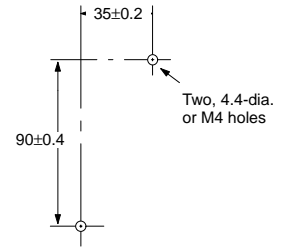

Weight: approx. 560 g

Y92B-A100

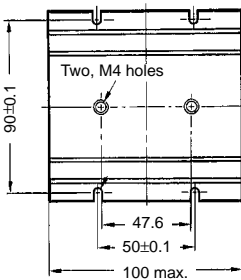

Y92B-A150N

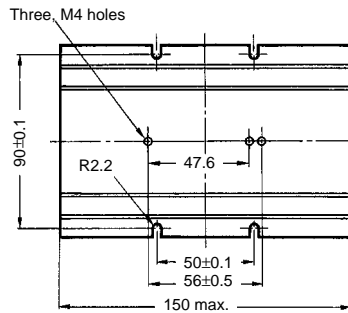

Y92B-A250

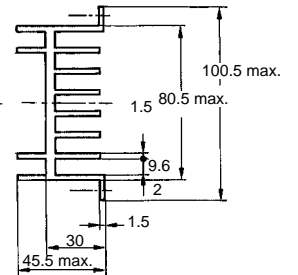
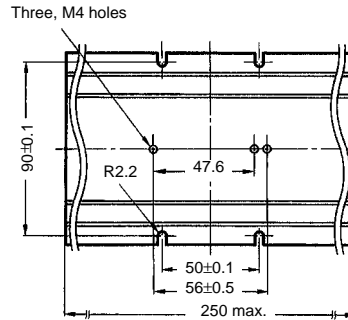

Mounting Holes
Y92B-A100
Y92B-A150
Y92B-A250

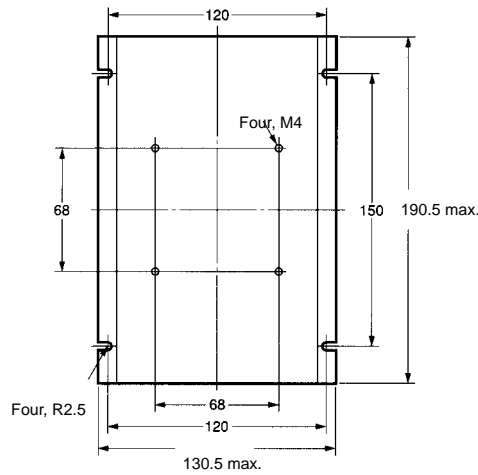
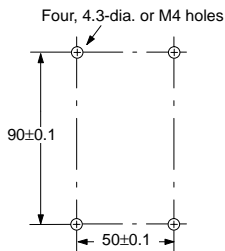

Mounting Holes

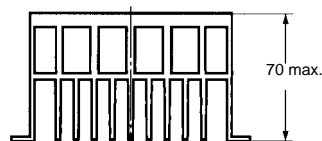
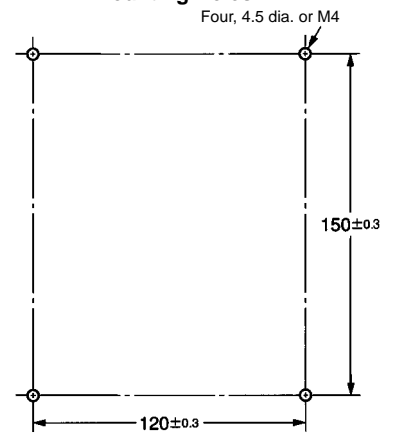

R99-11

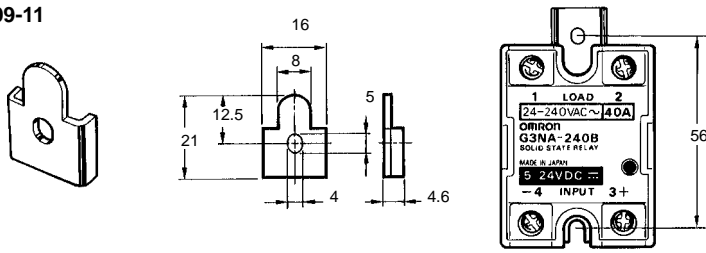

Use Mounting Bracket R99-11 so that the G3NA-240B can be mounted with the same pitch as that of the G3N-240B.

Precautions

Refer to pages 11 to 19 for general precautions.

Load Connection

For an AC load, use a power supply rated at 50 or 60 Hz. The maximum operating frequency is 10 Hz. The G3NA has a built-in varistor for overvoltage protection.

Zero Cross Function

An SSR with a zero cross function operates when an AC load voltage reaches the zero point or its vicinity. This reduces clicking noises when the load is input, and minimizes the influence of an inductive load, such as a lamp, heater, or motor, on the power supply because the inrush current of the load is reduced. This can also minimize the scale of the inrush current protection circuit.

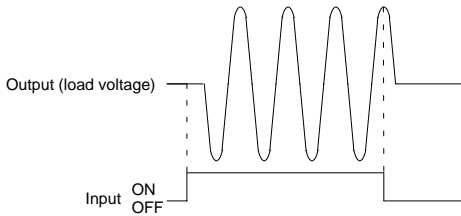

At a low applied voltage, such as 24 VAC, the load current is not fully supplied. When the Unit is switched ON, the voltage required to power the Unit deprives the output signal of the necessary voltage level and thus creates loss time. The lower the load voltage is, the greater the loss time is. This condition, however, will not create any serious problems.

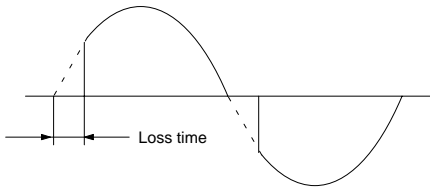

For a DC or L load, a diode should be connected in parallel the load to absorb the counter electromotive force of the load.

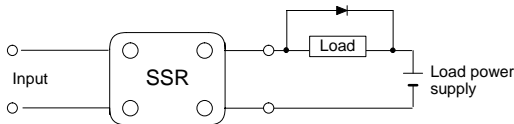

When attaching a heat sink to the G3NA, apply Silicone Grease or equivalent heat conductive grease on the heat sink. (Toshiba Silicon, Shinetsu Silicon, etc.)

Tighten the mounting screws of the heat sink with a torque of 0.78 to 0.98 N • m.

EN55011 Measurement of Mains Terminal Disturbance Voltage

The G3NA-UTU conforms to EN55011 standards when a capacitor is connected to the load power supply as shown in the following circuit diagram.

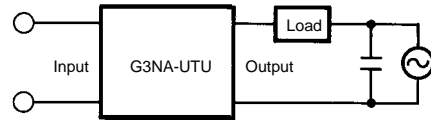

Recommended Capacitor:
Nissei Denki's MKT-series R40 (1 μF)

The output terminal side of the G3NA-D210B is connected to a built-in diode for protecting the SSR from damage that may result from reverse connection. The SSR, however, cannot withstand one minute or more if the wires are connected in reverse order. Therefore, pay the utmost attention not to make polarity mistakes on the load side.

ALL DIMENSIONS SHOWN ARE IN MILLIMETERS.

To convert millimeters into inches, multiply by 0.03937. To convert grams into ounces, multiply by 0.03527.