

Nexans



**Standard hook-up wires
and cables for Electronics
Filotex®**

Guideline of wires and cables 4

Part 1 - Standard coaxial cables 7

KX & RG standard coaxial cables 9

Data bus cable M17/176-00002 15

FLAMEX Halogen free coaxial cables 17

Telecom coaxial cables 19

Low noise coaxial cables 23

Miniature coaxial cables 25

Hand formable coaxial cables 27

Part 2 - Single core and multicore cables 29

Operating temperature:

80°C 31

105°C 53

150°C 77

200°C 87

250°C 99

Part 3 - Hook-up wires for wrapping 105

Part 4 - Accessories 109

In addition to the standard products, you will find within this catalogue, our development and design engineers are at your disposal to provide their experience in tailoring any of our products to meet your specific requirements.

Standard coaxial cables

Product range	Description	Page
COAX KX/RG	KX & RG standard coaxial cables	9
M17/176-00002	Data bus cable	15
COAX FLAMEX	FLAMEX halogen free coaxial cables	17
COAX TELECOMS	Telecom coaxial cables	19
CAS	Low noise coaxial cables	23
50/75 VMTX	Miniature coaxial cables	25
Quickform®	Hand formable coaxial cables	27

Single core and multicore cables

Maximum operating temperature	Insulation	Single-cores	Multi-cores	Product range	Description	Page
80°C	PE/PVC	●		HT	High voltage Hook-up wires	33
		●		UL 1007	UL qualified hook-up wires	35
	PVC	●	●	FM & FMA	Screened and jacketed hook-up wires and multicore cables for low frequency applications	37
		●	●	EHE & EHEA	Screened and jacketed hook-up wires and multicore cables for low frequency applications	39
			●	SMA & SMBL	Unscreened and jacketed (SMA), Screened and jacketed (SMBL) multicore cables	41
			●	GRTH & CCTB	Unscreened and jacketed (GRTH), Screened and jacketed (CCTB) multicore cables	43
			●	G250	Flexible pairs Screened with overall braid	45
			●	G900	Flexible pairs with individual and overall screens	47
	ZERO HAL		●	SMA-ZH SMBL-ZH	Unscreened and jacketed (SMA-ZH), Screened and jacketed (SMBL-ZH) halogen free multicore cables	49
			●	G250-ZH	Halogen free flexible pairs Screened with overall braid	51
105°C	PVC	●		UL 1015	UL qualified hook-up wires	55
		●		KY/EPDX	Unscreened hook-up wires	57
		●		KY/EPDX	Screened hook-up wires, screened and jacketed hook-up wires	59
			●	KY/EPDX	Screened pairs, screened and jacketed pairs	61
			●	KY/EPDX	Screened triples, screened and jacketed triples	63
	PVC-SUPER-POLYAMIDE	●		1604	Unscreened hook-up wires	65
		●	●	604	Screened and jacketed hook-up wires and multicore cables	67
		●		1625 A	Unscreened hook-up wires	69
	ZERO HAL	●		FLAMEX 20	Unscreened halogen free hook-up wires, Screened and jacketed hook-up wires	71
			●	FLAMEX 20	Screened and jacketed, halogen free multicore cables	73
●			KY/EPDX ZH	Halogen free unscreened hook-up wires	75	

Single core and multicore cables

Maximum operating temperature	Insulation	Single-cores	Multi-cores	Product range	Description	Page
150°C	FEP-SUPER-POLYAMIDE	●		1806	Unscreened hook-up wires	79
		●	●	806	Screened and jacketed hook-up wires and multicore cables	81
	ETFE	●	●	KU	Unscreened hook-up wires, pairs and triples	83
		●	●	KU	Screened and jacketed hook-up wires, pairs and triples	85
200°C	PTFE	●		KZ	Unscreened hook-up wires, High temperature	89
		●		KZ	Screened and jacketed hook-up wires, high temperature	91
			●	KZ	Screened and jacketed pairs, High temperature	93
			●	KZ	Screened and jacketed triples, High temperature	95
		●		ETF, EF & EEF	Unscreened hook-up wires, High temperature	97
250°C	PTFE	●		1900 A	Flexible cables for high ambient temperatures, Light weight cables	101
	PTFE-POLYIMIDE	●		2100	Flexible cables for high ambient temperatures	103

Hook-up wires for wrapping

Maximum operating temperature	Insulation	Single-cores	Multi-cores	Product range	Description	Page
From 85°C to 200°C	PVC ETFE PTFE	●		WCP WCZ WCT	Hook-up wires for wire-wrapping	107

Accessories

Accessories	Product range	Description	Page
BRAIDS	FITE	Tinned copper flat braids	111
	Tubular braids	Tubular braids in tinned copper without filler	113
	Tubular braids	Tubular braids in tinned copper with filler	115
	Tubular braids	Tubular superpolyamide braids, high temperature	117
TUBES	PTFE tubes	Extruded PTFE tubes	119

Symbols

Ambient Temperature

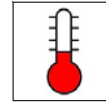

Flexibility



Chemical attacks

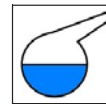

Fire performances



Smoke density

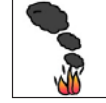

Gases corrosivity



Electro Magnetic Interference



Halogen free



ROHS compliant



Part 1
Standard coaxial
cables

KX & RG COAXIAL CABLES

KX/RG

Applications

Coaxial cables for high frequency connections.

Coaxial cables from 50 Ω to 95 Ω

Construction

1- CONDUCTOR

Stranded or solid, in bare copper (BC), tin plated copper (TPC), silver plated copper (SPC), copper clad steel (CCS) or silver plated copper clad steel (SPCCS)

2- DIELECTRIC

PE or PTFE

3- SCREEN

Single or double braid in bare, tin plated or silver plated copper

4- SHEATH

PVC, FEP, PFA or glass fibre

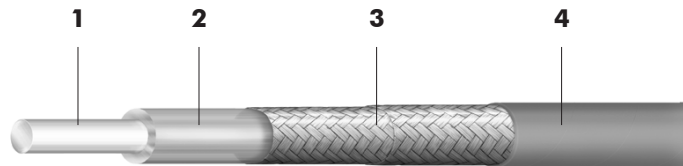

Bending radius

5 x overall diameter (for most coaxial cables)

Standards

MIL C17

NF C 93-550

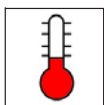

See on the following pages



See on the following pages



Flexible



EMI



RoHS

50 Ω KX & RG coaxial cables

Max. op. temp.	Dielectric	References according to		Nexans ref.	CONDUCTOR			Dielectric Ø mm	BRAIDS		SHEATH		Av. weight kg/km	Application
		NF. C 93-550	MIL C17		Composition n x Ø mm	Nature	Ø mm		Nb	Nature	Nature	Overall Ø mm		
85°C	PE	KX 3B		373095	7 x 0.16	CCS	0.48	1.50 ± 0.10	1	TPC	PVC	2.54 ± 0.13	10	①
			RG 174 AU	373171	7 x 0.16	CCS	0.48	1.52 ± 0.08	1	TPC	PVC	2.79 ± 0.13	12	①
		KX 15	RG 58 CU	373117	19 x 0.18	TPC	0.90	2.95 ± 0.10	1	TPC	PVC	4.95 ± 0.15	36	①
			RG 223 U	373184	1 x 0.89	SPC	0.89	2.95 ± 0.10	2	SPC	PVC	5.38 ± 0.10	55	①
		KX 4		373099	7 x 0.75	BC	2.25	7.25 ± 0.15	1	BC	PVC	10.30 ± 0.20	158	①
			RG 213 U	087023	7 x 0.75	BC	2.25	7.25 ± 0.15	1	BC	PVC	10.30 ± 0.20	158	①
			RG 214 U	373181	7 x 0.75	SPC	2.25	7.25 ± 0.18	2	SPC	PVC	10.80 ± 0.18	196	①
200°C and +	PTFE	KX 21 A		087126	7 x 0.10	SPCCS	0.30	0.87 ± 0.07	1	SPC	FEP	1.80 ± 0.10	9.6	②
			RG 178 BU (M17/169-00001)	087069	7 x 0.10	SPCCS	0.30	0.84 ± 0.05	1	SPC	FEP	1.80 ± 0.10	9.6	②
			RG 196 (M17/93-00001)	087247	7 x 0.10	SPCCS	0.30	0.84 ± 0.05	1	SPC	PFA	1.80 ± 0.10	9.6	②
		KX 22 A		087017	7 x 0.17	SPCCS	0.51	1.50 ± 0.10	1	SPC	FEP	2.50 ± 0.10	17	②
			RG 316 U (M17/172-00001)	085790	7 x 0.17	SPCCS	0.51	1.52 ± 0.08	1	SPC	FEP	2.49 ± 0.10	17	②
			RG 188 AU (M17/138-00001)	087245	7 x 0.17	SPCCS	0.51	1.52 ± 0.08	1	SPC	PFA	2.49 ± 0.10	17	②
			RG 142 AU	087009	1 x 0.94	SPCCS	0.94	2.95 ± 0.13	2	SPC	Glass fibre	5.10 ± 0.15	66	③
			RG 142 BU (M17/158-00001)	087066	1 x 0.94	SPCCS	0.94	2.95 ± 0.13	2	SPC	FEP	4.95 ± 0.13	68	③
			RG 400 U (M17/175-00001)	087125	19 x 0.20	SPC	0.98	2.95 ± 0.13	2	SPC	FEP	4.95 ± 0.13	66	③
		KX 23		087063	7 x 0.34	SPC	1.02	2.95 ± 0.15	2	SPC	Glass fibre	5.10 ± 0.20	70	③
			RG 393 (M17/174-00001)	085398	7 x 0.80	SPC	2.40	7.24 ± 0.13	2	SPC	FEP	9.91 ± 0.25	241	③
		KX 24		087029	7 x 0.80	SPC	2.40	7.25 ± 0.12	2	SPC	Glass fibre	10.90 ± 0.25	216	③

BC : bare copper
 TPC : tin plated copper
 SPC : silver plated copper
 CCS : copper clad steel
 SPCCS : silver plated copper clad steel

① High frequency connections.

② High frequency connections operating at high temperature. By their small dimensions, they are mainly designed for miniaturized connections, operating at high or low temperature.

50 Ω KX & RG coaxial cables

Operating temperature Min/Max	Fire properties	Max. op. frequency GHz	Nominal capacitance pF/m	Attenuation (db/100 m)				Dielectric strength kV	Powers at 40°C (kw)				Velocity of propagation	Continuous working voltage
				200 MHz	400 MHz	3000 MHz	10000 MHz		200 MHz	400 MHz	3000 MHz	10000 MHz		
-40 +85	NF C 32070/C2 IEC 60332 – 1&2	3	100.0	42	60	220		2	0.057	0.042	0.013		65.9	1100
-40 +85	NF C 32070/C2 IEC 60332 – 1&2	1	106.0	42	60	220		4.5	0.057	0.042	0.013		65.9	1100
-40 +85	NF C 32070/C2 IEC 60332 – 1&2	3	100.0	23	32	98		5	0.125	0.09	0.031		65.9	1400
-40 +85	NF C 32070/C2 IEC 60332 – 1&2	12.4	106.0	20	30	100	240	5	0.125	0.09	0.031	0.017	65.9	1400
-40 +85	NF C 32070/C2 IEC 60332 – 1&2	3	100.0	9.5	14.5	55		5	0.42	0.3	0.095	0.05	65.9	3700
-40 +85	NF C 32070/C2 IEC 60332 – 1&2	3	100.0	9.5	14.5	55		5	0.42	0.3	0.095	0.05	65.9	3700
-40 +85	NF C 32070/C2 IEC 60332 – 1&2	11	106.0	9	13	46	100	10	0.42	0.3	0.095	0.05	65.9	3700
-90 +200	NF C 32070/C1&C2 IEC 60332 – 1	3	95.0	65	95	300		1	0.085	0.057	0.018		69.5	750
-90 +200	NF C 32070/C1&C2 IEC 60332 – 1	3	105.0	58	80	225		2	0.085	0.057	0.018		69.5	750
-90 +230	NF C 32070/C1&C2 IEC 60332 – 1	3	105.0	58	80	225		2	0.085	0.057	0.018		69.5	750
-90 +200	NF C 32070/C1&C2 IEC 60332 – 1	3	95.0	40	55	160		2	0.17	0.11	0.032		69.5	900
-90 +200	NF C 32070/C1&C2 IEC 60332 – 1	3	105.0	40	55	160		2	0.17	0.11	0.032		69.5	900
-90 +230	NF C 32070/C1&C2 IEC 60332 – 1	3	105.0	40	55	160		2	0.17	0.11	0.032		69.5	900
-90 +250	NF C 32070/C1&C2 IEC 60332 – 1	3	95.0	19	27	79	163	5	0.66	0.45	0.15	0.08	69.5	1400
-90 +200	NF C 32070/C1&C2 IEC 60332 – 1	3	105.0	19	27	79	163	5	0.66	0.45	0.15	0.08	69.5	1400
-90 +200	NF C 32070/C1&C2 IEC 60332 – 1	3	105.0	20	29	89	185	5	0.66	0.45	0.15	0.08	69.5	1400
-90 +250	NF C 32070/C1&C2 IEC 60332 – 1	3	95.0	20	29	89	185	5	0.66	0.45	0.15	0.08	69.5	1400
-90 +200	NF C 32070/C1&C2 IEC 60332 – 1	11	105.0	9.3	14	47	109	4	2	1.3	0.43	0.22	69.5	3700
-90 +250	NF C 32070/C1&C2 IEC 60332 – 1	3	95.0	9.3	14	47	109	10	2	1.3	0.43	0.22	69.5	3700

③ High frequency connections operating at high temperature, or on equipment excepted to work under severe conditions without failure.

75 Ω KX & RG coaxial cables

Max. op. temp.	Dielectric	References according to		Nexans ref.	CONDUCTOR			Dielectric Ø mm	BRAIDS		SHEATH		Av. weight kg/km	Application
		NF. C 93-550	MIL C17		Composition n x Ø mm	Nature	Ø mm		Nb	Nature	Nature	Overall Ø mm		
85°C	PE		RG 59 BU	390650	1 x 0.58	CCS	0.58	3.71 ± 0.10	1	BC	PVC	6.15 ± 0.10	50	①
			KX 6A	373100	7 x 0.20	BC	0.60	3.70 ± 0.12	1	BC	PVC	6.10 ± 0.15	53	①
			RG 11 AU	373135	7 x 0.40	TPC	1.20	7.24 ± 0.18	1	BC	PVC	10.30 ± 0.18	136	①
			RG 216 U	373182	7 x 0.40	TPC	1.20	7.24 ± 0.18	2	BC	PVC	10.80 ± 0.18	177	①
			KX 8	373113	7 x 0.40	BC	1.20	7.25 ± 0.15	1	BC	PVC	10.30 ± 0.20	135	①
200°C and +	PTFE		RG 179 BU (M17/94-RG 179)	081997	7 x 0.10	SPCCS	0.30	1.60 ± 0.08	1	SPC	FEP	2.54 ± 0.13	16.9	②
			RG 187 AU (M17/136-00001)	087244	7 x 0.10	SPCCS	0.30	1.60 ± 0.08	1	SPC	PFA	2.54 ± 0.13	16.9	②

93-95 Ω KX & RG coaxial cables

Max. op. temp.	Dielectric	References according to		Nexans ref.	CONDUCTOR			Dielectric Ø mm	BRAIDS		SHEATH		Av. weight kg/km	Application
		NF. C 93-550	MIL C17		Composition n x Ø mm	Nature	Ø mm		Nb	Nature	Nature	Overall Ø mm		
93 Ω														
85°C	PE		RG 62 AU	373148	1 x 0.64	CCS	0.64	3.71 ± 0.13	1	BC	PVC	6.15 ± 0.18	46	①
95 Ω														
200°C and +	PTFE		RG 180 BU (M17/95-RG 180)	087241	7 x 0.10	SPCCS	0.30	2.59 ± 0.08	1	SPC	FEP	3.58 ± 0.10	27	②
			RG 195 AU (M17/137-00001)	087246	7 x 0.10	SPCCS	0.30	2.59 ± 0.08	1	SPC	PFA	3.58 ± 0.10	27	②

BC : bare copper
 TPC : tin plated copper
 SPC : silver plated copper
 CCS : copper clad steel
 SPCCS : silver plated copper clad steel

① High frequency connections.

② High frequency connections operating at high temperature. By their small dimensions, they are mainly designed for miniaturized connections, operating at high or low temperature.

75 Ω KX & RG coaxial cables

Operating temperature Min/Max	Fire properties	Max. op. frequency GHz	Nominal capacitance pF/m	Attenuation (db/100 m)				Dielectric strength kV	Powers at 40°C (kw)				Velocity of propagation	Continuous working voltage
				200 MHz	400 MHz	3000 MHz	10000 MHz		200 MHz	400 MHz	3000 MHz	10000 MHz		
-40 +85	NF C 32070/C2 IEC 60332 – 1&2	1	72.2	16	23	73		7	0.17	0.12	0.042		65.9	1700
-40 +85	NF C 32070/C2 IEC 60332 – 1&2	3	67.0	16	23	73		4.2	0.17	0.12	0.042		65.9	1700
-40 +85	NF C 32070/C2 IEC 60332 – 1&2	1	72.2	9.5	13	45		10	0.42	0.3	0.095		65.9	3700
-40 +85	NF C 32070/C2 IEC 60332 – 1&2	3	72.2	9.5	13	45		10	0.42	0.3	0.095		65.9	3700
-40 +85	NF C 32070/C2 IEC 60332 – 1&2	3	67.0	9.5	13	45		8	0.42	0.3	0.095		65.9	3700
-90 +200	NF C 32070/C1&C2 IEC 60332 – 1	3	75.5	40	56	160		2	0.17	0.11	0.032		69.5	900
-90 +230	NF C 32070/C1&C2 IEC 60332 – 1	3	72.2	40	56	160		2	0.17	0.11	0.032		69.5	900

93-95 Ω KX & RG coaxial cables

Operating temperature Min/Max	Fire properties	Max. op. frequency GHz	Nominal capacitance pF/m	Attenuation (db/100 m)				Dielectric strength kV	Powers at 40°C (kw)				Velocity of propagation	Continuous working voltage
				200 MHz	400 MHz	3000 MHz	10000 MHz		200 MHz	400 MHz	3000 MHz	10000 MHz		
-40 +85	NF C 32070/C2 IEC 60332 – 1&2	1	47.6	14	22	100		3					83.0	750
-90 +200	NF C 32070/C1&C2 IEC 60332 – 1	3	50.5	30	43	120		2	0.35	0.25	0.08		69.5	900
-90 +230	NF C 32070/C1&C2 IEC 60332 – 1	3	50.5	30	43	120		2	0.35	0.25	0.08		69.5	900

Other standard cables

Impedance	Max. op. temp.	Dielectric	References according to		Nexans ref.	CONDUCTOR			Dielectric Ø mm	BRAIDS		SHEATH		Av. weight kg/km
			NF. C 93-550	MIL C17		Composition n x Ø mm	Nature	Ø mm		Nb	Nature	Nature	Overall Ø mm	

CABLES with two CONDUCTORS

78 Ω	85°C	PE		RG 108 AU	087061	7 x 0.32	TPC	0.96	2.0	1	TPC	PVC	6.0 ± 0.25	52
95 Ω	85°C	PE		RG 22 BU	087043	7 x 0.38	TPC	1.14	2.3	2	TPC	PVC	10.7 ± 0.25	181

TPC : tin plated copper

Reference	Op. temp. (min/max)	Fire properties	Max. op. frequency GHz	Nominal capacitance pF/m	Attenuation (db/100 m)				Dielectric strength kV	Velocity of propagation	Continuous working voltage
					1 MHz	10 MHz	200 MHz	400 MHz			

RG 108 AU	-40 +85	NF C 32070/C2 IEC 60332 – 1&2	1	64.8		10	60	95	2	65.9	750
RG 22 BU	-40 +85	NF C 32070/C1 IEC 60332 – 1		53.2		5	20	29	2		

Application: High frequency connections. These twinaxial cables are mainly designed for digital data transmissions in electronic systems.

DATA BUS CABLE

M17/176-00002

Applications

Bus lines for multiplexed transmissions.
The cable is constructed with 2 cores and 2 fillers twisted together.

77 Ω data bus cable

Construction

1- CONDUCTOR

Stranded, high strength silver plated copper alloy

2- INSULATION

Extruded PTFE

3- FILLERS

Extruded PTFE

4- SCREEN

High strength silver plated copper alloy

5- SHEATH

PFA

Colour : translucent blue

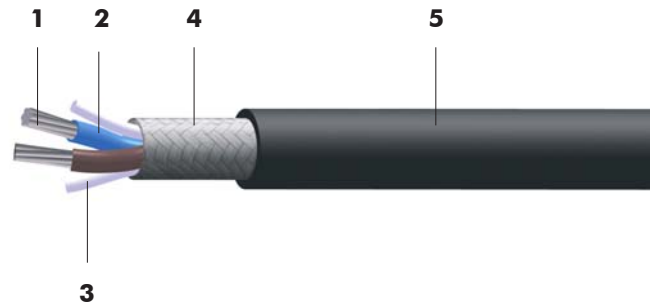

Identification

1 blue core and 1 white core

Standards

M17/176-00002

Minimum bending radius

21 mm



■ M17/176-00002 data bus cable

Impedance	Max. op. temp.	Dielectric	Nexans reference	CONDUCTOR		Dielectric Ø mm	BRAIDS		SHEATH		Av. weight kg/km
				Composition n x Ø mm	Nature		Nb	Nature	Nature	Overall Ø mm	
77 Ω	200°C	PTFE	090612	19 x 0.13	SPC alloy	1.07	1	SPC alloy	PFA	3.27 ± 0.127	26

Nexans reference	Max. op. frequency GHz	Nominal capacitance pF/m	Attenuation at 1 MHz (db/m)	Continuous working voltage
090612	1	65	4.6	750

HALOGEN FREE COAXIAL CABLES

FLAMEX KX/RG

Applications

Nexans produces a range of halogen free coaxial cables for data transmission and video signal in on-board equipments.

50 Ω and 75 Ω coaxial cables

Construction

1- Conductor

Stranded or solid, in bare copper (BC), tin plated copper (TPC), silver plated copper (SPC) or copper clad steel (CCS)

2- Dielectric

PE.

3- Screen

Single or double braid in bare, tinned or silvered copper

4- Sheath

Halogen free

Colour: black

Lay up with fire barrier tapes (in option).

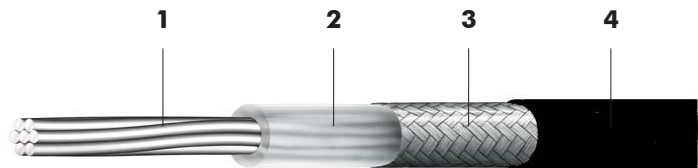

Marking

"FILOTEX P FLAMEX RG XXX" (cable type) in white marking.

Minimum bending radius

Static use : 5 x outer diameter

Standards

Approved Bureau Veritas, MIL C 17 (RG) except attenuation values.

Connectors

Compatible with standard connectors : SMA, SMB, TNC, BNC, N...

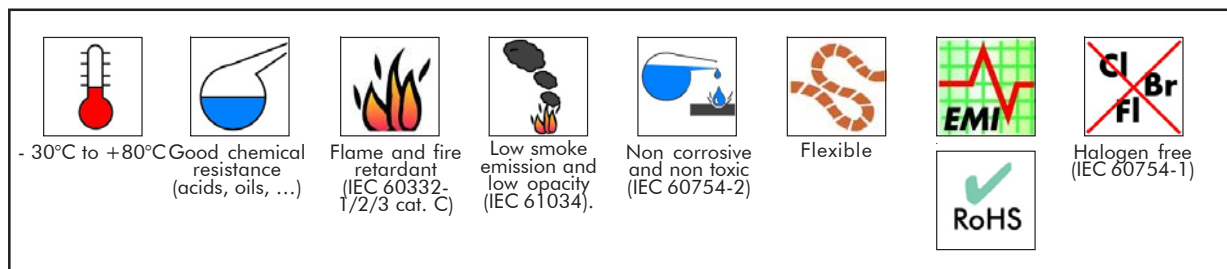

FLAMEX 50 Ω Halogen free coaxial cables

Nexans designation	Nexans reference	CONDUCTOR			Dielectric Ø mm	BRAIDS		SHEATH		Av. weight kg/km	Max. op. frequency GHz	Continuous working voltage
		Composition n x Ø mm	Nature	Ø mm		Nb	Nature	Nature	Overall Ø mm			
FLAMEX KX 3B	ET 299946	7x0.16	CCS	0.48	1.50 ± 0.10	1	TPC	FLAMEX	2.54 ± 0.13	10	3	1100
FLAMEX RG 174	ET 299956	7x0.16	CCS	0.48	1.52 ± 0.08	1	TPC	FLAMEX	2.79 ± 0.13	12.5	1	1100
FLAMEX RG 58	ET 299954	19x0.18	TPC	0.90	2.95 ± 0.10	1	TPC	FLAMEX	4.95 ± 0.10	41	3	1400
FLAMEX RG 213	ET 299957	7x0.75	BC	2.25	7.24 ± 0.18	1	BC	FLAMEX	10.30 ± 0.18	165	3	3700
FLAMEX RG 214	ET 299958	7x0.75	SPC	2.25	7.24 ± 0.18	2	SPC	FLAMEX	10.80 ± 0.18	198	11	3700

Capacitance : < 106 pF / m

Velocity of propagation : 65.9%

FLAMEX 75 Ω Halogen free coaxial cables

Nexans designation	Nexans reference	CONDUCTOR			Dielectric Ø mm	BRAIDS		SHEATH		Av. weight kg/km	Max. op. frequency GHz	Continuous working voltage
		Composition n x Ø mm	Nature	Ø mm		Nb	Nature	Nature	Overall Ø mm			
FLAMEX KX 6A	ET 299952	7x0.20	BC	0.60	3.70 ± 0.12	1	BC	FLAMEX	6.10 ± 0.15	57	3	1700
FLAMEX RG 59	ET 299955	1x0.57	CCS	0.57	3.71 ± 0.10	1	BC	FLAMEX	6.15 ± 0.10	58	1	1700
FLAMEX RG 11	ET 299953	7x0.40	TPC	1.20	7.24 ± 0.18	1	BC	FLAMEX	10.30 ± 0.18	146	1	3700
FLAMEX KX 8	ET 299951	7x0.40	BC	1.20	7.25 ± 0.15	1	BC	FLAMEX	10.30 ± 0.20	145	3	3700
FLAMEX RG 216	ET 299965	7x0.40	TPC	1.20	7.24 ± 0.18	2	BC	FLAMEX	10.80 ± 0.18	185	3	3700

Capacitance : < 72.2 pF / m

Velocity of propagation : 65.9%

BC: bare copper, TPC: tin plated copper, SPC : silver plated copper, CCS: copper clad steel

Attenuation values

Designation	Nexans ref.	Attenuation at x MHz in db/100m (nominal values)						
		50	100	200	400	1000	3000	11000
50 Ω	FLAMEX KX 3B			45				
	FLAMEX RG174	21.32	32.8		82.02	147.63		
	FLAMEX RG58	13.12	21.32		55.77	91.86		
	FLAMEX RG213	3.93	7.54		15.74	29.52		
	FLAMEX RG214	5.57			22.3		91.86	196.85
75 Ω	FLAMEX KX6A			20				
	FLAMEX RG59				29.52	52.48		
	FLAMEX RG 11				17.06	30.84		
	FLAMEX KX8			12				
	FLAMEX RG 216				21.32	75.45		

TELECOM COAXIAL CABLES

RG types

Applications

These coaxial cables are mainly designed for high frequency interconnections in telecommunication equipments. If a high shielding effectiveness is required, use the double braided cables.

50 Ω and 75 Ω coaxial cables

Construction

1- CONDUCTOR

Stranded or solid, in copper clad steel (CCS) or silver plated copper covered steel (SPCCS)

2- DIELECTRIC

PE, FEP, PTFE.

3- SCREEN

Single or double braid in bare copper or silver plated copper

4- SHEATH

PVC, FEP or halogen free

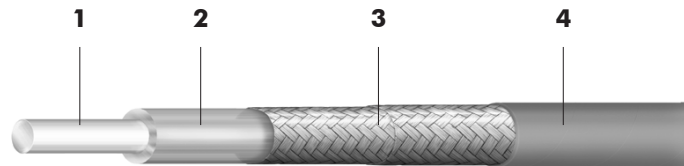

Physical properties

Very good resistance to solvents (except halogen free versions)
Very good resistance to soldering operations

For halogen free versions (LSZH):

- pH > 4 and conductivity < 100mS/cm according to IEC 754-1
- VW-1 and FT-1 according to UL and CSA standards
- Low smoke emissions according to IEC 1034-2

Minimum bending radius

Static use : 5 x outer diameter

Standards

NEXANS specification

Connectors

Compatible with all standard connectors intended for RG cables

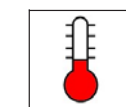

See on the following page



See on the following page



Flexible



EMI



RoHS

50 Ω telecom coaxial cables

Max. op. temp.	Dielectric	Nexans designation	Nexans reference	CONDUCTOR			Dielectric Ø mm	BRAIDS		SHEATH		Av. weight kg/km
				Composition n x Ø mm	Nature	Ø mm		Nb	Nature	Nature	Overall Ø mm	
80°C	Polyolefine	RG 316 ST LSZH	2PB272	7 x 0.17	SPCCS	0.51	1.52	1	SPC	Zero HAL	2.50 ± 0.10	10.8
		RG 316 DT LSZH	2PB273	7 x 0.17	SPCCS	0.51	1.52	2	SPC	Zero HAL	2.94 ± 0.15	18.2
		RG 142 DT LSZH	2PB274	1 x 0.95	SPCCS	0.95	2.95	2	SPC	Zero HAL	4.95 ± 0.13	45.6
180°C	FEP	RG 316 ST FEP	296891	7 x 0.17	SPCCS	0.5	1.50	1	SPC	FEP	2.50 ± 0.10	13.8
		RG 316 DT FEP	296892	7 x 0.17	SPCCS	0.5	1.50	2	SPC	FEP	2.90 ± 0.10	19.8
200°C	PTFE	RG 178 PTFE	111336	7 x 0.10	SPCCS	0.30	0.84	1	SPC	FEP	1.80 ± 0.10	8.3
		RG 316 ST PTFE	124467	7 x 0.17	SPCCS	0.5	1.50	1	SPC	FEP	2.50 ± 0.10	12.0
		RG 316 DT PTFE	124376	7 x 0.17	SPCCS	0.5	1.50	2	SPC	FEP	2.90 ± 0.10	19.6
		RG 142 DT PTFE	124380	1 x 0.95	SPCCS	0.95	2.95	2	SPC	FEP	4.95 ± 0.13	66.1

75 Ω telecom coaxial cables

Max. op. temp.	Dielectric	Nexans designation	Nexans reference	CONDUCTOR			Dielectric Ø mm	BRAIDS		SHEATH		Av. weight kg/km
				Composition n x Ø mm	Nature	Ø mm		Nb	Nature	Nature	Overall Ø mm	
80°C	Polyolefine	RG 179 ST LSZH	2PB270	7 x 0.10	SPCCS	0.30	1.60	1	SPC	Zero HAL	2.54 ± 0.13	12.3
		RG 179 DT LSZH	2PB271	7 x 0.10	SPCCS	0.30	1.60	2	SPC	Zero HAL	3.00 ± 0.15	15.8
	PE	RG 179 ST PE/PVC	288108	1 x 0.25	CCS	0.25	1.50 ± 0.10	1	BC	PVC	2.80 ± 0.12	12.6
		RG 179 DT PE/PVC	2PB389	1 x 0.25	CCS	0.25	1.50 ± 0.10	2	BC	PVC	3.20 ± 0.15	22.2
180°C	FEP	RG 179 ST FEP	296469	7 x 0.10	SPCCS	0.30	1.60	1	SPC	FEP	2.54 ± 0.13	15.7
		RG 179 DT FEP	2PA030	7 x 0.10	SPCCS	0.30	1.60	2	SPC	FEP	3.07 ± 0.10	25.3
200°C	PTFE	RG 179 ST PTFE	125480	7 x 0.10	SPCCS	0.30	1.60	1	SPC	FEP	2.54 ± 0.13	15.8
		RG 179 DT PTFE	124431	7 x 0.10	SPCCS	0.30	1.60	2	SPC	FEP	3.07 ± 0.10	22.6

BC: bare copper, TPC: tin plated copper, SPC: silver plated copper, CCS: copper clad steel, SPCCS: silver plated copper covered steel

June 2006 - Copyright Nexans

■ 50 Ω telecom coaxial cables

Temp. De service (min/max)	Tenue au feu	Fréquence d'ut. Maxi. GHz	Capacité nominale pF/m	Affaiblissement moyen (db/100 m)						Vitesse de propagation	Tension de service Volts
				10 MHz	100 MHz	1000 MHz	900 MHz	1800 MHz	3000 MHz		
-25 +80	NF C 32070/C1 IEC 60332 - 1	3	95				86	120	160	70	900
-25 +80	NF C 32070/C1 IEC 60332 - 1	3	95				86	120	160	70	900
-25 +80	NF C 32070/C1 IEC 60332 - 1	3	95				43	62	82	70	1500
-90 +180	NF C 32070/C1&C2 IEC 60332 - 1	3	95				80	120		69.5	900
-90 +180	NF C 32070/C1&C2 IEC 60332 - 1	3	95				80	120		69.5	900
-90 +200	NF C 32070/C1&C2 IEC 60332 - 1	3	95				150	240		69.5	750
-90 +200	NF C 32070/C1&C2 IEC 60332 - 1	3	95				80	120		69.5	900
-90 +200	NF C 32070/C1&C2 IEC 60332 - 1	3	95				80	120		69.5	900
-90 +200	NF C 32070/C1&C2 IEC 60332 - 1	3	95				40	60		69.5	1400

■ 75 Ω telecom coaxial cables

Temp. de service (min/max)	Tenue au feu	Fréquence d'ut. maxi. GHz	Capacité nominale pF/m	Affaiblissement moyen (db/100 m)						Vitesse de propagation	Tension de service Volts
				10 MHz	100 MHz	1000 MHz	900 MHz	1800 MHz	3000 MHz		
-25 +80	NF C 32070/C1 IEC 60332 - 1	3	64				100	140	185	70	900
-25 +80	NF C 32070/C1 IEC 60332 - 1	3	64				100	140	185	70	900
-20 +80	NF C 32070/C1 IEC 60332 - 1	3	67	8.5	28	89				66	900
-20 +80	NF C 32070/C1 IEC 60332 - 1	3	67	8.5	28	89				66	900
-90 +180	NF C 32070/C1&C2 IEC 60332 - 1	3	64				80	120		69.5	900
-90 +180	NF C 32070/C1&C2 IEC 60332 - 1	3	64				90	140		69.5	900
-90 +200	NF C 32070/C1&C2 IEC 60332 - 1	3	64				80	120		69.5	900
-90 +200	NF C 32070/C1&C2 IEC 60332 - 1	3	64				80	120		69.5	900

LOW NOISE COAXIAL CABLES

CAS 85-22P
CAS 250-20 P
CAS 250-20 SP
CAS 250-22

Applications

Cables designed for low frequency connections submitted to displacements and vibrations during their operation.

250/600 Volts RMS

Construction

1- CONDUCTOR

Stranded or solid in silver plated copper covered steel (SPCCS)

2- DIELECTRIC

PE or PTFE

3- ANTIMICROPHONIC NOISE COATING

4- SCREEN

Single braid in bare copper or silver plated copper

5- SHEATH

PVC or PTFE tape(s)

Colour: green for standard version.

Other colours on request.

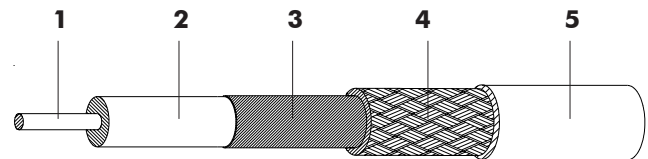

Bending radius

Static use : 10 x outer diameter

Standards

NEXANS specification

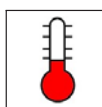

Up to +200°C



Flexible



RoHS

Low noise coaxial cables

Dielectric	Designation	Nexans reference	CONDUCTOR			Dielectric Ø mm	BRAIDS		SHEATH	
			Composition n x Ø mm	Nature	Ø mm		Nb	Nature	Nature	Overall Ø mm
PE	CAS 85-22P	87067	1 x 0.30	SPCCS	0.30	1.10 ± 0.05	1	BC	PVC	2.15 ± 0.05
PTFE	CAS 250-20 P	87208	1 x 0.30	SPCCS	0.30	1.05 ± 0.05	1	SPC	PTFE	1.90 ± 0.10
PTFE	CAS 250-20 SP	87209	7 x 0.10	SPCCS	0.30	1.05 ± 0.05	1	SPC	PTFE	1.90 ± 0.10
PTFE	CAS 250-22	87068	1 x 0.30	SPCCS	0.30	0.98 ± 0.05	1	SPC	PTFE	2.15 ± 0.05

Designation	Nexans reference	Average Weight kg/km	Nominal capacitance pF/m	Velocity of propagation	Continuous working voltage	Triboelectric low noise level
CAS 85-22P	87067	8.0	95	70	600	<200 µvolts
CAS 250-20 P	87208	8.9	90	76	600	<200 µvolts
CAS 250-20 SP	87209	8.8	90	76	600	<200 µvolts
CAS 250-22	87068	11.6	90	76	250	<200 µvolts

MINIATURE COAXIAL CABLES

50 VMTX
75 VMTX

Applications

Miniaturized coaxial cables for high frequency transmissions.

50 Ω and 75 Ω coaxial cables

Construction

1- CONDUCTOR

Solid in silver plated copper covered steel (SPCCS)

2- DIELECTRIC

Extruded PTFE

3- SCREEN

Single braid in silver plated copper

4- SHEATH

FEP



Physical properties

Very good resistance to solvents
Very good resistance to soldering operations

Standards

NEXANS specification

Bending radius

Static use : 10 x outer diameter

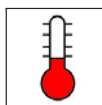

-90 to +200°C



Flexible



RoHS

■ Miniature coaxial cables

Impedance	Dielectric	Designation	Nexans reference	CONDUCTOR			Dielectric Ø mm	BRAIDS		SHEATH	
				Composition n x Ø mm	Nature	Ø mm		Nb	Nature	Nature	Overall Ø mm
50 Ω	PTFE	50 VMTX	87059	1 x 0.17	SPCCS	0.17	0.52 ± 0.03	1	SPC	FEP	1.17 ± 0.05
75 Ω	PTFE	75 VMTX	87060	1 x 0.10	SPCCS	0.10	0.57 ± 0.05	1	SPC	FEP	1.22 ± 0.05

Designation	Nexans reference	Average Weight kg/km	Max. op. frequency GHz	Nominal capacitance pF/m	Attenuation (db/100 m)						Velocity of propagation	Continuous working voltage
					10 MHz	100 MHz	400 MHz	1000 MHz	2000 MHz	3000 MHz		
50 VMTX	87059	3	3	85	22	54	115	220	320	450	69.5	250
75 VMTX	87060	3	3	60	36	70		220	320	390	69.5	250

HAND FORMABLE COAXIAL CABLES

Quickform® 86 and 141

Applications

QUICKFORM® coaxial cables are specially recommended for high frequency connections (mobile phone equipment, radio beams, radar...).

Quickform® could be listed Style UL1354 if requested.

The Quickform® 86 is a substitute to M17/133-RG405.
The Quickform® 141 is a substitute to M17/133-RG402.

The special outer conductor allows to change the shape of the assembly; nevertheless, they are intended for static use.

50 Ω coaxial cables

Construction

1- CONDUCTOR

Silver plated copper clad steel

2- DIELECTRIC

PTFE

3- OUTER CONDUCTOR

Tin soaked braid



Properties

Quickform® coaxial cables have electrical performances close to those of semi-rigid cables (very low attenuation very high screening effectiveness) but with easy and economical processing :

- no need for drawing of the assembly,
- manual shaping with or without pattern,
- no previous stabilisation,
- fast connection with all types of connectors intended for standard semi-rigid cables.

Standards

NEXANS specification
IEC 61196-1
IEC 61196-2

Minimum bending radius

Static use: 7 mm (Quickform® 86), 11 mm (Quickform® 141)

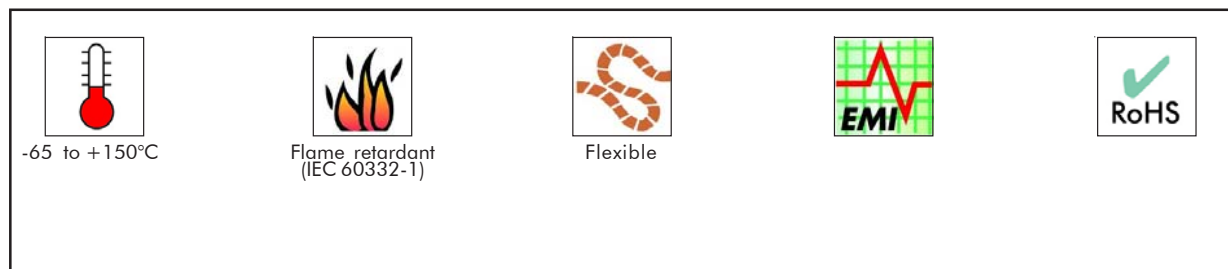

■ Hand formable coaxial cables

Impedance	Dielectric	Designation	Nexans reference	CONDUCTOR			Dielectric Ø mm	OUTER CONDUCTOR		Av. weight kg/km
				Composition n x Ø mm	Nature	Ø mm		Nature	Overall Ø mm	
50 Ω	PTFE	QF86 Cw PTFE	296380	1 x 0.51	SPCCS	0.51	1.60	Tin soaked braid	2.11	16.5
	PTFE	QF141 Cw PTFE	296379	1 x 0.92	SPCCS	0.92	2.98	Tin soaked braid	3.50	43.8

Nexans reference	Maximum operating frequency GHz	Capa. (pF/m)	Relative velocity of propagation (%)	Nominal attenuation (dB/m) at									
				0.1 GHz	0.3 GHz	1 GHz	2 GHz	3 GHz	5 GHz	10 GHz	15 GHz	20 GHz	26 GHz
296380	26	97	70	0.22	0.39	0.74	1.08	1.37	1.83	2.71	3.43	4.10	4.80
296379	26	97	70	0.12	0.21	0.42	0.64	0.82	1.12	1.70	2.22	2.61	3.13

Part 2
Single core and
multicore cables

80°C

Applications

These wires are designed for flexible connections submitted to a very high voltage.

4 000 Volts up to 12 000 Volts RMS

Construction

1 - CONDUCTOR

stranded annealed tinned copper wires

2 - INSULATION

polyethylene

3 - OUTER JACKET

polyvinyl chloride(PVC)

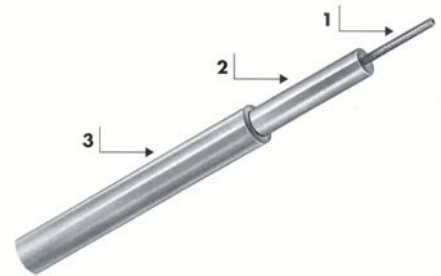

Standards

NEXANS specification

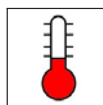

- 20°C to +80°C



Flame retardant
(NF C 32-070/C2)



Flexible



RoHS

■ HT - High voltage hook-up wires

Nexans Reference	CONDUCTOR			Nom. Ø over insulation mm	Overall Ø mm	Average weight Kg/km	Electrical Characteristics	
	Gauge AWG	Cross section mm ²	Construction n x Ø mm				Operating voltage V.RMS	Test voltage V.CA
HT 306 E	20	0.60	19 X 0.20	2.3	3.1 ± 0.2	14	4000	7000
HT 406 E	20	0.60	19 X 0.20	3.0	4.2 ± 0.2	20	5000	10000
HT 610 E	16	1.34	19 X 0.30	4.5	6.2 ± 0.3	44	7000	12000
HT 810 E	16	1.34	19 X 0.30	6.0	8.2 ± 0.3	72	12000	20000

UL 1007 Hook-up wires

Applications

Those wires are mainly designed for internal wiring in electrical and electronic equipments.

They are well suited to work under stringent conditions.

They are both UL and RoHS qualified. They can be used in all equipments in Europe or world wide.

300 volts

Construction

1 - AME

stranded tinned copper wires

2 - ISOLATION

Polyvinyl chloride (PVC-UL)

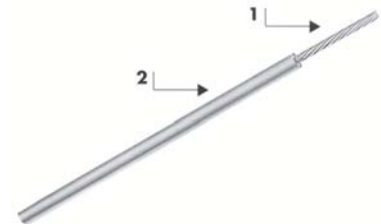

Standards

UL AWM Style 1007

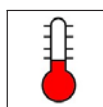

-40 °C to +80°C



Flame retardant
UL VW-1



Flexible



RoHS

■ UL 1007 - Hook-up wires

Nexans Reference	CONDUCTOR			Overall diameter mm
	Gauge AWG	Cross section mm ²	Construction n x Ø mm	
UL 1007 300V 80 °C	28	0.09	7 x 0.13	1.20 ± 0.05
UL 1007 300V 80 °C	26	0.14	7 x 0.16	1.30 ± 0.05
UL 1007 300V 80 °C	24	0.25	19 x 0.13	1.45 ± 0.05
UL 1007 300V 80 °C	22	0.38	19 x 0.16	1.60 ± 0.10
UL 1007 300V 80 °C	20	0.6	19 x 0.20	1.80 ± 0.10
UL 1007 300V 80 °C	18	0.93	19 x 0.25	2.20 ± 0.10
UL 1007 300V 80 °C	16	1.3	19 x 0.30	2.35 ± 0.10

FM & FMA

Screened and jacketed hook-up wires and multicore cables for low frequency applications

Applications

These flexible cables are specially designed for equipment wiring requiring a good efficient screen. For a reduced overall diameter, use FMA range.

Some typical applications:

- outdoor and indoor audio installations,
- microphone connections,
- wiring in equipment requiring efficient shielding against low frequency interference and inductive coupling.

250 volts for AWG 24 gauges
750 volts for AWG 22 gauges

Construction

1 - CONDUCTOR

stranded tinned copper wires

2 - INSULATION

polyethylene (Pe) or polyvinyl chloride (PVC) according to the products

3- SCREEN

tinned copper braid

4- OUTER JACKET



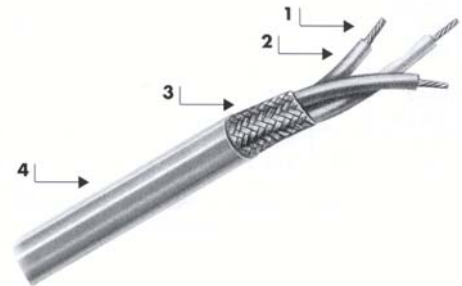

flexible polyvinyl chloride (PVC)

NOTA: the items with the FILOTEX reference ending by "PS" only have a PVC sheath as filler between cores and screen.



Standards

NEXANS specification

 <p>- 20°C to +80°C</p>	 <p>Flame retardant (NF C 32-070/C2)</p>	 <p>Flexible</p>	 <p>EMI</p>	 <p>RoHS</p>
--	---	---	--	---

■ FM & FMA - Screened and jacketed hook-up wires and multicore cables

Nb. of cores	Nexans Reference	BASE CORE				Overall diameter		Average weight Kg / Km	Colour coding of cores
		CONDUCTOR			Nom. Ø core mm	mini.	maxi.		
		Gauge AWG	Cross section mm ²	Construction n x Ø mm		mm			
1	FM 1R	24	0.22	7 x 0.20	1.2	2.3	2.7	10	White
1	FMA 1R	24	0.22	7 x 0.20	1.1	2.1	2.5	10	White
1	FM 1M	24	0.22	7 x 0.20	1.6	3.3	3.7	18	White
1	FMA 1M	24	0.22	7 x 0.20	1.5	2.6	3.0	13	White
1	FM 1	22	0.38	12 x 0.20	2.5	4.7	5.3	35	White
1	FMA 1	22	0.34	7 x 0.25	2.0	3.2	3.6	19	White
1	FM 1P	22	0.38	12 x 0.20	2.5	4.7	5.3	34	Natural
1	FMA1P	22	0.34	7 x 0.25	2.0	3.2	3.6	18	Natural
2	FM 2 R	24	0.22	7 x 0.20	1.2	3.8	4.2	24	White, Blue
2	FMA 2 R	24	0.22	7 x 0.20	1.1	3.5	3.9	19	White, Blue
2	FM 2 M	24	0.22	7 x 0.20	1.5	4.7	5.3	34	White, Yellow
2	FMA 2 M	24	0.22	7 x 0.20	1.5	4.4	4.8	26	White, Yellow
2	FM 2	22	0.38	12 x 0.20	2.0	5.7	6.3	49	White, Blue
2	FMA2	22	0.34	7 x 0.25	2.0	5.3	5.9	39	White, Blue
2	FM 2 P	22	0.38	12 x 0.20	2.0	5.7	6.3	45	Natural, Red
2	FMA 2 P	22	0.34	7 x 0.25	2.0	5.3	5.9	34	Natural, Red
2	FM 2 PS	22	0.31	40 x 0.10	2.2	7.7	8.3	90	White, Yellow
2	FMA 2PS	22	0.34	7 x 0.25	2.0	6.8	7.4	72	White, Yellow
3	FM 3 R	24	0.22	7 x 0.20	1.2	4.0	4.4	27	White, Blue, Red
3	FMA 3 R	24	0.22	7 x 0.20	1.1	3.7	4.1	18	White, Blue, Red
3	FM 3	22	0.38	12 x 0.20	2.0	5.7	6.3	49	White, Blue, Red
3	FMA3	22	0.34	7 x 0.25	2.0	5.6	6.2	32	White, Blue, Red
3	FM 3 PS	22	0.31	40 x 0.10	2.2	7.8	8.6	90	White, Yellow, Green
3	FMA 3 PS	22	0.34	7 x 0.25	2.0	7.1	7.7	79	White, Yellow, Green
4	FM 4 R	24	0.22	7 x 0.20	1.2	5.0	5.4	40	White, Blue, Red, Yellow
4	FMA 4 R	24	0.22	7 x 0.20	1.1	4.0	4.4	19	White, Blue, Red, Yellow
4	FM 4	22	0.38	12 x 0.20	2.0	6.7	7.3	71	White, Blue, Red, Yellow
4	FMA 4	22	0.34	7 x 0.25	2.0	6.3	6.9	23	White, Blue, Red, Yellow
4	FM 4 PS	22	0.31	40 x 0.10	2.2	8.1	8.9	104	White, Yellow, Green, Blue
4	FMA 4 PS	22	0.34	7 x 0.25	2.0	7.7	8.3	91	White, Yellow, Green, Blue
5	FM 5 R	24	0.22	7 x 0.20	1.2	5.6	6.0	48	White, Blue, Red, Yellow, Green
5	FMA 5 R	24	0.22	7 x 0.20	1.1	4.4	4.8	25	White, Blue, Red, Yellow, Green
5	FM 5	22	0.38	12 x 0.20	2.0	7.7	8.3	92	White, Blue, Red, Yellow, Green
5	FMA5	22	0.34	7 x 0.25	2.0	7.1	7.7	47	White, Blue, Red, Yellow, Green
6	FM 6 R	24	0.22	7 x 0.20	1.1	5.0	5.6	42	White, Blue, Red, Yellow, Green, Black
6	FMA 6 R	24	0.22	7 x 0.20	1.1	4.7	5.1	24	White, Blue, Red, Yellow, Green, Black
6	FM 6	22	0.38	12 x 0.20	2.0	8.3	9.1	54	White, Blue, Red, Yellow, Green, Black
6	FMA 6	22	0.34	7 x 0.25	2.0	7.7	8.5	52	White, Blue, Red, Yellow, Green, Black

The cables with the letter "P" in the reference (example FMA 2P) have the polyethylene insulated cores, the other cables have the PVC insulated cores.

EHE & EHEA

Screened and jacketed hook-up wires and multicore cables for low frequency

Applications

These flexible cables are mainly designed for use in applications requiring high efficiency screening at low frequencies. The screen is made up of a continuous high conductive thermoplastic sheath and provides a shielding efficiency inversely proportional to the frequency.

So a very high efficiency is obtained at industrial frequencies. For a reduced overall diameter, use EHEA range. Easy stripping, as well as grounding, because of the drain wire placed under the thermoplastic sheath.

250 Volts and 750 Volts according to the products

Construction

- 1 - CONDUCTOR**
stranded tinned copper wires
- 2 - INSULATION**
polyethylene (Pe)
- 3- DRAIN WIRE**
- 4- SCREEN**
high conductive sheath
- 5- OUTER JACKET**
flexible polyvinyl chloride (PVC)

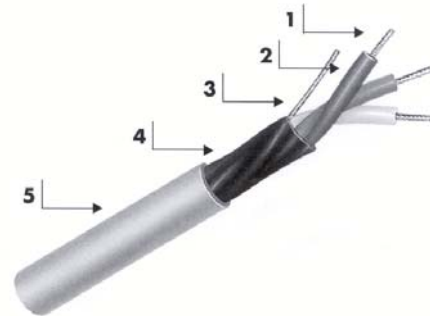

Standards

NEXANS specification

 <p>- 20°C to +80°C</p>	 <p>Flame retardant (NF C 32-070/C2)</p>	 <p>Flexible</p>	 <p>EMI</p>	 <p>RoHS</p>
--	---	---	--	---

EHE & EHEA - Screened and jacketed hook-up wires and multicore cables

Nb. of cores.	Nexans Reference	BASE CORE				Overall diameter		Average weight Kg / Km	Operating voltage	Colour coding of cores
		CONDUCTOR			Nominal Ø core mm	mini.	maxi.			
		Gauge AWG	Cross section mm ²	Construction n x Ø mm		mm				
1	EHEA1PR	24	0.22	7 x 0.20	1.1	2.4	2.8	8	250 V	Natural
1	EHEA1 PM	24	0.22	7 x 0.20	1.5	3.0	3.4	11	250 V	Natural
1	EHEA1P	22	0.34	7 x 0.25	2.0	3.4	3.8	14	750 V	Natural
2	EHE 2 PR	24	0.22	7 x 0.20	1.2	3.8	4.2	12	250 V	Natural, Blue
2	EHEA2PR	24	0.22	7 x 0.20	1.1	3.5	3.9	14	250 V	Natural, Blue
2	EHEA2PM	24	0.22	7 x 0.20	1.5	4.6	5.0	17	250 V	Natural, Yellow
2	EHE 2 PM	22	0.34	7 x 0.25	1.5	4.7	5.3	19	250 V	Natural, Yellow
2	EHE 2 P	22	0.38	12 x 0.20	2.0	5.5	6.1	22	750 V	Natural, Blue
2	EHEA2P	22	0.34	7 x 0.25	2.0	5.5	6.1	22	750 V	Natural, Blue
3	EHE 3 PR	24	0.22	7 x 0.20	1.2	4.0	4.4	14	250 V	Natural, Blue, Red
3	EHEA3 PR	24	0.22	7 x 0.20	1.1	3.8	4.2	13	250 V	Natural, Blue, Red
3	EHEA3 PM	24	0.22	7 x 0.20	1.5	4.8	5.4	18	250 V	Natural, Blue, Yellow
3	EHE 3 P	22	0.38	12 x 0.20	2.0	6.4	7.0	31	750 V	Natural, Blue, Red
4	EHE 4 PR	24	0.22	7 x 0.20	1.2	4.6	5.0	16	250 V	Natural, Blue, Red, Yellow
4	EHEA4 PR	24	0.22	7 x 0.20	1.1	4.2	4.6	14	250 V	Natural, Blue, Red, Yellow
4	EHEA4 PM	24	0.22	7 x 0.20	1.5	5.2	5.8	20	250 V	Natural, Blue, Red, Yellow
4	EHE 4 PM	22	0.34	7 x 0.25	1.5	5.5	6.1	26	250 V	Natural, Blue, Red, Yellow
5	EHEA5PR	24	0.22	7 x 0.20	1.1	4.6	5.0	15	250 V	Natural, Blue, Red, Yellow, Green
6	EHEA 6 PR	24	0.22	7x 0.20	1.1	4.9	5.3	16	250 V	Natural, Blue, Red, Yellow, Green, Black

SMA & SMBL

Unscreened and jacketed (SMA),
screened and jacketed (SMBL)
multicore cables

Applications

Flexible cables designed for internal wiring in equipment, found in many markets (instrumentation, process-control, remote control, electronic industrial equipment,...)

500 Volts RMS

Construction

1- CONDUCTOR

stranded tinned copper wires

2- INSULATION

flexible polyvinyl chloride (PVC)

3- LAY UP

polyester tape (for screened cables only)

4- SCREEN

tinned copper braid (for screened cables only)

5- OUTER JACKET

polyvinyl chloride (PVC)



Colour coding

Colour coding of the cores by plain colours and rings.

Standards

NEXANS specification

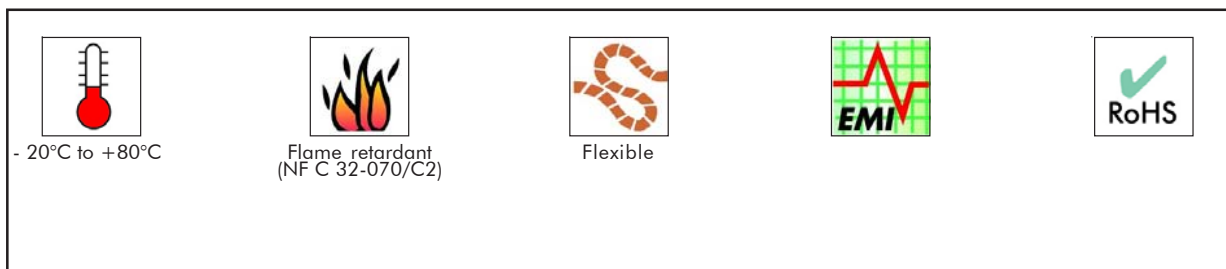

SMA - Unscreened and jacketed multicore cables

Nb. of cores	Nexans Reference	Cross section 0.22 mm ²			Cross section 0.34 mm ²			Cross section 0.60 mm ²		
		(AWG24)			(AWG22)			(AWG20)		
		Ø	+/-	Average weight	Ø	+/-	Average weight	Ø	+/-	Average weight
		mm		Kg/Km	mm		Kg/Km	mm		Kg/Km
2	SMA 02x...	3.10	0.15	11.33	3.70	0.15	16.60	4.25	0.15	28.21
3	SMA03x...	3.30	0.15	14.84	3.80	0.15	20.70	4.70	0.15	36.87
4	SMA 04x...	3.70	0.15	19.37	4.25	0.15	27.00	5.30	0.20	47.33
5	SMA05x...	3.90	0.15	22.13	4.60	0.15	32.13	5.80	0.20	56.32
7	SMA07x...	4.20	0.15	28.98	5.00	0.15	42.74	6.25	0.20	72.61
10	SMA 10x...	5.55	0.20	43.85	6.25	0.20	59.41	8.15	0.20	99.56
12	SMA12x...	5.70	0.20	49.99	6.35	0.20	67.34	8.35	0.25	114.42
19	SMA19x...	6.40	0.20	70.30	7.50	0.25	102.14	9.70	0.25	170.20
27	SMA 27x...	7.80	0.25	100.83	9.50	0.25	153.58	11.50	0.25	234.71
37	SMA37x...	8.50	0.25	129.11	10.00	0.25	188.88	13.50	0.30	330.92

SMBL - Screened and jacketed multicore cables

Nb. of cores	Nexans Reference	Cross section 0.22 mm ²			Cross section 0.34 mm ²			Cross section 0.60 mm ²			Cross section 0.93 mm ²			Cross section 1.34 mm ²		
		(AWG24)			(AWG22)			(AWG20)			(AWG18)			(AWG16)		
		Ø	+/-	Av. weight	Ø	+/-	Av. weight	Ø	+/-	Av. weight	Ø	+/-	Av. weight	Ø	+/-	Av. weight
		mm		Kg/Km	mm		Kg/Km	mm		Kg/Km	mm		Kg/Km	mm		Kg/Km
2	SMBL 02x...	3.60	0.15	19.89	4.40	0.15	25.41	5.10	0.20	34.69	5.75	0.20	46.63	6.30	0.20	57.47
3	SMBL03x...	3.80	0.15	23.81	4.55	0.15	30.96	5.40	0.20	45.83	6.00	0.20	65.11	6.65	0.20	76.39
4	SMBL 04x...	4.10	0.15	29.24	5.00	0.15	38.59	5.90	0.20	57.01	6.80	0.20	78.38	7.40	0.25	99.80
5	SMBL05x...	4.40	0.15	32.40	5.65	0.20	49.38	6.50	0.20	68.84	7.30	0.25	93.45	8.20	0.25	121.82
7	SMBL07x...	4.90	0.15	45.29	5.80	0.20	61.40	6.90	0.20	92.43	8.00	0.25	122.12	9.00	0.25	160.78
10	SMBL 10x...	6.00	0.15	57.49	7.25	0.25	81.94	8.90	0.25	126.59	10.20	0.30	174.41	11.60	0.30	230.88
12	SMBL12x...	6.10	0.20	63.33	7.30	0.25	91.28	8.90	0.25	141.95	10.30	0.30	194.36	11.70	0.30	258.8
19	SMBL19x...	7.05	0.25	90.77	8.50	0.25	131.16	10.55	0.30	205.2	12.10	0.30	287.34	14.30	0.30	409.74
27	SMBL 27x...	8.75	0.25	129.78	9.90	0.25	175.04	12.80	0.30	294.79	14.90	0.30	418.65	17.40	0.35	576.29
37	SMBL37x...	9.45	0.25	160.87	11.10	0.30	229.01	14.30	0.30	384.18	16.40	0.35	539.74	19.50	0.40	759.42

Description of the core

CONDUCTOR				Ø
Cross section	Gauge	Construction	Insulation	
mm ²	AWG	n x Ø mm	mm	
0.22	24	7 x 0.20	1.04	
0.34	22	7 x 0.25	1.24	
0.60	20	19x0.20	1.65	
0.93	18	19 x 0.25	1.90	
1.34	16	19 x 0.30	2.27	

Example of ordering : SMA 7 x 0.34 ; SMBL 19 x 0.93

SMA/SMBL colour coding

Core. n°	Plain colour	Core n°	Plain colour/ Ring colour	Core. n°	Plain colour	Core n°	Plain colour/ Ring colour
1	White	11	White/Blue	21	Blue/Brown	31	Yellow/Green
2	Light Blue	12	White/Yellow	22	Blue/Black	32	Yellow/Grey
3	Yellow	13	White/Brown	23	Blue/Red	33	Yellow/Orange
4	Brown	14	White/Black	24	Blue/Green	34	Yellow/Purple
5	Black	15	White/Red	25	Blue/Grey	35	Brown/Black
6	Red	16	White/Green	26	Blue/Orange	36	Brown/Red
7	Green	17	White/Grey	27	Blue/Purple	37	Brown/Green
8	Grey	18	White/Orange	28	Yellow/Brown		
9	Orange	19	White/Purple	29	Yellow/Black		
10	Purple	20	White/Yellow	30	Yellow/Red		

GRTH & CCTB

Unscreened and jacketed (GRTH),
screened and jacketed (CCTB)
multicore cables

Applications

Flexible cables designed for internal wiring in equipment, operating at a maximum voltage of 750 V RMS, found in many markets (instrumentation, process-control, remote control, electronic industrial equipment...),

750 Volts RMS

Construction

1 - CONDUCTOR

stranded tinned copper wires

2 - INSULATION

flexible polyvinyl chloride (PVC)

3- LAY UP

polyester tape (for screened cables only)

4- SCREEN

tinned copper braid

5- OUTER JACKET

polyvinyl chloride (PVC)



Colour coding

Colour coding of the cores by plain colours and rings.

Standards

NEXANS specification

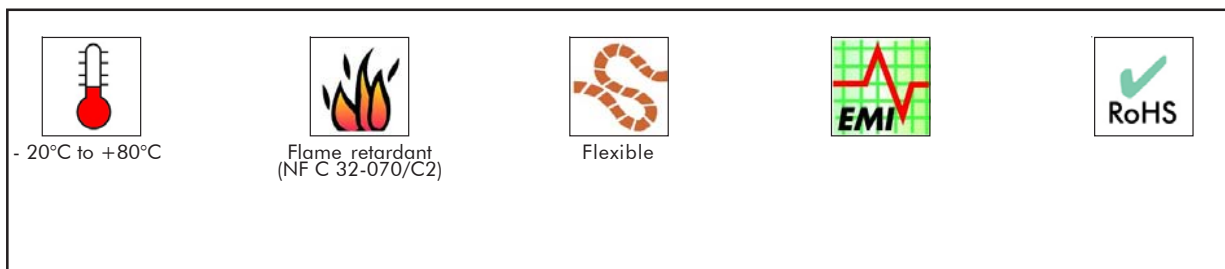

GRTH - Unscreened and jacketed multicore cables

Nb. of cores	Nexans Reference	Cross section 0.34 mm ² (AWG22)			Cross section 0.60 mm ² (AWG20)			Cross section 0.93 mm ² (AWG18)			Cross section 1.34 mm ² (AWG16)			Cross section 1.91 mm ² (AWG14)		
		Overall diameter		Average weight	Overall diameter		Average weight	Overall diameter		Average weight	Overall diameter		Average weight	Overall diameter		Average weight
		min.	max.		min.	max.		min.	max.		min.	max.		min.	max.	
		mm	Kg/Km	mm	Kg/Km	mm	Kg/Km	mm	Kg/Km	mm	Kg/Km	mm	Kg/Km			
2	GRTH 02x...	5.0	5.4	34	5.2	5.6	41	6.7	7.1	64	7.0	7.5	75	7.2	7.7	86
3	GRTH 03x...	5.2	5.6	38	5.7	6.1	50	6.9	7.4	74	7.4	7.9	94	7.8	8.3	109
4	GRTH 04x...	5.8	6.2	47	6.3	6.7	62	7.8	8.3	95	8.3	8.8	116	8.5	9.0	135
7	GRTH 07x...	7.2	7.7	74	7.8	8.3	99	9.0	9.5	138	9.0	9.5	147	10.6	11.2	221

CCTB - Screened and jacketed multicore cables

Nb. of cores	Nexans Reference	Cross section 0.60 mm ² (AWG20)			Cross section 0.93 mm ² (AWG18)			Cross section 1.34 mm ² (AWG16)			Cross section 1.91 mm ² (AWG14)		
		Overall diameter		Average weight	Overall diameter		Average weight	Overall diameter		Average weight	Overall diameter		Average weight
		min.	max.		min.	max.		min.	max.		min.	max.	
		mm	Kg/Km	mm	Kg/Km	mm	Kg/Km	mm	Kg/Km	mm	Kg/Km		
2	CCTB 02x...	6.0	6.4	57	6.9	7.4	64	7.3	7.8	90	8.0	8.5	113
3	CCTB03x...	6.4	6.8	66	7.3	7.8	87	7.8	8.3	106	8.6	9.1	134
4	CCTB 04x...	7.2	7.7	83	7.8	8.3	103	8.6	9.1	127	9.4	9.9	163
5	CCTB05x...	8.0	8.5	94	8.9	9.4	122	9.5	10.0	150	10.4	11.0	193
7	CCTB07x...	8.8	9.3	120	9.7	10.3	153	10.4	11.0	190	11.5	12.1	244

Description of the core

Conductor			Ø of core mm
Cross section	Gauge	Construction	
mm ²	AWG	n x Ø mm	
0.34	22	7 x 0.25	2.15 ± 0.15
0.60	20	19 x 0.20	2.35 ± 0.15
0.93	18	19 x 0.25	2.65 ± 0.15
1.34	16	19 x 0.30	2.85 ± 0.15
1.91	14	27 x 0.30	3.20 ± 0.20

Example of ordering : GRTH 02 x 0.34 ; CCTB 7 x 0.93

GRTH/CCTB colour coding

Cond. n°	Plain colour
1	Black
2	Light Blue
3	Brown*
4	Grey*
5	Orange*
6	Red*
7	Purple*

* From 3 cores, the last one is Yellow/Green
 - Example for 3 conductors : Black – Light blue – Yellow/Green

G250

**Flexible pairs
Screened with overall braid**

Applications

Interconnection cables for intercoms. Flexible links for low current and electronics use or where screening is required between circuits, mainly for data transmission.

250 Volts

Construction

1- CORE

stranded, 7x0.20 mm tinned copper

2- INSULATION

PVC

3- LAY UP

under polyester tape

4- SCREEN

tinned copper braid
K > 55%

5- OUTER JACKET

Very flexible PVC with a ripcord under the jacket.

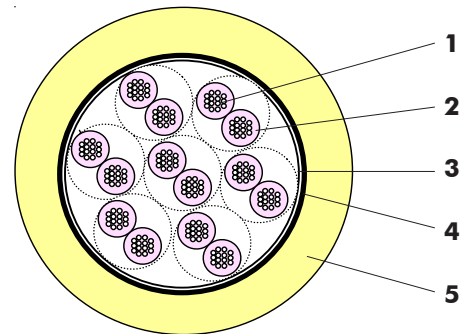

Colour coding

Colour coding of the cores by plain colours and rings.

Standards

NEXANS specification

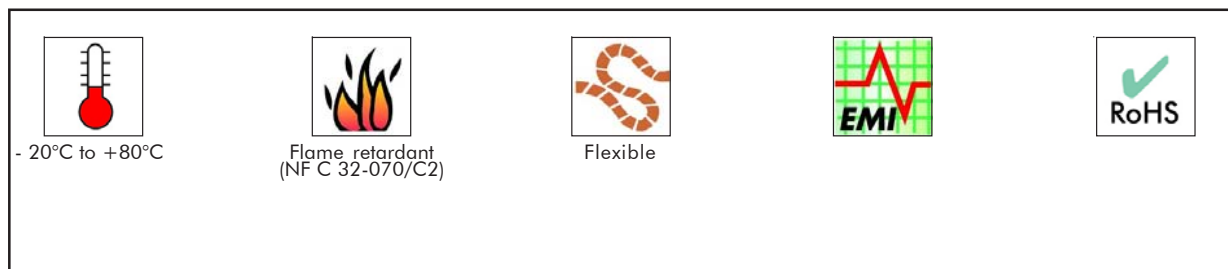

G250 - Flexible pairs, screened with overall braid

Nb of pairs	Nexans Reference	CORE			BRAID		Overall diameter		Average weight
		Gauge AWG	Cross section mm ²	Construction n x Ø mm	Ø strand	Ø mm	Ø mm	Tolerance mm	Kg/Km
2	G250-2/2	24	0.22	7 x 0.20	0.12	3.55	5.1	± 0.30	36
3	G250-3/2	24	0.22	7 x 0.20	0.12	4.00	5.50	± 0.40	44
5*	G250-5/2	24	0.22	7 x 0.20	0.12	5.1	6.6	± 0.40	64
7	G250-7/2	24	0.22	7 x 0.20	0.12	5.55	7.1	± 0.40	82
10	G250-10/2	24	0.22	7 x 0.20	0.13	6.60	8.1	± 0.40	106
12	G250-12/2	24	0.22	7 x 0.20	0.13	7.10	8.7	± 0.40	123
15	G250-15/2	24	0.22	7 x 0.20	0.13	7.95	9.6	± 0.50	147
21	G250-21/2	24	0.22	7 x 0.20	0.15	9.30	11.3	± 0.50	208
25	G250-25/2	24	0.22	7 x 0.20	0.15	10.40	12.7	± 0.40	242
30	G250-30/2	24	0.22	7 x 0.20	0.15	11.90	14.70	± 0.60	300

* PVC filler

Electrical characteristics

Attenuation	Value	Unit
Maximum loop resistance at 20°C	≤ 200	Ω/km
Insulation resistance at 20°C at 200 volts dc	≥ 500	MΩ.km

G250 colour coding

PAIR #	1	2	3	4	5	6	7	8	9	10
WIRE 1	Blue	Yellow	Brown	Black	Green	White/Blue	Yellow/Blue	Brown/Blue	Blue/Black	Green/Blue
WIRE 2	White	White	White	White	White	White	White	White	White	White

PAIR #	11	12	13	14	15	16	17	18	19	20
WIRE 1	White/ Yellow	Yellow/ Brown	Yellow/ Black	Yellow/ Green	White/ Brown	Brown/ Black	Brown/ Green	White/ Black	Green/ Black	White/ Green
WIRE 2	White	White	White	White	White	White	White	White	White	White

PAIR #	21	22	23	24	25	26	27	28	29	30
WIRE 1	Blue	Yellow	Brown	Black	Green	White/Blue	Yellow/Blue	Brown/Blue	Blue/Black	Green/Blue
WIRE 2	White/Red	White/Red	White/Red	White/Red	White/Red	White/Red	White/Red	White/Red	White/Red	White/Red

White/Blue = White ring Blue

G900

**Flexible pairs
with individual and overall screens
(tape+braid)**

Applications

Interconnection cables for intercoms when a high protection against electromagnetic interferences is required.
Flexible links for low current and electronics use or where screening is required between circuits, mainly for data transmission and telecom applications.

250 Volts

Construction

1- 2 CORES

Stranded, 7x0.25 mm tinned copper

Foam polyolefin insulation
Lay up under aluminium/
polyester tape

2- DRAIN WIRE

7x0.25 tinned copper

3- POLYESTER TAPE

4- SCREEN

Tinned copper braid
K>85%

5- OUTER JACKET

Flexible PVC.

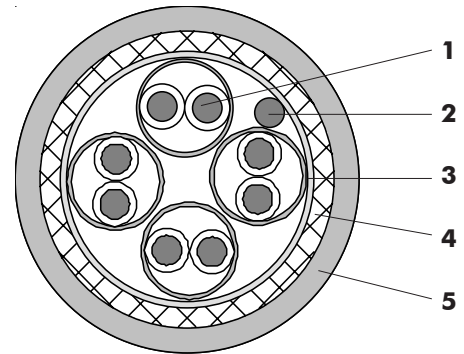

Colour coding

Colour coding of the cores by plain colours and rings.

Standards

NEXANS specification

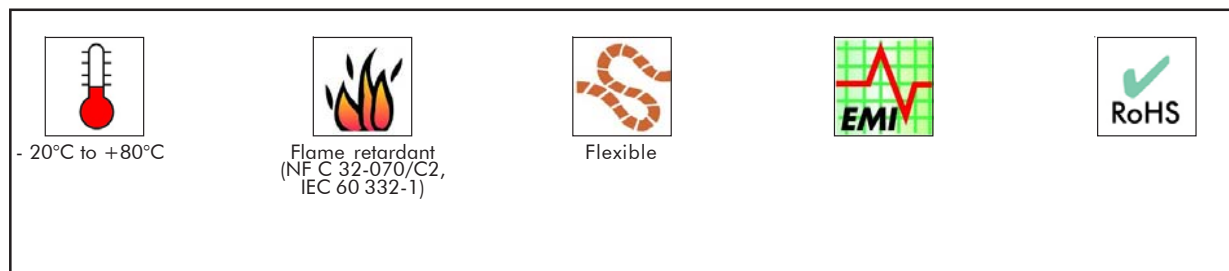

■ G900 - Flexible pairs with individual and overall screens

Nb of pairs	Nexans Reference	CORE			∅ over insulation mm	∅ over braid mm	Overall ∅ mm	Average weight Kg/Km
		Gauge AWG	Cross section mm ²	Construction n x ∅ mm				
1	G900-1/2	22	0.34	7 x 0.25	1.80	4.25	5.15	34
2	G900-2/2	22	0.34	7 x 0.25	1.80	7.10	8.40	67
3	G900-3/2	22	0.34	7 x 0.25	1.80	7.55	8.90	81
4	G900-4/2	22	0.34	7 x 0.25	1.80	8.40	9.85	99
5	G900-5/2	22	0.34	7 x 0.25	1.80	9.35	10.95	119
7	G900-7/2	22	0.34	7 x 0.25	1.80	10.30	12.05	150
8	G900-8/2	22	0.34	7 x 0.25	1.80	11.30	13.20	173
10	G900-10/2	22	0.34	7 x 0.25	1.80	13.50	15.70	221

■ Electrical characteristics

Attenuation	Value	Unit
Characteristic impedance at 1 MHz	100 ± 15	Ω
Nominal capacitance	35	nF/km
Conductor DC resistance	< 57	Ω/km
Insulation resistance	> 150	MΩ.km
NEXT at 1 MHz	> 50	dB
Dielectric strength	1000	V dc – 1 mn,

Attenuation at	1 MHz	5 MHz	10 MHz
in dB/100 m	3	5.5	7.5

■ G900 colour coding

PAIR #	1	2	3	4	5	6	7	8	9	10
WIRE 1	Blue	Yellow	Brown	Black	Green	White/Blue	Yellow/Blue	Brown/Blue	Blue/Black	Green/Blue
WIRE 2	White	White	White	White	White	White	White	White	White	White

SMA-ZH & SMBL-ZH

Unscreened and jacketed (SMA-ZH),
screened and jacketed (SMBL-ZH)
halogen free multicore cables

Applications

Flexible cables designed for internal wiring in equipment, found in many markets (instrumentation, process-control, remote control, electronic industrial equipment,...)

Halogen free, they are intended to be used in places where the protection of the people and equipment is vital.

We recommend to use them for cabinet wiring in public areas such as railway or subway stations but also in industrial areas, etc...

500 Volts RMS

Construction

1- CONDUCTOR

stranded tinned copper wires

2- INSULATION

Halogen free

3- LAY UP

polyester tape (for screened cables only)

4- SCREEN

tinned copper braid (for screened cables only)

5- OUTER JACKET

Halogen free



Colour coding

Colour coding of the cores by plain colours and rings.

Standards

NEXANS specification
These cables are UL 21283 qualified (80°C). They can be manufactured with an UL marking on request.

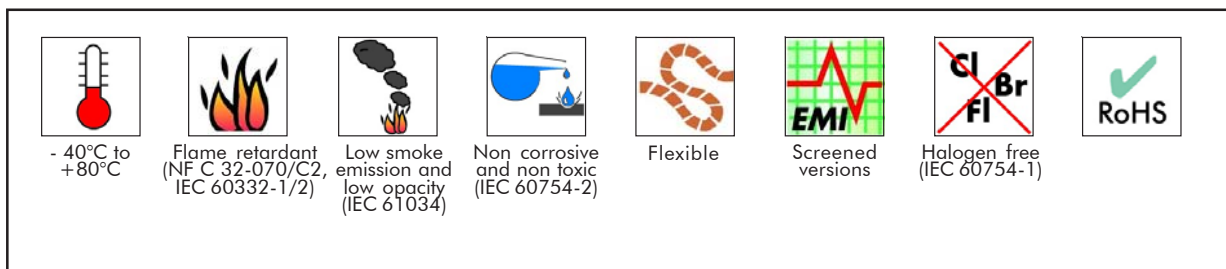

SMA-ZH - Unscreened and jacketed halogen free multicore cables

Nb. of cores	Nexans Reference	Cross section 0,22 mm ²			Cross section 0,34 mm ²			Cross section 0,60 mm ²			Cross section 0,93 mm ²		
		(AWG24)			(AWG22)			(AWG20)			(AWG18)		
		Ø	+/-	Av. weight	Ø	+/-	Av. weight	Ø	+/-	Av. weight	Ø	+/-	Av. weight
		mm		Kg/Km	mm		Kg/Km	mm		Kg/Km	mm		Kg/Km
2	SMA-ZH 02x...	3.10	0.40	12	3.70	0.40	17	4.25	0.40	23	4.70	0.40	31
3	SMA-ZH 03x...	3.30	0.40	15	3.80	0.40	21	4.70	0.40	33	5.10	0.40	43
4	SMA-ZH 04x...	3.70	0.40	20	4.25	0.40	28	5.30	0.40	43	5.50	0.40	53
5	SMA-ZH 05x...	3.90	0.40	22	4.60	0.40	33	5.80	0.40	52	6.25	0.40	68
7	SMA-ZH 07x...	4.20	0.40	28	5.00	0.40	42	6.25	0.40	67	7.15	0.50	96
12	SMA-ZH 12x...	5.70	0.40	49	6.35	0.40	65	8.35	0.50	111	9.60	0.50	161
19	SMA-ZH 19x...	6.40	0.40	67	7.50	0.50	98	9.70	0.50	164	11.40	0.60	245
27	SMA-ZH 27x...	7.80	0.50	96	9.50	0.50	147	11.50	0.50	223	13.85	0.60	347
37	SMA-ZH 37x...	8.50	0.50	121	10.00	0.50	178	13.50	0.60	316	15.60	0.60	465

SMBL-ZH - Screened and jacketed halogen free multicore cables

Nb. of cores	Nexans Reference	Cross section 0,22 mm ²			Cross section 0,34 mm ²			Cross section 0,60 mm ²			Cross section 0,93 mm ²		
		(AWG24)			(AWG22)			(AWG20)			(AWG18)		
		Ø	+/-	Av. weight	Ø	+/-	Av. weight	Ø	+/-	Av. weight	Ø	+/-	Av. weight
		mm		Kg/Km	mm		Kg/Km	mm		Kg/Km	mm		Kg/Km
2	SMBL-ZH 02x...	3.60	0.40	20	4.40	0.40	27	5.10	0.40	36	5.75	0.40	49
3	SMBL-ZH 03x...	3.80	0.40	24	4.55	0.40	32	5.40	0.40	47	6.00	0.40	61
4	SMBL-ZH 04x...	4.10	0.40	28	5.00	0.40	40	5.90	0.40	58	6.80	0.40	80
5	SMBL-ZH 05x...	4.40	0.40	32	5.65	0.40	51	6.50	0.40	70	7.30	0.50	95
7	SMBL-ZH 07x...	4.90	0.40	42	5.80	0.40	59	6.90	0.40	87	8.00	0.50	122
12	SMBL-ZH 12x...	6.10	0.40	62	7.00	0.50	88	8.90	0.50	140	10.30	0.60	193
19	SMBL-ZH 19x...	6.90	0.40	90	8.50	0.50	130	10.55	0.60	200	12.10	0.60	283
27	SMBL-ZH 27x...	8.75	0.50	126	9.90	0.50	170	12.80	0.60	290	14.90	0.60	412
37	SMBL-ZH 37x...	9.25	0.50	155	11.10	0.60	222	14.30	0.60	375	16.40	0.70	530

Description of the core

CONDUCTOR			Ø
Cross section	Gauge	Construction	Insulation
mm ²	AWG	n x Ø mm	mm
0.22	24	7 x 0.20	1.04
0.34	22	7 x 0.25	1.24
0.60	20	19x 0.20	1.65
0.93	18	19 x 0.25	1.90

Example of ordering : SMA-ZH 7 x 0.34 ; SMBL-ZH 19 x 0.93

SMA-ZH/SMBL-ZH colour coding

Core. n°	Plain colour	Core n°	Plain colour/ Ring colour	Core. n°	Plain colour	Core n°	Plain colour/ Ring colour
1	White	11	White/Blue	21	Blue/Brown	31	Yellow/Green
2	Light Blue	12	White/Yellow	22	Blue/Black	32	Yellow/Grey
3	Yellow	13	White/Brown	23	Blue/Red	33	Yellow/Orange
4	Brown	14	White/Black	24	Blue/Green	34	Yellow/Purple
5	Black	15	White/Red	25	Blue/Grey	35	Brown/Black
6	Red	16	White/Green	26	Blue/Orange	36	Brown/Red
7	Green	17	White/Grey	27	Blue/Purple	37	Brown/Green
8	Grey	18	White/Orange	28	Yellow/Brown		
9	Orange	19	White/Purple	29	Yellow/Black		
10	Purple	20	White/Yellow	30	Yellow/Red		

G250-ZH

**Halogen free flexible pairs
Screened with overall braid**

Applications

Interconnection cables for intercoms. Flexible links for low current and electronics use or where screening is required between circuits, mainly for data transmission.

Halogen free, they are intended to be used in places where the protection of the people and equipment is vital.

We recommend to use them for cabinet wiring in public areas such as railway or subway stations but also in industrial areas, etc...

250 Volts

Construction

1- CORE

stranded, 7x0.20 mm tinned copper

2- INSULATION

Halogen free

3- LAY UP

under polyester tape

4- SCREEN

tinned copper braid

K > 55%

5- OUTER JACKET

Halogen free

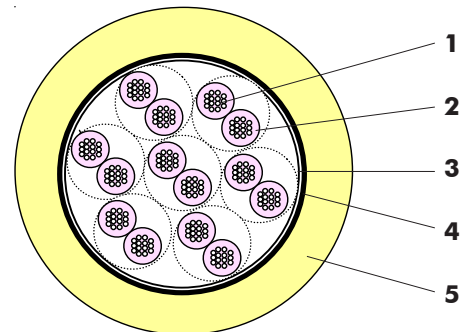





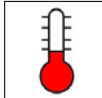

Colour coding

Colour coding of the cores by plain colours and rings.

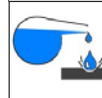
Standards

NEXANS specification
These cables are UL 21283 qualified (80°C). They can be manufactured with an UL marking on request.

							
- 40°C to +80°C	Flame retardant (NF C 32-070/C2, IEC 60332-1/2)	Low smoke emission and low opacity (IEC 61034)	Non corrosive and non toxic (IEC 60754-2)	Flexible	Screened versions	Halogen free (IEC 60754-1)	RoHS

■ G250-ZH - Halogen free flexible pairs, screened with overall braid

Nb of pairs	Nexans Reference	CORE			BRAID		Overall diameter		Average weight
		Gauge AWG	Cross section mm ²	Construction n x Ø mm	Ø strand	Ø mm	Ø mm	Tolerance mm	Kg/Km
2	G250-ZH-2/2	24	0.22	7 x 0.20	0.12	3.55	5.1	± 0.30	36
3	G250-ZH-3/2	24	0.22	7 x 0.20	0.12	4.00	5.50	± 0.40	44
5*	G250-ZH-5/2	24	0.22	7 x 0.20	0.12	5.1	6.6	± 0.40	64
7	G250-ZH-7/2	24	0.22	7 x 0.20	0.12	5.55	7.1	± 0.40	82
10	G250-ZH-10/2	24	0.22	7 x 0.20	0.13	6.60	8.1	± 0.40	106
12	G250-ZH-12/2	24	0.22	7 x 0.20	0.13	7.10	8.7	± 0.40	123
15	G250-ZH-15/2	24	0.22	7 x 0.20	0.13	7.95	9.6	± 0.50	147
21	G250-ZH-21/2	24	0.22	7 x 0.20	0.15	9.30	11.3	± 0.50	208
25	G250-ZH-25/2	24	0.22	7 x 0.20	0.15	10.40	12.7	± 0.40	242
30	G250-ZH-30/2	24	0.22	7 x 0.20	0.15	11.90	14.70	± 0.60	300

* PVC filler

■ Electrical characteristics

Attenuation	Value	Unit
Maximum loop resistance at 20°C	≤ 200	Ω/km
Insulation resistance at 20°C at 200 volts dc	≥ 500	MΩ.km

■ G250-SH colour coding

PAIR #	1	2	3	4	5	6	7	8	9	10
WIRE 1	Blue	Yellow	Brown	Black	Green	White/Blue	Yellow/Blue	Brown/Blue	Blue/Black	Green/Blue
WIRE 2	White	White	White	White	White	White	White	White	White	White

PAIR #	11	12	13	14	15	16	17	18	19	20
WIRE 1	White/ Yellow	Yellow/ Brown	Yellow/ Black	Yellow/ Green	White/ Brown	Brown/ Black	Brown/ Green	White/ Black	Green/ Black	White/ Green
WIRE 2	White	White	White	White	White	White	White	White	White	White

PAIR #	21	22	23	24	25	26	27	28	29	30
WIRE 1	Blue	Yellow	Brown	Black	Green	White/Blue	Yellow/Blue	Brown/Blue	Blue/Black	Green/Blue
WIRE 2	White/Red	White/Red	White/Red	White/Red	White/Red	White/Red	White/Red	White/Red	White/Red	White/Red

White/Blue = White ring Blue

105°C

UL 1015 Hook-up wires

Applications

Those wires are mainly designed for internal wiring in electrical and electronic equipments.

They are well suited to work under stringent conditions.

They are both UL and RoHS qualified. They can be used in all equipments in Europe or world wide.

500 volts

Construction

1 - AME

stranded tinned copper wires

2 - ISOLATION

Polyvinyl chloride (PVC-UL)



Standards

UL AWM Style 1015

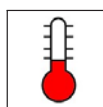

-20 °C to +105°C



Flame retardant
UL VW-1



Flexible



RoHS

■ UL 1015 - Hook-up wires

Nexans Reference	CONDUCTOR			Overall diameter mm
	Gauge AWG	Cross section mm ²	Construction n x Ø mm	
UL 1015 600V 105 °C	24	0.25	19 x 0.13	2.30 ± 0.10
UL 1015 600V 105 °C	22	0.38	19 x 0.16	2.45 ± 0.10
UL 1015 600V 105 °C	18	0.93	19 x 0.25	2.95 ± 0.10
UL 1015 600V 105 °C	16	1.3	19 x 0.30	3.10 ± 0.10
UL 1015 600V 105 °C	12	3.3	65 x 0.255	4.00 ± 0.12

KY/EPDX Unscreened hook-up wires

Applications

These wires are mainly designed for internal wiring in electronic equipment.

250 and 750 Volts

Construction

1- CONDUCTOR

Stranded annealed tinned copper wires

2- INSULATION

High temperature polyvinyl chloride (PVC)



Standards

NF C 93-521

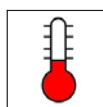

- 40°C to +105°C



Fire retardant
(NF C 32-070/C1)



Flexible



RoHS

KY/EPDX - Unscreened hook-up wires - 250 volts

Reference NFC 93 521	Nexans Reference	CONDUCTOR			Overall diameter		Average weight Kg/Km
		Gauge AWG	Cross section mm ²	Construction n x Ø mm	Mini mm	Maxi mm	
KY 30-01	EPDX 6x0	30	0.055	7 x 0.10	0.70	0.80	1.0
KY 30-02	EPDX 5x0	28	0.079	7 x 0.12	0.76	0.86	1.3
KY 30-03	EPDX 4x0	26	0.12	7 x 0.15	0.80	1.00	1.7
KY 30-04	EPDX 000	24	0.22	7 x 0.20	1.00	1.20	2.8
KY 30-05	EPDX 00	22	0.34	7 x 0.25	1.20	1.45	4.3
KY 30-06	EPDX 26	20	0.60	19 x 0.20	1.60	1.90	7.4
KY 30-07	EPDX 27	18	0.93	19 x 0.25	1.85	2.15	11.0
KY 30-08	EPDX 28	16	1.34	19 x 0.30	2.20	2.50	15.5
-	EPDX 29	14	1.91	27 x 0.30	2.55	2.85	21.5
-	EPDX 100	12	3.18	45 x 0.30	3.20	3.60	35.5
-	EPDX 140	10	5.16	73 x 0.30	3.90	4.30	55.5

KY/EPDX - Unscreened hook-up wires - 750 volts

Reference NFC 93 521	Nexans Reference	CONDUCTOR			Overall diameter		Average weight Kg/Km
		Gauge AWG	Cross section mm ²	Construction n x Ø mm	Mini mm	Maxi mm	
KY 33 A-01	EPDX 6	24	0.22	7 x 0.20	1.60	1.80	4.6
KY 33 A-02	EPDX 7	22	0.38	12 x 0.20	2.00	2.30	7.3
KY 33 A-03	EPDX 16	20	0.60	19 x 0.20	2.20	2.50	9.8
KY 33 A-04	EPDX 17	18	1.00	32 x 0.20	2.50	2.80	14.4
KY 33 A-05	EPDX 8	16	1.34	19 x 0.30	2.70	3.00	18.0
KY 33 A-06	EPDX 9	14	1.91	27 x 0.30	3.00	3.40	24.3
KY 33 A-07	EPDX 10	12	3.18	45 x 0.30	3.80	4.20	39.7
KY 33 A-08	EPDX 14	10	5.15	73 x 0.30	4.40	4.80	59.9
-	EPDX 18	9	7.40	105 x 0.30	5.00	5.40	81.8
KY 33 A-09	EPDX 15	8	10.20	144 x 0.30	5.80	6.20	112.0
KY 33 A-010	EPDX 19	4	24.70	126 x 0.50	9.60	10.20	274.0

KY/EPDX

Screened hook-up wires, screened and jacketed hook-up wires

Applications

These wires are mainly designed for internal wiring in electronic equipment.

250 and 750 Volts

Construction

1- CONDUCTOR

stranded annealed tinned copper wires

2- INSULATION

high temperature polyvinyl chloride (PVC)

3- SCREEN

tinned copper braid

4- OUTER JACKET

polyvinyl chloride (PVC), or superpolyamide (P)

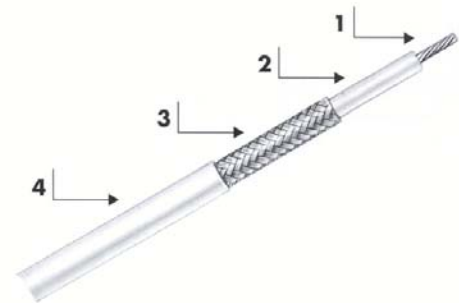

Standards

NF C 93-521

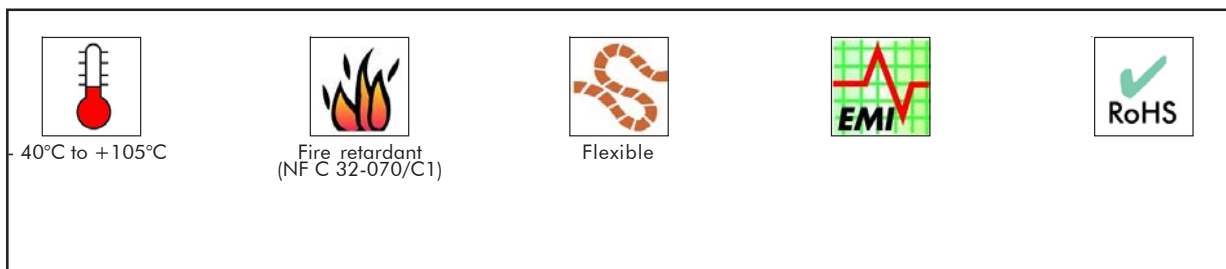

KY/EPDX - Screened hook-up wires

Nb of Cond.	Reference NFC93-521	Nexans Reference	BASE CORE				Braid		Overall diameter		Average weight
			CONDUCTOR			Nominal Ø core mm	Ø strands mm	kr %	mini mm	maxi mm	Kg/Km
			Gauge AWG	Cross section mm ²	Construction n x Ø mm						

TYPE KY - 250 VOLTS - STRANDED CONDUCTOR

1	KY 45-01	EPDX 4x0 BL	26	0.12	7 x 0.15	0.90	0.10	55	1.2	1.7	4.8
1	KY 45-02	EPDX 000 BL	24	0.22	7 x 0.20	1.10	0.10	55	1.4	1.9	6.6
1	KY 45-03	EPDX 00 BL	22	0.34	7 x 0.25	1.30	0.10	60	1.6	2.2	8.5

TYPE KY - 750 VOLTS - STRANDED CONDUCTOR

1	KY 37 A-01	EPDX 6 BL	24	0.22	7 x 0.20	1.70	0.10	60	1.9	2.4	10.2
1	KY 37 A-02	EPDX 7 BL	22	0.38	12 x 0.20	2.15	0.12	65	2.4	3.1	16.5
1	KY 37 A-03	EPDX 16 BL	20	0.60	19 x 0.20	2.35	0.12	65	2.6	3.3	19.9
1	KY 37 A-04	EPDX 17 BL	18	1.00	32 x 0.20	2.65	0.12	65	2.9	3.6	25.5
1	KY 37 A-05	EPDX 8 B L	16	1.34	19 x 0.30	2.85	0.12	65	3.1	3.8	30.2
1	KY 37 A-06	EPDX 9 B L	14	1.91	27 x 0.30	3.20	0.12	70	3.4	4.2	39.0

KY/EPDX - screened and jacketed hook-up wires

Nb of Cond.	Reference NFC93-521	Nexans Reference	BASE CORE				Braid		Outer jacket nature	Overall diameter		Average weight
			CONDUCTOR			Nominal Ø core mm	Ø strands mm	kr %		mini mm	maxi mm	Kg/Km
			Gauge AWG	Cross section mm ²	Construction n x Ø mm							

TYPE KY - 250 VOLTS - STRANDED CONDUCTOR

1	KY46-01	EPDX4x0 BL.P	26	0.12	7 x 0.15	0.90	0.10	55	P	1.4	2.1	5.2
1	KY46-02	EPDX3x0 BLP	24	0.22	7 x 0.20	1.10	0.10	55	P	1.6	2.3	7.4
1	KY46-03	EPDX 00 BLP	22	0.34	7 x 0.25	1.30	0.10	60	P	1.8	2.6	9.5

TYPE KY - 750 VOLTS - STRANDED CONDUCTOR

1	KY 41 A-01	EPDX6 BLI	24	0.22	7 x 0.20	1.7	0.10	60	PVC	3.1	3.8	18.1
1	KY 44 A-01	EPDX 6 BLP	24	0.22	7 x 0.20	1.7	0.10	60	P	2.1	2.8	11.2
1	KY 41 A-02	EPDX 7 BLI	22	0.38	12 x 0.20	2.15	0.12	65	PVC	3.6	4.5	26.2
1	KY 44 A-02	EPDX 7 BLP	22	0.38	12 x 0.20	2.15	0.12	65	P	2.6	3.5	17.7
1	KY 41 A-03	EPDX 16 BLI	20	0.60	19 x 0.20	2.35	0.12	65	PVC	3.8	4.7	30.0
1	KY 44 A-03	EPDX 16 BLP	20	0.60	19 x 0.20	2.35	0.12	65	P	2.8	3.7	21.2
1	KY 41 A-04	EPDX17BLI	18	1.0	32 x 0.20	2.65	0.12	65	PVC	4.1	5.0	36.6
1	KY 44 A-04	EPDX17BLP	18	1.0	32 x 0.20	2.65	0.12	65	P	3.1	4.0	26.9
1	KY 41 A-05	EPDX8 BLI	16	1.34	19 x 0.30	2.85	0.12	65	PVC	4.3	5.2	41.9
1	KY 44 A-05	EPDX8 BLP	16	1.34	19 x 0.30	2.85	0.12	65	P	3.3	4.2	31.7
1	KY 41 A-06	EPDX 9 BLI	14	1.91	27 x 0.30	3.20	0.12	70	PVC	4.6	5.5	51.4
1	KY 44 A-06	EPDX 9BLP	14	1.91	27 x 0.30	3.20	0.12	70	P	3.6	4.6	40.6

Reference.. BLI: PVC outer jacket giving a good mechanical protection and electrical insulation

Reference.. BLP: Superpolyamide outer jacket providing only a mechanical protection

KY/EPDX

Screened pairs, screened and jacketed pairs

Applications

These wires are mainly designed for internal wiring in electronic equipment.

250 and 750 Volts

Construction

1- CONDUCTOR

stranded annealed tinned copper wires

2- INSULATION

high temperature polyvinyl chloride (PVC)

3- SCREEN

tinned copper braid



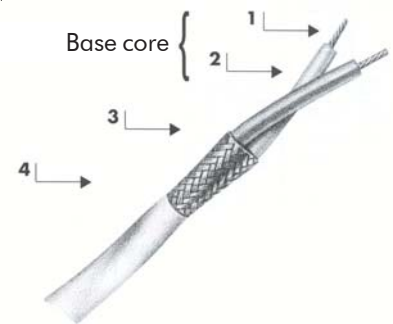

4- OUTER JACKET

polyvinyl chloride (PVC), or superpolyamide (P)



Standards

NF C 93-521

 <p>40°C to +105°C</p>	 <p>Fire retardant (NF C 32-070/C1)</p>	 <p>Flexible</p>	 <p>EMI</p>	 <p>RoHS</p>
---	--	---	--	---

KY/EPDX - Screened pairs

Nb of cores	Reference NFC93-521	Nexans Reference	BASE CORE				Nominal Ø core mm	Ø Over lay up of cores mm	Braid		Outer jacket nature	Overall diameter		Average weight Kg/Km
			CONDUCTOR			Ø strands mm			kr %	mini mm		maxi mm		
			Gauge AWG	Cross section mm ²	Construction n x Ø mm									

TYPE KY - 250 VOLTS - STRANDED CONDUCTOR

2	KY 93-01	DX 4x0 BL	26	0.12	7 x 0.15	0.90	1.80	0.10	60	-	1.9	2.7	10.8
2	KY 93-02	DX 000BL	24	0.22	7 x 0.20	1.10	2.20	0.10	60	-	2.3	3.1	15.0
2	KY 93-03	DX 00 BL	22	0.34	7 x 0.25	1.30	2.60	0.12	65	-	2.8	3.8	18.0

TYPE KY - 750 VOLTS - STRANDED CONDUCTOR

2	KY 70 A-01	DX 7 BL	22	0.38	12 x 0.20	2.15	4.3	0.12	70	-	4.5	5.4	31.3
2	KY 70 A-02	DX 8 BL	16	1.34	19 x 0.30	2.85	5.7	0.12	75	-	5.9	6.8	60.0

KY/EPDX - Screened and jacketed pairs

Nb of cores	Reference NFC93-521	Nexans Reference	BASE CORE				Nominal Ø core mm	Ø Over lay up of cores mm	Braid		Outer jacket nature	Overall diameter		Average weight Kg/Km
			CONDUCTOR			Ø strands mm			kr %	mini mm		maxi mm		
			Gauge AWG	Cross section mm ²	Construction n x Ø mm									

TYPE KY - 250 VOLTS - STRANDED CONDUCTOR

2	KY 91-01	DX 4x0 BL.P	26	0.12	7 x 0.15	0.90	1.80	0.10	60	P	2.1	3.1	12.1
2	KY 91-02	DX 000 BL.P	24	0.22	7 x 0.20	1.10	2.20	0.10	60	P	2.5	3.5	16.0
2	-	DKY30-04 BLBV	24	0.22	7 x 0.20	1.10	2.20	0.10	60	PVC	2.6	3.7	18.2
2	KY 91-03	DX00 BLP	22	0.34	7 x 0.25	1.30	2.60	0.12	65	P	3.0	4.2	19.4
2	-	DKY30-05 BLBV	22	0.34	7 x 0.25	1.30	2.60	0.12	65	PVC	3.0	4.2	22.2

TYPE KY - 750 VOLTS - STRANDED CONDUCTOR

2	KY 83 A-01	DX 6 BLP	24	0.22	7 x 0.20	1.70	3.40	0.12	65	P	3.9	4.8	23.5
2	KY 83 A-02	DX 7 BLP	22	0.38	12 x 0.20	2.15	4.30	0.12	70	P	4.7	5.8	34.0
2	-	DKY33A-02 BLBV	22	0.38	12 x 0.20	2.15	4.30	0.12	70	PVC	4.7	5.8	40.6
2	-	DKY33A-03 BLBV	20	0.60	19 x 0.20	2.35	4.70	0.12	65	PVC	5.1	6.2	42.7
2	-	DKY33A-04 BLBV	18	1.00	32 x 0.20	2.65	5.30	0.12	65	PVC	5.8	6.9	58.3
2	KY 83 A-03	DX 8 BL.P	16	1.34	19 x 0.30	2.85	5.70	0.12	75	P	6.1	7.2	63.6
2	-	DKY33A-05 BLBV	16	1.34	19 x 0.30	2.85	5.70	0.12	75	PVC	6.1	7.2	69.9

Reference.. BLP: superpolyamide outer jacket providing only a mechanical protection.

Reference.. BLBV: PVC outer jacket providing a good mechanical protection and electrical insulation.

KY/EPDX

Screened triples, screened and jacketed triples

Applications

These wires are mainly designed for internal wiring in electronic equipment.

250 and 750 Volts

Construction

1- CONDUCTOR

stranded annealed tinned copper wires

2- INSULATION

high temperature polyvinyl chloride (PVC)

3- SCREEN

tinned copper braid



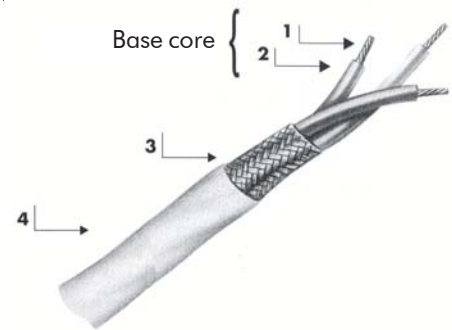

4- OUTER JACKET

polyvinyl chloride (PVC) or superpolyamide (P)



Standards

NF C 93-521

 <p>40°C to +105°C</p>	 <p>Fire retardant (NF C 32-070/C1)</p>	 <p>Flexible</p>	 <p>EMI</p>	 <p>RoHS</p>
---	--	---	--	---

KY/EPDX - Screened triples

Nb of cores	Reference NFC93-521	Nexans Reference	BASE CORE				Nominal Ø core mm	Ø Over lay up of cores mm	Braid		Outer jacket nature	Overall diameter		Average weight Kg/Km
			CONDUCTOR			Ø strands mm			kr %	mini mm		maxi mm		
			Gauge AWG	Cross section mm ²	Construction n x Ø mm									

TYPE KY- 250 VOLTS - STRANDED CONDUCTOR

3	KY 94-01	TX 4x0 BL	26	0.12	7x 0.15	0.9	2	0.1	60	-	2	2.8	13.1
3	KY 94-02	TX 000BL	24	0.22	7 x 0.20	1.1	2.4	0.1	60	-	2.4	3.2	18.8
3	KY 94-03	TX 00 BL	22	0.34	7 x 0.25	1.3	2.8	0.12	65	-	3	4	22.2

TYPE KY- 750 VOLTS - STRANDED CONDUCTOR

3	KY 72 A01	TX 7 BL	22	0.38	12 x 0.20	2.15	4.6	0.12	75	-	4.8	5.8	43.7
---	------------------	---------	----	------	-----------	------	-----	------	----	---	-----	-----	------

KY/EPDX - Screened and jacketed triples

Nb of cores	Reference NFC93-521	Nexans Reference	BASE CORE				Nominal Ø core mm	Ø Over lay up of cores mm	Braid		Outer jacket nature	Overall diameter		Average weight Kg/Km
			CONDUCTOR			Ø strands mm			kr %	mini mm		maxi mm		
			Gauge AWG	Cross section mm ²	Construction n x Ø mm									

TYPE KY- 250 VOLTS - STRANDED CONDUCTOR

3	KY 92-01	TX 4x0 BLP	26	0.12	7x 0.15	0.9	2	0.1	60	P	2.2	3.3	14.4
3	KY 92-02	TX 000 BLP	24	0.22	7 x 0.20	1.1	2.4	0.1	60	P	2.6	3.7	20.5
3	KY 92-03	TX00 BLP TKY30-05	22	0.34	7 x 0.25	1.3	2.8	0.12	65	P	3.2	4.4	24
3	-	BLBV	22	0.34	7 x 0.25	1.3	2.8	0.12	65	P	3.2	4.4	31.1

TYPE KY- 750 VOLTS - STRANDED CONDUCTOR

3	KY 84 A-01	TX 6 BLP	24	0.22	7 x 0.20	1.7	3.7	0.12	70	P	4.1	5.1	31.7
3	KY 84 A-02	TX 7 BLP TKY33A-03	22	0.34	7 x 0.25	2.15	4.6	0.12	75	P	5	6.2	46.5
3	-	BLBV TKY33A-04	20	0.6	19 x 0.20	2.35	5	0.12	65	P	5.4	6.6	60.7
3	-	BLBV	18	1	32 x 0.20	2.65	5.7	0.12	65	P	6.1	7.3	83.5
3	KY 84 A-03	TX 8 BLP	16	1.34	19 x 0.30	2.85	6.2	0.15	75	P	6.5	7.7	94.3

Reference:... BLP: superpolyamide outer jacket providing only a mechanical protection.

Reference:... BLBV: PVC outer jacket providing a good mechanical protection and electrical insulation.

Applications

Flexible cables and lightweight range with PVC + super-polyamide insulation for use in low temperature areas. Good abrasion resistance. They withstand most chemical fluids except for concentrated nitric acid.

600 Volts RMS

Construction

1- CONDUCTOR

stranded tinned copper wires or stranded tinned copper alloy wires for the cross section area 0.21 mm²

2- INSULATION

polyvinyl chloride (PVC)

3- OUTER JACKET

superpolyamide (radial thickness: from 0.10 mm up to 0.15 mm)



Technical requirements and control conditions

Air 4524 specification of September 1965 - The 105/135°C cat.
NFL 52-120B - BNAé specification of December 1971 - Lightweight cables.

Colour coding

To AIR 0107A specification of October 1961.

Interchangeability

MIL-W-5086 B/7 U.S. specification (December 1970).
AICMA N° 5102 specification (December 1962).

Standards

To AIR 4524 and MIL.W 5086 B/7A specifications.

These cables are approved by the Air Ministry under letters:

N° 41762 STA/EQ/E2 (12-11-68)
for AWG22 up to AWG 8

N° 33587 STA/EQ/E2 (30-3-72)
for AWG24

Registered at B.N.Aé:
N° 6412 411 A

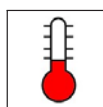

- 40°C to +105°C



Fire retardant
(NF C 32-070/C1)



Flexible



RoHS

1604 - Unscreened hook-up wires

Nexans Reference			CONDUCTOR			CORE		DC resist. at 20°C (maxi.) Ω / km	Current rating A	Colour of cores
Type	Cross section	AWG	Construction n x \emptyset mm	Nominal \emptyset mm	Tensile strength daN.	Overall diameter mm	Average weight Kg/Km			
1604	0.21	24	19 x 0.12 T.P.C. All.	0.60	7	1.38 \pm 0.07	3.4	105.0	4	Light Blue
1604	0.38	22	12 x 0.20 T.P.C.	0.80	8	1.50 \pm 0.07	5.1	50.9	7	White
1604	0.60	20	19 x 0.20 T.P.C.	1.00	16	1.70 \pm 0.07	7.5	32.2	11	Light Blue
1604	0.93	18	19 x 0.25 T.P.C.	1.20	20	2.0 \pm 0.07	11.0	20.6	16	White
1604	1.34	16	19 x 0.30 T.P.C.	1.50	20	2.30 \pm 0.10	14.0	14.3	22	Light Blue
1604	1.91	14	27 x 0.30 T.P.C.	1.80	20	2.70 \pm 0.10	21.6	10.1	32	White
1604	3.18	12	45 x 0.30 T.P.C.	2.30	20	3.50 \pm 0.10	36.1	6.0	41	White
1604	5.15	10	73 x 0.30 T.P.C.	3.00	20	4.20 + 0.10/- 0.20	55.1	3.7	55	White
1604	8.98	8	127 x 0.30 T.P.C.	3.80	20	5.50 + 0.10/- 0.20	90.2	2.1	75	White

The shown current rating is valid for singles wires in air.

604

Screened and jacketed hook-up wires and multicore cables

Applications

Flexible cables and lightweight range with PVC + superpolyamide insulation for use in low temperature areas
 Good abrasion resistance.
 They withstand most chemical fluids except for concentrated nitric acid.

600 Volts RMS

Construction

BASE CORE 1604

1- CONSTRUCTION

stranded tinned copper wires or stranded tinned copper alloy wires for cross section 0.21 mm

2- INSULATION

polyvinyl chloride (PVC)

3- OUTER JACKET

superpolyamide (radial thickness: from 0.10 mm up to 0,15 mm)

604

4- LAY UP

1 or several 1604 cores

5- SCREEN

tinned copper braid (Kr ≥ 62%)

6- OUTER JACKET

superpolyamide (radial thickness: about 0.20mm)



Technical requirements and control conditions

Screen: to MIL.C. 7078C (August 1971) U.S. specification

Colour coding

To Air 0107 A (October 1961) and note N° 348/SIB distributed under n° 5927/STT/SIB (3 May 1961).

Standards





To AIR 4524 & MIL-W 5086B/7A specifications.

These cables are approved by the Air Ministry under letters:

N° 33587 STA/EQ/E2 (30-3-72) for AWG 24

N° 41762 STA/EQ/E2 (12-11-68) for AWG 22 up to AWG 8

Registered at B.N.Aé : N° 6412 411 A

 <p>40°C to +105°C</p>	 <p>Fire retardant (NFC 32-070/C1)</p>	 <p>Flexible</p>		
---	---	---	---	---

604 - Screened and jacketed hook-up wires and multicore cables

Nb of cores	Nexans Reference				BASE CORE : 1604			SERIE 604		
					Construction n x Ø mm	Overall diameter nominal mm	Colour coding of cores	Colour of outer jacket	Overall diameter (maxi.) mm	Average weight Kg/Km
1	604	1	0.21	G 24	19 x 0.12 T.P.C All	1.38	Light blue	Light blue	2.25	9.0
1	604	1	0.38	G 22	12 x 0.20 T.P.C.	1.50	White	White	2.55	11.7
1	604	1	0.60	G 20	19 x 0.20 T.P.C.	1.70	Light blue	Light blue	2.75	14.7
1	604	1	0.93	G 18	19 x 0.25 T.P.C.	2.00	White	White	3.05	19.2
1	604	1	1.34	G 16	19 x 0.30 T.P.C.	2.30	Light blue	Light blue	3.35	25.0
1	604	1	1.91	G 14	27 x 0.30 T.P.C.	2.70	White	White	3.75	31.8
1	604	1	3.18	G 12	45 x 0.30 T.P.C.	3.50	White	White	4.73	51.2
2	604	2	0.21	G 24	19 x 0.12 T.P.C All	1.38	Light blue + Blue	Light blue	3.70	5.6
2	604	2	0.38	G 22	12 x 0.20 T.P.C.	1.50	White + Blue	White	4.10	20.6
2	604	2	0.60	G 20	19 x 0.20 T.P.C.	1.70	Light blue + Blue	Light blue	4.50	27.9
2	604	2	0.93	G 18	19 x 0.25 T.P.C.	2.00	White + blue	White	5.10	37.5
2	604	2	1.34	G 16	19 x 0.30 T.P.C.	2.30	Light blue + Blue	Light blue	5.70	49.2
2	604	2	1.91	G 14	27 x 0.30 T.P.C.	2.70	White + Blue	White	6.60	62.9
2	604	2	3.18	G 12	45 x 0.30 T.P.C.	3.50	White + Blue	White	8.56	102.9
3	604	3	0.21	G 24	19 x 0.12 T.P.C All	1.38	Light blue + Blue + Yellow	Light blue	3.95	22.6
3	604	3	0.38	G 22	12 x 0.20 T.P.C.	1.50	White + Blue + Yellow	White	4.35	29.8
3	604	3	0.60	G 20	19 x 0.20 T.P.C.	1.70	Light blue + Blue + Yellow	Light blue	4.80	38.6
3	604	3	0.93	G 18	19 x 0.25 T.P.C.	2.00	White + Blue + Yellow	White	5.45	51.7
3	604	3	1.34	G 16	19 x 0.30 T.P.C.	2.30	Light blue + Blue + Yellow	Light blue	6.10	68.6
3	604	3	1.91	G 14	27 x 0.30 T.P.C.	2.70	White + Blue + Yellow	White	7.00	88.5
3	604	3	3.18	G 12	45 x 0.30 T.P.C.	3.50	White + Blue + Yellow	White	9.11	145.6
4	604	4	0.21	G 24	19 x 0.12 T.P.C All	1.38	Light Blue + Blue + Yellow + Green	Light blue	4.40	28.4
4	604	4	0.38	G 22	12 x 0.20 T.P.C.	1.50	White + Blue+ Yellow + Green	White	4.90	37.8
4	604	4	0.60	G 20	19 x 0.20 T.P.C.	1.70	Light blue + Blue + Yellow + Green	Light blue	5.40	49.1
4	604	4	0.93	G 18	19 x 0.25 T.P.C.	2.00	White + Blue + Yellow + Green	White	6.10	66.4
4	604	4	1.34	G 16	19 x 0.30 T.P.C.	2.30	Light blue + Blue + Yellow + Green	Light blue	7.00	88.6
4	604	4	1.91	G 14	27 x 0.30 T.P.C.	2.70	White + Blue + Yellow + Green	White	7.90	121.0
4	604	4	3.18	G 12	45 x 0.30 T.P.C.	3.50	White + Blue + Yellow + Green	White	10.06	186.9

1625 A

Unscreened hook-up wires

Applications

Flexible cables for use in low temperature areas up to 135°C at peak.
 Excellent resistance to abrasion and short-circuits.
 They withstand most chemical fluids.
 They are non-flammable.

600 Volts RMS

Construction

1- CONDUCTOR

stranded tinned copper wires or stranded tinned copper alloy wires for cross section 0.21 mm² (good mechanical resistance)

2- INSULATION

polyvinyl chloride (PVC)

3- Braid of fibre glass

with non-flammable varnish

4- OUTER SHEATH

a) from 0.21 to 3.18 mm² :

superpolyamide braid (high resistance to abrasion)

b) from 3.18 mm² :

superpolyamide braid with a special varnish

Cross sections from 0.21 mm² to 3.18 mm²



Cross sections from 5.15 mm²

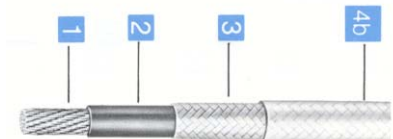

Technical requirements and control conditions

Air 4524 specification of September 1965 - The 105/135°C cat.

Colour coding

To AIR 0107A specification of October 1961.

Standards

To AIR 4524

These cables are approved by the Air Ministry under letters:

N°34438 STA/EQ.E2 (14-04-62)

N°40221 STA/EQ.E2 (05-10-64)

for cross sections >0.38 mm²

N°32660 STA/EQ/E2 (10-03-70)

for 0.21 mm² cross section

Registered at B.N.Aé :

N° 6411 401E

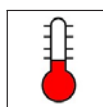

- 55°C to +105°C



AIR 4524



Flexible



RoHS

1625 A - Unscreened hook-up wires

Nexans Reference	US AWG	Conductor			Finished cable			
		Construction n x Ø mm	Overall diameter mm		DC resist. at 20°C Ω / km	Overall diameter mm		Average weight Kg/Km
			Nom.	Max.		Max.	Nom.	
1625 A 0.21 G.24	24	19 x 0.12	0.58	0.65	105	1.54	1.70	5.50
1625 A 0.38 G.22	22	12 x 0.20	0.77	0.85	50.9	1.84	2	6.80
1625 A 0.60 G.20	20	19 x 0.20	0.97	1.03	32.2	2.04	2.30	10.10
1625 A 0.93 G.18	18	19 x 0.25	1.22	1.28	20.6	2.29	2.50	14.00
1625 A 1.34 G.16	16	19 x 0.30	1.46	1.53	14.3	2.64	2.80	17.70
1625 A 1.91 G.14	14	27 x 0.30	1.75	1.87	10.1	2.94	3.30	27.20
1625 A 3.18 G.12	12	45 x 0.30	2.26	2.40	6	3.71	3.80	38.60
1625 A 5.15 G.10	10	73 x 0.30	2.87	3.10	3.6	4.28	5.00	65.40
1625 A 8.98 G.8	8	127 x 0.30	3.79	4.20	2.1	5.49	6.03	103.50
1625 A 13.40 G.6	6	27 x 7 x 0.30	5.15	5.60	1.48	7.03	7.60	163.00
1625 A 21.80 G.4	4	37 x 12 x 0.25	6.58	7.30	0.91	9.03	9.30	244.50
1625 A 34.50 G.2	2	37 x 19 x 0.25	8.28	8.80	0.57	10.90	11.00	370.00
1625 A 41.80 G.1	1	37 x 23 x 0.25	9.11	9.80	0.47	12.10	12.20	452.00
1625 A 52.70 G.0	0	37 x 29 x 0.25	10.23	10.80	0.373	13.60	13.70	592.00
1625 A 67.20 G.00	00	37 x 37 x 0.25	11.55	12.40	0.293	15.00	15.40	740.00
1625 A 84.80 G.000	000	48 x 36 x 0.25	12.98	13.80	0.232	16.60	16.90	918.00
1625 A 108 G.0000	0000	61 x 36 x 0.25	14.63	15.50	0.184	18.30	18.60	1160.00

FLAMEX SH20

Unscreened halogen free hook-up wires, screened and jacketed hook-up wires

Applications

Strictly halogen free, these wires combine the advantages of small size, lightweight, high chemical resistance, high mechanical properties. They are particularly recommended for applications where personal and material safety is required in case of fire.

Flamex SH20 - 600 Vac / 1000 Vcc

Construction

1- Conductor

Stranded tinned copper wires

2- Insulation

Thin wall halogen free, FLAMEX SH20

3- Screen

(screened versions)

Tinned copper braid with optional polyester tape

4- Outer sheath

(screened versions)

Halogen free FLAMEX

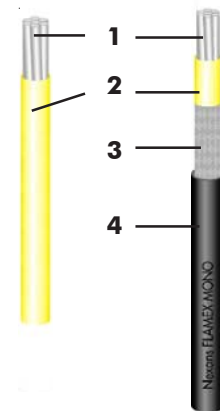

Colour coding

For NF F 63-808 cables :

0.60 (AWG20)	0.93 (AWG18)	1.34 (AWG16)	1.82 (AWG14)	2.61 (AWG14)	4.32 (AWG12)
Yellow	White	Green	Yellow	White	Green

For EN 50306 cables :







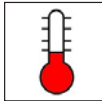
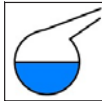

Insulation : white, numbered 1 to n

Colour coded wires on request

Sheath : black

Standards

NFF 63808, EN 50306.

							
- 40°C to +105°C	Good chemical resistance (acids, oils, ...) IRM 902, IRM 903	Flame and fire retardant (NF C 32-070/C1 & C2, IEC 60332-1/2/3, Cat.C and EN 50306-1)	Low smoke emission and low opacity (IEC 61034)	Non corrosive and non toxic (IEC 60754-2 and EN 50267)	Flexible	EMI	Halogen free (IEC 60754-1)
							

■ Flamex SH20 - Unscreened halogen free hook-up wires

Nexans Reference	CONDUCTOR				Insulation Ø		Average weight Kg / Km
	Gauge AWG	Cross section mm ²	Construction n x Ø mm	Maxi. Ø mm	mini. mm	maxi. mm	
FLAMEX 20 0.38	22	0.38	19x0.16 TC	0.85	1.15	1.35	4.70
FLAMEX 20 0.50	20	0.50	19x0.18 TC	0.95	1.15	1.45	6.00
FLAMEX 20 0.60	20	0.60	19x0.20 TC	1.05	1.30	1.50	6.60
FLAMEX 20 0.75	20	0.75	19x0.23 TC	1.15	1.35	1.65	8.50
FLAMEX 20 0.93	18	0.93	19x0.25 TC	1.30	1.55	1.75	10.00
FLAMEX 20 1.00	18	1.00	19x0.25 TC	1.30	1.45	1.80	10.50
FLAMEX 20 1.34	16	1.34	19x0.30 TC	1.55	1.80	2.00	14.00
FLAMEX 20 1.50	16	1.50	37x0.23 TC	1.65	1.95	2.30	16.00
FLAMEX 20 1.82	14	1.82	37x0.25 TC	1.82	2.10	2.40	19.20
FLAMEX 20 2.50	14	2.50	37x0.30 TC	2.15	2.50	2.85	26.50
FLAMEX 20 2.61	14	2.61	37x0.30 TC	2.28	2.50	2.80	27.80
FLAMEX 20 4.32	12	4.32	61x0.30 TC	2.90	3.00	3.30	44.20

TC = Tinned copper

■ Flamex SH20 - Screened and jacketed halogen free hook-up wires

Nexans Reference	CONDUCTOR				Insulation Ø		Overall Ø		Average weight Kg / Km
	Gauge AWG	Cross section mm ²	Construction n x Ø mm	Maxi. Ø mm	mini. mm	maxi. mm	mini. mm	maxi. mm	
FLAMEX 20 0.38 BLG	22	0.38	19x0.16 TC	0.85	1.15	1.35	2.05	2.55	11.50
FLAMEX 20 0.50 BLG	20	0.50	19x0.18 TC	0.95	1.15	1.45	2.30	2.80	14.00
FLAMEX 20 0.60 BLG	20	0.60	19x0.20 TC	1.05	1.30	1.50	2.30	2.80	15.00
FLAMEX 20 0.75 BLG	20	0.75	19x0.23 TC	1.15	1.35	1.65	2.50	3.00	17.00
FLAMEX 20 0.93 BLG	18	0.93	19x0.25 TC	1.30	1.55	1.75	2.50	3.00	19.00
FLAMEX 20 1.00 BLG	18	1.00	19x0.25 TC	1.30	1.45	1.80	2.70	3.20	20.00
FLAMEX 20 1.34 BLG	16	1.34	19x0.30 TC	1.55	1.80	2.00	2.70	3.20	24.00
FLAMEX 20 1.50 BLG	16	1.50	37x0.23 TC	1.65	1.95	2.30	3.10	3.60	28.00
FLAMEX 20 1.82 BLG	14	1.82	37x0.25 TC	1.82	2.10	2.40	3.25	3.75	32.00
FLAMEX 20 2.50 BLG	14	2.50	37x0.30 TC	2.15	2.50	2.85	3.60	4.40	43.00
FLAMEX 20 2.61 BLG	14	2.61	37x0.30 TC	2.28	2.50	2.80	3.60	4.20	43.00
FLAMEX 20 4.32 BLG	12	4.32	61x0.30 TC	2.90	3.00	3.30	4.15	4.75	63.00

TC = Tinned copper

FLAMEX SH20

Screened and jacketed,
halogen free multicore cables

Applications

Strictly halogen free, these wires combine the advantages of small size, lightweight, high chemical resistance, high mechanical properties. They are particularly recommended for applications where personal and material safety is required in case of fire.

Flamex SH20 - 600 Vac / 1000 Vcc

Construction

1- Conductor

Stranded tinned copper wires

2- Insulation

Thin wall halogen free,
FLAMEX SH20

3- Screen

Tinned copper braid with
optional polyester tape

4- Outer sheath

Halogen free FLAMEX

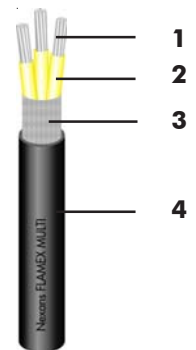

Colour coding

For NF F 63-808 cables :

0.60 (AWG20)	0.93 (AWG18)	1.34 (AWG16)	1.82 (AWG14)	2.61 (AWG14)	4.32 (AWG12)
Yellow	White	Green	Yellow	White	Green

For EN 50306 cables :







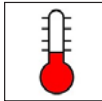
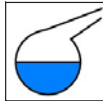

Insulation : white, numbered 1 to n

Colour coded wires on request

Sheath : black

Standards

NFF 63808, EN 50306.

							
- 40°C to +105°C	Good chemical resistance (acids, oils, ...) IRM 902, IRM 903	Flame and fire retardant (NF C 32-070/C1 & C2, IEC 60332-1/2/3, Cat.C and EN 50306-1)	Low smoke emission and low opacity (IEC 61034)	Non corrosive and non toxic (IEC 60754-2 and EN 50267)	Flexible	EMI	Halogen free (IEC 60754-1)
							

Flamex SH20 - Screened and jacketed, halogen free multicore cable

Nb of cond.	Nexans Reference	CONDUCTOR				Insulation Ø		Overall Ø		Average weight Kg / Km
		Gauge AWG	Cross section mm ²	Construction n x Ø mm	Maxi. Ø mm	mini. mm	maxi. mm	mini. mm	maxi. mm	
2	FLAMEX 20 2x 0.38 BLG	22	0.38	19x0.16 TC	0.85	1.15	1.35	3.20	4.00	20.00
2	FLAMEX 20 2x 0.50 BLG	20	0.50	19x0.18 TC	0.95	1.15	1.45	3.50	4.30	25.00
2	FLAMEX 20 2x 0.60 BLG	20	0.60	19x0.20 TC	1.05	1.30	1.50	3.70	4.50	30.00
2	FLAMEX 20 2x 0.75 BLG	20	0.75	19x0.23 TC	1.15	1.35	1.65	3.90	4.70	31.00
2	FLAMEX 20 2x 0.93 BLG	18	0.93	19x0.25 TC	1.30	1.55	1.75	4.25	5.05	39.00
2	FLAMEX 20 2x 1.00 BLG	18	1.00	19x0.25 TC	1.30	1.45	1.80	4.20	5.20	37.00
2	FLAMEX 20 2x 1.34 BLG	16	1.34	19x0.30 TC	1.55	1.80	2.00	4.80	5.60	52.00
2	FLAMEX 20 2x 1.50 BLG	16	1.50	37x0.23 TC	1.65	1.95	2.30	5.10	6.10	55.00
2	FLAMEX 20 2x 1.82 BLG	14	1.82	37x0.25 TC	1.82	2.10	2.40	5.55	6.35	67.00
2	FLAMEX 20 2x 2.50 BLG	14	2.50	37x0.30 TC	2.15	2.50	2.85	6.40	7.40	87.00
2	FLAMEX 20 2x 2.61 BLG	14	2.61	37x0.30 TC	2.28	2.50	2.80	6.35	7.15	87.00
2	FLAMEX 20 2x 4.32 BLG	12	4.32	61x0.30 TC	2.90	3.00	3.30	7.50	8.30	128.00
3	FLAMEX 20 3x 0.38 BLG	22	0.38	19x0.16 TC	0.85	1.15	1.35	3.55	4.35	30.00
3	FLAMEX 20 3x 0.50 BLG	20	0.50	19x0.18 TC	0.95	1.15	1.45	3.70	4.50	33.00
3	FLAMEX 20 3x 0.60 BLG	20	0.60	19x0.20 TC	1.05	1.30	1.50	4.00	4.80	39.00
3	FLAMEX 20 3x 0.75 BLG	20	0.75	19x0.23 TC	1.15	1.35	1.65	4.00	5.00	43.00
3	FLAMEX 20 3x 0.93 BLG	18	0.93	19x0.25 TC	1.30	1.55	1.75	4.50	5.30	52.00
3	FLAMEX 20 3x 1.00 BLG	18	1.00	19x0.25 TC	1.30	1.45	1.80	4.50	5.50	52.00
3	FLAMEX 20 3x 1.34 BLG	16	1.34	19x0.30 TC	1.55	1.80	2.00	5.10	5.90	66.00
3	FLAMEX 20 3x 1.50 BLG	16	1.50	37x0.23 TC	1.65	1.95	2.30	5.40	6.40	75.00
3	FLAMEX 20 3x 1.82 BLG	14	1.82	37x0.25 TC	1.82	2.10	2.40	5.80	6.60	84.00
3	FLAMEX 20 3x 2.50 BLG	14	2.50	37x0.30 TC	2.15	2.50	2.85	6.80	7.80	124.00
3	FLAMEX 20 3x 2.61 BLG	14	2.61	37x0.30 TC	2.28	2.50	2.80	6.80	7.60	117.00
3	FLAMEX 20 3x 4.32 BLG	12	4.32	61x0.30 TC	2.90	3.00	3.30	8.10	8.90	182.00
4	FLAMEX 20 4x 0.38 BLG	22	0.38	19x0.16 TC	0.85	1.15	1.35	4.05	4.85	39.00
4	FLAMEX 20 4x 0.50 BLG	20	0.50	19x0.18 TC	0.95	1.15	1.45	4.00	5.00	43.00
4	FLAMEX 20 4x 0.60 BLG	20	0.60	19x0.20 TC	1.05	1.30	1.50	4.50	5.30	51.00
4	FLAMEX 20 4x 0.75 BLG	20	0.75	19x0.23 TC	1.15	1.35	1.65	4.50	5.50	56.00
4	FLAMEX 20 4x 0.93 BLG	18	0.93	19x0.25 TC	1.30	1.55	1.75	5.00	5.80	70.00
4	FLAMEX 20 4x 1.00 BLG	18	1.00	19x0.25 TC	1.30	1.45	1.80	5.00	6.00	65.00
4	FLAMEX 20 4x 1.34 BLG	16	1.34	19x0.30 TC	1.55	1.80	2.00	5.70	6.50	89.00
4	FLAMEX 20 4x 1.50 BLG	16	1.50	37x0.23 TC	1.65	1.95	2.30	6.00	7.00	100.00
4	FLAMEX 20 4x 1.82 BLG	14	1.82	37x0.25 TC	1.82	2.10	2.40	6.45	7.25	109.00
4	FLAMEX 20 4x 2.50 BLG	14	2.50	37x0.30 TC	2.15	2.50	2.85	7.50	8.50	158.00
4	FLAMEX 20 4x 2.61 BLG	14	2.61	37x0.30 TC	2.28	2.50	2.80	7.65	8.45	157.00
4	FLAMEX 20 4x 4.32 BLG	12	4.32	61x0.30 TC	2.90	3.00	3.30	9.05	9.85	237.00

TC = Tinned copper

EPDX-ZH, KY TYPE

**Halogen free
unscreened hook-up wires**

Applications

These wires are mainly designed for internal wiring in electronic equipment. Halogen free, they are intended to be used in places where the protection of the people and equipment is vital.

We recommend to use them for cabinet wiring in public areas such as railway or subway stations but also in industrial areas, etc...

250 and 750 Volts

Construction

1- CONDUCTOR

Stranded annealed tinned copper wires







2- INSULATION

Halogen free

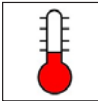

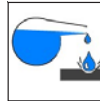
Standards

NEXANS specification

							
- 40°C to +105°C	Flame retardant (NF C 32-070/C2, IEC 60332-1/2)	Low smoke emission and low opacity (IEC 61034)	Non corrosive and non toxic (IEC 60754-2)	Flexible	Screened versions	Halogen free (IEC 60754-1)	RoHS

■ **KY/EPDX-ZH, KY type - Halogen free unscreened hook-up wires - 250 volts**

Nexans Reference	CONDUCTOR			Overall diameter mm	Average weight Kg/Km
	Gauge AWG	Cross section mm ²	Construction n x Ø mm		
EPDX-ZH 6x0	30	0.055	7 x 0.10	0.75 ± 0.05	1.05
EPDX-ZH 5x0	28	0.079	7 x 0.12	0.81 ± 0.05	1.35
EPDX-ZH 4x0	26	0.120	7 x 0.15	0.90 ± 0.10	1.75
EPDX-ZH 000	24	0.22	7 x 0.20	1.10 ± 0.10	2.90
EPDX-ZH 00	22	0.34	7 x 0.25	1.30 ± 0.10	4.35
EPDX-ZH 26	20	0.60	19 x 0.20	1.75 ± 0.15	7.60
EPDX-ZH 27	18	0.93	19 x 0.25	2.00 ± 0.15	11.05
EPDX-ZH 28	16	1.34	19 x 0.30	2.35 ± 0.15	15.85
EPDX-ZH 29	14	1.91	27 x 0.30	2.70 ± 0.15	22.00
EPDX-ZH 100	12	3.18	45 x 0.30	3.40 ± 0.20	36.00
EPDX-ZH 140	10	5.15	73 x 0.30	4.10 ± 0.20	56.50

■ **KY/EPDX-ZH, KY type- Halogen free unscreened hook-up wires - 750 volts**

Nexans Reference	CONDUCTOR			Overall diameter mm	Average weight Kg/Km
	Gauge AWG	Cross section mm ²	Construction n x Ø mm		
EPDX-ZH 6	24	0.22	7 x 0.20	1.70 ± 0.10	5.00
EPDX-ZH 7	22	0.38	12 x 0.20	2.15 ± 0.15	8.00
EPDX-ZH 16	20	0.60	19 x 0.20	2.35 ± 0.15	10.50
EPDX-ZH 17	18	1.00	32 x 0.20	2.65 ± 0.15	15.50
EPDX-ZH 8	16	1.34	19 x 0.30	2.85 ± 0.15	19.00
EPDX-ZH 9	14	1.91	27 x 0.30	3.20 ± 0.20	25.50
EPDX-ZH 10	12	3.18	45 x 0.30	4.00 ± 0.20	41.50
EPDX-ZH 14	10	5.15	73 x 0.30	4.60 ± 0.20	62.00

150°C

Applications

Flexible and lightweight range of cables with FEP + super-polyamide insulation for use in bundles.

Abrasion resistance: medium

They withstand most chemical fluids except for concentrated nitric acid.

600 Volts RMS

Construction

1- CONDUCTOR

stranded tinned copper wires or stranded tinned copper alloy wires for the cross section area 0.21 mm²

2- INSULATION

fluoropolymer (FEP)

3- OUTER JACKET

superpolyamide (radial thickness: from 0.10 mm up to 0.15 mm)



Technical requirements and control conditions

Air 4524 specification of September 1965 - the 105°/135°C category, NF-L 52-120B BNAé specification of December 1971 - Lightweight cables.

Colour coding

To AIR 0107 A of October 1961 and note N° 348/SIB distributed under N° 5927/STT/SIB (3.05.1961).

Standards

To AIR 4524 and MIL-W 5086B/7A specifications.

These cables are approved by the Air Ministry under letters:

N° 34722 STA/EQ/E2 (18-4-69) for AWG 24

N° 41763 STA/EQ/E2 (12-11-68) for AWG 22 up to AWG 12

Registered at B.N.Ae:

N° 6412 420 A

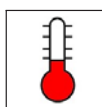

- 50°C to +140°C



Fire retardant
(NF C 32-070/C1)



Flexible



RoHS

1806 - Unscreened hook-up wires

Nexans Reference			CONDUCTOR			CORE		DC resist. at 20°C (maxi.) Ω / km	Current rating A	Colour of cores
Type	Cross section	AWG	Construction n x \varnothing mm	Nominal \varnothing mm	Tensile strength daN.	Overall diameter mm	Average weight Kg/Km			
1806	0.21	24	19 x 0.12 T.P.C All.	0.60	7	1.10 + 0.05	3.10	105.0	4	Light Blue
1806	0.38	22	12 x 0.20 T.P.C.	0.80	8	1.33 + 0.05	5.10	50.9	7	White
1806	0.60	20	19 x 0.20 T.P.C.	1.00	16	1.49 + 0.05	7.10	32.2	11	Light Blue
1806	0.93	18	19 x 0.25 T.P.C.	1.20	20	1.69 + 0.05	10.4	20.6	16	White
1806	1.34	16	19 x 0.30 T.P.C.	1.50	20	1.97 + 0.05	14.6	14.3	22	Light Blue
1806	1.91	14	27 x 0.30 T.P.C.	1.80	20	2.35 + 0.05	21.0	10.1	32	White
1806	3.18	12	45 x 0.30 T.P.C.	2.30	20	2.94 + 0.05	34.0	6.0	41	White

The shown current rating is valid for singles wires in air.

Applications

Flexible and lightweight range of cables with FEP + super-polyamide insulation for use in bundles.

Abrasion resistance: medium

They withstand most chemical fluids except for concentrated nitric acid.

600 Volts RMS

Construction

BASE CORE 1806

1- CONDUCTOR

stranded tinned copper wires or stranded tinned copper alloy wires for the cross section area 0.21 mm

2- INSULATION

fluoropolymer (FEP)

3- OUTER JACKET

superpolyamide (radial thickness: from 0.10 mm up to 0.15 mm)

806

4- LAY UP

1 or several 1806 cores

5- SCREEN

tinned copper braid (Kr ≥ 62%)

6- OUTER JACKET

superpolyamide (radial thickness: about 0.20 mm)



Technical requirements and control conditions

Screen: to MIL.C. 7078C (August 1971) U.S. specification.

Colour coding

To Air 0107 A (October 1961) and note N° 348/SIB distributed under N° 5927/STT/SIB (3-05-1961).

Standards

To AIR 4524 and MIL-W 5086B/7A specifications.

These cables are approved by the Air Ministry under letters:

N° 34722 STA/EQ/E2 (18-4-69) for AWG 24

N° 41763 STA/EQ/E2 (12-11-68) for AWG 22 up to AWG 12

Registered at B.N.Ae : N° 6412 420 A

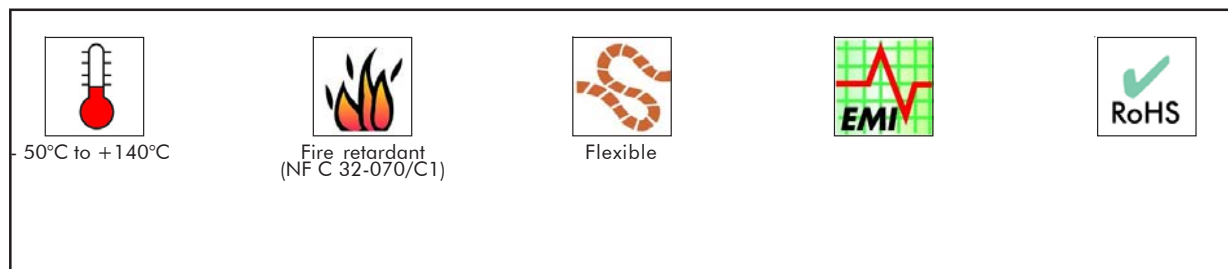

806 - Screened and jacketed hook-up wires and multicore cables

Nb of cores	Nexans Reference				BASE CORE : 1806			SERIE 806		
					Construction n x Ø mm	Overall diameter nominal mm	Colour coding of cores	Colour of outer jacket	Overall diameter (maxi.) mm	Average weight Kg/Km
1	806	1	0.21	G 24	19 x 0.12 T.P.C All	1.10	Light blue	Light blue	2	6.3
1	806	1	0.38	G 22	12 x 0.20 T.P.C.	1.33	White	White	2.3	10.8
1	806	1	0.60	G 20	19 x 0.20 T.P.C.	1.49	Light blue	Light blue	2.5	13.3
1	806	1	0.93	G 18	19 x 0.25 T.P.C.	1.69	White	White	2.7	17.3
1	806	1	1.34	G 16	19 x 0.30 T.P.C.	1.97	Light blue	Light blue	3	22.5
1	806	1	1.91	G 14	27 x 0.30 T.P.C.	2.35	White	White	3.3	29.9
1	806	1	3.18	G 12	45 x 0.30 T.P.C.	2.94	White	White	4.2	47.0
2	806	2	0.21	G 24	19 x 0.12 T.P.C All	1.10	Light blue + Blue	Light blue	3.3	13.1
2	806	2	0.38	G 22	12 x 0.20 T.P.C.	1.33	White + Blue	White	3.8	19.0
2	806	2	0.60	G 20	19 x 0.20 T.P.C.	1.49	Light blue + Blue	Light blue	4.1	24.0
2	806	2	0.93	G 18	19 x 0.25 T.P.C.	1.69	White + blue	White	4.5	33.7
2	806	2	1.34	G 16	19 x 0.30 T.P.C.	1.97	Light blue + Blue	Light blue	5.2	44.1
2	806	2	1.91	G 14	27 x 0.30 T.P.C.	2.35	White + Blue	White	5.9	59.0
2	806	2	3.18	G 12	45 x 0.30 T.P.C.	2.94	White + Blue	White	7.7	94.0
3	806	3	0.21	G 24	19 x 0.12 T.P.C All	1.10	Light blue + Blue + Yellow	Light blue	3.5	17.5
3	806	3	0.38	G 22	12 x 0.20 T.P.C.	1.33	White + Blue + Yellow	White	4	25.9
3	806	3	0.60	G 20	19 x 0.20 T.P.C.	1.49	Light blue + Blue + Yellow	Light blue	4.4	35.0
3	806	3	0.93	G 18	19 x 0.25 T.P.C.	1.69	White + Blue + Yellow	White	4.8	46.8
3	806	3	1.34	G 16	19 x 0.30 T.P.C.	1.97	Light blue + Blue + Yellow	Light blue	5.5	61.9
3	806	3	1.91	G 14	27 x 0.30 T.P.C.	2.35	White + Blue + Yellow	White	6.3	83.6
3	806	3	3.18	G 12	45 x 0.30 T.P.C.	2.94	White + Blue + Yellow	White	8.2	134
4	806	4	0.21	G 24	19 x 0.12 T.P.C All	1.10	Light Blue + Blue + Yellow + Green	Light blue	3.7	21.6
4	806	4	0.38	G 22	12 x 0.20 T.P.C.	1.33	White + Blue + Yellow + Green	White	4.4	34.4
4	806	4	0.60	G 20	19 x 0.20 T.P.C.	1.49	Light blue + Blue + Yellow + Green	Light blue	4.8	43.9
4	806	4	0.93	G 18	19 x 0.25 T.P.C.	2.69	White + Blue + Yellow + Green	White	5.3	59.3
4	806	4	1.34	G 16	19 x 0.30 T.P.C.	2.97	Light blue + Blue + Yellow + Green	Light blue	6	79.0
4	806	4	1.91	G 14	27 x 0.30 T.P.C.	2.35	White + Blue + Yellow + Green	White	6.9	107.4
4	806	4	3.18	G 12	45 x 0.30 T.P.C.	2.94	White + Blue + Yellow + Green	White	9.1	172.5

KU

Unscreened hook up wires, pairs and triples

Applications

Internal wiring in electronic equipment.

600 volts

Construction

BASE CORE KU 01

1- CONDUCTOR

stranded annealed tinned copper wires

2- INSULATION

ethylene and tetrafluorethylene copolymer (E.T.F.E)

KU 03 and KU 04

3- LAY UP

2 or 3 base cores

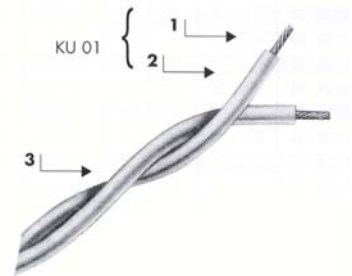

Standards

NF C 93-524

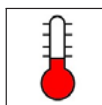

-55 °C to +150 °C



Flame and fire retardant
(NF C 32-070/C1 & C2)



Flexible



RoHS

KU - Unscreened hook up wires

NFC 93524 and Nexans references	Gauge AWG	Cross section mm ²	Construction n x Ø mm	Overall diameter		Average weight Kg / Km
				mini.	maxi.	
				mm		
KU01-30	30	0.05	7 x 0.10	0.58	0.64	0.88
KU01-28	28	0.09	7 x 0.13	0.64	0.70	1.25
KU01-26	26	0.15	19 x 0.10	0.76	0.82	1.93
KU01-24	24	0.25	19 x 0.13	0.86	0.92	2.88
KU01-22	22	0.38	19 x 0.16	1.05	1.11	4.36
KU01-20	20	0.60	19 x 0.20	1.47	1.53	6.98
KU01-18	18	0.93	19 x 0.25	1.75	1.81	10.89
KU01-16	16	1.34	19 x 0.30	1.93	2.03	14.79
KU01-14	14	1.82	37 x 0.25	2.26	2.42	20.58
KU01-12	12	3.00	37 x 0.32	2.79	2.95	32.95

KU - Pairs and triples

Nb of cores	NFC 93524 and Nexans references	BASE CORE					Overall diameter		Average weight Kg / Km	Colour coding of cores
		Type	CONDUCTOR			Nom Ø core mm	mini.	maxi.		
			Gauge AWG	Cross section mm ²	Construction n x Ø mm		mm			
2	KU03 - 30	KU 01 - 30	30	0.05	7 x 0.10	0.61	1.16	1.36	1.85	White Blue
2	KU03 - 28	KU 01 - 28	28	0.09	7 x 0.13	0.67	1.28	1.48	2.62	
2	KU03 - 26	KU 01 - 26	26	0.15	19 x 0.10	0.79	1.52	1.72	4.05	
2	KU03 - 24	KU 01 - 24	24	0.25	19 x 0.13	0.89	1.72	1.92	6.04	
2	KU03 - 22	KU 01 - 22	22	0.38	19 x 0.16	1.08	2.10	2.30	9.16	
2	KU03 - 20	KU 01 - 20	20	0.60	19 x 0.20	1.5	2.94	3.14	15.18	
2	KU03 - 18	KU 01 - 18	18	0.93	19 X 0.25	1.78	3.50	3.70	22.83	
2	KU03 - 16	KU 01 - 16	16	1.34	19 X 0.30	1.98	3.86	4.14	31.00	
2	KU03 - 14	KU 01 - 14	14	1.82	37 X 0.25	2.34	4.52	4.92	43.14	
2	KU03 - 12	KU 01 - 12	12	3.00	37 X 0.32	2.87	5.58	5.98	69.06	
3	KU04 - 30	KU 01 - 30	30	0.05	7 x 0.10	0.61	1.25	1.46	2.72	White Blue Orange
3	KU04 - 28	KU 01 - 28	28	0.09	7 x 0.13	0.67	1.38	1.58	3.86	
3	KU04 - 26	KU 01 - 26	26	0.15	19 x 0.10	0.79	1.63	1.85	5.97	
3	KU04 - 24	KU 01 - 24	24	0.25	19 x 0.13	0.89	1.85	2.06	8.90	
3	KU04 - 22	KU 01 - 22	22	0.38	19 x 0.16	1.08	2.26	2.47	13.50	
3	KU04 - 20	KU 01 - 20	20	0.60	19 x 0.20	1.5	3.16	3.38	22.37	
3	KU04 - 18	KU 01 - 18	18	0.93	19 X 0.25	1.78	3.76	3.98	33.65	
3	KU04 - 16	KU 01 - 16	16	1.34	19 X 0.30	1.98	4.15	4.45	45.70	
3	KU04 - 14	KU 01 - 14	14	1.82	37 X 0.25	2.34	4.86	5.29	63.59	
3	KU04 - 12	KU 01 - 12	12	3.00	37 X 0.32	2.87	6.00	6.43	101.81	

KU

Screened and jacketed hook-up wires, pairs and triples

Applications

Internal wiring in electronic equipment.

600 volts

Construction

BASE CORE KU 01

1- CONDUCTOR

stranded annealed tinned copper wires

2- INSULATION

ethylene and tetrafluorethylene copolymer (E.T.F.E)

3- SCREEN

tinned copper braid



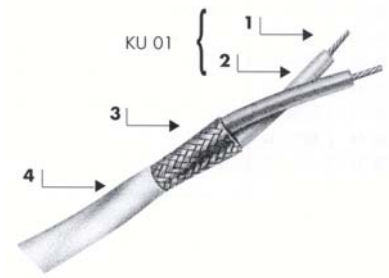

4- OUTER JACKET

ethylene and tetrafluorethylene copolymer (E.T.F.E.)

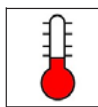

Standards

NF C 93-524

 <p>-55 °C to +150 °C</p>	 <p>Flame and fire retardant (NF C 32-070/C1 & C2)</p>	 <p>Flexible</p>		
--	---	---	---	---

KU - Screened and jacketed hook-up wires

Nb of cores	NFC 93524 and Nexans references	BASE CORE				Nom Ø core mm	Overall diameter		Average weight Kg / Km
		Type	CONDUCTOR				mini.	maxi.	
			Gauge AWG	Cross section mm ²	Construction n x Ø mm				
1	KU 02 - 30	KU 01 - 30	30	0.05	7 x 0.10	0.61	1.35	1.43	4.10
1	KU 02 - 28	KU 01 - 28	28	0.09	7 x 0.13	0.67	1.41	1.49	4.68
1	KU 02 - 26	KU 01 - 26	26	0.15	19 x 0.10	0.79	1.51	1.59	5.70
1	KU 02 - 24	KU 01 - 24	24	0.25	19 x 0.13	0.89	1.73	1.81	7.55
1	KU 02 - 22	KU 01 - 22	22	0.38	19 x 0.16	1.08	1.96	2.06	10.02
1	KU 02 - 20	KU 01 - 20	20	0.60	19 x 0.20	1.5	2.38	2.48	14.54
1	KU 02 - 18	KU 01 - 18	18	0.93	19 X 0.25	1.78	2.76	2.88	20.72
1	KU 02 - 16	KU 01 - 16	16	1.34	19 X 0.30	1.98	2.94	3.06	25.36
1	KU 02 - 14	KU 01 - 14	14	1.82	37 X 0.25	2.34	3.26	3.40	32.48
1	KU 02 - 12	KU 01 - 12	12	3.00	37 X 0.32	2.87	3.75	3.95	47.06

KU - Screened and jacketed pairs and triples

Nb of cores	NFC 93524 and Nexans references	BASE CORE				Nom Ø core mm	Overall diameter		Average weight Kg / Km	Colour coding of cores
		Type	CONDUCTOR				mini.	maxi.		
			Gauge AWG	Cross section mm ²	Construction n x Ø mm					
2	KU 05 - 30	KU 01 - 30	30	0.05	7 x 0.10	0.61	2.12	2.22	7.60	White Blue
2	KU 05 - 28	KU 01 - 28	28	0.09	7 x 0.13	0.67	2.24	2.34	8.80	
2	KU 05 - 26	KU 01 - 26	26	0.15	19 x 0.10	0.79	2.48	2.60	11.15	
2	KU 05 - 24	KU 01 - 24	24	0.25	19 x 0.13	0.89	2.79	2.91	15.11	
2	KU 05 - 22	KU 01 - 22	22	0.38	19 x 0.16	1.08	3.16	3.30	19.77	
2	KU 05 - 20	KU 01 - 20	20	0.60	19 x 0.20	1.5	3.87	4.07	28.11	
2	KU 05 - 18	KU 01 - 18	18	0.93	19 x 0.25	1.78	4.52	4.72	38.95	
2	KU 05 - 16	KU 01 - 16	16	1.34	19 x 0.30	1.98	4.90	5.12	48.59	
2	KU 05 - 14	KU 01 - 14	14	1.82	37 x 0.25	2.34	5.62	5.86	63.75	
2	KU 05 - 12	KU 01 - 12	12	3.00	37 x 0.32	2.87	6.67	6.97	94.29	
3	KU 06 - 30	KU 01 - 30	30	0.05	7 x 0.10	0.61	2.32	2.42	9.60	White Blue Orange
3	KU 06 - 28	KU 01 - 28	28	0.09	7 x 0.13	0.67	2.36	2.46	10.70	
3	KU 06 - 26	KU 01 - 26	26	0.15	19 x 0.10	0.79	2.70	2.82	14.89	
3	KU 06 - 24	KU 01 - 24	24	0.25	19 x 0.13	0.89	2.83	2.95	18.09	
3	KU 06 - 22	KU 01 - 22	22	0.38	19 x 0.16	1.08	3.23	3.37	24.36	
3	KU 06 - 20	KU 01 - 20	20	0.60	19 x 0.20	1.5	4.13	4.33	37.00	
3	KU 06 - 18	KU 01 - 18	18	0.93	19 x 0.25	1.78	4.72	4.94	50.70	
3	KU 06 - 16	KU 01 - 16	16	1.34	19 x 0.30	1.98	5.18	5.40	64.90	
3	KU 06 - 14	KU 01 - 14	14	1.82	37 x 0.25	2.34	5.96	6.22	86.37	
3	KU 06 - 12	KU 01 - 12	12	3.00	37 x 0.32	2.87	7.09	7.39	129.53	

BRAID: Ø STRANDS

Reference	AWG	Ø mm
KU 02	From AWG 30 to AWG 20	0.10
KU 02	From AWG 18 to AWG 12	0.12
KU 05	From AWG 30 to AWG 26	0.10
KU 05	From AWG 24 to AWG 12	0.12
KU 06	From AWG 30 to AWG 28	0.10
KU 06	From AWG 24 to AWG 12	0.12

200°C

KZ 04, KZ 05, KZ 06

Unscreened hook-up wires
High temperature

Applications

Internal wiring in electronic equipment.
Aircrafts and satellites.
Excellent chemical resistance.
In order to increase the operating temperature of the cables up to 250°C, all KZ types can be produced with a nickel plated copper conductor on request.

from 250 to 1000 Volts

Construction

1- CONDUCTOR

stranded silvered copper wires

2- INSULATION

extruded polytetrafluorethylene (P.T.F.E.)

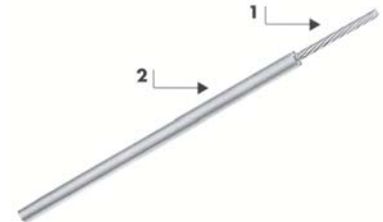

Standards

NF C 93-523

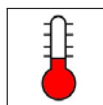

-55 °C to +200 °C



Fire retardant
(NF C 32-070/C1)



Flexible



RoHS

KZ - Unscreened hook-up wires, high temperature

NFC 93523 and Nexans references	Gauge AWG	Cross section mm ²	Construction n x Ø mm	Nom. Ø mm	D.C. resist. at 20°C maxi. (Ohms/Km)	Overall diameter		Maximum weight Kg / Km	Operating voltage Volts
						mini. mm	maxi. mm		
KZ 04 - 01	32	0.035	7 x 0.08	0.24	546	0.48	0.58	0.95	250
KZ 04 - 02	30	0.055	7 x 0.10	0.30	349	0.56	0.66	1.3	
KZ 04 - 03	28	0.093	7 x 0.13	0.39	201	0.63	0.73	1.75	
KZ 04 - 04	26	0.14	7 x 0.16	0.48	132	0.74	0.84	2.4	
KZ 04 - 05	24	0.22	7 x 0.20	0.60	86	0.86	0.96	3.4	
KZ 04 - 06	22	0.34	7 x 0.25	0.75	54.4	1.01	1.11	5.0	
KZ 04 - 07	20	0.60	19 x 0.20	1.00	31.3	1.30	1.40	8.25	
KZ 05 - 01	32	0.035	7 x 0.08	0.24	546	0.63	0.84	1.65	600
KZ 05 - 02	30	0.055	7 x 0.10	0.30	349	0.71	0.91	2.1	
KZ 05 - 03	28	0.093	7 x 0.13	0.39	201	0.79	1.00	2.6	
KZ 05 - 04	26	0.14	7 x 0.16	0.48	132	0.89	1.10	3.4	
KZ 05 - 05	24	0.22	7 x 0.20	0.60	86	1.04	1.22	4.5	
KZ 05 - 06	22	0.34	7 x 0.25	0.75	54.4	1.17	1.37	6.2	
KZ 05 - 07	20	0.60	19 x 0.20	1.00	31.3	1.42	1.62	9.5	
KZ 05 - 08	18	0.93	19 x 0.25	1.25	20.5	1.67	1.92	14.1	
KZ 05 - 09	16	1.34	19 x 0.30	1.50	13.9	1.92	2.27	20.0	
KZ 05 - 10	14	1.91	27 x 0.30	1.85	10.0	2.30	2.66	27.0	
KZ 05 - 11	12	3.18	45 x 0.30	2.45	6.0	2.89	3.24	42.5	
KZ 06 - 01	32	0.035	7 x 0.08	0.24	546	0.88	1.09	2.6	1000
KZ 06 - 02	30	0.055	7 x 0.10	0.30	349	0.95	1.16	3.0	
KZ 06 - 03	28	0.093	7 x 0.13	0.39	201	1.04	1.24	3.7	
KZ 06 - 04	26	0.14	7 x 0.16	0.48	132	1.14	1.34	4.6	
KZ 06 - 05	24	0.22	7 x 0.20	0.60	86	1.27	1.47	5.75	
KZ 06 - 06	22	0.34	7 x 0.25	0.75	54.4	1.42	1.63	7.7	
KZ 06 - 07	20	0.60	19 x 0.20	1.00	31.3	1.66	1.86	11.0	
KZ 06 - 08	18	0.93	19 x 0.25	1.25	20.5	1.92	2.17	16.0	
KZ 06 - 09	16	1.34	19 x 0.30	1.50	13.9	2.10	2.41	21.1	
KZ 06 - 10	14	1.91	27 x 0.30	1.85	10.0	2.51	2.92	30.0	
KZ 06 - 11	12	3.18	45 x 0.30	2.45	6.0	3.14	3.55	47.5	

KZ 55, KZ 57, KZ 59

Screened and jacketed
hook-up wires
High temperature

Applications

Internal wiring in electronic equipment.
Aircrafts and satellites.
Excellent chemical resistance.
In order to increase the operating temperature of the cables up to 250°C, all KZ types can be produced with a nickel plated copper conductor on request.

from 250 to 1000 Volts

Construction

1- CONDUCTOR

stranded silvered copper wires

2- INSULATION

extruded polytetrafluoroethylene (P.T.F.E.)

3- SCREEN

Silvered copper braid

KZ 55 are reinforced with a polyimide tape.

4- OUTER JACKET

fluoropolymer (FEP) (radial thickness: 0.30 mm nominal)

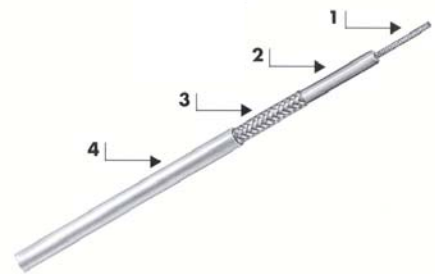

Colour coding

- White core
- White outer jacket

Standards

NF C 93-523

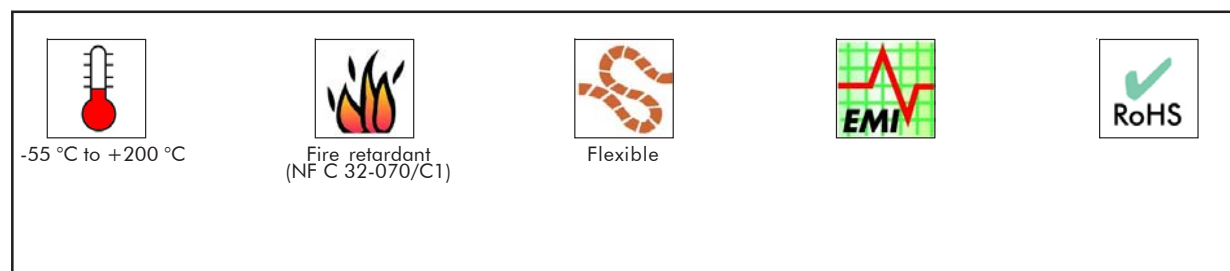

KZ - Screened and jacketed hook-up wires, high temperature

NFC 93523 and Nexans references	BASE CORE					D.C. resist. at 20°C maxi. (Ohms/ Km)	Braid nom Ø. of strands mm	Overall diameter		Maximum weight Kg / Km	Operating voltage Volts
	Type	CONDUCTOR						mini.	maxi.		
		Gauge AWG	Cross section mm ²	Construction n x Ø mm	Nom. Ø mm			mm			
KZ 55-04	KZ 04-04	26	0.14	7 x 0.16	0.48	132	0.10	1.85	2.05	8.11	250
KZ 55-05	KZ 04-05	24	0.22	7 x 0.20	0.60	86	0.10	1.97	2.17	9.66	
KZ 55-06	KZ 04-06	22	0.34	7 x 0.25	0.75	54.4	0.10	2.12	2.32	11.90	
KZ 55-07	KZ 04-07	20	0.60	19 x 0.20	1.00	31.3	0.10	2.40	2.60	16.50	
KZ 57-01	KZ 05-01	32	0.035	7 x 0.08	0.24	546	0.10	1.72	1.97	6.72	600
KZ 57-02	KZ 05-02	30	0.055	7 x 0.10	0.30	349	0.10	1.79	2.04	7.49	
KZ 57-03	KZ 05-03	28	0.093	7 x 0.13	0.39	201	0.10	1.88	2.13	8.39	
KZ 57-04	KZ 05-04	26	0.14	7 x 0.16	0.48	132	0.10	1.98	2.23	9.63	
KZ 57-05	KZ 05-05	24	0.22	7 x 0.20	0.60	86	0.10	2.11	2.36	11.30	
KZ 57-06	KZ 05-06	22	0.34	7 x 0.25	0.75	54.4	0.10	2.25	2.50	13.60	
KZ 57-07	KZ 05-07	20	0.60	19 x 0.20	1.00	31.3	0.13	2.65	2.90	20.00	
KZ 57-08	KZ 05-08	18	0.93	19 x 0.25	1.25	20.5	0.13	2.93	3.18	26.10	
KZ 57-09	KZ 05-09	16	1.34	19 x 0.30	1.50	13.9	0.13	3.23	3.53	33.50	
KZ 57-10	KZ 05-10	14	1.91	27 x 0.30	1.85	10.0	0.13	3.61	3.91	42.60	
KZ 57-11	KZ 05-11	12	3.18	45 x 0.30	2.45	6.0	0.13	4.19	4.49	61.10	
KZ 59-01	KZ 06-01	32	0.035	7 x 0.08	0.24	546	0.10	1.97	2.22	8.79	1000
KZ 59-02	KZ 06-02	30	0.055	7 x 0.10	0.30	349	0.10	2.03	2.28	9.45	
KZ 59-03	KZ 06-03	28	0.093	7 x 0.13	0.39	201	0.10	2.12	2.37	10.6	
KZ 59-04	KZ 06-04	26	0.14	7 x 0.16	0.48	132	0.10	2.22	2.47	11.9	
KZ 59-05	KZ 06-05	24	0.22	7 x 0.20	0.60	86	0.10	2.35	2.60	13.6	
KZ 59-06	KZ 06-06	22	0.34	7 x 0.25	0.75	54.4	0.13	2.65	2.90	18.2	
KZ 59-07	KZ 06-07	20	0.60	19 x 0.20	1.00	31.3	0.13	2.89	3.14	22.7	
KZ 59-08	KZ 06-08	18	0.93	19 x 0.25	1.25	20.5	0.13	3.18	3.43	29.2	
KZ 59-09	KZ 06-09	16	1.34	19 x 0.30	1.50	13.9	0.13	3.38	3.68	35.4	
KZ 59-10	KZ 06-10	14	1.91	27 x 0.30	1.85	10.0	0.13	3.84	4.19	46.8	
KZ 59-11	KZ 06-11	12	3.18	45 x 0.30	2.45	6.0	0.13	4.65	5.00	70.4	

KZ 67, KZ 69, KZ 71

Screened and jacketed pairs
High temperature

Applications

Internal wiring in electronic equipment.
Aircrafts and satellites.

from 250 to 1000 Volts

Construction

1- CONDUCTOR

stranded silvered copper wires

2- INSULATION

extruded polytetrafluorethylene (P.T.F.E.)

3- SCREEN

Silvered copper braid
KZ 67 are reinforced with a polyimide tape.

4- OUTER JACKET

fluoropolymer (FEP) (radial thickness: 0.30 mm nominal)

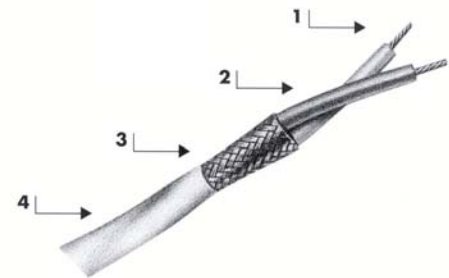





Colour coding

- Cores: white + light blue
- Outer jacket: white

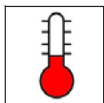
Standards

NF C 93-523

 -55 °C to +200 °C	 Fire retardant (NF C 32-070/C1)	 Flexible	 EMI	 RoHS
--	---	---	--	---

KZ - Screened and jacketed pairs, high temperature

NFC 93523 and Nexans references	BASE CORE					D.C. resist. at 20°C maxi. (Ohms/ Km)	Braid nom Ø. of strands mm	Overall diameter		Average weight Kg / Km	Operating voltage Volts
	Type	CONDUCTOR						mini.	maxi.		
		Gauge AWG	Cross section mm ²	Construction n x Ø mm	Ø Nom. mm			mm			
KZ 67-01	KZ 04-01	32	0.035	7 x 0.08	0.24	573	0.10	2.11	2.36	8.03	250
KZ 67-02	KZ 04-02	30	0.055	7 x 0.10	0.30	366	0.10	2.27	2.52	9.35	
KZ 67-03	KZ 04-03	28	0.093	7 x 0.13	0.39	211	0.10	2.41	2.62	10.8	
KZ 67-04	KZ 04-04	26	0.14	7 x 0.16	0.48	138	0.10	2.63	2.88	13.0	
KZ 67-05	KZ 04-05	24	0.22	7 x 0.20	0.60	90	0.13	3.02	3.27	17.9	
KZ 67-06	KZ 04-06	22	0.34	7 x 0.25	0.75	57	0.13	3.32	3.57	22.5	
KZ 67-07	KZ 04-07	20	0.60	19 x 0.20	1.00	33	0.13	3.90	4.15	31.7	
KZ 69-01	KZ 05-01	32	0.035	7 x 0.08	0.24	573	0.10	2.46	2.71	10.6	600
KZ 69-02	KZ 05-02	30	0.055	7 x 0.10	0.30	366	0.10	2.60	2.85	12.0	
KZ 69-03	KZ 05-03	28	0.093	7 x 0.13	0.39	211	0.10	2.78	3.03	13.7	
KZ 69-04	KZ 05-04	26	0.14	7 x 0.16	0.48	138	0.13	3.13	3.38	18.1	
KZ 69-05	KZ 05-05	24	0.22	7 x 0.20	0.60	90	0.13	3.39	3.64	21.5	
KZ 69-06	KZ 05-06	22	0.34	7 x 0.25	0.75	57	0.13	3.67	3.92	26.2	
KZ 69-07	KZ 05-07	20	0.60	19 x 0.20	1.00	33	0.13	4.17	4.42	35.1	
KZ 69-08	KZ 05-08	18	0.93	19 x 0.25	1.25	21.5	0.13	4.73	5.08	46.9	
KZ 69-09	KZ 05-09	16	1.34	19 x 0.30	1.50	14.6	0.13	5.51	5.86	64.4	
KZ 69-10	KZ 05-10	14	1.91	27 x 0.30	1.85	10.5	0.13	6.27	6.62	82.4	
KZ 69-11	KZ 05-11	12	3.18	45 x 0.30	2.45	6.3	0.13	7.43	7.78	120.0	
KZ 71-01	KZ 06-01	32	0.035	7 x 0.08	0.24	573	0.13	3.11	3.36	16.4	1000
KZ 71-02	KZ 06-02	30	0.055	7 x 0.10	0.30	366	0.13	3.23	3.48	17.7	
KZ 71-03	KZ 06-03	28	0.093	7 x 0.13	0.39	211	0.13	3.41	3.66	19.9	
KZ 71-04	KZ 06-04	26	0.14	7 x 0.16	0.48	138	0.13	3.61	3.86	22.6	
KZ 71-05	KZ 06-05	24	0.22	7 x 0.20	0.60	90	0.13	3.87	4.12	26.1	
KZ 71-06	KZ 06-06	22	0.34	7 x 0.25	0.75	57	0.13	4.17	4.42	31.4	
KZ 71-07	KZ 06-07	20	0.60	19 x 0.20	1.00	33	0.13	4.65	4.90	40.2	
KZ 71-08	KZ 06-08	18	0.93	19 x 0.25	1.25	21.5	0.13	5.39	5.64	55.6	
KZ 71-09	KZ 06-09	16	1.34	19 x 0.30	1.50	14.6	0.13	5.81	6.16	68.1	
KZ 71-10	KZ 06-10	14	1.91	27 x 0.30	1.85	10.5	0.13	6.73	7.08	90.7	
KZ 71-11	KZ 06-11	12	3.18	45 x 0.30	2.45	6.3	0.13	7.99	8.34	133	

KZ 79, KZ 81, KZ 83

Screened and jacketed triples
High temperature

Applications

Internal wiring in electronic equipment.
Aircrafts and satellites.

from 250 to 1000 Volts

Construction

1- CONDUCTOR

stranded silvered copper wires

2- INSULATION

extruded polytetrafluorethylene (P.T.F.E.)

3- SCREEN

Silvered copper braid

KZ 79 are reinforced with a polyimide tape.

4- OUTER JACKET

fluoropolymer (FEP) (radial thickness: 0.30 mm nominal)

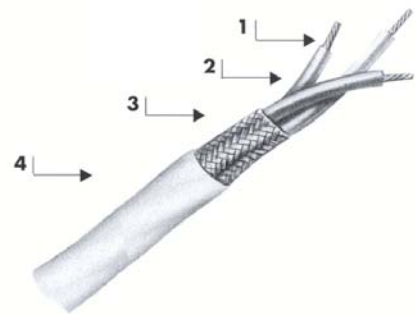





Colour coding

- Cores: white + light blue + orange
- Outer jacket: white

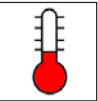
Standards

NF C 93-523

 -55 °C to +200 °C	 Fire retardant (NF C 32-070/C1)	 Flexible	 EMI	 RoHS
--	---	---	--	---

KZ - Screened and jacketed triples, high temperature

NFC 93523 and Nexans references	BASE CORE					D.C. resist. at 20°C maxi. (Ohms/ Km)	Braid nom Ø. of strands mm mini.	Overall diameter		Average weight Kg / Km	Operating voltage Volts
	Type	CONDUCTOR						mini.	maxi.		
		Gauge AWG	Cross section mm ²	Construction n x Ø mm	Ø Nom. mm			mm			
KZ 79-01	KZ 04-01	32	0.035	7 x 0.08	0.24	573	0.10	2.19	2.44	9.85	250
KZ 79-02	KZ 04-02	30	0.055	7 x 0.10	0.30	366	0.10	2.36	2.61	11.7	
KZ 79-03	KZ 04-03	28	0.093	7 x 0.13	0.39	211	0.10	2.51	2.76	13.7	
KZ 79-04	KZ 04-04	26	0.14	7 x 0.16	0.48	138	0.13	2.90	3.15	18.7	
KZ 79-05	KZ 04-05	24	0.22	7 x 0.20	0.60	90	0.13	3.15	3.40	23.1	
KZ 79-06	KZ 04-06	22	0.34	7 x 0.25	0.75	57	0.13	3.48	3.73	29.6	
KZ 79-07	KZ 04-07	20	0.60	19 x 0.20	1.00	33	0.13	4.10	4.35	42.7	
KZ 81-01	KZ 05-01	32	0.035	7 x 0.08	0.24	573	0.10	2.57	2.82	13.4	600
KZ 81-02	KZ 05-02	30	0.055	7 x 0.10	0.30	366	0.13	2.87	3.12	17.4	
KZ 81-03	KZ 05-03	28	0.093	7 x 0.13	0.39	211	0.13	3.07	3.32	19.9	
KZ 81-04	KZ 05-04	26	0.14	7 x 0.16	0.48	138	0.13	3.28	3.53	23.4	
KZ 81-05	KZ 05-05	24	0.22	7 x 0.20	0.60	90	0.13	3.56	3.81	28.2	
KZ 81-06	KZ 05-06	22	0.34	7 x 0.25	0.75	57	0.13	3.86	4.11	34.8	
KZ 81-07	KZ 05-07	20	0.60	19 x 0.20	1.00	33	0.13	4.40	4.65	47.6	
KZ 81-08	KZ 05-08	18	0.93	19 x 0.25	1.25	21.5	0.13	5.18	5.53	67.5	
KZ 81-09	KZ 05-09	16	1.34	19 x 0.30	1.50	14.6	0.13	5.83	6.18	89.1	
KZ 81-10	KZ 05-10	14	1.91	27 x 0.30	1.85	10.5	0.13	6.64	7.00	115	
KZ 81-11	KZ 05-11	12	3.18	45 x 0.30	2.45	6.3	0.13	7.89	8.24	169	
KZ 83-01	KZ 06-01	32	0.035	7 x 0.08	0.24	573	0.13	3.26	3.51	20.9	1000
KZ 83-02	KZ 06-02	30	0.055	7 x 0.10	0.30	366	0.13	3.39	3.64	22.7	
KZ 83-03	KZ 06-03	28	0.093	7 x 0.13	0.39	211	0.13	3.58	3.83	25.8	
KZ 83-04	KZ 06-04	26	0.14	7 x 0.16	0.48	138	0.13	3.80	4.05	29.6	
KZ 83-05	KZ 06-05	24	0.22	7 x 0.20	0.60	90	0.13	4.08	4.33	34.5	
KZ 83-06	KZ 06-06	22	0.34	7 x 0.25	0.75	57	0.13	4.40	4.65	42.1	
KZ 83-07	KZ 06-07	20	0.60	19 x 0.20	1.00	33	0.13	5.09	5.34	57.6	
KZ 83-08	KZ 06-08	18	0.93	19 x 0.25	1.25	21.5	0.13	5.70	6.15	76.2	
KZ 83-09	KZ 06-09	16	1.34	19 x 0.30	1.50	14.6	0.13	6.15	6.60	94.8	
KZ 83-10	KZ 06-10	14	1.91	27 x 0.30	1.85	10.5	0.13	7.14	7.59	127	
KZ 83-11	KZ 06-11	12	3.18	45 x 0.30	2.45	6.3	0.13	8.49	8.94	188	

ETF, EF & EEF

Unscreened hook-up wires
High temperature

Applications

Internal wiring in electronic equipment.
Aircrafts and satellites.
Excellent chemical resistance.
In order to increase the operating temperature of the cables up to 250°C, all KZ types can be produced with a nickel plated copper conductor on request.

from 250 to 1000 Volts

Construction

1- CONDUCTOR

stranded silvered copper wires

2- INSULATION

extruded polytetrafluorethylene (P.T.F.E.)

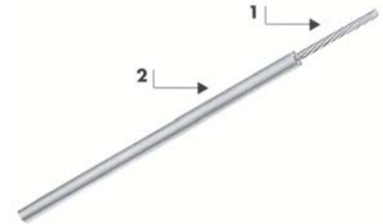

Standards

To MIL W 16878/4 (EF) ,
16878/5 (EEF), 16878/6 (ETF)
U.S. specification

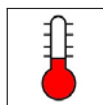

-55 °C to +200 °C



Fire retardant
(NF C 32-070/C1)



Flexible



RoHS

ETF, EF & EEF - Unscreened hook-up wires, high temperature

Nexans Reference	Gauge AWG	Cross section mm ²	Construction n x Ø mm	Nom. Ø mm	Overall diameter		Operating voltage Volts
					mini.	maxi.	
					mm		
ETF 32-07	32	0.035	7 x 0.079	0.24	0.50	0.61	250
ETF 30-07	30	0.057	7 x 0.102	0.30	0.56	0.66	
ETF 30-19	30	0.054	19 x 0.06	0.30	0.56	0.66	
ETF 28-07	28	0.089	7 x 0.127	0.39	0.63	0.74	
ETF 28-19	28	0.093	19 x 0.079	0.39	0.63	0.74	
ETF 26-07	26	0.14	7 x 0.16	0.48	0.74	0.84	
ETF 26-19	26	0.15	19 x 0.102	0.48	0.74	0.84	
ETF 24-07	24	0.22	7 x 0.203	0.59	0.86	0.96	
ETF 24-19	24	0.24	19 x 0.127	0.63	0.86	0.96	
ETF 22-07	22	0.36	7 x 0.254	0.74	1.01	1.12	
ETF 22-19	22	0.38	19 x 0.16	0.78	1.01	1.12	
ETF 20-07	20	0.56	7 x 0.32	0.95	1.22	1.32	
ETF 20-19	20	0.61	19 x 0.203	0.97	1.22	1.32	
EF 32-07	32	0.035	7 x 0.079	0.24	0.66	0.86	
EF 30-07	30	0.057	7 x 0.102	0.30	0.71	0.91	
EF 30-19	30	0.054	19 x 0.06	0.34	0.71	0.91	
EF 28-07	28	0.089	7 x 0.127	0.39	0.79	1.00	
EF 28-19	28	0.093	19 x 0.079	0.39	0.79	1.00	
EF 26-07	26	0.14	7 x 0.16	0.48	0.89	1.10	
EF 26-19	26	0.15	19 x 0.102	0.48	0.89	1.10	
EF 24-07	24	0.22	7 x 0.203	0.59	1.02	1.22	
EF 24-19	24	0.24	19 x 0.127	0.63	1.02	1.22	
EF 22-07	22	0.36	7 x 0.254	0.74	1.17	1.37	
EF 22-19	22	0.38	19 x 0.16	0.78	1.17	1.37	
EF 20-07	20	0.56	7 x 0.32	0.95	1.37	1.57	
EF 20-19	20	0.61	19 x 0.203	0.97	1.37	1.57	
EF 18-07	18	0.89	7 x 0.404	1.19	1.63	1.88	
EF 18-19	18	0.96	19 x 0.254	1.21	1.63	1.88	
EF 16-19	16	1.23	19 x 0.287	1.45	1.85	2.21	
EEF 32-07	32	0.035	7 x 0.079	0.24	0.91	1.12	1000
EEF 30-07	30	0.057	7 x 0.102	0.30	0.97	1.17	
EEF 30-19	30	0.054	19 x 0.06	0.34	0.97	1.17	
EEF 28-07	28	0.089	7 x 0.127	0.39	1.04	1.24	
EEF 28-19	28	0.093	19 x 0.079	0.39	1.04	1.24	
EEF 26-07	26	0.14	7 x 0.16	0.48	1.14	1.35	
EEF 26-19	26	0.15	19 x 0.102	0.48	1.14	1.35	
EEF 24-07	24	0.22	7 x 0.203	0.59	1.27	1.47	
EEF 24-19	24	0.24	19 x 0.127	0.63	1.27	1.47	
EEF 22-07	22	0.36	7 x 0.254	0.74	1.42	1.63	
EEF 22-19	22	0.38	19 x 0.16	0.78	1.42	1.63	
EEF 20-07	20	0.56	7 x 0.32	0.95	1.63	1.83	
EEF 20-19	20	0.61	19 x 0.203	0.97	1.63	1.83	
EEF 18-07	18	0.89	7 x 0.404	1.19	1.88	2.13	
EEF 18-19	18	0.96	19 x 0.254	1.21	1.88	2.13	
EEF 16-19	16	1.23	19 x 0.287	1.45	2.10	2.41	

250°C

1900 A

**Flexible cables
for high ambient temperatures
Light weight cables**

Applications

These cables may be used at high ambient temperatures, up to 280°C at peak.
They can be used in bundles.
They are non-flammable.
They withstand most chemical fluids.

600 Volts RMS

Construction

1- CONDUCTOR

stranded nickel plated copper or nickel plated copper alloy wires for the cross section area 0.21 mm² (high mechanical resistance)

2- INSULATION

PTFE

- extruded (from 0.21 to 1.34 mm²),
- wrapped and fused (1.91 and 3.18 mm²).

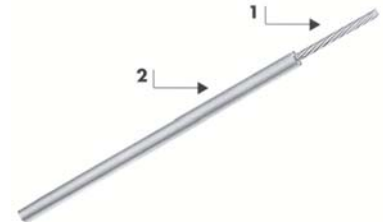

Technical requirements and control conditions

Air 4524 specification of September 1965 - the 250°/280°C category,
NF-L 52-125 A BNAé specification of December 1971 - Category C
- Lightweight cables.

Standards

To AIR 4524, B.N.Aé
These cables are approved by the Air Ministry under letters:
N°31951 STA/EQ/E2 (02-67) for AWG 24
N°40204 STA/EQ/E2 (10-63) for AWG 20 up to AWG 12
Registered at B.N.Ae: :
N° 6418 430 B

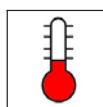

-50 °C ÷ +250 °C



AIR 4524



Flexible



RoHS

■ 1900 A - Flexible cables for high ambient temperatures, light weight cables

Type	Cross section	US AWG	CONDUCTOR			CORE			ELECTRICAL VALUES	
			Construction	nominal Ø	Tensile strength	Overall diameter mm		Average weight Kg/Km	DC resist. at 20°C Ω / km	Current rating
			n x Ø mm	mm	daN	Min.	Max.	Max.	Max.	A
1900 A	0.21	24	19 x 0.12 N. P. All.	0.59	7.3	1.15	1.25	4.18	112.3	4
1900 A	0.38	22	12 x 0.20 N.P.C.	0.78	8.0	1.35	1.50	6.64	54.50	7
1900 A	0.60	20	19 x 0.20 N.P.C.	0.98	16.0	1.55	1.70	9.32	34.40	11
1900 A	0.93	18	19 x 0.25 N.P.C.	1.22	> 20.0	1.80	2.00	13.53	22.00	16
1900 A	1.34	16	19 x 0.30 N.P.C.	1.47	> 20.0	2.10	2.30	18.39	15.30	22
1900 A	1.91	14	27 x 0.30 N.P.C.	1.74	> 20.0	-	2.60	24.37	10.80	32
1900 A	3.18	12	45 x 0.30 N.P.C.	2.25	> 20.0	-	3.30	38.14	6.40	41

N.P.All. = nickel plated annealed copper alloy – N.P.C. = nickel plated annealed electrolytic copper

The currents shown are valid for single wires in air.

2100

Flexible cables for high ambient temperature

Applications

These cables are designed for use at high ambient temperatures up to 289°C at peak.
Excellent flame resistance, non-flammable, they withstand most solvents.

600 volts RMS

Construction

1- CONDUCTOR

Stranded nickel plated copper,
Thin wrapped PTFE layer

2- INSULATION

Polyimide

3- OUTER JACKET

a) from 0.38 to 1.34 mm²:
extruded PTFE sheath (high abrasion resistance)

b) from 1.91 mm²:
composite glass fibre + PTFE + wrapped and sintered PTFE sheath.

Cross sections from 0.38 to 1.34 mm²

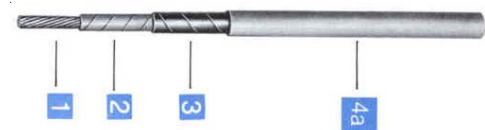

Cross sections from 1.91 mm²

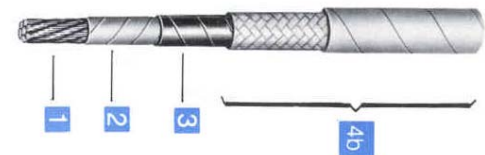

Technical requirements and control conditions

Air4524 Specification of September 1965 - Category 250/280°C,
NFL 52-125A French Draft Specification - Category C, of July 1978
- Standard cables.

Interchangeability

MIL-W-22759 D Specification - Index 8 A of June 1973.

Colour coding

According to AIR0107 (10/1961).

Standards

To AIR 4524, B.N.Aé, MIL-W-22759 D & B.M.S. 13-58
These cables are approved by the Air Ministry under letters :
N°42707 STA/EQ/E2 (03-12-68)
Registered at the B.N.Aé :
N° 6418 401

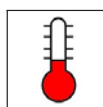

-50 °C to +250 °C



AIR 4524



Flexible



RoHS

2100 - Flexible cables for high ambient temperature

Nexans Reference		Gauge	CONDUCTOR		CORE			ELECTRICAL VALUES	
Type	Cross section		Construction	Nominal diameter	Overall diameter	Weight		D.C. Resistance at 20°C (maxi.)	Current rating
		AWG	n x Ø mm	mm	mm	nomi. g/m	maxi. g/m	Ω / km	A
2100	0.38	22	12 x 0.20	0.85	1.90 ± 0.10	8.6	9.3	54.50	7
2100	0.60	20	19 x 0.20	1.00	2.20 ± 0.10	12.1	12.4	34.40	11
2100	0.98	18	19 x 0.25	1.25	2.40 ± 0.10	15.8	17	22.00	16
2100	1.34	16	19 x 0.30	1.50	2.70 ± 0.10	19.6	20	15.30	22
2100	1.91	14	27 x 0.30	1.85	2.95 ± 0.10	26.1	27	10.80	32
2100	3.18	12	45 x 0.30	2.40	3.60 ± 0.15	40.8	16.5	6.50	41
2100	5.15	10	73 x 0.30	3.10	4.20 ± 0.20	60.4	65	3.40	55
2100	8.98	8	127 x 0.30	4.00	5.30 ± 0.20	102	108	2.30	75
2100	13.40	6	27 x 7 x 0.30	5.10	7.00 ± 0.30	158	160	1.60	100
2100	21.80	4	37 x 12 x 0.25	6.60	9.00 ± 0.30	237	245	0.97	135
2100	34.50	2	37 x 19 x 0.25	8.10	10.60 ± 0.30	391	396	0.61	181
2100	41.80	1	37 x 23 x 0.25	9.80	11.80 ± 0.30	460	470	0.50	211
2100	52.70	0	37 x 29 x 0.25	10.80	13.10 ± 0.30	580	600	0.40	245
2100	67.20	00	37 x 37 x 0.25	12.40	14.20 ± 0.30	736	750	0.31	283

The currents shown are valid for single wires in air.

Part 3
Hook-up wires
for wrapping

WRAPPING

Hook-up wires for wire-wrapping

Applications

These wires are designed for wire-wrapping connection consisting in winding a wire helically around a metallic terminal without any soldering operation.
Fast and robust connections.

350 volts

Construction

1- CONDUCTOR

solid silvered copper wires

2- INSULATION

polyvinyl chloride (PVC) or ethylene and tetrafluorethylene copolymer (E.T.F.E.) or polytetrafluorethylene (P.T.F.E.)



Wire-wrapping procedure

Method **A**: conductor only wrapped around pin.

Method **B**: conductor with insulation wrapped around pin (better elasticity of connection).

Standards

NF C 93-522

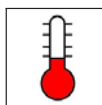

PVC
-40 °C to +85 °C
ETFE
-60 °C to +150 °C
PTFE
-90 °C to +200 °C



PVC
(NF C 32-070/C1)
ETFE
(NF C 32-070/C1)
PTFE
(NF C 32-070/C1)



Extra-flexible



RoHS

■ Hook-up wires for wire-wrapping

Reference NFC 93 522	Nexans Reference	CONDUCTOR			Insulation nature	Overall diameter		Average weight Kg/km
		Gauge AWG	Cross section mm ²	Construction n x Ø mm		mini.	maxi.	
						mm		
KW 01-30C1	WCP 30	30	0.05	1 x 0.254	PVC	0.48	0.58	0.73
KW 01-28C1	WCP 28	28	0.08	1 x 0.32	PVC	0.57	0.67	1.05
KW 01-26C1	WCP 26	26	0.12	1 x 0.40	PVC	0.69	0.79	1.65
KW 01-24C1	WCP 24	24	0.20	1 x 0.51	PVC	1.00	1.10	2.80
KW 02-30B1	WCZ 30	30	0.05	1 x 0.254	ETFE	0.48	0.58	0.79
KW 02-28B1	WCZ 28	28	0.08	1 x 0.32	ETFE	0.57	0.67	1.12
KW 02-26B1	WCZ 26	26	0.12	1 x 0.40	ETFE	0.69	0.79	1.85
KW 02-24B1	WCZ 24	24	0.20	1 x 0.51	ETFE	1.00	1.10	2.90
KW 03-30A2	WCT 30	30	0.05	1 x 0.254	PTFE	0.48	0.58	0.88
KW 03-28A2	WCT 28	28	0.08	1 x 0.32	PTFE	0.57	0.67	1.25
KW 03-26A2	WCT 26	26	0.12	1 x 0.40	PTFE	0.69	0.79	1.90
KW 03-24A2	WCT 24	24	0.20	1 x 0.51	PTFE	1.00	1.10	3.30

For connections on automatic machines, we manufacture these wires with smaller dimensional tolerances.
Please, consult us.

Part 4
Accessories

FITE

Tinned copper flat braids

■ Applications

Applications: mainly for connections of mobile contacts, shunts and earthing of mobile equipment (doors, chassis, etc...).

The very thin strands used to manufacture these braids make them extremely flexible and give them an excellent flex life.

Flat braids

■ Construction

Braids made up of tinned copper wires.

These braids are ribbon-like structures (only one ribbon) up to FITE 10.

They are flattened (crushed cylinder) for greater sizes.



■ Standards

NEXANS specification



Extra-flexible



RoHS

■ FITE - Tinned copper flat braids

Nexans Reference	Construction n x Ø mm	Cross section area mm ²	Approximate dimensions mm	Average weight Kg/km	Current rating A
FITE 01	26 x 0.12	0.29	2.0 x 0.3	3	3
FITE 02	26 x 0.15	0.46	3.0 x 0.4	4	6
FITE 03	26 x 0.20	0.81	4.0 x 0.6	8	9
FITE 04	39 x 0.20	1.22	4.5 x 0.6	12	12
FITE 05	78 x 0.20	2.45	7.0 x 0.7	25	25
FITE 06	104 x 0.20	3.26	8.0 x 1.0	32	32
FITE 07	130 x 0.15	2.30	6.5 x 0.7	22	21
FITE 08	195 x 0.15	3.44	8.0 x 1.0	35	32
FITE 09	260 x 0.15	4.60	9.0 x 1.0	45	38
FITE 10	390 x 0.15	6.90	11.0 x 1.5	70	50
FITE 11	736 x 0.15	13.00	16.0 x 2.0	130	80
FITE 12	352 x 0.20	11.10	15.0 x 2.0	113	70
FITE 13	384 x 0.25	18.80	21.0 x 2.5	198	116
FITE 14	480 x 0.25	23.50	22.0 x 2.5	235	144
FITE 15	960 x 0.20	30.20	25.0 x 3.0	300	160
FITE 16	800 x 0.20	25.10	20.0 x 2.5	250	150

TUBULAR BRAIDS

in tinned copper
without filler

■ Applications

Physical and electrical protection for cable bundles.

The diameter of these braids may vary thanks to their very high flexibility, thus facilitating the bundle introduction.

Tubular braids

■ Construction

Tubular braid made up of tinned copper wires.

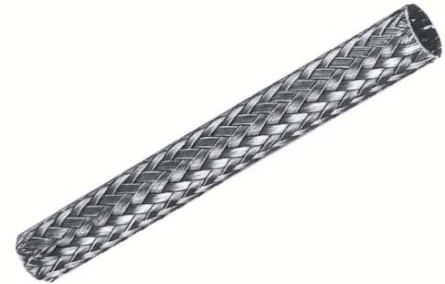

■ Standards

NEXANS specification



Extra-flexible



RoHS

■ Tubular braids in tinned copper without filler

Internal Ø nominal mm	Construction n x Ø mm	Cross section area mm ²	Increases overall diameter	Average weight Kg/km
4	112 x 0.20	3.5	0.8	35
6	144 x 0.20	4.5	0.8	45
8	192 x 0.20	6.0	0.8	60
10	192 x 0.25	9.4	1.0	94
12	224 x 0.25	11	1.0	110
15	256 x 0.25	12.6	1.0	135
19	320 x 0.25	15.7	1.0	165

TUBULAR BRAIDS

in tinned copper
with filler

■ Applications

Physical and electrical protection for cable bundles.

The central filler prevents any deformation of the braid and is withdrawn when introducing the bundles.

Tubular braids

■ Construction

Tubular braid made up of tinned copper wires around a central filler.

Nota : The cover factor is about 75 % ($K_r = 0,75$) or 80 % ($K_r = 0,80$) according to NF C 93521 § 1.7.5. French specification.



■ Standards

NEXANS specification



Extra-flexible



RoHS

■ Tubular braids in tinned copper with filler

Nexans Reference	Internal Ø mm	Overall Ø mm	Covering coefficient Kr	Average weight Kg/km	Nominal cross section mm²
52104	4	4.5	0.75	14.0	1.37
55304/1			0.80	15.0	
52 106	6	6.5	0.75	21.4	2.00
55 306/1			0.80	22.0	
52108	8	8.5	0.75	28.2	2.60
55308/1			0.80	29.0	
52110	10	10.5	0.75	35.1	3.40
55 310/1			0.80	36.0	
52112	12	12.5	0.75	42.0	4.00
55312/1			0.80	44.0	
52115	15	15.5	0.75	52.3	5.00
55 315/1			0.80	54.0	
55955/1	18	18.5	0.80	79.0	7.20
52120	20	20.8	0.75	105.0	9.60
55320/1			0.80	108.0	
59956/1	22	22.8	0.80	120.0	11.30
59957/1	25	26.0	0.80	182.0	17.60
59958/1	30	31.0	0.80	218.0	20.00

TUBULAR SUPERPOLYAMIDE BRAIDS

High temperature

■ Applications

Mechanical protection of cables without any faradization screen.
Very high toughness.
Very significant breaking load.
Very good abrasion resistance.
Lightweight in comparison with corresponding copper braid or steel braid.

Tubular braids

■ Construction

Tubular braid made up of superpolyamide strands.



■ Standards

NEXANS specification

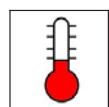

+135 °C max



Extra-flexible



RoHS

■ Tubular superpolyamide braids, high temperature

Internal Ø nominal mm	Construction n x Ø mm	Increases overall diameter mm	Average weight Kg/km
3	32 x 0.29	1.2	4.7
4	72 x 0.29	1.2	6.7
6	96 x 0.29	1.2	9.0
8	128 x 0.29	1.2	13.0
10	160 x 0.29	1.2	18.0
12	192 x 0.29	1.2	21.0
15	200 x 0.29	1.2	25.0
18	240 x 0.29	1.2	28.0
20	288 x 0.29	1.2	35.0
25	336 x 0.29	1.2	41.0
30	224 x 0.40	1.6	64.0
35	280 x 0.40	1.6	70
40	335 x 0.40	1.6	80.0

TUBES

Extruded PTFE

Applications

These flexible tubes are used for insulation and mechanical protection of cores. They are recommend for use at high ambient temperatures up to 300°C at peak.

Very good resistance to fluids (oil, skydrol, petrol, isopropyl alcohol, kerosene) and most solvents. Mould and Fungus Resistant. They are waterproof and fire retardant.

Tubes





Construction

Tube in extruded polytetrafluorethylene (P.T.F.E.)

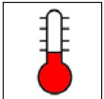

Standards

NEXANS specification

 <p>- 90°C to +250°C</p>	 <p>Fire retardant (NF C 32-070/C1)</p>	 <p>Ultra-flexible</p>	 <p>RoHS</p>
---	--	--	---

PTFE tubes

Gauge AWG	Internal Ø			Radial thickness (mm)	Tolerance +/- (mm)	Nominal external Ø (mm)	Average weight (Kg/km)
	minimum (mm)	nominal (mm)	maximum (mm)				
30	0.25	0.30	0.38	0.23	0.05	0.76	0.9
28	0.33	0.38	0.48	0.23	0.05	0.84	1.0
26	0.41	0.46	0.56	0.23	0.05	0.91	1.1
24	0.51	0.56	0.69	0.25	0.08	1.07	1.5
22	0.64	0.77	0.81	0.25	0.08	1.28	1.7
21	0.74	0.81	0.91	0.25	0.08	1.32	1.9
20	0.81	0.86	1.01	0.31	0.08	1.47	2.5
19	0.91	0.97	1.11	0.31	0.08	1.58	2.7
18	1.02	1.07	1.24	0.31	0.08	1.68	2.9
17	1.14	1.19	1.37	0.31	0.08	1.80	3.1
16	1.30	1.35	1.55	0.31	0.08	1.96	3.5
15	1.45	1.50	1.70	0.31	0.08	2.11	3.8
14	1.63	1.68	1.88	0.31	0.08	2.29	4.2
13	1.83	1.93	2.08	0.31	0.08	2.54	4.8
12	2.06	2.16	2.31	0.31	0.08	2.77	5.2
11	2.31	2.41	2.56	0.31	0.08	3.02	5.7
10	2.59	2.70	2.84	0.31	0.08	3.31	6.4
9	2.90	3.00	3.15	0.38	0.08	3.76	8.9
8	3.28	3.38	3.58	0.38	0.08	4.14	9.7
7	3.66	3.76	4.01	0.38	0.08	4.52	11.0
6	4.11	4.21	4.52	0.38	0.08	4.97	12.1
5	4.62	4.72	5.03	0.38	0.08	5.48	13.4

Equivalence table of U.S. wire gauges for diameters and cross section areas

GAUGES		DIAMETERS*		CROSS SECTION AREAS		D.C. RESISTANCES AT 20°C	
AWG	Mils	mm	Circ. mils	sq. mm (mm ²)	Ohm / kFt	Ohm / Km	
44	2,0	0,050	4,00	0,0020	2590,0	8498,00	
43	2,2	0,055	4,84	0,0025	2140,0	7021,00	
42	2,5	0,063	6,25	0,0032	1660,0	5446,00	
41	2,8	0,071	7,84	0,0039	1320,0	4330,00	
40	3,1	0,079	9,61	0,0049	1080,0	3540,00	
39	3,5	0,089	12,30	0,0062	847,0	2780,00	
38	4,0	0,102	16,00	0,0081	648,0	2130,00	
37	4,5	0,114	20,30	0,0103	512,0	1680,00	
36	5,0	0,127	25,00	0,0127	415,0	1360,00	
35	5,6	0,142	31,40	0,0159	331,0	1080,00	
34	6,3	0,160	39,70	0,0201	261,0	587,00	
33	7,1	0,180	50,40	0,0255	206,0	675,00	
32	8,0	0,203	64,00	0,0324	162,0	532,00	
31	8,9	0,226	79,20	0,0401	131,0	430,00	
30	10,0	0,254	100,00	0,0507	104,0	340,00	
29	11,3	0,287	128,00	0,0649	81,20	266,00	
28	12,6	0,320	159,00	0,0806	65,30	214,00	
27	14,2	0,361	202,00	0,1020	51,40	169,00	
26	15,9	0,404	253,00	0,1280	41,00	135,00	
25	17,9	0,455	320,00	0,1620	32,40	106,00	
24	20,1	0,511	404,00	0,2050	25,70	84,20	
23	22,6	0,574	511,00	0,2590	20,30	66,60	
22	25,3	0,643	640,00	0,3240	16,20	53,20	
21	28,5	0,724	812,00	0,4110	12,80	41,90	
20	32,0	0,813	1.020	0,5190	10,10	33,20	
19	35,9	0,912	1.290	0,6530	8,05	26,40	
18	40,3	1,020	1.620	0,8230	6,39	21,00	
17	45,3	1,150	2.050	1,0400	5,05	16,60	
16	50,8	1,290	2.580	1,3100	4,02	13,20	
15	57,1	1,450	3.260	1,6500	3,18	10,40	
14	64,1	1,630	4.110	2,0800	2,52	8,28	
13	72,0	1,830	5.180	2,6300	2,00	6,56	
12	80,8	2,050	6.530	3,3100	1,59	5,21	
11	90,7	2,300	8.230	4,1700	1,26	4,14	
10	101,9	2,588	10.380	5,2600	0,9988	3,277	
9	114,4	2,906	13.090	6,6300	0,7925	2,600	
8	128,5	3,264	16.510	8,3700	0,6281	2,061	
7	144,3	3,655	28.820	10,5500	0,4981	1,634	
6	162,0	4,115	26.240	13,3000	0,3952	1,296	
5	181,9	4,620	33.090	16,7700	0,3134	1,028	
4	204,3	5,189	41.740	21,1500	0,2485	0,8152	
3	229,4	5,827	52.620	26,6700	0,1971	0,6466	
2	257,6	6,543	66.360	33,6200	0,1563	0,5128	
1	289,3	7,348	83.690	42,4100	0,1239	0,4065	
1/0	324,9	8,252	105.600	53,4900	0,09825	0,3223	
2/0	364,8	9,266	133.100	67,4300	0,07793	0,2557	
3/0	409,6	10,400	167.800	85,0100	0,06182	0,2028	
4/0	460,0	11,680	211.600	107,2200	0,04901	0,1608	

*Nominal diameter of solid bare copper wire

This catalogue shows a general description of products whose characteristics are not contractual in any way whatsoever. Nexans reserves the right to change specifications without prior notice.
Passing on or copying of the document, use or communicate of its content is not permitted without prior written authorization.



Global expert in cables and cabling systems

Nexans is the worldwide leader in the cable industry. The Group brings an extensive range of advanced copper and optical fiber cable solutions to the infrastructure, industry and building markets. Nexans cables and cabling systems can be found in every area of people's lives, from telecommunications and energy networks, to aeronautics, aerospace, automobile, railways, building, petrochemical, medical applications, etc. With an industrial presence in 29 countries and commercial activities in 65 countries, Nexans employs 20,000 people and had sales in 2005 of euros 5.4 billion. Nexans is listed on the Paris stock exchange.



140, rue Eugène Delacroix - BP1 - 91211 Draveil Cedex France

Tel : + 33 (0)1 69 83 78 00 - Fax : +33 (0)1 69 42 05 70

Electronic.products@nexans.com - www.nexans.com