

	Page
RADIALL company profile	4-5
MCX Series	
General	6
Finder guide	7
Interface	8
Characteristics	9
Straight plugs	10
Right angle plugs	11
Straight jacks	12
Straight bulkhead jacks	13
Straight female panel receptacles	14
Right angle female panel receptacles	14
Straight female PCB receptacles	15
Straight male PCB receptacle	15
Right angle female PCB receptacles	16
Demonstration boards	16
In series adaptors	17
Between series adaptors	17
PCB cable terminals	
Finder guide	18
Straight PCB cable terminals	19
Right angle PCB cable terminals	20
Tooling	21
Panel drillings	22
Mountings	23-36
Cable dimensions	37
Index of P/N	38

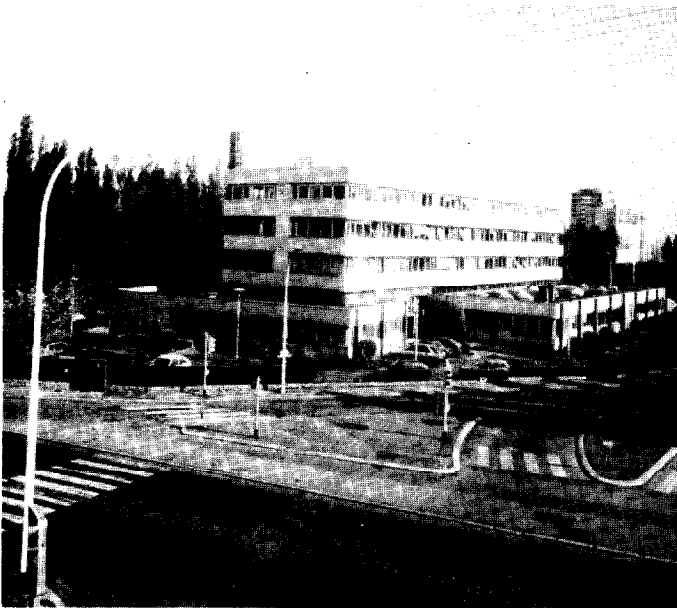
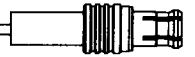

Head Office – Rosny sous Bois

RESEARCH & DEVELOPMENT

The ever increasing sophistication of microwave communication systems is continually requiring components to meet a higher level of performance. **RADIALL's** research and development groups understand these needs and are committed to searching for product solutions that will be needed in the future. They also are providing continued improvements to our already extensive lines of high performance products. All our engineer teams are equipped with state of the art equipment and facilities, in an effort to provide the best solutions to our customers.



CAD workstation

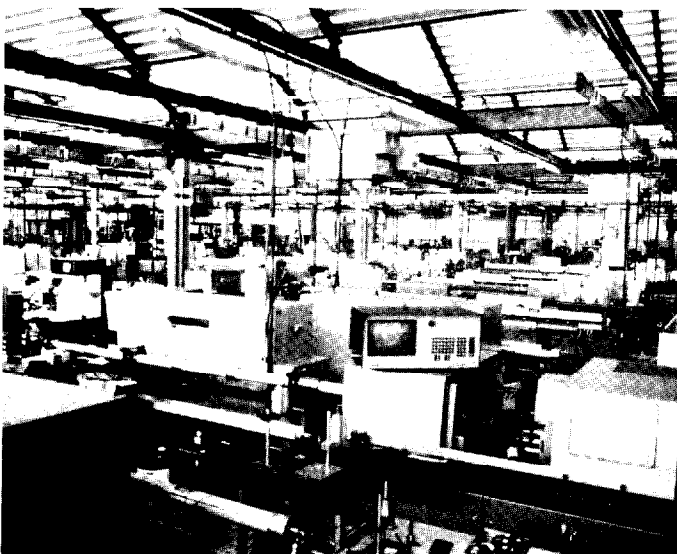

Screw-machining shop

MANUFACTURING

RADIALL knows that the quality of the connectors components is directly related to the mechanical precision of the machining process, along with good quality procedures. In an effort to continually meet the highest quality standards, all our production plants are equipped with the latest state of the art production equipment. **RADIALL's** manufacturing process maintains strict control of all procedures and incorporates all tooling, machining, surface treatment and assembly operations into the manufacturing process of each production group.

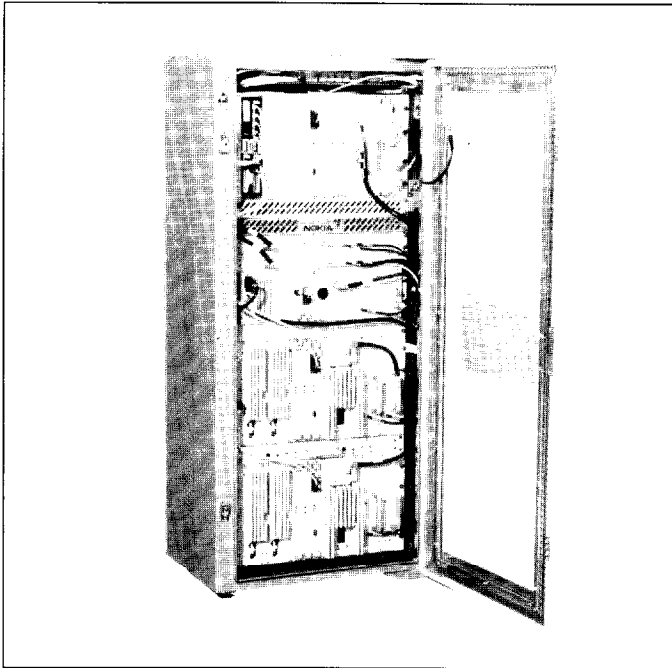
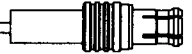

Base station of cellular network

HIGH RELIABILITY

Reliability of inter-connection systems is of the utmost importance in telecommunications applications. This industry need has led **RADIALL** to link high performance design, manufacturing and quality control. This has given the company the capability to produce connectors that will operate in the most stringent environments. The wide range of our product offering allows us to propose the best complete solution for your exact need.

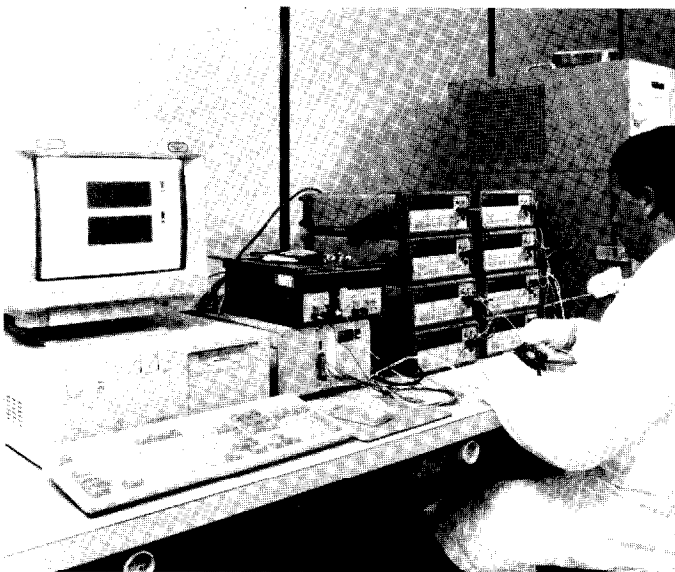

Microwave test device

QUALITY ASSURANCE

RADIALL, as a TQM company, continually searches for improvements to the quality process. We operate a Quality Assurance Program that has been developed in accordance with the national and **CECC** agencies (equivalent to **MIL-I-45208** and **MIL-C-45662** standards). This program has enabled us to achieve QPL approval on several of our connector series. **RADIALL's** Quality Assurance Program operates at all levels of manufacturing from the initial raw incoming material to the final testing procedures just prior to shipping. All test equipment is part of the quality process and is continually inspected on a regular scheduled basis. All production plants in Europe are **AQA P4-NATO** certified.



Certificate of Approval

Awarded to

RADIALL
DIVISION CONNECTEURS COAXIAUX
ROUSNY-SOUS-BUIS - VUREPPE - VOIRON - FRANCE

Bureau Veritas Quality International certify that the Quality Management System of the above supplier has been assessed and found to be in accordance with the requirements of the quality standards detailed below

QUALITY STANDARDS

BS EN ISO 9001 : 1994

SCOPE OF SUPPLY

DESIGN, DEVELOPMENT, PRODUCTION AND SALE OF RADIO FREQUENCY COAXIAL CONNECTORS AND LEADS.

CONCEPTION, DEVELOPPEMENT, PRODUCTION ET COMMERCIALISATION DE CONNECTEURS ET CORDONS COAXIAUX HAUTES FREQUENCES

FORSCHUNG, ENTWICKLUNG, PRODUKTION UND VERTRIEB VON HF-STECKERVERBINDERN UND -KABELN.

Original approval date: 6th March, 1994

Subject to the continued satisfactory operation of the supplier's Quality Management System, this Certificate is valid for a period of three years from:

6th March, 1994

Date 11th December, 1995

C. Ashley
For Bureau Veritas Quality International

Certificate No: 6814

SH07A

ISO 9001 ACCREDITATION

This certificate is witness to **RADIALL's** achievement and commitment to the Total Quality Process. **RADIALL** has always been, since its inception, a company committed to being a Total Quality supplier. Quality is our way of life at **RADIALL**.

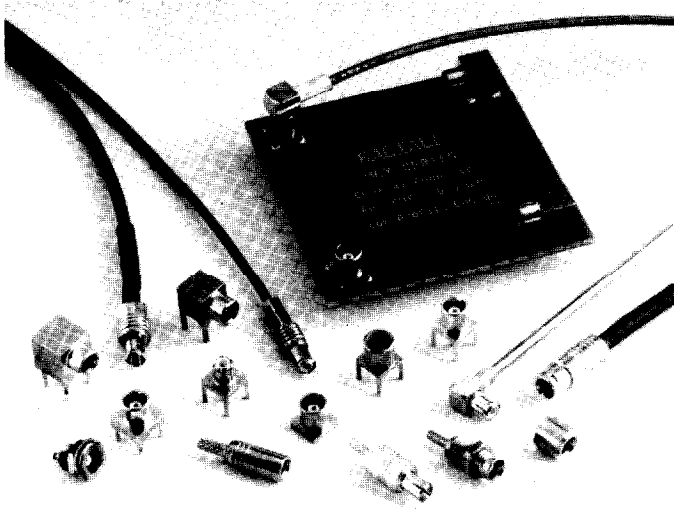

50 Ω

75 Ω

DC - 6 GHz

INTRODUCTION

- Microminiature coaxial connectors
- "Push-pull" snap-on mating
- Complies with specification CECC 22220
- CEI standard 1169-36

APPLICATIONS

50 Ω models :

- Wireless communications
- Civil and military radio-telecommunication equipment
- Videocommunication

75 Ω models :

- Videocommunication
- Television broad casting

The **MCX series** utilises the SMB series electrical line and features a particularly simple, compact and robust interface.

The MCX series is 30 % smaller than the SMB.

The **MCX series** helps to **miniaturize equipments**. It lowers wiring connection costs through its full crimp and solder-crimp versions as the center contact of the straight models can be either crimped or soldered. It optimizes PCB layouts with its range of models for PCBs including surface mount and press-fit receptacles.

This catalogue also includes the whole range of PCB solder coaxial cable terminals (see pages 18/20).

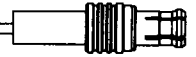

CABLE CONNECTOR (R113 = 50 Ω - R213 = 75 Ω)

model	straight plug		bulkhead straight plug	right-angle plug		straight jack		straight snap jack	bulkhead straight jack		
	full crimp type	solder type		crimp type	solder type	full crimp type	solder type		full crimp type	solder type	full crimp type
2/50/S (RG 178)	R113 081 xxx (page 10)			R113 181 xxx (page 11)	R113 161 xxx (page 11)	R113 236 xxx (page 12)			R113 306 xxx (page 13)		
2.6/50/S (RG 316)	R113 082 xxx (page 10)		R113 030 005 (page 10)	R113 182 xxx (page 11)	R113 161 xxx (page 11)	R113 240 xxx (page 12)			R113 310 xxx (page 13)		R113 312 000 (page 13)
(2.6/75/S) (RG 179)	R213 082 007 (page 10)			R213 182 007 (page 11)				R213 238 007 (page 12)			
2.6/50/D (RD 316)	R113 083 xxx (page 10)			R113 183 xxx (page 11)		R113 241 xxx (page 12)			R113 311 xxx (page 13)		
2.6/75/D	R213 083 007 (page 10)			R213 183 007 (page 11)				R213 239 007 (page 12)			
.047		R113 051 xxx (page 10)			R113 151 xxx (page 11)		R113 221 xxx (page 12)			R113 301 xxx (page 13)	
.085 (RG 405)		R113 053 xxx (page 10)			R113 153 xxx R113 161 xxx (page 11)		R113 223 xxx (page 12)			R113 303 xxx (page 13)	
.141 (RG 402)					R113 155 000 (page 11)						

RECEPTACLE (R113 = 50 Ω - R213 = 75 Ω)

model	PCB receptacle			panel straight receptacle			panel right-angle receptacle
	female straight	right-angle	male straight	bulkhead front mount	rear mount	press-fit front mount	bulkhead front mount
solder pins standard space (square flange 6mm)	R113 426 xxx R213 426 000 (page 15)	R113 665 xxx R213 665 000 (page 16)	R113 425 000 (page 15)				
solder pins (reduced space)	R113 427 xxx (page 15)	R113 666 xxx (page 16)					
surface mount (on board)	R113 424 xxx R213 424 800 (page 15)	R113 664 xxx R213 664 800 (page 16)					
surface mount (edge card)	R113 423 000 (page 15)						
press-fit pins (square flange 7mm)	R113 416 xxx (page 15)	R113 661 xxx (page 16)					
solder contact (cylindrical tab)				R113 553 xxx (page 14)		R113 402 220 (page 14)	R113 670 xxx (page 14)
solder contact (cylindrical)					R113 556 500 (page 14)		
solder pins (round flange)					R113 554 020 (page 14)		

IN-SERIES ADAPTOR

model	straight
Female / Female	R113 704 xxx (page 16)

ATTENTION ! This guide is intended as an information and does not include all MCX series P/N

MCX

INTERFACE

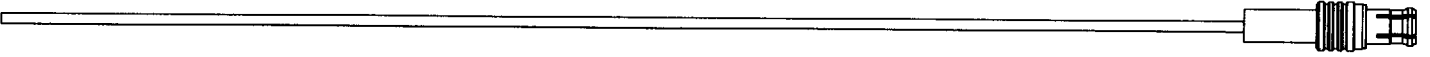

PLUG

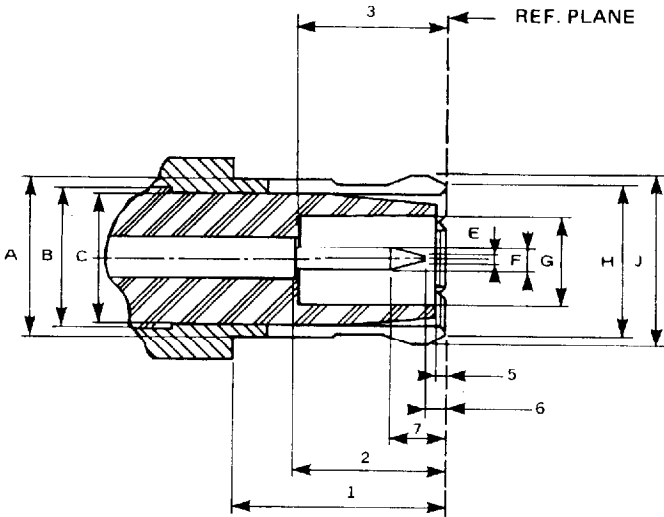

JACK

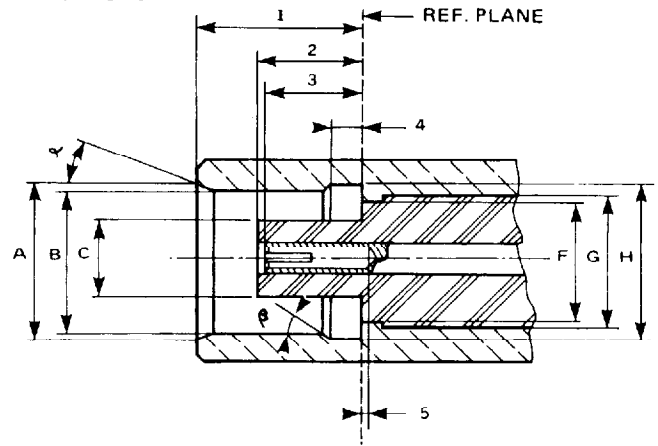

PLUG

ITEM	mm		Inch	
	mini	maxi	mini	maxi
1	4,15	—	.163	
2	2,80	3,20	.110	.126
3	2,80		.110	
5	0,00	0,30	.000	.012
6	0,15		.006	
7		1,20		.047
A		3,40		.134
B	3,05 NOM.		.120 NOM.	
C		3,00		.118
F		0,25		.010
F	0,48	0,53	.019	.021
G	2,00		.079	
H		3,60		.142
J		3,80		.150

JACK

ITEM	mm		Inch	
	mini	maxi	mini	maxi
1	4,00	4,12	.157	.162
2	2,60	2,80	.102	.110
3	2,30	2,80	.090	.110
4	0,75	0,85	.029	.033
5	0,00		.000	
α	18 °	22 °	18 °	22 °
β	43 °	47 °	43 °	47 °
A	3,80		.150	
B	3,42	3,48	.135	.137
C		1,98		.078
F		3,00		.118
G	3,05 NOM.		3,05 NOM.	
H	3,60	3,75	.142	.148

Note : All dimensions in the following pages of this catalogue are given in inches (mm).

* statistics cotation : $.0539 \pm .0055$ (.0594 max)/(1.37 \pm 0.14)(1.51 max)

- 1) Coupling nut against on datum 1
- 2) Coupling nut against on datum 2

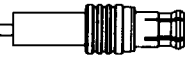

REQUIREMENT	GENERAL SPECIFICATIONS		
-------------	------------------------	--	--

ELECTRICAL

Impedance	50 Ω and 75 Ω		
Frequency range	DC - 6 GHz		
Typical V.S.W.R.	1 GHz	2.5 GHz	6 GHz
<i>Straight styles</i>			
.085	1.04	1.08	1.13
2.6/50/S	1.06	1.09	1.12
<i>Right angle styles</i>			
.085	1.03	1.06	1.10
2.6/50/S	1.04	1.07	1.10
Insulation resistance	1000 M Ω		
Contact resistance (m Ω)	Initial	After environment	
Center contact	≤ 5	≤ 15	
Outer contact	≤ 2.5	≤ 7.5	
Voltage rating (V.R.M.S)	At sea level	At 70.000 Ft	
Cable RG 196/U -.047 - RG 188/U	170 V rms max	45 V rms max	
.102(2.6) double screen	335 V rms max	85 V rms max	
RG 405/U -.085	250 V rms max	65 V rms max	
Dielectric withstanding voltage	at sea level	at 70.000 Ft	
Cable RG 196/U -.047 - RG 188/U	500 V rms max	100 V rms max	
.102(2.6) double screen	750 V rms max	100 V rms max	
RG 405/U -.085	750 V rms max	100 V rms max	

MECHANICAL

Mechanical endurance	500 matings
Engagement and separation force	
Engagement	≤ 14.2 lbs - 63 N max
Separation	≥ 1.8 Lbs - 8N ≤ 4.5 lbs 20 N
Cable retention force	
RG 196/U-	≥ 7.2 lbs - 32 N
RG 188/U-	≥ 11.9 lbs - 53 N
K 02252 d .102 (2.6/50 Ω) double screen	≥ 24.1 lbs - 107 N
.047	≥ 9.7 lbs - 43 N
RG 405/U-.085	≥ 34.9 lbs - 155 N
Contact captivation	Axial force 2.25 Lbs 10 N

ENVIRONMENTAL

Operating temperature	-55°C +155°C	
Temperature cycling	CECC 22220 paragraph 4-6-5	
Thermal shock	CECC 22220 paragraph 4-6-7	MIL STD 202 - method 107 condition C
High temperature test	CECC 22220 paragraph 4-7-2	MIL STD 202 - method 108A condition D
Corrosion (salt spray)	CECC 22220 paragraph 4-6-10	MIL STD 202 - method 101 condition B
Vibration	CECC 22220 paragraph 4-6-3	MIL STD 202 - method 204 condition D

MATERIALS

Bodies and male contacts	Brass
Interface and female center contacts	Beryllium copper
Ferrules	Brass
Insulators	PTFE

PLATING

Bodies	Gold Nickel BBR (non magnetic) Tin lead
Center contacts	Gold

STRAIGHT PLUGS, FULL CRIMP TYPE, FOR FLEXIBLE CABLE

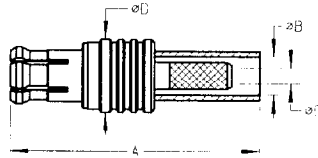
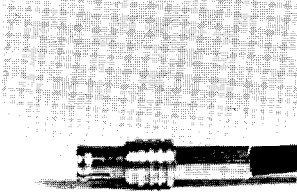

Fig. 1

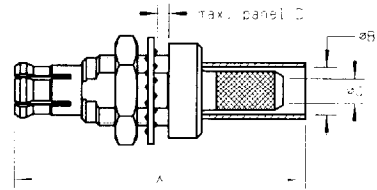
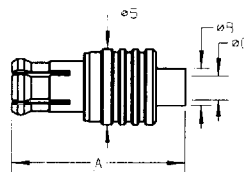

Fig. 2

cable group	part number	fig.	imp. (Ω)	dimensions (mm)				captive center contact	mounting	panel	finish
				A	B	C	D				
2 /50/ S	R113 081 000	1	50	16.3	2.55	1.1	5	no	M 01		Gold
2 /50/ S	R113 081 020	1	50	16.3	2.55	1.1	5	no	M 01		Nickel
2.6/50/ S	R113 082 000	1	50	16.3	2.95	1.65	5	yes	M 01		Gold
2.6/50/ S	R113 082 020	1	50	16.3	2.95	1.65	5	yes	M 01		Nickel
2.6/50/ S	R113 030 005●	2	50	21.55	3.25	1.72	2.5	yes	M 01	P 02	Nickel
2.6/50/ D	R113 083 000	1	50	16.3	3.25	1.65	5	yes	M 01		Gold
2.6/50/ D	R113 083 020	1	50	16.3	3.25	1.65	5	yes	M 01		Nickel
2.6/75/ S	R213 082 007	1	75	18.2	2.95	1.7	5.8	yes	M 01		BBR
2.6/75/ D	R213 083 007	1	75	18.3	3.25	1.7	5.8	yes	M 01		BBR

STRAIGHT PLUGS, SOLDER TYPE, FOR SEMI-RIGID CABLE



cable group	part number	imp. (Ω)	dimensions (mm)			captive center contact	mounting	finish
			A	B	C			
.047	R113 051 000●	50	11.3	2	1.3	no	M 04	Gold
.047	R113 051 020●	50	11.3	2	1.3	no	M 04	BBR
.085	R113 053 000	50	11.3	3	2.25	no	M 04	Gold
.085	R113 053 020●	50	11.3	3	2.25	no	M 04	BBR

● Upon request.

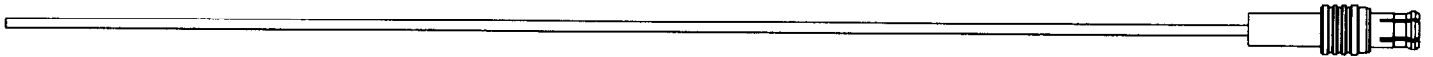

RIGHT ANGLE PLUGS, CRIMP TYPE, FOR FLEXIBLE CABLE (captive center contact)

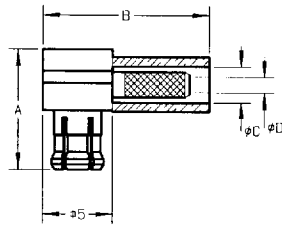
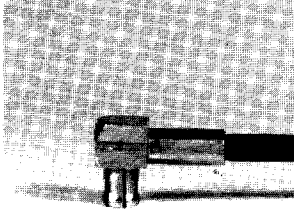

Fig. 1

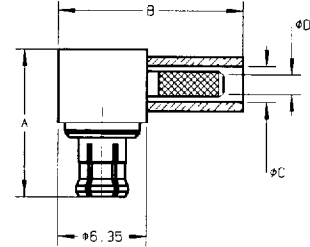
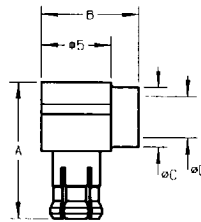

Fig. 2

cable group	part number	fig.	imp. (Ω)	dimensions (mm)				mounting	finish
				A	B	C	D		
2 /50/ S	R113 181 000	1	50	8.6	11.9	2.55	1.1	M 05	Gold
2 /50/ S	R113 181 020	1	50	8.6	11.9	2.55	1.1	M 05	Nickel
2.6/50/ S	R113 182 000	1	50	8.6	11.9	2.95	1.65	M 05	Gold
2.6/50/ S	R113 182 020	1	50	8.6	11.9	2.95	1.65	M 05	Nickel
2.6/50/ D	R113 183 000	1	50	8.6	11.9	3.25	1.65	M 05	Gold
2.6/50/ D	R113 183 020	1	50	8.6	11.9	3.25	1.65	M 05	Nickel
2.6/75/ S	R213 182 007	2	75	10.6	13.3	2.95	1.7	M 05	BBR
2.6/75/ S	R213 183 007	2	75	10.6	13.3	3.25	1.7	M 05	BBR

RIGHT ANGLE PLUGS, SOLDER TYPE, FOR SEMI-RIGID CABLE (AND FLEXIBLE CABLE) (captive center contact)



cable group	part number	imp. (Ω)	dimensions (mm)				mounting	finish
			A	B	C	D		
.047	R113 151 000	50	8.5	7	2	1.3	M 03	Gold
.047	R113 151 020●	50	8.5	7	2	1.3	M 03	BBR
.085	R113 153 000	50	8.5	7	3	2.25	M 03	Gold
.085	R113 153 020●	50	8.5	7	3	2.25	M 03	BBR
.141	R113 155 000●	50	9.3	7	4.35	3.05	M 03	Gold
2+2.6/50/S+.085	R113 161 000	50	7.9	8	3	2.35	M 02	Gold
2+2.6/50/S+.085	R113 161 020	50	7.9	8	3	2.35	M 02	BBR

● Upon request.

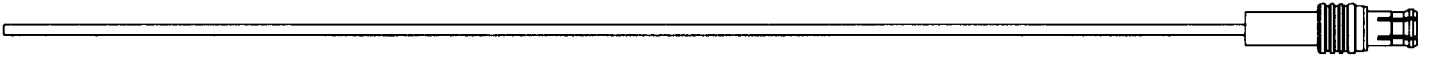

STRAIGHT JACKS, FULL CRIMP TYPE, FOR FLEXIBLE CABLE

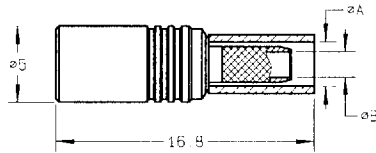

Fig. 1

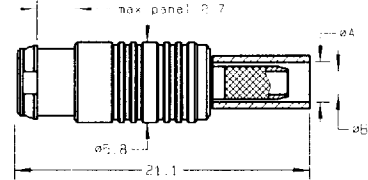
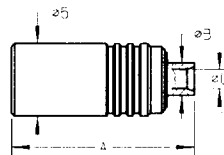

Fig. 2

cable group	part number	fig.	imp. (Ω)	dimensions (mm)		captive center contact	panel	mounting	finish	note
				A	B					
2 /50/ S	R113 236 000	1	50	2.55	1.1	no		M 01	Gold	
2 /50/ S	R113 236 020	1	50	2.55	1.1	no		M 01	Nickel	
2.6/50/ S	R113 240 000	1	50	2.95	1.65	yes		M 01	Gold	
2.6/50/ S	R113 240 020●	1	50	2.95	1.65	yes		M 01	Nickel	
2.6/50/ D	R113 241 000●	1	50	3.25	1.65	yes		M 01	Gold	
2.6/50/ D	R113 241 020●	1	50	3.25	1.65	yes		M 01	Nickel	
2.6/75/ S	R213 238 007	2	75	2.95	1.7	yes	P 01	M 01	BBR	Snap mount
2.6/75/ D	R213 239 007	2	75	3.25	1.7	yes	P 01	M 01	BBR	Snap mount

STRAIGHT JACKS, SOLDER TYPE, FOR SEMI-RIGID CABLE



cable group	part number	imp. (Ω)	dimensions (mm)			captive center contact	mounting	finish
			A	B	C			
.047	R113 221 000●	50	12.3	2	1.3	no	M 04	Gold
.047	R113 221 020●	50	12.3	2	1.3	no	M 04	BBR
.085	R113 223 000●	50	12.3	3	2.25	no	M 04	Gold
.085	R113 223 020●	50	12.3	3	2.25	no	M 04	BBR

● Upon request.

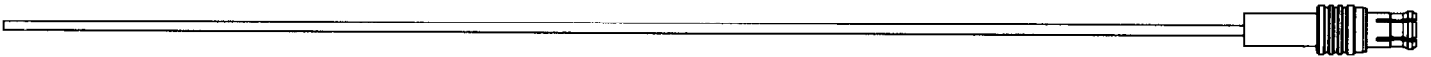

STRAIGHT BULKHEAD JACKS, FULL CRIMP TYPE, FOR FLEXIBLE CABLE

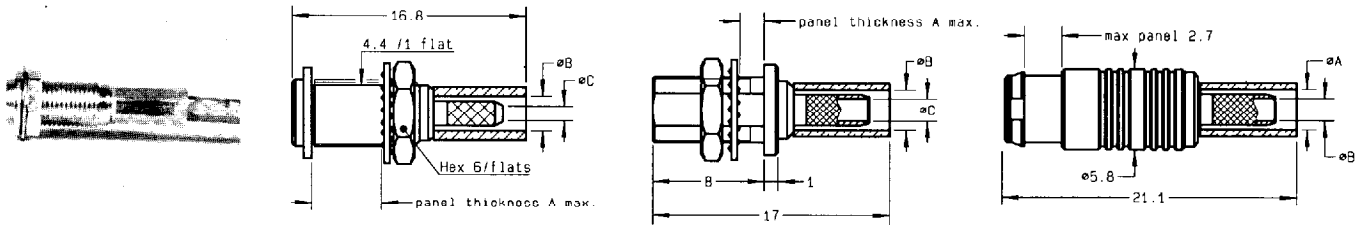

Fig. 1

Fig. 2

Fig. 3

cable group	part number	fig.	imp. (Ω)	dimensions (mm)			captive center contact	mounting	panel	finish	note
				A	B	C					
2 /50/ S	R113 306 000	1	50	5	2.55	1.1	no	M 01	P 02	Gold	
2 /50/ S	R113 306 020●	1	50	5	2.55	1.1	no	M 01	P 02	Nickel	
2.6/50/ S	R113 310 000	1	50	5	2.95	1.65	yes	M 01	P 02	Gold	
2.6/50/ S	R113 310 020●	1	50	5	2.95	1.65	yes	M 01	P 02	Nickel	
2.6/50/ S	R113 312 000●	2	50	5	2.95	1.65	yes	M 01	P 02	Gold	Rear mount
2.6/50/ D	R113 311 000●	1	50	5	3.25	1.65	yes	M 01	P 02	Gold	
2.6/50/ D	R113 311 020●	1	50	5	3.25	1.65	yes	M 01	P 02	Nickel	
2.6/75/ S	R213 238 007	3	75	2.95	1.7		yes	M 01	P 01	BBR	Snap mount
2.6/75/ D	R213 239 007	3	75	3.25	1.7		yes	M 01	P 01	BBR	Snap mount

STRAIGHT BULKHEAD JACKS, SOLDER TYPE, FOR SEMI-RIGID CABLE



cable group	part number	imp. (Ω)	dimensions (mm)			captive center contact	mounting	panel	finish
			A	B	C				
.047	R113 301 000●	50	5	2	1.3	no	M 04	P 02	Gold
.047	R113 301 020●	50	2.6	2	1.3	no	M 04	P 02	BBR
.085	R113 303 000●	50	2.6	3	2.25	no	M 04	P 02	Gold
.085	R113 303 020●	50	2.6	3	2.25	no	M 04	P 02	BBR

● Upon request.



STRAIGHT FEMALE PANEL RECEPTACLES (captive center contact)

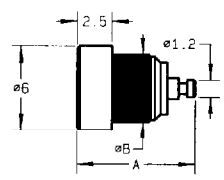
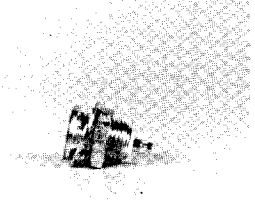

Fig. 1

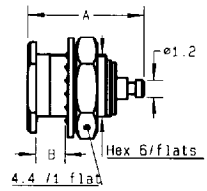

Fig. 2

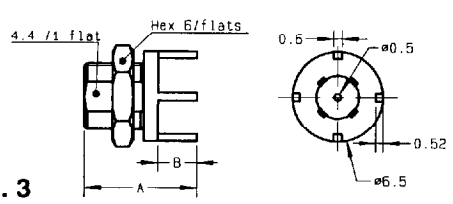

Fig. 3

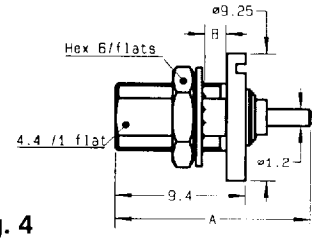
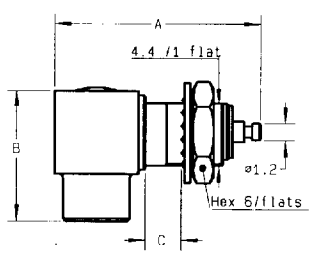
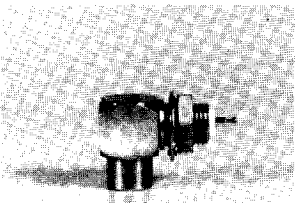

Fig. 4

part number	fig.	imp. (Ω)	dimensions (mm)		panel	finish	note
			A	B			
R113 402 220●	1	50	8.7	4.8	P 03	Nickel	Press-in mount
R113 553 000	2	50	8.65	2.5	P 02	Gold	Recessed front mount
R113 553 020	2	50	8.65	2.5	P 02	Nickel	Recessed front mount
R113 554 020●	3	50	8.1	2.8	P 04	Nickel	Panel mount + PCB
R113 556 500●	4	50	14	5	P 02	Gold	Rear mount

RIGHT ANGLE FEMALE PANEL RECEPTACLES (captive center contact)



part number	imp. (Ω)	dimensions (mm)			panel	finish
		A	B	C		
R113 670 000●	50	14.1	9.4	2.5	P 02	Gold
R113 670 020●	50	14.1	9.4	2.5	P 02	Nickel

● Upon request.

STRAIGHT FEMALE PCB RECEPTACLES (captive center contact)

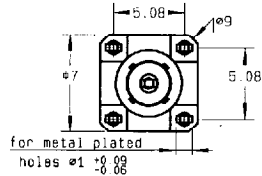

Fig. 1

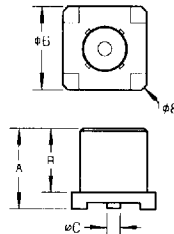

Fig. 3

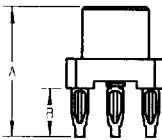

Fig. 2

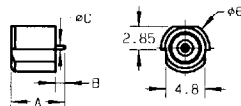

Fig. 4

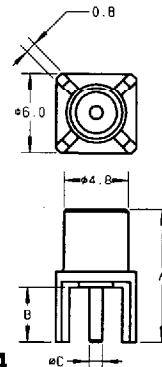

Fig. 5

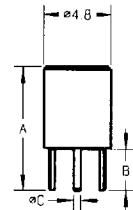
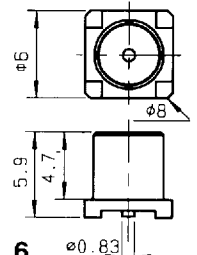
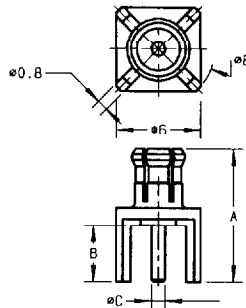

Fig. 6



part number	fig.	imp. (Ω)	dimensions (mm)			mounting	PCB	finish	note
			A	B	C				
R113 416 000	1	50	9.45	3.5		M 06	P 04	Gold	Press-Fit PCB mount
R113 416 020	1	50	9.45	3.5		M 06	P 04	Nickel	Press-Fit PCB mount
R113 423 000	2	50	6.9	1.1	0.5	M12		Gold	SMT / Edge-card
R113 424 000	3	50	5.9	4.7	0.96	M12		Gold	SMT
R113 424 010	3	50	5.9	4.7	0.96	M12		Gold	SMT / reel 100 pieces
R113 424 020	3	50	5.9	4.7	0.96	M12		Gold	SMT / reel 500 pieces
R113 426 000	4	50	10	4	0.98		P 05	Gold	
R113 426 010●	4	50	10	3.6	0.98		P 05	Gold	Short pins
R113 426 020	4	50	10	4	0.98		P 05	BBR	
R113 426 120●	4	50	10	4	0.98		P 05	Tin lead	
R113 427 000	5	50	9	3	0.5		P 06	Gold	Space saving on PCB
R113 427 020	5	50	9	3	0.5		P 06	BBR	Space saving on PCB
R213 426 000●	4	75	10	4.1	0.71		P 05	Gold	
R213 424 800	6	75				M12			SMT / reel 100 pieces

STRAIGHT MALE PCB RECEPTACLE (captive center contact)



part number	imp. (Ω)	dimensions (mm)			PCB	finish
		A	B	C		
R113 425 000●	50	9.5	4	0.96	P 05	Gold

● Upon request.

RIGHT ANGLE FEMALE PCB RECEPTACLES (captive center contact)

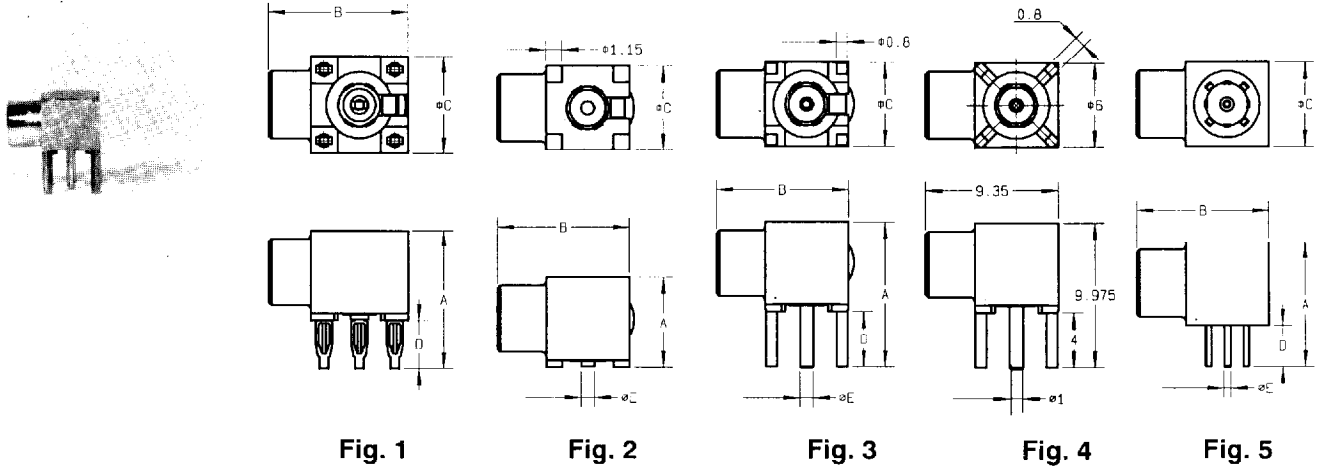

Fig. 1

Fig. 2

Fig. 3

Fig. 4

Fig. 5

part number	fig.	imp. (Ω)	dimensions (mm)					mounting	PCB	finish	note
			A	B	C	D	E				
R113 661 000	1	50	10	10	7	3.5		M 06	P 04	Gold	Press-fit PCB mount
R113 661 020	1	50	10	10	7	3.5		M 06	P 04	Nickel	Press-fit PCB mount
R113 661 027	1	50	10	10	7	3.5		M 06	P 04	BBR	Press-fit PCB mount
R113 664 000	2	50	6.5	9.5	6		0.98	M 12		Gold	SMT
R113 664 100	2	50	6.5	9.5	6		0.98	M 12		Gold	SMT / reel 100 pieces
R113 664 120	2	50	6.5	9.5	6		0.98	M 12		Gold	SMT / reel 500 pieces
R113 665 000	3	50	10.5	9.5	6	4	0.98		P 05	Gold	
R113 665 010●	4	50							P 05	Gold	
R113 665 020	3	50	10.5	9.5	6	4	0.98		P 05	BBR	
R113 665 037	3	50	9.5	9.5	6	3	0.98		P 05	BBR	Packaging : 100 pieces
R113 665 110●	3	50	11.5	9.5	6	2.5	0.98		P 05	Gold	
R113 665 127●	3	50	10.5	9.5	6	4	0.98		P 05	BBR+tin lead	Packaging : 100 pieces
R113 665 137●	3	50	9.5	9.5	6	3	0.98		P 05	BBR+tin lead	Packaging : 100 pieces
R113 666 000	5	50	9	9.4	6	3	0.5		P 06	Gold	Space saving pattern
R113 666 020	5	50	9	9.4	6	3	0.5		P 06	BBR	Space saving pattern
R213 664 800●	2	75	6.5	9.5	6		0.83	M 12		Gold	SMT / reel 100 pieces
R213 665 000	3	75	10.5	9.5	6	4	0.83		P 05	Gold	

DEMONSTRATION BOARDS

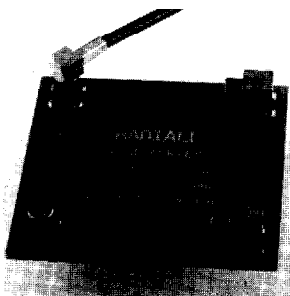

part number	imp. (Ω)
R113 900 520	50
R213 900 520	75

Including straight and right angle through holes and SMT pins receptacles.

● Upon request.

IN SERIES ADAPTORS (FEMALE - FEMALE)

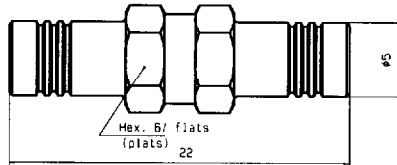
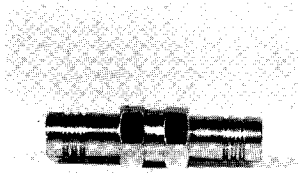

part number	imp.(Ω)	finish
R113 704 000	50	Gold
R113 704 020	50	Nickel

BETWEEN-SERIES ADAPTORS (R191 xxx xxx = 50 Ω - R192 xxx xxx = 75 Ω)

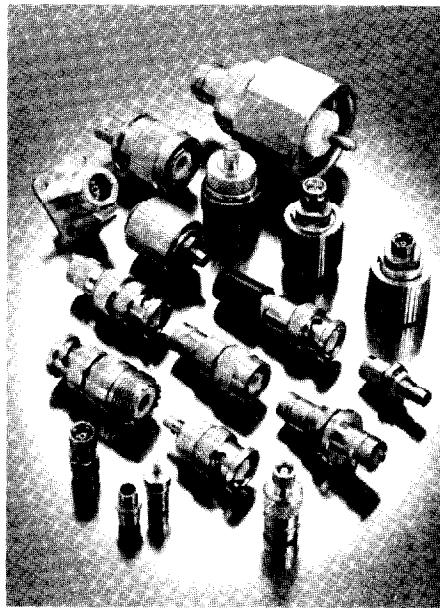

For more precisions, see our detailed catalogue "BETWEEN SERIES COAXIAL ADAPTORS" (D1 191 CE).

	MCX male	MCX female	MCX female, flange mount
SMA Male	R191 385 000	R191 386 000	
SMA Female	R191 388 000	R191 387 000	
SMA Female, bulkhead mount	R191 387 170● R191 387 277●		
BNC male	R191 471 000●	R191 473 000● R192 473 007	
BNC Female	R191 475 000● R192 475 007●	R191 477 000●	
TNC Female			R191 527 400●
PC7	R191 041 000●	R191 043 000●	

● Upon request.

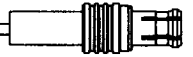

PCB CABLE TERMINALS (cable extremities to be soldered on PCB)

model cable	straight				right angle				45° angle
	crimp type		clamp type	solder type	crimp type		clamp type	solder type	crimp type
	2 pins	4 pins	4 pins	2 pins	2 pins	4 pins	4 pins	2 pins	2 pins
2/50/S (RG 178)	R280 280 000 R280 287 120 R280 280 020 (page 19)	R280 282 000 (page 19)	R280 281 000 (page 19)	R280 221 000 R280 221 020 (page 19)		R280 292 000 (page 20)	R280 291 000 (page 20)	R280 219 000 R280 219 008 R280 219 020 (page 20)	
2.6/50/S (RG 316)	R280 280 100 R280 280 120 (page 19)	R280 284 000 (page 19)	R280 283 000 (page 19)	R280 222 000 R280 222 020 (page 19)	R280 294 308 (page 20)	R280 294 000 (page 20)	R280 293 000 (page 20)	R280 220 007 R280 220 008 R280 220 200 R280 220 220 (page 20)	R280 296 000 (page 20)
2.6/75/S (RG 179)	R280 280 100 R280 280 120 (page 19)	R280 284 000 (page 19)	R280 283 000 (page 19)	R280 222 000 R280 222 020 (page 19)	R280 294 308 (page 20)	R280 294 000 (page 20)	R280 293 000 (page 20)	R280 220 007 R280 220 008 R280 220 200 R280 220 220 (page 20)	
2.6/50/D (RD 316)	R280 280 200 R280 280 220 (page 19)		R280 283 000 (page 19)				R280 293 000 (page 20)	R280 220 200 R280 220 220 (page 20)	R280 296 120 (page 20)
2.6/75/D (K 02253D-02)	R280 280 200 R280 280 220 (page 19)		R280 283 000 (page 19)				R280 293 000 (page 20)	R280 220 200 R280 220 220 (page 20)	
.047 (UT 47)				R280 287 100 R280 287 120 (page 19)					
.085 (RG 405)				R280 287 200 R280 287 220 (page 19)					

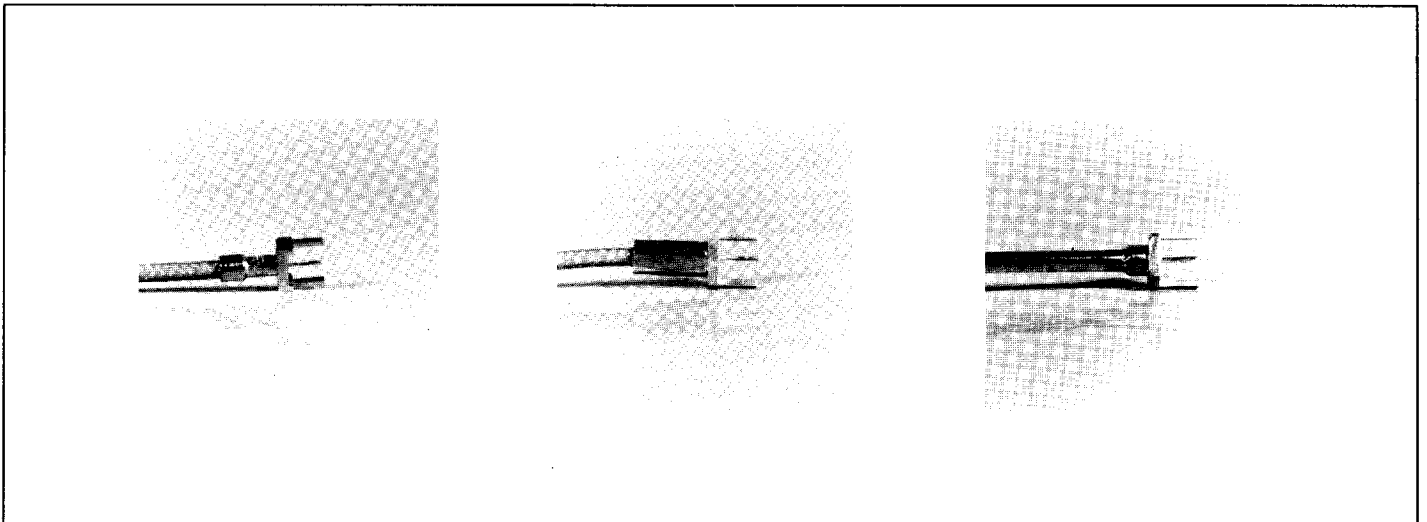

ATTENTION! This guide is intended as an information and does not include all COAXIAL TERMINALS P/Ns

STRAIGHT PCB CABLE TERMINALS

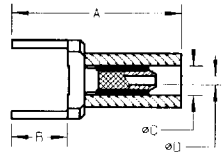
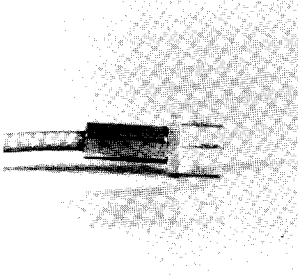

Fig. 1

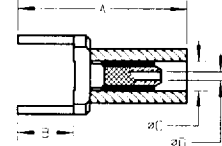
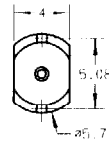

Fig. 2

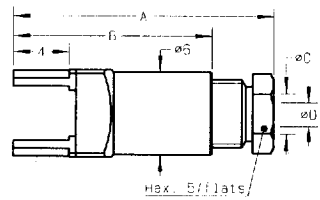
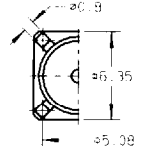

Fig. 3

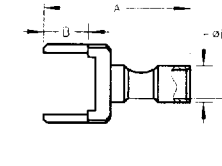
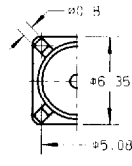

Fig. 4

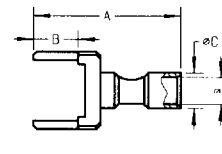
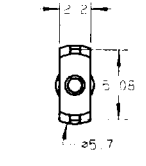

Fig. 5

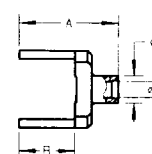
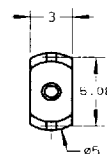
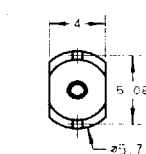

Fig. 6



cable group	part number	fig.	imp.(Ω)	dimensions (mm)				mounting	PCB	finish	note
				A	B	C	D				
2 /50/ S	R280 280 000	1	50	12.1	4	2.55	1.1	M 07	P 07	Gold	2 pins / crimp
2 /50/ S	R280 280 020	1	50	12.1	4	2.55	1.1	M 07	P 07	BBR	2 pins / crimp
2 /50/ S	R280 282 000	2	50	16.2	4	2.55	1	M 07	P 05	Gold	4 pins / crimp
2 /50/ S	R280 281 000	3	50	18.6	14.2	2.2	1	M 09	P 05	Nickel	4 pins / clamp
2 /50/ S	R280 221 000	4	50	10.5	3.2	2.7	1.45	M 11	P 07	Gold	2 pins / solder
2 /50/ S	R280 221 020●	4	50	10.5	3.2	2.7	1.45	M 11	P 07	BBR	2 pins / solder
2.6 / 50 + 75/ S	R280 280 100	1	50	12.1	4	2.95	1.65	M 07	P 07	Gold	2 pins / crimp
2.6 / 50 + 75/ S	R280 280 120	1	50	12.1	4	2.95	1.65	M 07	P 07	BBR	2 pins / crimp
2.6 / 50 + 75/ S	R280 284 000	2	50	17.2	4	3.25	1.7	M 07	P 05	Nickel	4 pins / crimp
2.6 / 50 + 75/ D	R280 280 200●	1	50	12.1	4	3.25	1.65	M 07	P 07	Gold	2 pins / crimp
2.6 / 50 + 75/ D	R280 280 220●	1	50	12.1	4	3.25	1.65	M 07	P 07	BBR	2 pins / crimp
2.6 / 50 + 75/ S	R280 283 000	3	50	18.6	14.2	3	1.7	M 09	P 05	Nickel	4 pins / clamp
2.6 / 50 + 75/ S	R280 222 000	5	50	8.4	3.2	3.15	2.3	M 11	P 07	Gold	2 pins / solder
2.6 / 50 + 75/ S	R280 222 020●	5	50	8.4	3.2	3.15	2.3	M 11	P 07	BBR	2 pins / solder
.047	R280 287 100●	6	50	7.1	4	2	1.3	M 08	P 07	Gold	2 pins / solder
.047	R280 287 120●	6	50	7.1	4	2	1.3	M 08	P 07	Tin lead	2 pins / solder
.085	R280 287 200	6	50	7.1	4	3	2.25	M 08	P 07	Gold	2 pins / solder
.085	R280 287 220●	6	50	7.1	4	3	2.25	M 08	P 07	Tin lead	2 pins / solder

● Upon request.

RIGHT ANGLE PCB CABLE TERMINALS

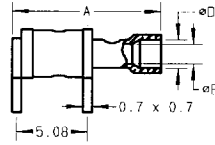
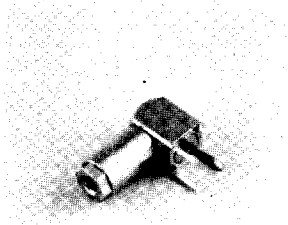

Fig. 1

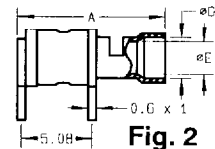

Fig. 2

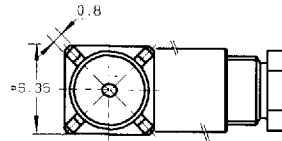

Fig. 3

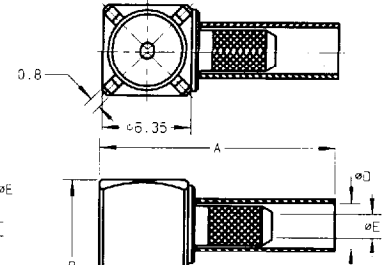

Fig. 4

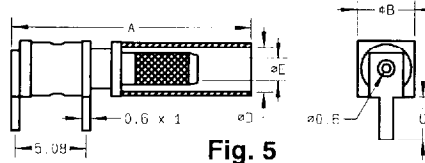
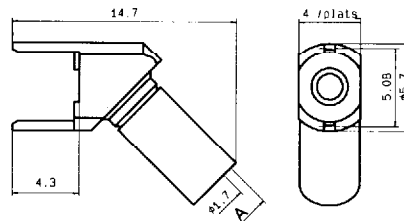
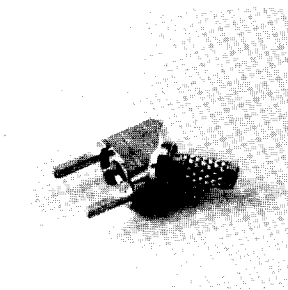

Fig. 5

cable group	part number	fig.	imp. (Ω)	dimensions (mm)					mounting	PCB	finish	note
				A	B	C	D	E				
2/50/S	R280 219 000	1	50	10.90	3.60	3.45	2.10	1.45	M 10	P 08	Gold	2 pins / solder
2 / 50 / S	R280 219 008●	1	50	10.90	3.60	3.45	2.10	1.45	M 10	P 08	Tin lead	2 pins / solder
2 / 50 / S	R280 219 020●	1	50	10.90	3.60	3.45	2.10	1.45	M 10	P 08	Tin lead	2 pins / solder
2.6 / 50+75/S	R280 220 007●	2	50	10.70	4.10	3.10	2.90	2.30	M 10	P 09	BBR	2 pins / solder
2.6 / 50+75/S	R280 220 008	2	50	10.70	4.10	3.10	2.90	2.30	M 10	P 09	Tin lead	2 pins / solder
2.6 / 50 / D	R280 220 200	1	50	10.90	4.10	3.10	2.90	2.40	M 10	P 08	Gold	2 pins / solder
2.6 / 50 / D	R280 220 220	1	50	10.90	4.10	3.10	2.90	2.40	M 10	P 08	Tin lead	2 pins / solder
2 / 50 / S	R280 291 000	3	50	19.80	12.70		2.20	1.00	M 09	P 05	Nickel	4 pins / clamp
2 / 50 / S	R280 292 000	4	50	16.85	12.70		2.55	1.00	M 07	P 05	Gold	4 pins / crimp
2.6 / 50+75/S	R280 293 000	3	50	19.80	12.70		3.00	1.70	M 09	P 05	Tin lead	4 pins / clamp
2.6 / 50+75/S	R280 294 000	4	50	16.85	12.70		3.25	1.70	M 07	P 05	Tin lead	4 pins / crimp
2.6 / 50+75/S	R280 294 308●	5	50	17.20	4.10	3.10	3.25	1.70	M 07	P 09	Nickel+tin lead	2 pins / crimp

45° ANGLE PCB TERMINALS



cable group	part number	imp. (Ω)	dimensions (mm)		mounting	PCB	finish
			A				
2.6 / 50 / S	R280 296 000	50	2.95		M 07	P 08	Tin lead
2.6 / 50 / D	R280 296 120	50	3.25		M 07	P 08	Tin lead

● Upon request.

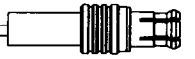

CRIMP TOOLS (for flexible cables Ø .079 (2) and .102 (2.6) single and double screen)

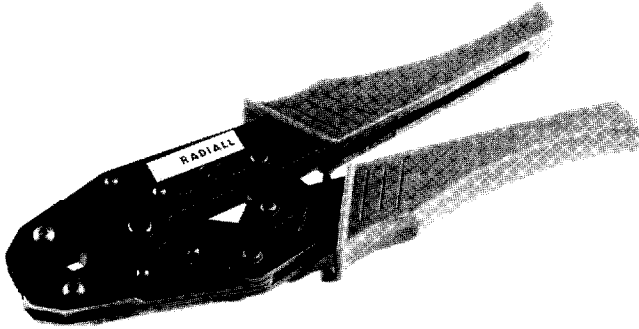

PART NUMBER	Dies size : inch (mm)
R282 211 000	Hex .105 (2.67) Hex .128 (3.25) Hex .178 (4.52)
R282 271 000	□.028 (0.72) Hex .128 (3.25) Hex .131 (3.84)

CRIMP TOOLS

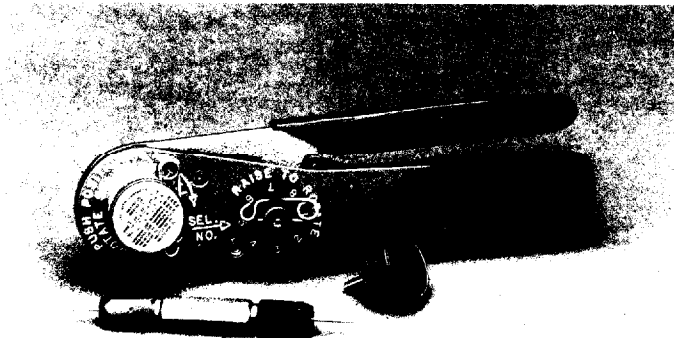

PART NUMBER	Tool
R282 281 000	Crimping tool 8 indents M 22520 /2-01
R282 983 000	Positioner for center contact

EXTRACTION TOOL FOR RIGHT ANGLE CONNECTORS AND CAP MOUNTING

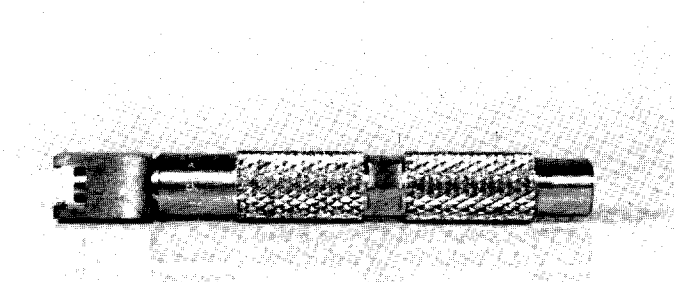

PART NUMBER	Flat dimension : inch (mm)
R282 868 000	.276 (7)

- This tool has two functions
- fitting of covers on right angle connectors
 - extraction of these models after coupling

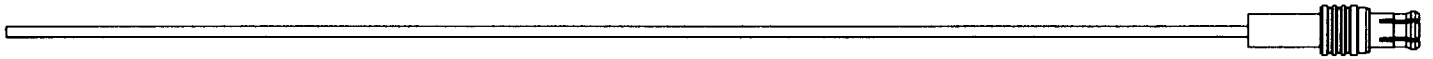

P01

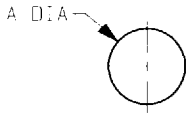

	MM		INCH	
	maxi	mini	maxi	mini
A	5	4.97	0.197	0.196

P02

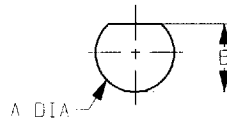

	MM		INCH	
	maxi	mini	maxi	mini
A	5	4.9	0.197	0.19
B	4.58	4.46	0.18	0.176

P03

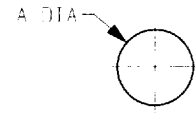

	MM		INCH	
	maxi	mini	maxi	mini
A	4.77	4.74	0.188	0.187

P04

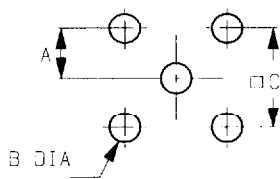

	MM		INCH	
	maxi	mini	maxi	mini
A	2.565	2.515	0.101	0.1
B	1.09	0.94	0.043	0.037
C	5.105	5.055	0.201	0.199

P05

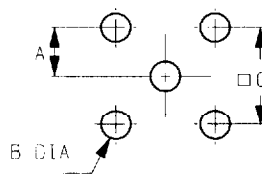

	MM		INCH	
	maxi	mini	maxi	mini
A	2.56	2.52	0.101	0.099
B	1.4	1.3	0.055	0.051
C	5.13	5.03	0.202	0.198

P06

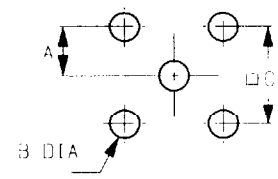

	MM		INCH	
	maxi	mini	maxi	mini
A	1.30	1.24	.051	.049
B	0.89	0.79	.035	.031
C	2.59	2.49	.102	.098

P07

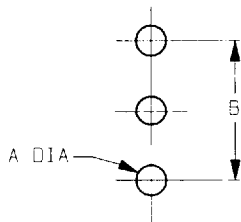

	MM		INCH	
	maxi	mini	maxi	mini
A	1.15	1.05	0.045	0.041
B	5.15	5.05	0.203	0.199

P08

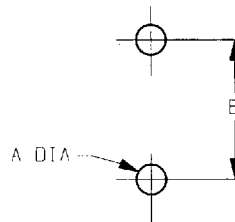

	MM		INCH	
	maxi	mini	maxi	mini
A	1.10	1.00	0.043	0.039
B	5.13	5.03	0.202	0.198

P09

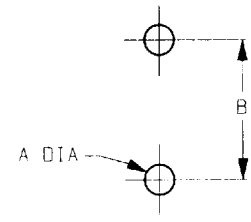

	MM		INCH	
	maxi	mini	maxi	mini
A	1.5	1.4	.059	.055
B	5.13	5.03	.202	.198

M 01

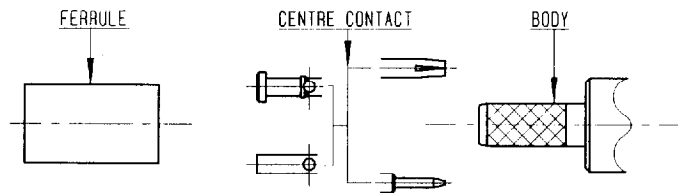

Connectors			Tooling
R113 030 005	R113 236 020	R113 310 020	<ul style="list-style-type: none"> For R113 030 005 crimping tool center contact : R282 281 000 + positioner R282 983 000 ferrule : R282 211 000 For all other part number crimping tool : R282 271 000
R113 081 000	R113 240 000	R113 311 000	
R113 081 020	R113 240 020	R113 311 020	
R113 082 000	R113 241 000	R113 312 000	
R113 082 020	R113 241 020	R213 082 007	
R113 083 000	R113 306 000	R213 083 007	
R113 083 020	R113 306 020	R213 238 007	
R113 236 000	R113 310 000	R213 239 007	

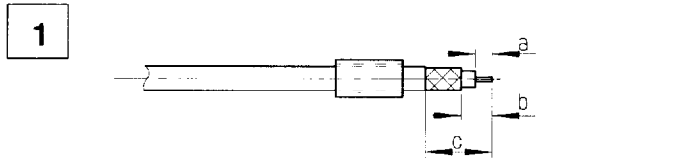

Connectors	stripping		
	a	b	c
R113 030 005	2.5	6.3	11.7
R113 081 000 R113 081 020 R113 082 000 R113 082 020 R113 083 000 R113 083 020 R113 236 000 R113 236 020 R113 240 000 R113 240 020	2.5	4	10
R213 082 007 R213 083 007	2.3	4.8	10.3

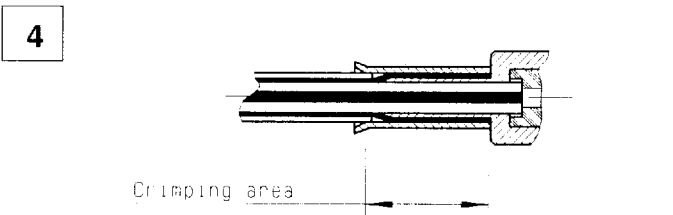
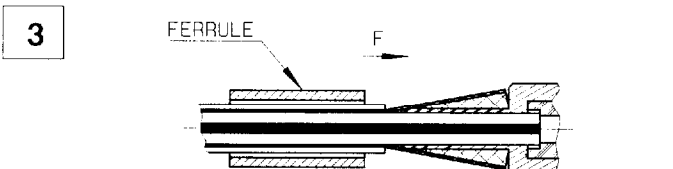
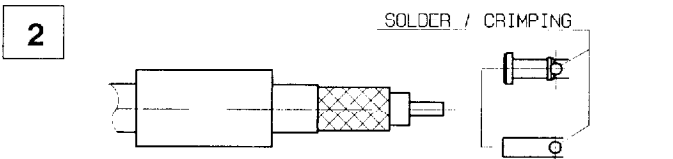

- 1-1 Slide the ferrule onto the cable .
- 1-2 Strip the cable .
- 2-1 Solder or crimp centre contact .
(crimping tool board)
- 3-1 Fan the braid .
- 3-2 Slide cable the body under the braid .
- 3-3 Slide the ferrule over the braid in direction F
- 4-1 Crimp the ferrule with crimping tool .
(crimping tool board)
- 4-2 Cut the excess of braid .

M 02

For cable .085"

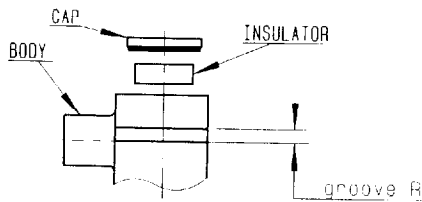

We recommend a thermal preconditioning of the cable

1

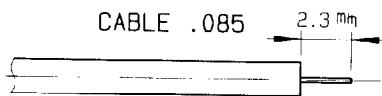

2

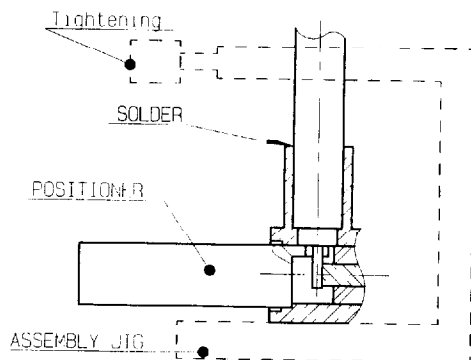

3

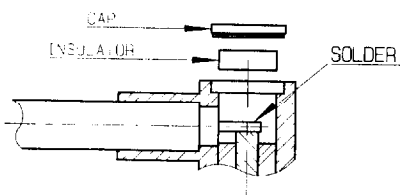

4

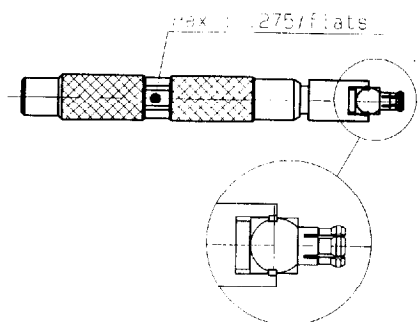

Connectors

R113 161 000
R113 161 020

- 1-1 Strip the cable.
- 1-2 clean the cable.
- 1-3 tin cable inner conductor.

- 2-1 Introduce the positioner R282 864 010 and the cable into the connector body until contact with the body shoulder, place the sub assembly into the assembly jig R282 740 020 and tighten it.
- 2-2 Solder body on the cable and let assembly cool down before removing it from the jig.
- 2-3 clean soldering area.

- 3-1 solder cable inner conductor into the centre contact.
- 3-2 clean soldering area.
- 3-3 Introduce the insulator into the body.
- 3-4 Press fit the cap.

- 4-1 Slide mounting tool R282 868 onto the body grooves .
- 4-2 Press fit the cap turning tool handle with adapted wrench .275(AF) (cap in the same plan than square face) .

M 02

For cable 2 & 2.6/50

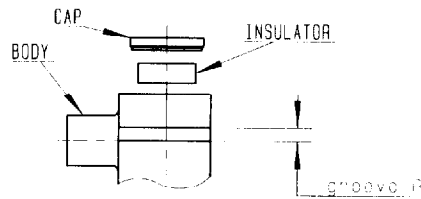

1

Stripping (mm) CABLE 2.6/50

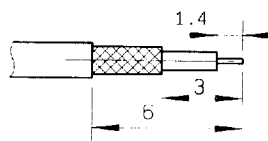

CABLE 2/50



2

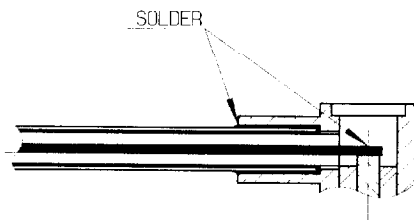

3

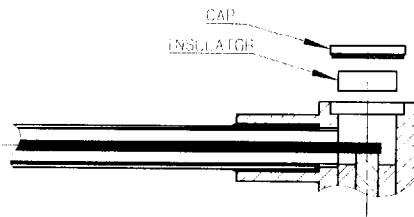

4

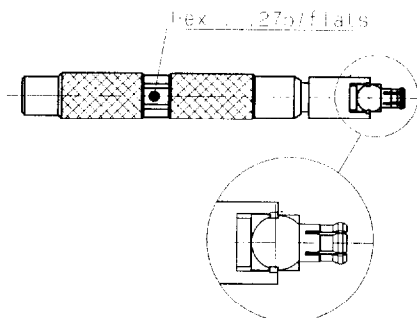

Connectors

R113 161 000
R113 161 020

for the 2.6/50 cable

- 1-1 Strip the cable.
- 1-2 tin cable inner conductor.

for the 2/50 cable

- 1-1 Strip the cable.
- 1-2 return the braid.
- 1-3 Strip the dielectric.
- 1-4 tin cable inner conductor.

- 2-1 push the cable into the connector body until contact with it.
- 2-2 solder the cable on the connector body.
- 2-3 solder cable inner conductor into the centre contact.
- 2-4 clean soldering area.

- 3-1 Introduce the insulator into the body.
- 3-2 Press fit the cap.

- 4-1 Slide mounting tool R282 868 onto the body grooves .
- 4-2 Press fit the cap turning tool handle with adapted wrench .275(AF) (cap in the same plan than square face) .

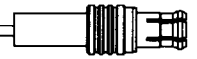

M 03

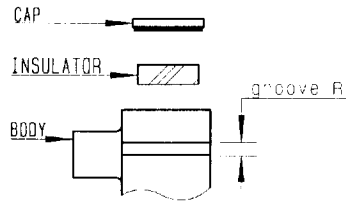

We recommend a thermal preconditioning of the cable

1



Connectors	stripping	
	a	b
R113 151 000 R113 151 020	2.2	3.2
R113 155 000	2.7	

2

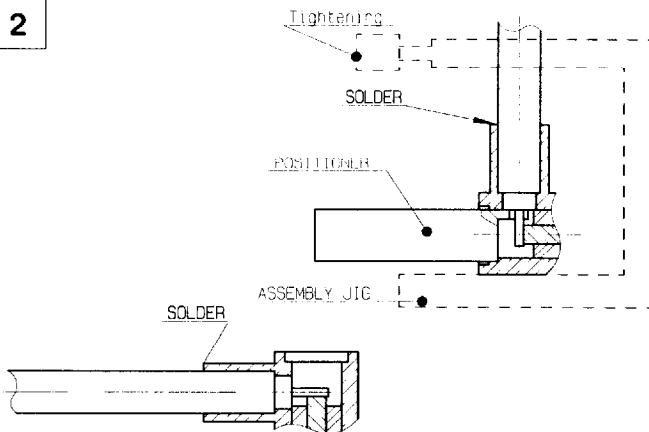

3

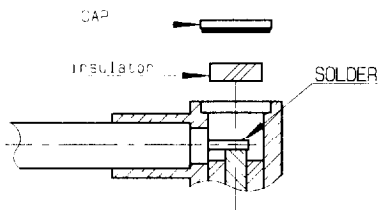

4

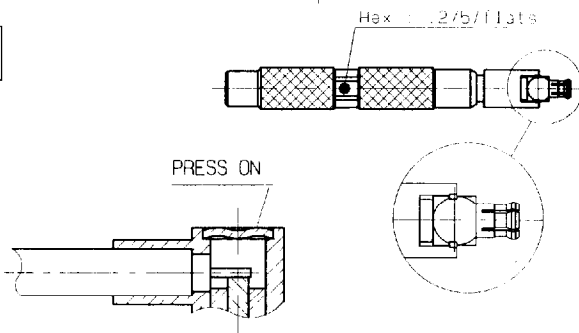

Connectors	Crimping instructions	
	positioner	for use
R113 151 000 R113 151 020	R282 864 000	Option 1
R113 153 000 R113 153 020	R282 864 010	Option 1
R113 155 000		Option 2

- 1-1 Strip the cable .
- 1-2 Tin the center conductor .
- 1-3 Clean the soldering area .

option 1

- 2-1 Introduce the positioner and the cable into the connector body until contact with the body shoulder, place the sub assembly into the assembly jig R282 740 020 and tighten it.
- 2-2 Solder body on the cable and let assembly cool down before removing it from the jig.
- 2-3 clean soldering area.

option 2

- 2-1 Push the cable into the connector body until it bottoms out .
- 2-2 Solder the body .
- 2-3 Clean the soldering area .

- 3-1 solder the cable inner conductor
- 3-2 clean solder area
- 3-3 introduce the insulator into the body
- 3-4 place the cap

option 1

- 4-1 Slide mounting tool R282 868 onto the body grooves .
- 4-2 Press fit the cap turning tool handle with adapted wrench .275(AF) (cap in the same plan than square face) .

option 2

- 4-1 Place the cap .
- 4-2 Press cap flush or slightly below surface of body assembly .

M 04

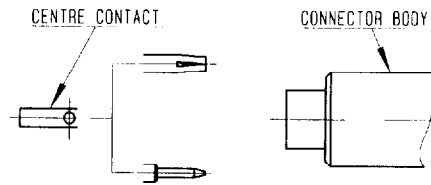
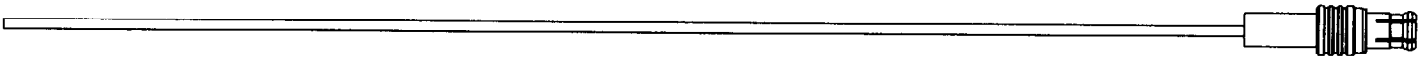

We recommend a thermal preconditioning of the cable

1



Connectors		
R113 051 000	R113 221 000	R113 301 000
R113 051 020	R113 221 020	R113 301 020
R113 053 000	R113 223 000	R113 303 000
R113 053 020	R113 223 020	R113 303 020

1-1 Strip the cable .

2

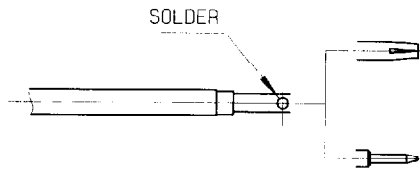

- 2-1 Tin centre contact solder pot
- 2-2 Solder the cable inner conductor into centre contact.
- 2-3 Clean solder area.

3

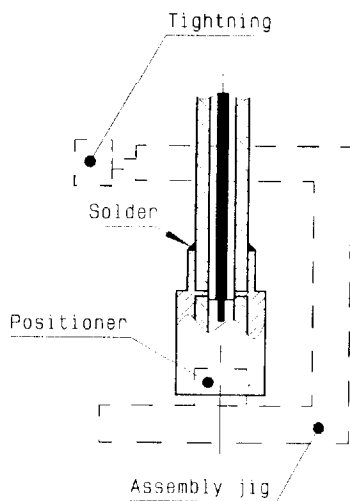

- 3-1 Introduce the cable into the connector body until contact with the body shoulder.
- 3-2 Place the sub assembly into the assembly jig R282 740 020 (or equivalent) with positioner MCX male and tighten it .
- 3-3 Solder body on the cable . Let the assembly cool down before removing it from the jig .
- 3-4 Clean solder .

M 05

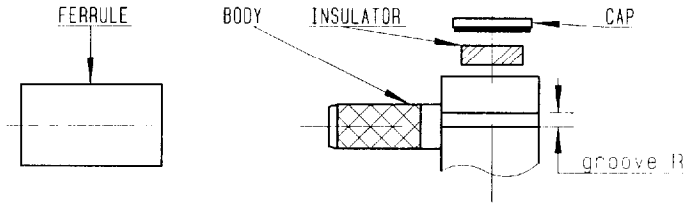

1

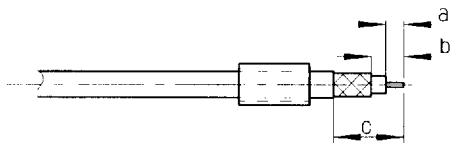

Connectors		stripping		
		a	b	c
R113 181 000	R113 182 020	2	3	8
R113 181 020	R113 183 000			
R113 182 000	R113 183 020			
R213 182 007	R213 183 007	1.7	4.2	9.7

2

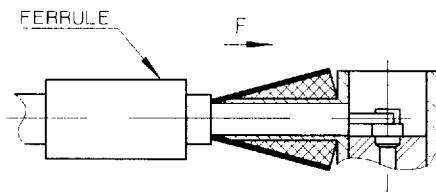

3

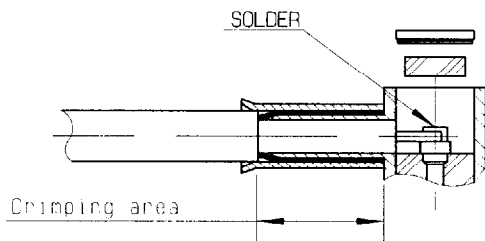

4

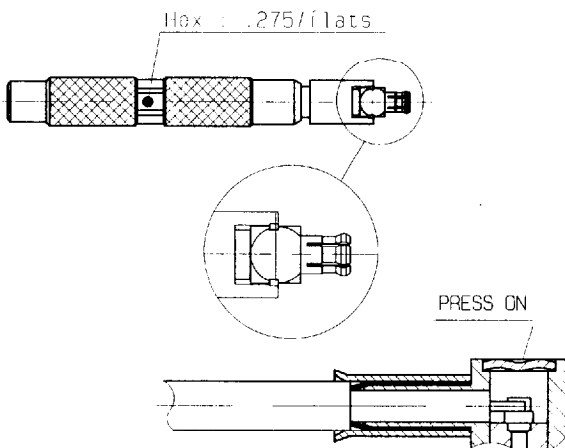

Connectors	Instructions	
	tool	operation
R113 181 000 R113 181 020 R113 182 000 R113 182 020 R113 183 000 R113 183 020	R282 271 000	Option 1
R213 182 007 R213 183 007		Option 2

- 1-1 Slide onto the cable the ferrule .
- 1-2 Strip the cable .
- 1-3 Tin cable inner conductor .

- 2-1 Fan the braid .
- 2-2 Push connector body under the braid .
- 2-3 Slide the ferrule on the braid
(in direction F)

- 3-1 Crimp the ferrule with crimping tool
- 3-2 Solder inner conductor .
- 3-3 Introduce the insulator into the body .

option 1

- 4-1 Slide mounting tool R282 868 onto the body grooves .
- 4-2 Press fit the cap turning tool handle with adapted wrench .275(AF) (cap in the same plan than square face) .

option 2

- 4-1 Place the cap .
- 4-2 Press cap flush or slightly below surface of body assembly .

M 06

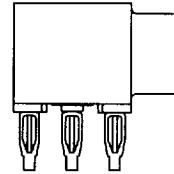
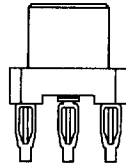

1

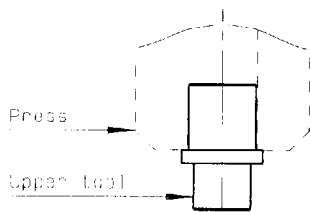

2

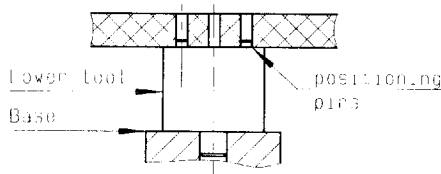

3

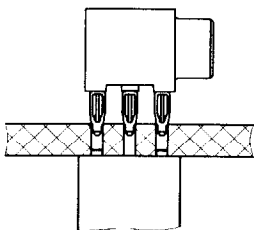

4

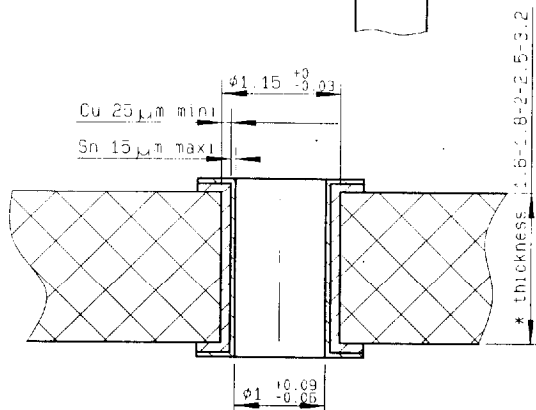
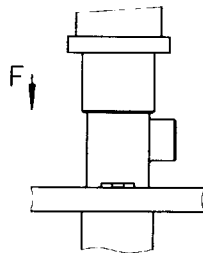

Connectors	Upper tool board
R113 416 000 R113 416 020	R282 878 140
R113 416 161	R282 878 130
R113 661 000 R113 661 020	R282 878 523
R113 661 027	R282 878 500

1-1 Slide the upper tool (look at upper tool board) into the machine (press) or the flat tool.

2-1 Slide the lower tool (R282.878.523) into the base and place correctly the PCB on this tool (positioning pins)

3-1 Place correctly the right angle connector with press-fit termination on the PCB and introduce the press-fit extremity in the holes of the PCB .

4-1 Push on the top (about 500 N) until total insertion (in direction F) (Push connector body until it bottoms against PCB) .

4-2 Remove the connector and the PCB assembly .

PC BOARD	GLASS FIBRE EPOXYD NOMA:G10 G11,FR4,FR5
MATERIAL	DIN 40802 : EP-GC 01 , EP-GC 02
HOLE	FOR 1mm COMPLIANT PIN

M 07

FERRULE

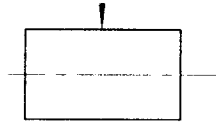

BODY

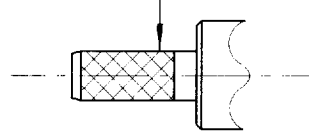

1

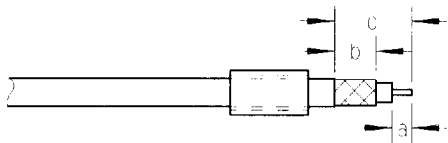

Connectors	stripping		
	a	b	c
R280 280 000 R280 280 020 R280 280 120	4	6	10
R280 280 100		5.9	11.2
R280 282 000		7	12
R280 284 000	*	6	*
R280 292 000	3.5	5.5	14
R280 294 000			17.5
R280 294 308	2.5	6	14.5
R280 296 000	4	5.5	

* : dimension specified by user or be optional

2

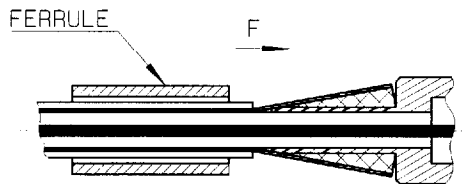

3

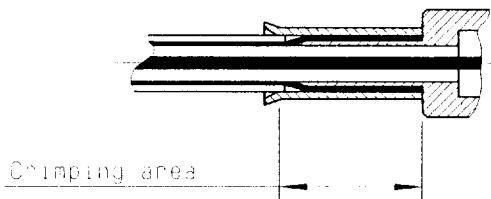

Connectors		Crimping instructions
		crimp tool
R280 280 000 R280 280 020 R280 280 100 R280 280 120 R280 280 200	R280 280 220 R280 284 000 R280 294 000 R280 294 308	R282 271 000 or R282 211 000 Hex. 3.5
R280 282 000	R280 292 000	R282 211 000 Hex. 2.67

1-1 Slide the ferrule onto the cable .

1-2 Strip the cable .

2-1 Fan the braid .

2-2 Slide cable into the body

2-3 Slide ferrule over the braid .
(In direction F)

3-1 Crimp the ferrule with crimping tool
R 282 271 000 (Hex. : 3.25) or
crimping tool M22520/5-01 (R 282 293 000)
+ dies M22520/5-03 (R 282 235 003)

3-2 Cut the excess of braid .

M 08

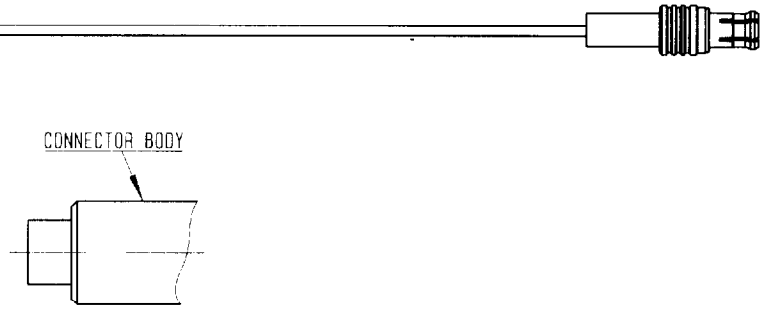

We recommend a thermal preconditioning of the cable

1



2

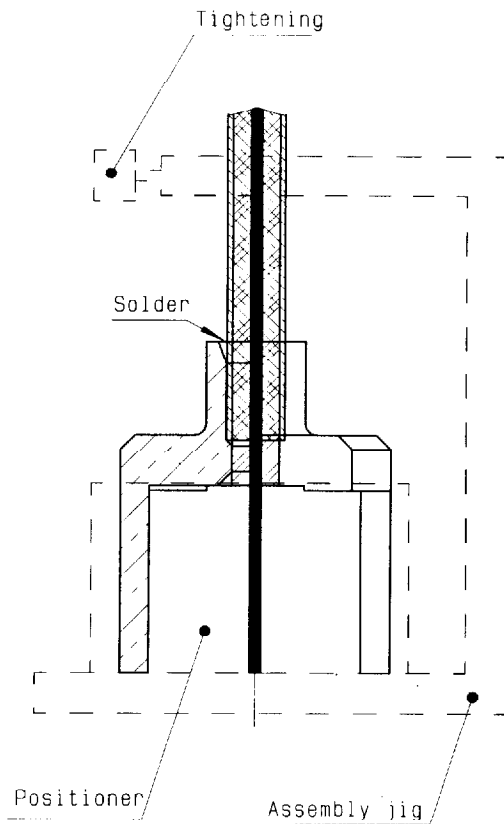

Connectors

R280 287 100
R280 287 120

R280 287 200
R280 287 220

1-1 Strip the cable .

2-1 Introduce the cable into the connector body until contact with the body shoulder.

2-2 Place the sub assembly into the assembly jig R 282 740 020 (or equivalent) with positionner R 282 863 000 and tighten it.

3-1 Solder the body on the cable.

3-2 Let the assembly cool down before removing it from the jig

3-3 Clean solder .

M 09

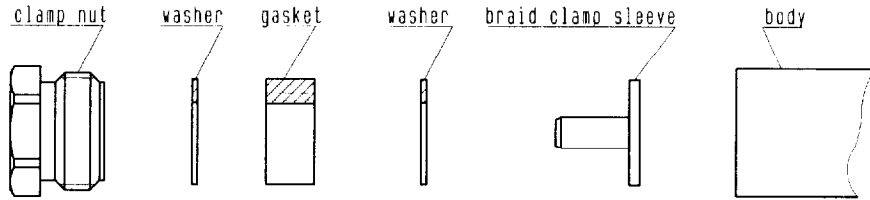

1

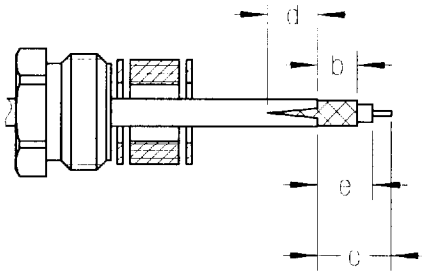

Connectors	stripping			d	e	recommended coupling torque
	a	b	c			
R280 281 000	4	*	6.5	4.5	*	40 Ncm
R280 283 000	*	*	*		*	
R280 291 000	4	5.5	15.5		11.5	4.75 in lb
R280 293 000	*	*	*		*	40 Ncm

* : dimension specified by user or be optional

Connectors	
R280 281 000	R280 291 000
R280 283 000	R280 293 000

- 1-1 slide the clamp nut the 1st washer, the gasket and the 2nd washer onto the cable .
- 1-2 strip the cable out the jacket (2 slots)

2

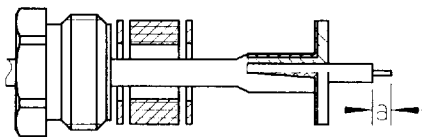

- 2-1 Slide clamp braid sleeve under braid .
- 2-2 Cut the braid flush with the clamp braid sleeve .
- 2-3 Strip the dielectric as shown .

3

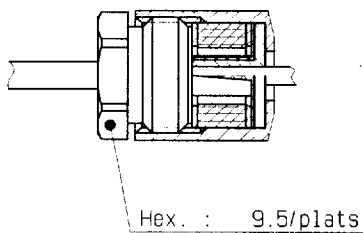

- 3-1 Screw sub-assembly into the connector body .

M 10

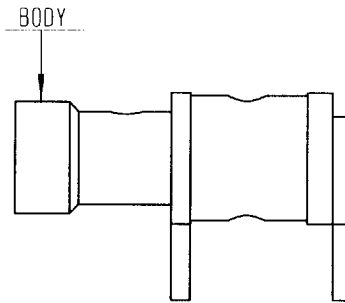

1

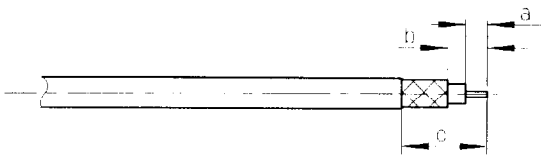

Connectors	stripping		
	a	b	c
R280 219 000	1.6	5.1	8.6
R280 220 008	3	6.5	9.5
R280 220 200	1.6	5.1	8.6

Connectors
R280 219 000
R280 220 008
R280 220 200

1-1 Strip the cable .

2

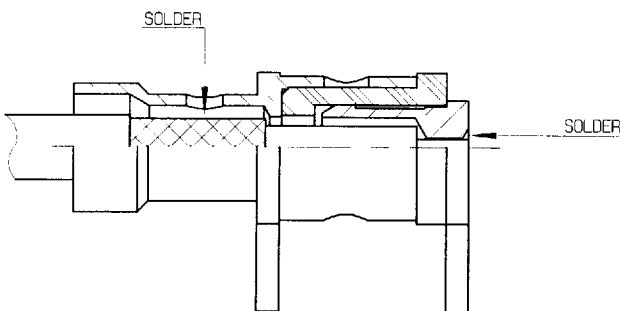

- 2-1 Introduce cable into the connector body until contact with it
- 2-2 Solder braid .
- 2-3 Solder cable core .

M 11

CONNECTOR BODY

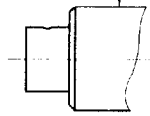

1

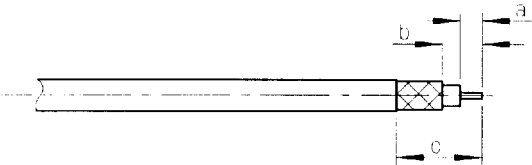

Connectors		stripping		
		a	b	c
R280 221 000	R280 221 020	4	6.5	10.5
R280 222 000	R280 222 020	4	6	8.5

Connectors

R280 221 000
R280 221 020

R280 222 000
R280 222 020

1-1 Strip the cable .

2

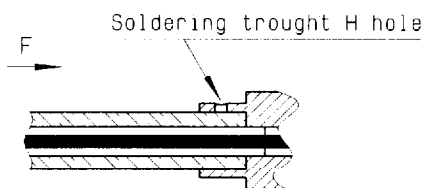

- 2-1 Introduce cable into the connector body until contact with it according to F direction
- 2-2 Solder the braid on the body .

M 12

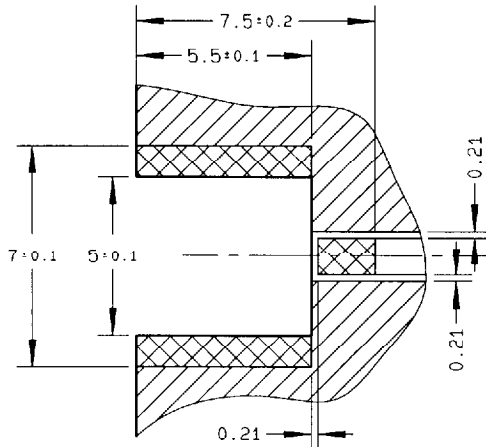

Video shadow R113 423 000

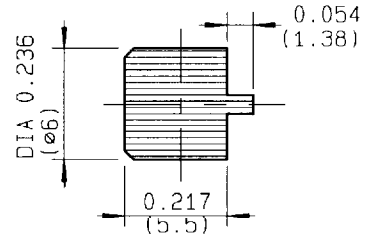

Video shadow R113 424 000 R113 424 020
R113 424 010 R213 424 800

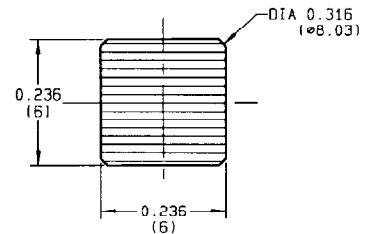

Connectors
R113 423 000

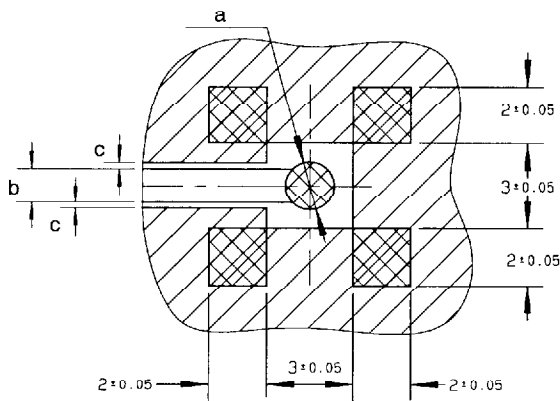

Video shadow R113 664 000 R113 664 120
R113 664 100 R213 664 800

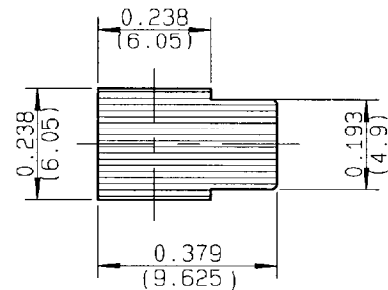

Connectors	a	b	c
R113 424 000 R113 424 010 R113 424 020 R113 664 000 R113 664 100 R113 664 120	$\emptyset 1.7^{+0.1}$	1.2	0.21
R213 424 800 R213 664 800	$\emptyset 1.57^{+0.1}$	1	0.63

Vacuum nozzle dimensions

(MCX 50Ω)

(MCX 75Ω)

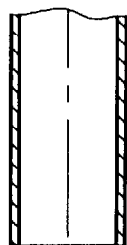
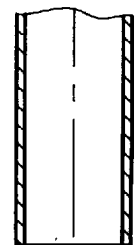

DIA $0.112^{+0.002}$
($\emptyset 2.85^{+0.05}$)
DIA $0.132^{+0.0012}$
($\emptyset 3.35^{+0.03}$)

DIA 0.066
($\emptyset 1.675$)
DIA 0.056
($\emptyset 1.425$)

Pattern

Land for solder paste

COPLANAR LINE
Pattern and signal are on the same side
Thickness of PCB : .063 (1.6 mm)
The material of PCB is the epoxy resin
of glass fabrics base. (Er = 4.8)
The solder resist should be printed
except for the land pattern on the PCB.

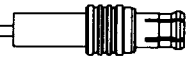

M 12 (flg)

A - SOLDERING PROCEDURE USING AUTOMATIC PICK AND PLACE EQUIPMENT :

1) Solder paste :

- RADIALL recommends using a **solder paste Sn63-Pb35-Ag2 type** (63% tin - 35% lead - 2% silver) "no clean - low residue" (50% solid residue of flux quantity) that will permit the **elimination of the cleaning operation step** after soldering
- When using a conventional solder paste with high level (50%) of flux solid residue, it is important to incorporate a good cleaning operation step, similar to what is described below in paragraph 5.
- Note : when choosing a solder paste for gold-plated PCB pattern, it is important to use a paste made with silver. This will help in avoiding formation of intermetallics as part of the solder joint.

2) Solder paste deposition :

- The solder paste should be deposited on the designated zone areas (see patterns p35) by a screen printing process. RADIALL advises a thickness of .008" (0.2 mm).
- If using a thickness of less than .008" (0.2mm) the zone area must be specifically designed for this thickness (please consult RADIALL)
- Please optically verify that the edges of the zone are clean and without contaminants.

3) Placement of the component :

- Place the receptacle onto the PCB with automatic pick and place equipment. Please verify that the PCB zoned areas have not oxidised.
- Various types of suction can be used (see vacuum nozzle dimensions p 35).
- RADIALL does not recommend using adhesive agents on the receptacle or on the PCB
- The use of a video camera is preferred for checking the positioning of the components (see video shadows p 35)

4) Soldering : infra-red reflow process :

- Please follow RADIALL's recommended profile as illustrated.
- When using a "no clean - low residue" type of solder paste, RADIALL recommends a linear pre-heat profile not to exceed 160°C with a 1 to 2°C /s. rise.

5) Cleaning of the PCB :

- When using a conventional solder paste with high level of residue, please clean the PCB with a substitute product, similar to CFC, that complies to the International Environmental Agency rules.
- RADIALL recommends using a vapor phase process (ultrasonic waves are allowable)

6) Quality Check :

- Verify by visual inspection that center contact of the receptacle has not been contaminated by solder or flux.
- Solder joints : verify by visual inspection that the formation of meniscus on the sides of the receptacle legs are proper.

B - SOLDERING PROCEDURE BY MANUAL OPERATION :

1) Solder paste : (Refer to procedure A - 1)

2) Flux deposition :

- Deposite a thin layer of flux on mounting zone.
- Allow the flux to evaporate a few seconds before applying the solder paste (in order to avoid dilution of the paste).

3) Solder paste deposition :

- Deposite a small quantity of solder paste on mounting zone area by syringe.
- Be careful, do not apply solder paste outside of the zone area.

4) Placement of the component :

- Lift the body of the receptacle by tweezers. Do not use fingers (fingers risk twisting the legs of the receptacle or ejecting the center contact and can contaminate contact surfaces)
- Place the component on the mounting zone by pressing lightly on the top of the receptacle with tweezers. The receptacle legs will stick into the solder paste.

5) Soldering :

- Pre-heat stage : use a heat gun (soldering iron is not recommended) at a distance of .800" (20 mm) from the receptacle, applying the jet of air in a continuous circular motion, until the solder paste starts to look dull. This stage avoids any thermal shock since both areas to be soldered are brought up to the same temperature.
- Final re-melting step is carried out by moving the heat gun to a closer distance of .200" (5 mm) from the receptacle while guiding the jet of air onto each receptacle leg, at a 45° angle.

6) Cleaning of the PCB : (Refer to procedure A - 5)

7) Quality check : (Refer to procedure A - 6)

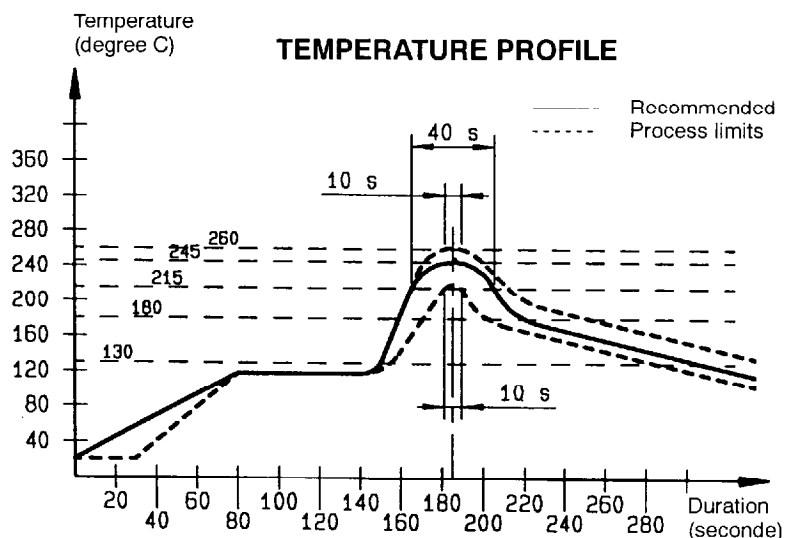



CABLE DIMENSIONS REFERENCE CHART

The following tables are presented as a convenient reference only. For detailed specifications, refer to the relevant standard or cable manufacturer's specifications. All dimensions are nominal unless otherwise specified.

CABLE	IMP. NOM. Ω	DIMENSIONS inch (mm)					CABLE GROUP inch (mm)/Ω
		CORE		DIELECTRIC	SCREEN DIA. + numb.	JACKET	
		Composition	DIA nom.				

FLEXIBLE AND SEMI-RIGID CABLES MIL - C - 17 - F

RG 6A/U	75	single core	.028 (0,72)	.185 (4,70)	.263 (6,70) (D)	.332 (8,43)	.315 (8)/75 D
RG 11A/U	75	7 X 0,40	.047 (1,20)	.285 (7,25)	.340 (8,64) (S)	.405 (10,29)	.394 (10)/75 S
RG 58C/U	50	19 X 0,18	.035 (0,89)	.116 (2,95)	.150 (3,81) (S)	.195 (4,95)	.197 (5)/50 S
RG 59B/U	75	single core	.022 (0,57)	.146 (3,71)	.191 (4,85) (S)	.242 (6,15)	.236 (6)/75 S
RG 62B/U	93	single core	.025 (0,64)	.146 (3,71)	.191 (4,85) (S)	.242 (6,15)	.236 (6)/93 S
RG 71B/U	93	single core	.025 (0,64)	.146 (3,71)	.208 (5,28) (D)	.245 (6,22)	.236 (6)/93 D
RG 141A/U	50	single core	.039 (0,99)	.116 (2,95)	.146 (3,71) (S)	.190 (4,83)	.197 (5)/50 S
RG 142B/U	50	single core	.037 (0,94)	.116 (2,95)	.171 (4,34) (D)	.195 (4,95)	.197 (5)/50 D
RG 174A/U	50	7 X 0,16	.019 (0,48)	.060 (1,52)	.088 (2,24) (S)	.110 (2,79)	.102 (2,6)/50 S
RG 178B/U	50	7 X 0,10	.012 (0,30)	.033 (0,84)	.054 (1,37) (S)	.071 (1,80)	.079 (2)/50 S
RG 179B/U	75	7 X 0,10	.012 (0,30)	.063 (1,60)	.083 (2,13) (S)	.101 (2,54)	.102 (2,6)/75 S
RG 188A/U	50	7 X 0,18	.020 (0,51)	.060 (1,52)	.081 (2,06) (S)	.110 (2,79)	.102 (2,6)/50 S
RG 212/U	50	single core	.056 (1,41)	.185 (4,70)	.210 (5,34) (D)	.331 (8,43)	.315 (8)/50 D
RG 213/U	50	7 X 0,75	.089 (2,25)	.285 (7,25)	.340 (8,64) (S)	.405 (10,29)	.394 (10)/50 S
RG 214/U	50	7 X 0,75	.089 (2,25)	.285 (7,25)	.360 (9,14) (D)	.425 (10,80)	.433 (11)/50 D
RG 216/U	75	7 X 0,40	.047 (1,20)	.285 (7,25)	.360 (9,15) (D)	.425 (10,80)	.433 (11)/75 D
RG 217/U	50	single core	.106 (2,69)	.370 (9,40)	.463 (11,76) (D)	.545 (13,84)	.551 (14)/50 D
RG 218/U	50	single core	.195 (4,95)	.680 (17,27)	.760 (19,30) (S)	.870 (22,10)	.866 (22)/50 S
RG 316/U	50	7 x 0,17	.020 (0,51)	.060 (1,52)	.081 (2,06) (S)	.098 (2,49)	.102 (2,6)/50 S
RD 316	50	7 x 0,17	.020 (0,51)	.060 (1,52)	.087 (2,2) (D)	.110 (2,80)	.102 (2,6)/50 D
RG 401/U	50	single core	.064 (1,63)	.209 (5,31)	--	.250 (6,35)	.250"
RG 402/U	50	single core	.036 (0,92)	.117 (2,90)	--	.141 (3,58)	.141"
RG 405/U	50	single core	.020 (0,51)	.066 (1,68)	--	.087 (2,20)	.085"

FLEXIBLE CABLES NF-C 93-550 / SEMI-RIGID CABLES NF-C 93-551

KX 3B	50	7 X 0,16	.019 (0,48)	.059 (1,50)	.088 (2,23) (S)	.10 (2,54)	.102 (2,6)/50 S
KX 4	50	7 X 0,75	.089 (2,25)	.285 (7,25)	.340 (8,64) (S)	.405 (10,29)	.394 (10)/50 S
KX 6A	75	7 X 0,20	.024 (0,60)	.146 (3,70)	.191 (4,85) (S)	.240 (6,10)	.236 (6)/75 S
KX 8	75	7 X 0,40	.047 (1,20)	.285 (7,25)	.340 (8,64) (S)	.405 (10,29)	.394 (10)/75 S
KX 13	50	7 X 0,75	.089 (2,25)	.285 (7,25)	.360 (9,14) (D)	.425 (10,80)	.433 (11)/50 D
KX 14	50	single core	.197 (5,00)	.681 (17,30)	.760 (19,30) (S)	.870 (22,10)	.866 (22)/50 S
KX 15	50	19 X 0,18	.035 (0,89)	.116 (2,95)	.150 (3,81) (S)	.195 (4,95)	.197 (5)/50 S
KX 21A	50	7 X 0,10	.012 (0,30)	.034 (0,87)	.054 (1,37) (S)	.071 (1,80)	.079 (2)/50 S
KX 22A	50	7 X 0,18	.020 (0,51)	.059 (1,50)	.081 (2,06) (S)	.098 (2,50)	.102 (2,6)/50 S
KX 22D	50	7 X 0,17	.020 (0,51)	.059 (1,50)	.098 (2,50) (D)	.118 (3,00)	.102 (2,6)/50 D
KX 23	50	7 X 0,34	.040 (1,02)	.116 (2,95)	.171 (4,34) (D)	.200 (5,10)	.197 (5)/50 D
KX 24	50	7 X 0,80	.094 (2,40)	.285 (7,25)	.360 (9,14) (D)	.429 (10,90)	.433 (11)/50 D
KX 25	75	7 X 0,23	.028 (0,71)	.146 (3,70)	.176 (4,47) (S)	.232 (5,90)	.236 (6)/75 S
KX 30	93	single core	.025 (0,64)	.146 (3,70)	.191 (4,85) (S)	.242 (6,15)	.236 (6)/93 S
KX 52	75	single core	.025 (0,64)	.146 (3,70)	.185 (4,70) (S)	.240 (6,10)	.236 (6)/75 S
KS 1	50	single core	.020 (0,515)	.066 (1,67)	--	.086 (2,18)	.085"
KS 2	50	single core	.036 (0,915)	.118 (3,00)	--	.140 (3,58)	.141"
KS 3	50	single core	.064 (1,63)	.210 (5,33)	--	.250 (6,35)	.250"

CORRUGATED CABLES 50 Ω

HELIAX FSJ1-50A			.075 (1,90)	.185 (4,70)	.252 (6,40)	.291 (7,40)	1/4"/50 spirale
HELIAX FSJ4-50B			.142 (3,60)	.342 (8,70)	.480 (12,20)	.520 (13,20)	1/2"/50 spirale
GEDELEX 3,7/50 CCES - 1/2"			.140 (3,56)	.331 (8,40)	.472 (12,00)	.531 (13,50)	1/2"/50 spirale
GEDELEX 2,3/50 CC - 1/4"			.094 (2,40)	.236 (6,00)	.295 (7,50)	.394 (10,00)	1/4"/50 annulat.
HELIAX LDF4-50A			.189 (4,80)	.457 (11,60)	.551 (14,00)	.630 (16,00)	1/2"/50 annulat.
GEDELEX 4,8/50 CCFP - 1/2"			.189 (4,80)	.468 (11,90)	.543 (13,80)	.650 (16,50)	1/2"/50 annulat.

ETHERNET CABLES 50 Ω

ACOME P 1977 A (BULL approval)			.085 (2,17)	.242 (6,15)	.325 (8,26) (D)	.406 (10,30)	Ethernet
BELDEN 9880			.085 (2,17)	.247 (6,27)	.315 (8,00) (D)	.405 (10,28)	Ethernet
FILOTEX 63227			.085 (2,17)	.252 (6,40)	.327 (8,30) (D)	.406 (10,30)	Ethernet
BICC H8 112			.085 (2,17)	.250 (6,35)	.326 (8,29) (D)	.406 (10,30)	Ethernet
PRECICABLE CY 120			.094 (2,40)	.252 (6,40)	.323 (8,20) (D)	.406 (10,30)	Ethernet
TIMES A A4779			.087 (2,20)	.242 (6,14)	.370 (9,40) (D)	.409 (10,40)	Ethernet

(S) : 1 braid ; (D) : 2 braids

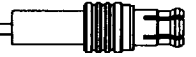

RADIALL Part Numbers	Page	RADIALL Part Numbers	Page	RADIALL Part Numbers	Page	RADIALL Part numbers	Page
R113 030 005	10	R113 303 020	13	R113 665 037	16	R280 219 020	20
R113 051 000	10	R113 306 000	13	R113 665 110	16	R280 220 007	20
R113 051 020	10	R113 306 020	13	R113 665 127	16	R280 220 008	20
R113 053 000	10	R113 310 000	13	R113 665 137	16	R280 220 200	20
R113 053 020	10	R113 310 020	13	R113 666 000	16	R280 220 220	20
R113 081 000	10	R113 311 000	13	R113 666 020	16	R280 221 000	19
R113 081 020	10	R113 311 020	13	R113 670 000	14	R280 221 020	19
R113 082 000	10	R113 312 000	13	R113 670 020	14	R280 222 000	19
R113 082 020	10	R113 402 220	14	R113 704 000	16	R280 222 020	19
R113 083 000	10	R113 416 000	15	R113 704 020	16	R280 280 000	19
R113 083 020	10	R113 416 020	15	R113 900 520	17	R280 280 020	19
R113 151 000	11	R113 423 000	15			R280 280 100	19
R113 151 020	11	R113 424 000	15	R191 041 000	17	R280 280 120	19
R113 153 000	11	R113 424 010	15	R191 043 000	17	R280 280 200	19
R113 153 020	11	R113 424 020	15	R191 387 170	17	R280 280 220	19
R113 155 000	11	R113 425 000	15	R191 471 000	17	R280 281 000	19
R113 161 000	11	R113 426 000	15	R191 473 000	17	R280 282 000	19
R113 161 020	11	R113 426 010	15	R191 475 000	17	R280 283 000	19
R113 181 000	11	R113 426 020	15	R191 477 000	17	R280 284 000	19
R113 181 020	11	R113 426 120	15	R191 527 400	17	R280 287 100	19
R113 182 000	11	R113 426 320	15			R280 287 120	19
R113 182 020	11	R113 427 000	15	R192 475 007	17	R280 287 200	19
R113 183 000	11	R113 427 020	15			R280 287 220	19
R113 183 020	11	R113 553 000	14	R213 082 007	10	R280 291 000	20
R113 221 000	12	R113 553 020	14	R213 083 007	10	R280 292 000	20
R113 221 020	12	R113 554 020	14	R213 182 007	11	R280 293 000	20
R113 223 000	12	R113 556 500	14	R213 183 007	11	R280 294 000	20
R113 223 020	12	R113 661 000	16	R213 238 007	12	R280 294 308	20
R113 236 000	12	R113 661 020	16	R213 239 007	12	R280 296 000	20
R113 236 020	12	R113 661 027	16	R213 424 800	15	R280 296 120	20
R113 240 000	12	R113 664 000	16	R213 426 000	15		
R113 240 020	12	R113 664 100	16	R213 664 800	16	R282 211 000	21
R113 241 000	12	R113 664 120	16	R213 900 520	17	R282 868 000	21
R113 241 020	12	R113 665 000	16			R282 271 000	21
R113 301 000	13	R113 665 010	16	R280 219 000	20	R282 281 000	21
R113 301 020	13	R113 665 020	16	R280 219 008	20	R282 983 000	21
R113 303 000	13						