



| | IAB110P | Units |
|---------------------|---------|-------|
| Load Voltage | 350 | V |
| Load Current | 100 | mA |
| Max R _{ON} | 35 | Ω |

Features

- Three Functions in One Package
- Small 16 Pin SOIC Package (PCMCIA Compatible)
- Bi-Directional Current Sensing
- Bi-Directional Current Switching
- 3750V_{RMS} Input/Output Isolation
- FCC Compatible
- No EMI/RFI Generation
- Machine Insertable, Wave Solderable
- Tape & Reel Versions Available

Applications

- Telecommunications
 - Telecom Switching
 - Tip/Ring Circuits
 - Modem Switching (Laptop, Notebook, Pocket Size)
 - Hookswitch
 - Dial Pulsing
 - Ground Start
 - Ringer Injection
- Instrumentation
 - Multiplexers
 - Data Acquisition
 - Electronic Switching
 - I/O Subsystems
 - Meters (Watt-Hour, Water, Gas)
- Medical Equipment-Patient/Equipment Isolation
- Security
- Aerospace
- Industrial Controls

Description

The IAB110P Multifunction Telecom switch combines a 350V Form A relay, 350V Form B relay and one optocoupler in a single package. The relay uses optically coupled MOSFET technology to provide 1500V of input to output isolation. The efficient MOSFET switches and photovoltaic die use Clare's patented OptoMOS architecture. The optically coupled input uses highly efficient GaAlAs infrared LEDs. IAB110P's allow telecom circuit designers to combine three discrete functions in a single component. The IAB110P's small package uses less space than traditional discrete component solutions.

Approvals

- UL Recognized: File Number E76270
- CSA Certified: File Number LR 43639-12
- VDE Compatible
- BSI Certified:
 - BS EN 60950:1992 (BS7002:1992) Certificate #:7969
 - BS EN 41003:1993 Certificate #:7969

Ordering Information

| Part # | Description |
|-----------|-------------------------|
| IAB110P | 16 Pin SOIC (50/Tube) |
| IAB110PTR | 16 Pin SOIC (1000/Reel) |

Pin Configuration

Switching Characteristics of Normally Open (Form A) Devices

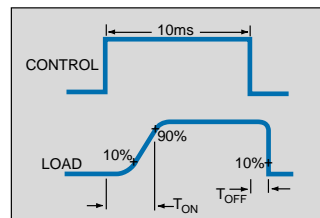

Switching Characteristics of Normally Closed (Form B) Devices

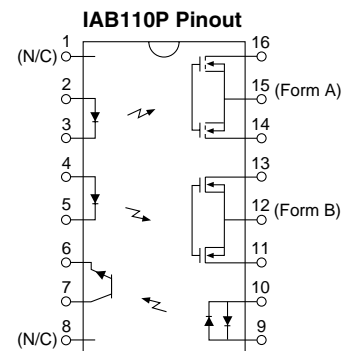
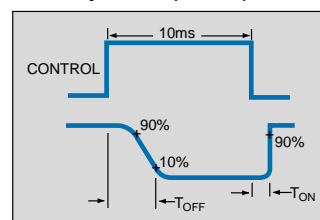

1. (N/C)
2. + LED - Form A Relay #1
3. - LED - Form A Relay #1
4. + LED - Form B Relay #2
5. - LED - Form B Relay #2
6. Emitter - Phototransistor
7. Collector - Phototransistor
8. (N/C)
9. LED - Phototransistor +/-
10. LED - Phototransistor -/+
11. Output - Form B Relay #2
12. Common Source Relay #2
13. Output - Form B Relay #2
14. Output - Form A Relay #1
15. Common Source Relay #1
16. Output - Form A Relay #1

Absolute Maximum Ratings (@ 25° C)

| Parameter | Min | Typ | Max | Units |
|--|------|-----|----------------|------------------|
| Total Package Dissipation | - | - | 1 ¹ | W |
| Isolation Voltage Input to Output | 3750 | - | - | V _{RMS} |
| Operational Temperature | -40 | - | +85 | °C |
| Storage Temperature | -40 | - | +125 | °C |
| Soldering Temperature (10 Seconds Max.) | - | - | +220 | °C |

¹ Above 25° derate linearly 1.67mw/°C

Absolute Maximum Ratings are stress ratings. Stresses in excess of these ratings can cause permanent damage to the device. Functional operation of the device at these or any other conditions beyond those indicated in the operational sections of this data sheet is not implied. Exposure of the device to the absolute maximum ratings for an extended period may degrade the device and effect its reliability.

Electrical Characteristics

| Parameter | Conditions | Symbol | Min | Typ | Max | Units |
|---|--|-------------------|------|-----|-----|------------------|
| Relay Portion | | | | | | |
| Output Characteristics @ 25°C | | | | | | |
| Load Voltage (Peak) | I _L = 1μA | V _L | - | - | 350 | V |
| Load Current (Continuous) | - | I _L | - | - | 100 | mA |
| Peak Load Current | 10ms | I _{LPK} | - | - | 350 | mA |
| On-Resistance | I _L = 100mA | R _{ON} | - | - | 35 | Ω |
| Off-State Leakage Current | V _L = 350V; T _J = 25°C | I _{LEAK} | - | - | 1 | μA |
| Switching Speeds | | | | | | |
| Turn-On | I _F = 5mA, V _L = 10V | T _{ON} | - | - | 3 | ms |
| Turn-Off | I _F = 5mA, V _L = 10V | T _{OFF} | - | - | 3 | ms |
| Output Capacitance | V _L = 50V, f = 1MHz | - | - | 25 | - | pF |
| Relay Portion | | | | | | |
| Input Characteristics @ 25°C | | | | | | |
| Input Control Current | I _L = 100mA | I _F | 5 | - | 50 | mA |
| Input Dropout Current | I _L = 1mA | I _F | 0.4 | - | - | mA |
| Input Voltage Drop | I _F = 5mA | V _F | 0.9 | 1.2 | 1.4 | V |
| Reverse Input Voltage | - | V _R | - | - | 5 | V |
| Reverse Input Current | V _R = 5V | I _R | - | - | 10 | μA |
| Detector Portion | | | | | | |
| Output Characteristics @ 25°C | | | | | | |
| Phototransistor Blocking Voltage | I _C = 10μA | BV _{CEO} | 20 | 50 | - | V |
| Phototransistor Dark Current | V _{CE} = 5V, I _F = 0mA | I _{CEO} | - | 50 | 500 | nA |
| Saturation Voltage | I _C = 2mA, I _F = 16mA | V _{SAT} | - | 0.3 | 0.5 | V |
| Current Transfer Ratio | I _F = 6mA, V _{CE} = 0.5V | C _{TR} | 33 | - | - | % |
| Detector Portion | | | | | | |
| Input Characteristics @ 25°C | | | | | | |
| Input Control Current | I _C = 2mA, V _{CE} = 0.5V | I _F | 6 | 2 | - | mA |
| Input Voltage Drop | I _F = 5mA | I _{CEO} | 0.9 | 1.2 | 1.4 | V |
| Input Current (Detector must be off) | I _C = 1μA, V _{CE} = 5V | - | 5 | 25 | - | μA |
| Input to Output Capacitance | V _L = 50V, f = 1MHz | C _{I/O} | - | 3 | - | pF |
| Input to Output Isolation | - | V _{I/O} | 3750 | - | - | V _{RMS} |

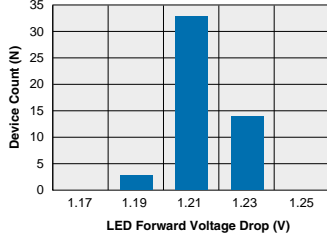
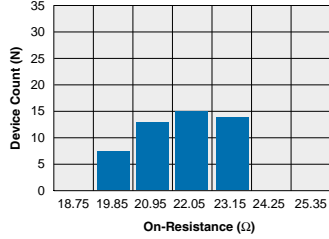
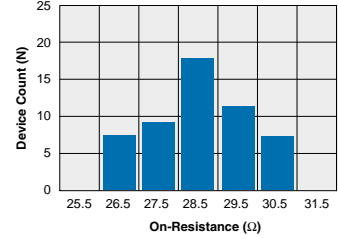
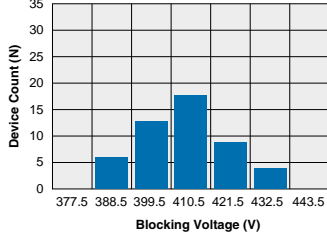
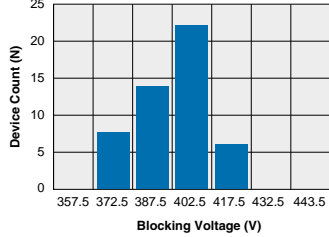
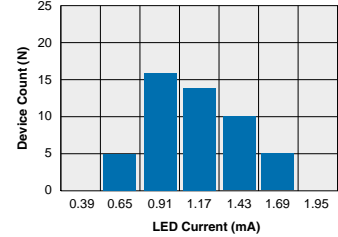
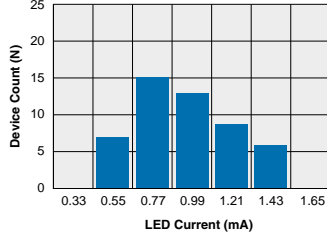
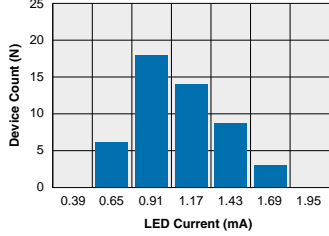
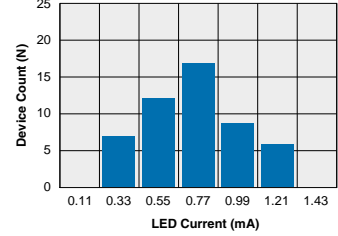
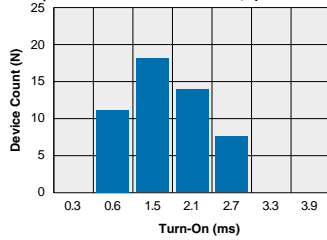
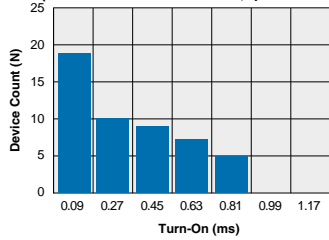
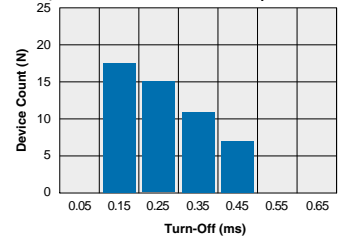
PERFORMANCE DATA*
IAB110P
Typical LED Forward Voltage Drop
 (N=50 Ambient Temperature = 25°C; I_F = 5mADC)

IAB110P - FormA
Typical On-Resistance Distribution
 (N=50 Ambient Temperature = 25°C)
 (Load Current = 100mADC, I_F=5mADC)

IAB110P - FormB
Typical On-Resistance Distribution
 (N=50 Ambient Temperature = 25°C)
 (Load Current = 100mADC, I_F=5mADC)

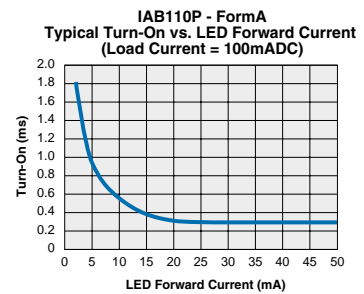
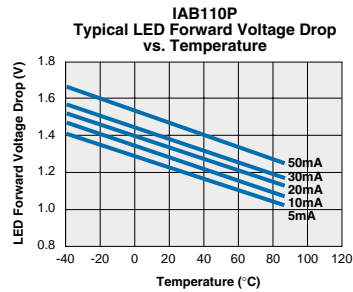
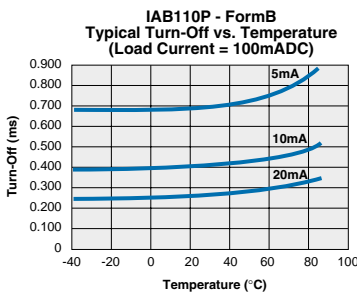
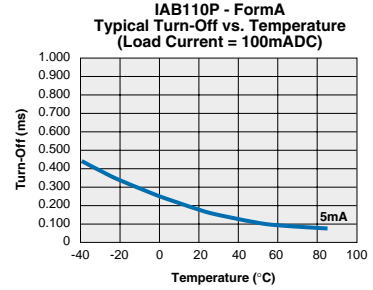
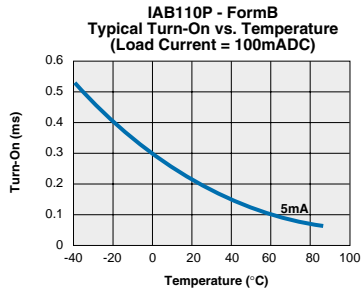
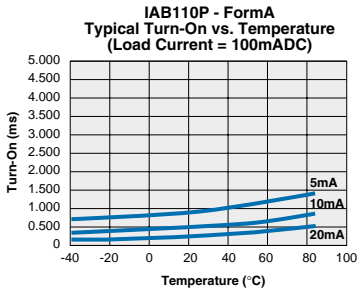
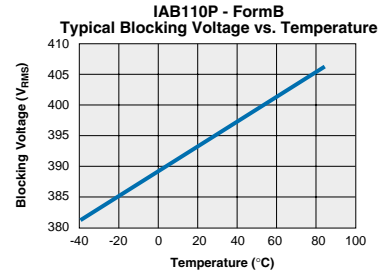
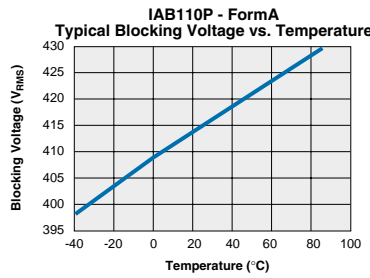
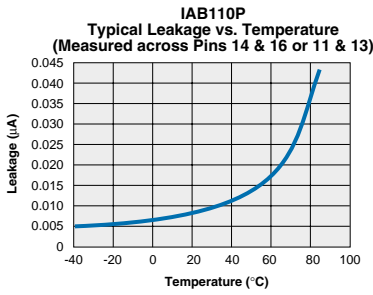
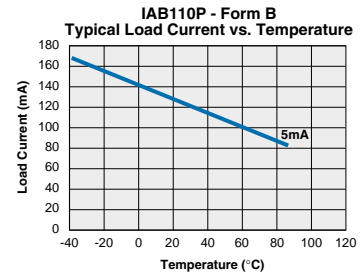
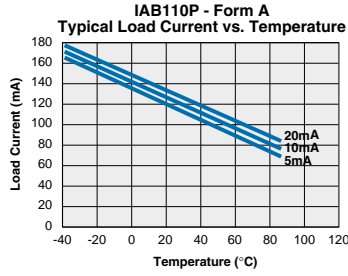
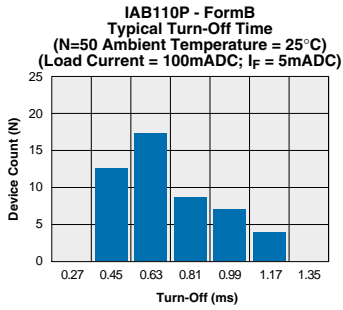
IAB110P - FormA
Typical Blocking Voltage Distribution
 (N=50 Ambient Temperature = 25°C)

IAB110P - FormB
Typical Blocking Voltage Distribution
 (N=50 Ambient Temperature = 25°C)

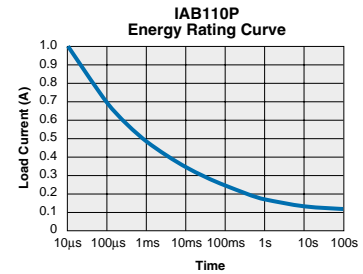
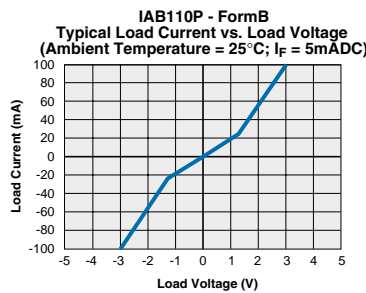
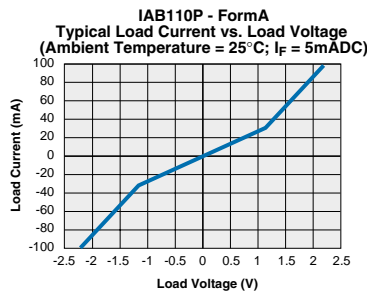
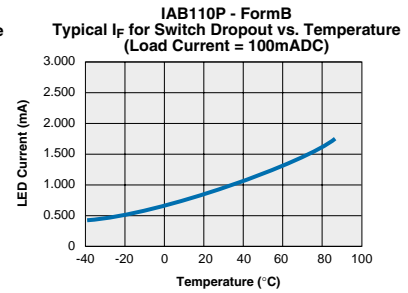
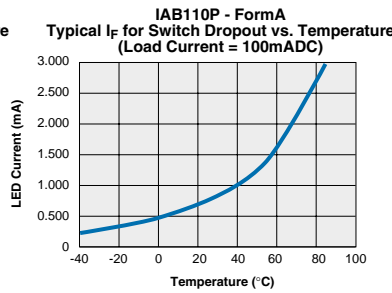
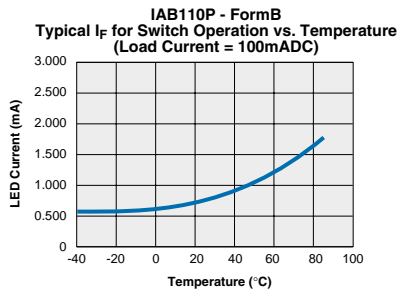
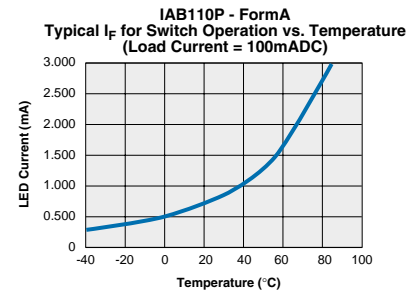
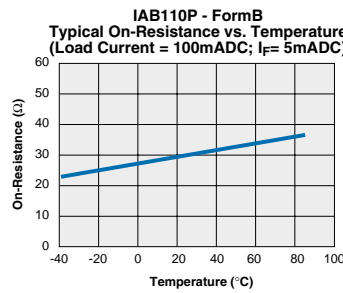
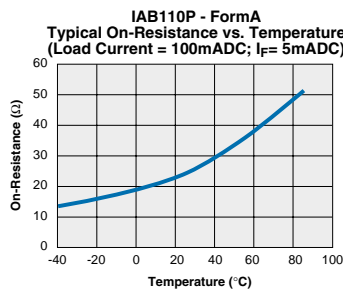
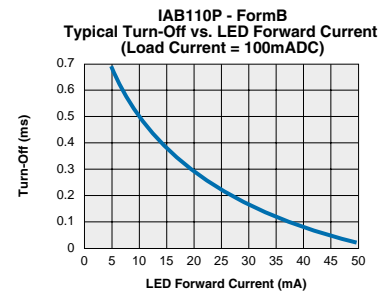
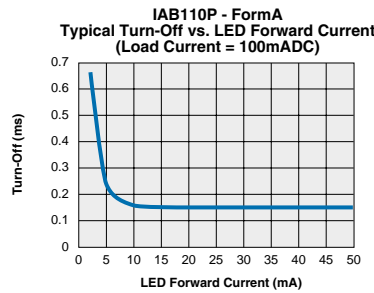
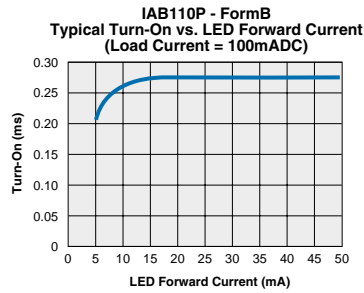
IAB110P - FormA
Typical I_F for Switch Operation
 (N=50 Ambient Temperature = 25°C)
 (Load Current = 100mADC)

IAB110P - FormB
Typical I_F for Switch Operation
 (N=50 Ambient Temperature = 25°C)
 (Load Current = 100mADC)

IAB110P - FormA
Typical I_F for Switch Dropout
 (N=50 Ambient Temperature = 25°C)
 (Load Current = 100mADC)

IAB110P - FormB
Typical I_F for Switch Dropout
 (N=50 Ambient Temperature = 25°C)
 (Load Current = 100mADC)

IAB110P - FormA
Typical Turn-On Time
 (N=50 Ambient Temperature = 25°C)
 (Load Current = 100mADC; I_F = 5mADC)

IAB110P - FormB
Typical Turn-On Time
 (N=50 Ambient Temperature = 25°C)
 (Load Current = 100mADC; I_F = 5mADC)

IAB110P - FormA
Typical Turn-Off Time
 (N=50 Ambient Temperature = 25°C)
 (Load Current = 100mADC; I_F = 5mADC)

The Performance data shown in the graphs above is typical of device performance. For guaranteed parameters not indicated in the written specifications, please contact our application department.

PERFORMANCE DATA*



*The Performance data shown in the graphs above is typical of device performance. For guaranteed parameters not indicated in the written specifications, please contact our application department.

PERFORMANCE DATA*

*The Performance data shown in the graphs above is typical of device performance. For guaranteed parameters not indicated in the written specifications, please contact our application department.

PERFORMANCE DATA*

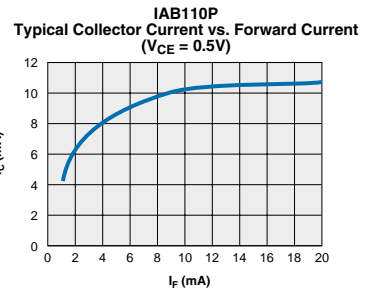
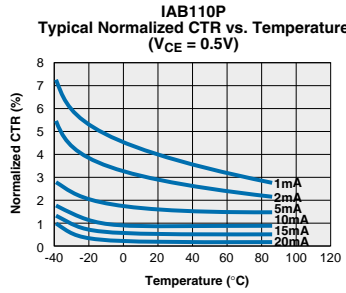
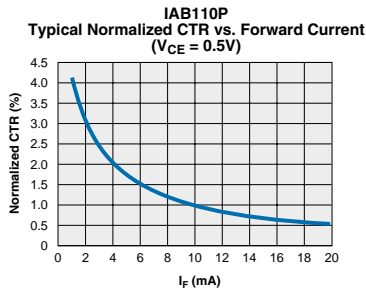

Mechanical Dimensions

16 Pin SOIC ("P" Suffix)

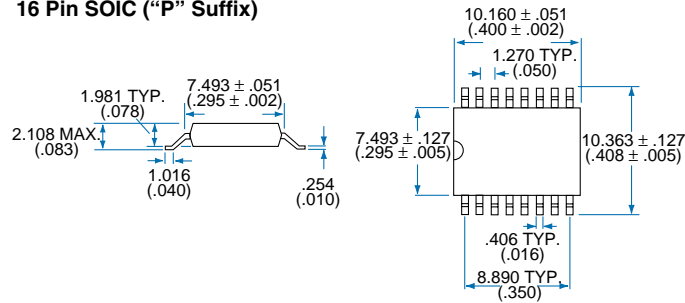

Tape and Reel Packaging for 16 Pin SOIC Package

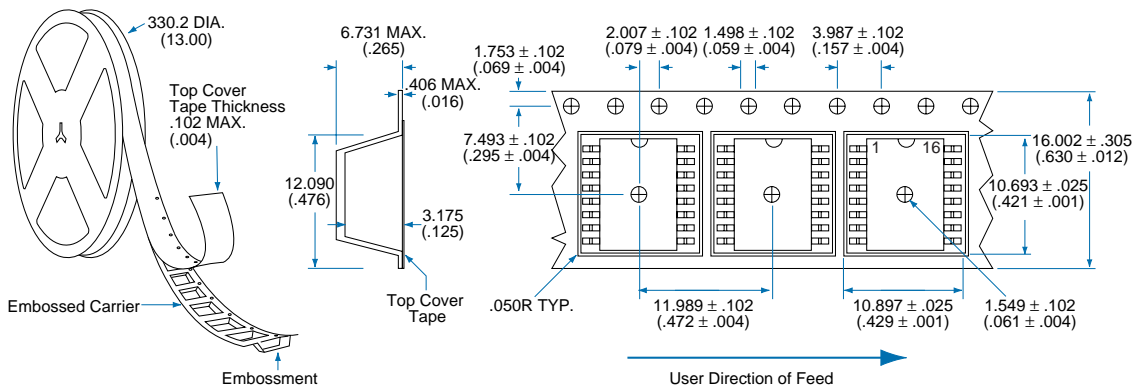

*The Performance data shown in the graphs above is typical of device performance. For guaranteed parameters not indicated in the written specifications, please contact our application department.



CLARE

For additional information please visit our website at: www.clare.com

Clare, Inc. makes no representations or warranties with respect to the accuracy or completeness of the contents of this publication and reserves the right to make changes to specifications and product descriptions at any time without notice. Neither circuit patent licenses nor indemnity are expressed or implied. Except as set forth in Clare's Standard Terms and Conditions of Sale, Clare, Inc. assumes no liability whatsoever, and disclaims any express or implied warranty, relating to its products including, but not limited to, the implied warranty of merchantability, fitness for a particular purpose, or infringement of any intellectual property right.

The products described in this document are not designed, intended, authorized or warranted for use as components in systems intended for surgical implant into the body, or in other applications intended to support or sustain life, or where malfunction of Clare's product may result in direct physical harm, injury, or death to a person or severe property or environmental damage. Clare, Inc. reserves the right to discontinue or make changes to its products at any time without notice.

Specification: DS-IAB110P-R2.0
©Copyright 2002, Clare, Inc.
All rights reserved. Printed in USA.
6/25/02