

## CC1020

### Low-Power RF Transceiver for Narrowband Systems

---

#### Applications

- *Narrowband low power UHF wireless data transmitters and receivers with channel spacing as low as 12.5 and 25 kHz*
- *402 / 424 / 426 / 429 / 433 / 447 / 449 / 469 / 868 / 915 / 960 MHz ISM/SRD band systems*
- *AMR - Automatic Meter Reading*
- *Wireless alarm and security systems*
- *Home automation*
- *Low power telemetry*

#### Product Description

**CC1020** is a true single-chip UHF transceiver designed for very low power and very low voltage wireless applications. The circuit is mainly intended for the ISM (Industrial, Scientific and Medical) and SRD (Short Range Device) frequency bands at 402, 424, 426, 429, 433, 447, 449, 469, 868, 915, and 960 MHz, but can easily be programmed for multi-channel operation at other frequencies in the 402 - 470 and 804 - 960 MHz range.

The **CC1020** is especially suited for narrow-band systems with channel spacing of 12.5 or 25 kHz complying with ARIB STD-T67 and EN 300 220.

The **CC1020** main operating parameters can be programmed via a serial bus, thus making **CC1020** a very flexible and easy to use transceiver.

In a typical system **CC1020** will be used together with a microcontroller and a few external passive components.



#### Features

- True single chip UHF RF transceiver
- Frequency range 402 MHz - 470 MHz and 804 MHz - 960 MHz
- High sensitivity (up to -118 dBm for a 12.5 kHz channel)
- Programmable output power
- Low current consumption (RX: 19.9 mA)
- Low supply voltage (2.3 V to 3.6 V)
- No external IF filter needed
- Low-IF receiver
- Very few external components required
- Small size (QFN 32 package)
- Pb-free package
- Digital RSSI and carrier sense indicator
- Data rate up to 153.6 kBaud
- OOK, FSK and GFSK data modulation
- Integrated bit synchronizer
- Image rejection mixer
- Programmable frequency and AFC make crystal temperature drift compensation possible without TCXO
- Suitable for frequency hopping systems
- Suited for systems targeting compliance with EN 300 220, FCC CFR47 part 15, ARIB STD-T67, and ARIB STD-T96
- Development kit available
- Easy-to-use software for generating the **CC1020** configuration data

## Table of Contents

|            |  |           |
|------------|--|-----------|
| <b>1.</b>  | <b>Abbreviations</b> .....   | <b>4</b>  |
| <b>2.</b>  | <b>Absolute Maximum Ratings</b> .....                                | <b>5</b>  |
| <b>3.</b>  | <b>Operating Conditions</b> .....                                    | <b>5</b>  |
| <b>4.</b>  | <b>Electrical Specifications</b> .....                               | <b>5</b>  |
| 4.1.       | RF Transmit Section .....  | 6         |
| 4.2.       | RF Receive Section .....   | 8         |
| 4.3.       | RSSI / Carrier Sense Section .....                                   | 11        |
| 4.4.       | IF Section .....   | 11        |
| 4.5.       | Crystal Oscillator Section.....                                      | 12        |
| 4.6.       | Frequency Synthesizer Section .....                                  | 13        |
| 4.7.       | Digital Inputs / Outputs.....  | 14        |
| 4.8.       | Current Consumption.....   | 15        |
| <b>5.</b>  | <b>Pin Assignment</b> .....  | <b>15</b> |
| <b>6.</b>  | <b>Circuit Description</b> .....                                     | <b>17</b> |
| <b>7.</b>  | <b>Application Circuit</b> .....                                     | <b>18</b> |
| <b>8.</b>  | <b>Configuration Overview</b> .....                                  | <b>21</b> |
| 8.1.       | Configuration Software .....   | 21        |
| <b>9.</b>  | <b>Microcontroller Interface</b> .....                               | <b>22</b> |
| 9.1.       | 4-wire Serial Configuration Interface .....                          | 23        |
| 9.2.       | Signal Interface .....   | 25        |
| <b>10.</b> | <b>Data Rate Programming</b> .....                                   | <b>27</b> |
| <b>11.</b> | <b>Frequency Programming</b> .....                                   | <b>28</b> |
| 11.1.      | Dithering .....  | 29        |
| <b>12.</b> | <b>Receiver</b> .....  | <b>30</b> |
| 12.1.      | IF Frequency .....   | 30        |
| 12.2.      | Receiver Channel Filter Bandwidth.....                               | 30        |
| 12.3.      | Demodulator, Bit Synchronizer and Data Decision.....                 | 31        |
| 12.4.      | Receiver Sensitivity versus Data Rate and Frequency Separation ..... | 32        |
| 12.5.      | RSSI .....   | 33        |
| 12.6.      | Image Rejection Calibration .....                                    | 35        |
| 12.7.      | Blocking and Selectivity .....                                       | 36        |
| 12.8.      | Linear IF Chain and AGC Settings.....                                | 37        |
| 12.9.      | AGC Settling.....  | 38        |
| 12.10.     | Preamble Length and Sync Word .....                                  | 39        |
| 12.11.     | Carrier Sense .....  | 39        |
| 12.12.     | Automatic Power-up Sequencing.....                                   | 40        |
| 12.13.     | Automatic Frequency Control.....                                     | 41        |
| 12.14.     | Digital FM .....   | 42        |

|            |  |           |
|------------|--|-----------|
| <b>13.</b> | <b>Transmitter</b> .....                                 | <b>43</b> |
| 13.1.      | FSK Modulation Formats .....                             | 43        |
| 13.2.      | Output Power Programming.....                            | 45        |
| 13.3.      | TX Data Latency.....                                     | 46        |
| 13.4.      | Reducing Spurious Emission and Modulation Bandwidth..... | 46        |
| <b>14.</b> | <b>Input / Output Matching and Filtering</b> .....       | <b>46</b> |
| <b>15.</b> | <b>Frequency Synthesizer</b> .....                       | <b>50</b> |
| 15.1.      | VCO, Charge Pump and PLL Loop Filter.....                | 50        |
| 15.2.      | VCO and PLL Self-Calibration .....                       | 51        |
| 15.3.      | PLL Turn-on Time versus Loop Filter Bandwidth.....       | 52        |
| 15.4.      | PLL Lock Time versus Loop Filter Bandwidth.....          | 53        |
| <b>16.</b> | <b>VCO and LNA Current Control</b> .....                 | <b>53</b> |
| <b>17.</b> | <b>Power Management</b> .....                            | <b>54</b> |
| <b>18.</b> | <b>On-Off Keying (OOK)</b> .....                         | <b>57</b> |
| <b>19.</b> | <b>Crystal Oscillator</b> .....                          | <b>58</b> |
| <b>20.</b> | <b>Built-in Test Pattern Generator</b> .....             | <b>59</b> |
| <b>21.</b> | <b>Interrupt on Pin DCLK</b> .....                       | <b>60</b> |
| 21.1.      | Interrupt upon PLL Lock.....                             | 60        |
| 21.2.      | Interrupt upon Received Signal Carrier Sense .....       | 60        |
| <b>22.</b> | <b>PA_EN and LNA_EN Digital Output Pins</b> .....        | <b>61</b> |
| 22.1.      | Interfacing an External LNA or PA .....                  | 61        |
| 22.2.      | General Purpose Output Control Pins.....                 | 61        |
| 22.3.      | PA_EN and LNA_EN Pin Drive.....                          | 61        |
| <b>23.</b> | <b>System Considerations and Guidelines</b> .....        | <b>62</b> |
| <b>24.</b> | <b>PCB Layout Recommendations</b> .....                  | <b>64</b> |
| <b>25.</b> | <b>Antenna Considerations</b> .....                      | <b>65</b> |
| <b>26.</b> | <b>Configuration Registers</b> .....                     | <b>65</b> |
| 26.1.      | CC1020 Register Overview.....                            | 66        |
| <b>27.</b> | <b>Package Marking</b> .....                             | <b>86</b> |
| <b>28.</b> | <b>Soldering Information</b> .....                       | <b>86</b> |
| <b>29.</b> | <b>Plastic Tube Specification</b> .....                  | <b>86</b> |
| <b>30.</b> | <b>Ordering Information</b> .....                        | <b>87</b> |
| <b>31.</b> | <b>General Information</b> .....                         | <b>88</b> |

**1. Abbreviations**

|      |                                    |
|------|------------------------------------|
| ACP  | Adjacent Channel Power             |
| ACR  | Adjacent Channel Rejection         |
| ADC  | Analog-to-Digital Converter        |
| AFC  | Automatic Frequency Control        |
| AGC  | Automatic Gain Control             |
| AMR  | Automatic Meter Reading            |
| ASK  | Amplitude Shift Keying             |
| BER  | Bit Error Rate                     |
| BOM  | Bill Of Materials                  |
| bps  | bits per second                    |
| BT   | Bandwidth-Time product (for GFSK)  |
| ChBW | Receiver Channel Filter Bandwidth  |
| CW   | Continuous Wave                    |
| DAC  | Digital-to-Analog Converter        |
| DNM  | Do Not Mount                       |
| ESR  | Equivalent Series Resistance       |
| FHSS | Frequency Hopping Spread Spectrum  |
| FM   | Frequency Modulation               |
| FS   | Frequency Synthesizer              |
| FSK  | Frequency Shift Keying             |
| GFSK | Gaussian Frequency Shift Keying    |
| IC   | Integrated Circuit                 |
| IF   | Intermediate Frequency             |
| IP3  | Third Order Intercept Point        |
| ISM  | Industrial Scientific Medical      |
| kbps | kilo bits per second               |
| LNA  | Low Noise Amplifier                |
| LO   | Local Oscillator (in receive mode) |
| MCU  | Micro Controller Unit              |
| NRZ  | Non Return to Zero                 |
| OOK  | On-Off Keying                      |
| PA   | Power Amplifier                    |
| PD   | Phase Detector / Power Down        |
| PER  | Packet Error Rate                  |
| PCB  | Printed Circuit Board              |
| PN9  | Pseudo-random Bit Sequence (9-bit) |
| PLL  | Phase Locked Loop                  |
| PSEL | Program Select                     |
| RF   | Radio Frequency                    |
| RSSI | Received Signal Strength Indicator |
| RX   | Receive (mode)                     |
| SBW  | Signal Bandwidth                   |
| SPI  | Serial Peripheral Interface        |
| SRD  | Short Range Device                 |
| TBD  | To Be Decided/Defined              |
| T/R  | Transmit/Receive (switch)          |
| TX   | Transmit (mode)                    |
| UHF  | Ultra High Frequency               |
| VCO  | Voltage Controlled Oscillator      |
| VGA  | Variable Gain Amplifier            |
| XOSC | Crystal oscillator                 |
| XTAL | Crystal                            |

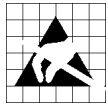
## 2. Absolute Maximum Ratings

The absolute maximum ratings given Table 1 should under no circumstances be violated. Stress exceeding one or more of the limiting values may cause permanent damage to the device.

| Parameter                 | Min  | Max              | Unit     | Condition                                  |
|---------------------------|------|------------------|----------|--|
| Supply voltage, VDD       | -0.3 | 5.0              | V        | All supply pins must have the same voltage |
| Voltage on any pin        | -0.3 | VDD+0.3, max 5.0 | V        |  |
| Input RF level            |      | 10               | dBm      |  |
| Storage temperature range | -50  | 150              | °C       |  |
| Package body temperature  |      | 260              | °C       | Norm: IPC/JEDEC J-STD-020 <sup>1</sup>     |
| Humidity non-condensing   | 5    | 85               | %        |  |
| ESD (Human Body Model)    |      | ±1<br>±0.4       | kV<br>kV | All pads except RF<br>RF Pads              |

**Table 1. Absolute maximum ratings**

<sup>1</sup> The reflow peak soldering temperature (body temperature) is specified according to IPC/JEDEC J-STD\_020“Moisture/Reflow Sensitivity Classification for Nonhermetic Solid State Surface Mount Devices”.



**Caution!** ESD sensitive device.  
Precaution should be used when handling the device in order to prevent permanent damage.

## 3. Operating Conditions

The operating conditions for **CC1020** are listed in Table 2.

| Parameter                           | Min        | Typ | Max        | Unit       | Condition / Note   |
|-------------------------------------|------------|-----|------------|------------|--|
| RF Frequency Range                  | 402<br>804 |     | 470<br>960 | MHz<br>MHz | Programmable in <300 Hz steps<br>Programmable in <600 Hz steps   |
| Operating ambient temperature range | -40        |     | 85         | °C         |  |
| Supply voltage                      | 2.3        | 3.0 | 3.6        | V          | The same supply voltage should be used for digital (DVDD) and analog (AVDD) power.<br><br>A 3.0 ±0.1 V supply is recommended to meet the ARIB STD-T67 selectivity and output power tolerance requirements. |

**Table 2. Operating conditions**

## 4. Electrical Specifications

Table 3 to Table 10 gives the **CC1020** electrical specifications. All measurements were performed using the 2 layer PCB CC1020EMX reference design. This is the same test circuit as shown in Figure 3. Temperature = 25°C, supply voltage = AVDD = DVDD = 3.0 V if nothing else stated. Crystal frequency = 14.7456 MHz.

The electrical specifications given for 868 MHz are also applicable for the 902 - 928 MHz frequency range.

## 4.1. RF Transmit Section

| Parameter  | Min    | Typ                          | Max        | Unit                         | Condition / Note  |
|--|--------|------------------------------|------------|------------------------------|---|
| Transmit data rate   | 0.45   |                              | 153.6      | kBaud                        | The data rate is programmable. See section 10 on page 27 for details.<br><br>NRZ or Manchester encoding can be used. 153.6 kBaud equals 153.6 kbps using NRZ coding and 76.8 kbps using Manchester coding. See section 9.2 on page 25 for details<br><br>Minimum data rate for OOK is 2.4 kBaud   |
| Binary FSK frequency separation  | 0<br>0 |                              | 108<br>216 | kHz<br>kHz                   | in 402 - 470 MHz range<br>in 804 - 960 MHz range<br><br>108/216 kHz is the maximum specified separation at 1.84 MHz reference frequency. Larger separations can be achieved at higher reference frequencies.  |
| Output power<br>433 MHz<br>868 MHz   |        | -20 to +10<br>-20 to +5      |            | dBm<br>dBm                   | Delivered to 50 $\Omega$ single-ended load. The output power is programmable and should not be programmed to exceed +10/+5 dBm at 433/868 MHz under any operating conditions (refer to CC1020 Errata Note 003). See section 14 on page 46 for details.  |
| Output power tolerance   |        | -4<br>+3                     |            | dB<br>dB                     | At maximum output power<br>At 2.3 V, +85°C<br>At 3.6 V, -40°C   |
| Harmonics, radiated CW<br>2 <sup>nd</sup> harmonic, 433 MHz, +10 dBm<br>3 <sup>rd</sup> harmonic, 433 MHz, +10 dBm<br><br>2 <sup>nd</sup> harmonic, 868 MHz, +5 dBm<br>3 <sup>rd</sup> harmonic, 868 MHz, +5 dBm |        | -50<br>-50<br><br>-50<br>-50 |            | dBc<br>dBc<br><br>dBc<br>dBc | Harmonics are measured as EIRP values according to EN 300 220. The antenna (SMAFF-433 and SMAFF-868 from R.W. Badland) plays a part in attenuating the harmonics.   |
| Adjacent channel power (GFSK)<br>12.5 kHz channel spacing, 433 MHz<br>25 kHz channel spacing, 433 MHz<br>25 kHz channel spacing, 868 MHz   |        | -46<br>-52<br>-49            |            | dBc<br>dBc<br>dBc            | For 12.5 kHz channel spacing ACP is measured in a $\pm 4.25$ kHz bandwidth at $\pm 12.5$ kHz offset. Modulation: 2.4 kBaud NRZ PN9 sequence, $\pm 2.025$ kHz frequency deviation.<br><br>For 25 kHz channel spacing ACP is measured in a $\pm 8.5$ kHz bandwidth at $\pm 25$ kHz offset. Modulation: 4.8 kBaud NRZ PN9 sequence, $\pm 2.475$ kHz frequency deviation. |

| Parameter  | Min | Typ                              | Max               | Unit              | Condition / Note   |
|--|-----|----------------------------------|-------------------|-------------------|--|
| Occupied bandwidth (99.5%,GFSK)<br>12.5 kHz channel spacing, 433 MHz<br>25 kHz channel spacing, 433 MHz<br>25 kHz channel spacing, 868 MHz |     | 7.5<br>9.6<br>9.6                |                   | kHz<br>kHz<br>kHz | Bandwidth for 99.5% of total average power.<br><br>Modulation for 12.5 channel spacing: 2.4 kBaud NRZ PN9 sequence, ±2.025 kHz frequency deviation.<br><br>Modulation for 25 kHz channel spacing: 4.8 kBaud NRZ PN9 sequence, ±2.475 kHz frequency deviation.  |
| Modulation bandwidth, 868 MHz<br>19.2 kBaud, ±9.9 kHz frequency deviation<br>38.4 kBaud, ±19.8 kHz frequency deviation                     |     | 48<br>106                        |                   | kHz<br>kHz        | Bandwidth where the power envelope of modulation equals -36 dBm. Spectrum analyzer RBW = 1 kHz.  |
| Spurious emission, radiated CW<br>47-74, 87.5-118,<br>174-230, 470-862 MHz<br>9 kHz - 1 GHz<br>1 - 4 GHz                                   |     |                                  | -54<br>-36<br>-30 | dBm<br>dBm<br>dBm | At maximum output power, +10/+5 dBm at 433/868 MHz.<br><br>To comply with EN 300 220, FCC CFR47 part 15, ARIB STD-T67, and ARIB STD-T96 an external (antenna) filter, as implemented in the application circuit in Figure 25, must be used and tailored to each individual design to reduce out-of-band spurious emission levels.<br><br>Spurious emissions can be measured as EIRP values according to EN 300 220. The antenna (SMAFF-433 and SMAFF-868 from R.W. Badland) plays a part in attenuating the spurious emissions.<br><br>If the output power is increased using an external PA, a filter must be used to attenuate spurs below 862 MHz when operating in the 868 MHz frequency band in Europe. Application Note AN036 CC1020/1021 Spurious Emission presents and discusses a solution that reduces the TX mode spurious emission close to 862 MHz by increasing the REF_DIV from 1 to 7. |
| Optimum load impedance<br>433 MHz<br>868 MHz<br>915 MHz  |     | 54 + j44<br>15 + j24<br>20 + j35 |                   | Ω<br>Ω<br>Ω       | Transmit mode. For matching details see section 14 on page 46.   |

**Table 3. RF transmit parameters**

4.2. RF Receive Section

| Parameter   | Min | Typ          | Max | Unit | Condition / Note   |
|---|-----|--------------|-----|------|--|
| Receiver Sensitivity, 433 MHz, FSK  |     |              |     |      | Sensitivity is measured with PN9 sequence at BER = 10 <sup>-3</sup>  |
| 12.5 kHz channel spacing, optimized selectivity, ±2.025 kHz freq. deviation |     | -114         |     | dBm  | 12.5 kHz channel spacing: 2.4 kBaud, Manchester coded data.  |
| 12.5 kHz channel spacing, optimized sensitivity, ±2.025 kHz freq. deviation |     | -118         |     | dBm  |  |
| 25 kHz channel spacing  |     | -112         |     | dBm  | 25 kHz channel spacing: 4.8 kBaud, NRZ coded data, ±2.475 kHz frequency deviation.   |
| 500 kHz channel spacing   |     | -96          |     | dBm  | 500 kHz channel spacing: 153.6 kBaud, NRZ coded data, ±72 kHz frequency deviation.   |
| Receiver Sensitivity, 868 MHz, FSK  |     |              |     |      | See Table 19 and Table 20 for typical sensitivity figures at other data rates.   |
| 12.5 kHz channel spacing, ±2.475 kHz freq. deviation                        |     | -116         |     | dBm  |  |
| 25 kHz channel spacing  |     | -111         |     | dBm  |  |
| 500 kHz channel spacing   |     | -94          |     | dBm  |  |
| Receiver sensitivity, 433 MHz, OOK  |     |              |     |      | Sensitivity is measured with PN9 sequence at BER = 10 <sup>-3</sup>  |
| 2.4 kBaud   |     | -116         |     | dBm  | Manchester coded data.   |
| 153.6 kBaud   |     | -81          |     | dBm  |  |
| Receiver sensitivity, 868 MHz, OOK  |     |              |     |      | See Table 27 for typical sensitivity figures at other data rates.  |
| 4.8 kBaud   |     | -107         |     | dBm  |  |
| 153.6 kBaud   |     | -87          |     | dBm  |  |
| Saturation (maximum input level) FSK and OOK                                |     | 10           |     | dBm  | FSK: Manchester/NRZ coded data<br>OOK: Manchester coded data<br>BER = 10 <sup>-3</sup>   |
| System noise bandwidth  |     | 9.6 to 307.2 |     | kHz  | The receiver channel filter 6 dB bandwidth is programmable from 9.6 kHz to 307.2 kHz. See section 12.2 on page 30 for details. |
| Noise figure, cascaded 433 and 868 MHz                                      |     | 7            |     | dB   | NRZ coded data   |
| Input IP3   |     |              |     |      | Two tone test (+10 MHz and +20 MHz)  |
| 433 MHz, 12.5 kHz channel spacing   |     | -23          |     | dBm  | LNA2 maximum gain  |
|   |     | -18          |     | dBm  | LNA2 medium gain   |
|   |     | -16          |     | dBm  | LNA2 minimum gain  |
| 868 MHz, 25 kHz channel spacing   |     | -18          |     | dBm  | LNA2 maximum gain  |
|   |     | -15          |     | dBm  | LNA2 medium gain   |
|   |     | -13          |     | dBm  | LNA2 minimum gain  |



| Parameter  | Min | Typ                              | Max | Unit                 | Condition / Note   |
|--|-----|----------------------------------|-----|----------------------|--|
| Co-channel rejection, FSK and OOK<br>12.5 kHz channel spacing, 433 MHz<br>25 kHz channel spacing, 433 MHz<br>25 kHz channel spacing, 868 MHz                       |     | -11<br>-11<br>-11                |     | dB<br>dB<br>dB       | Wanted signal 3 dB above the sensitivity level, FM jammer (1 kHz sine, $\pm 2.5$ kHz deviation) at operating frequency, BER = $10^{-3}$  |
| Adjacent channel rejection (ACR)<br>12.5 kHz channel spacing, 433 MHz<br>25 kHz channel spacing, 433 MHz<br>25 kHz channel spacing, 868 MHz                        |     | 32<br>37<br>32                   |     | dB<br>dB<br>dB       | Wanted signal 3 dB above the sensitivity level, FM jammer (1 kHz sine, $\pm 2.5$ kHz deviation) at adjacent channel. BER = $10^{-3}$   |
| Image channel rejection<br>433/868 MHz<br>No I/Q gain and phase calibration<br>I/Q gain and phase calibrated   |     | 26/31<br>49/52                   |     | dB<br>dB             | Wanted signal 3 dB above the sensitivity level, CW jammer at image frequency. BER = $10^{-3}$ .<br>Image rejection after calibration will depend on temperature and supply voltage. Refer to section 12.6 on page 35.  |
| Selectivity*<br>12.5 kHz channel spacing, 433 MHz<br>25 kHz channel spacing, 433 MHz<br>25 kHz channel spacing, 868 MHz<br>(*Close-in spurious response rejection) |     | 41<br>41<br>39                   |     | dB<br>dB<br>dB       | Wanted signal 3 dB above the sensitivity level. CW jammer is swept in 12.5 kHz/25 kHz steps to within $\pm 1$ MHz from wanted channel. BER = $10^{-3}$ . Adjacent channel and image channel are excluded.  |
| Blocking / Desensitization*<br>433/868 MHz<br>$\pm 1$ MHz<br>$\pm 2$ MHz<br>$\pm 5$ MHz<br>$\pm 10$ MHz<br>(*Out-of-band spurious response rejection)              |     | 50/57<br>64/71<br>64/71<br>75/78 |     | dB<br>dB<br>dB<br>dB | Wanted signal 3 dB above the sensitivity level, CW jammer at $\pm 1, 2, 5$ and $10$ MHz offset. BER = $10^{-3}$ . 12.5 kHz/25 kHz channel spacing at 433/868 MHz.<br>Complying with EN 300 220, class 2 receiver requirements.   |
| Image frequency suppression,<br>433/868 MHz<br>No I/Q gain and phase calibration<br>I/Q gain and phase calibrated  |     | 36/41<br>59/62                   |     | dB<br>dB             | Ratio between sensitivity for a signal at the image frequency to the sensitivity in the wanted channel. Image frequency is RF-2 IF. The signal source is a 2.4 kBaud, Manchester coded data, $\pm 2.025$ kHz frequency deviation, signal level for BER = $10^{-3}$       |
| Spurious reception   | 40  |                                  |     | dB                   | Ratio between sensitivity for an unwanted frequency to the sensitivity in the wanted channel. The signal source is a 2.4 kBaud, Manchester coded data, $\pm 2.025$ kHz frequency deviation, swept over all frequencies 100 MHz - 2 GHz. Signal level for BER = $10^{-3}$ |
| Intermodulation rejection (1)<br>12.5 kHz channel spacing, 433 MHz<br>25 kHz channel spacing, 868 MHz  |     | 30<br>30                         |     | dB<br>dB             | Wanted signal 3 dB above the sensitivity level, two CW jammers at +2Ch and +4Ch where Ch is channel spacing 12.5 kHz or 25 kHz. BER = $10^{-2}$  |

| Parameter   | Min | Typ                  | Max  | Unit         | Condition / Note  |
|---|-----|----------------------|------|--------------|---|
| Intermodulation rejection (2)<br>12.5 kHz channel spacing, 433 MHz<br>25 kHz channel spacing, 868 MHz |     | 56<br>55             |      | dB<br>dB     | Wanted signal 3 dB above the sensitivity level, two CW jammers at +10 MHz and +20 MHz offset. BER = 10 <sup>-2</sup>  |
| LO leakage, 433/868 MHz   |     | <-80/-66             |      | dBm          |   |
| VCO leakage   |     | -64                  |      | dBm          | VCO frequency resides between 1608 - 1880 MHz   |
| Spurious emission, radiated CW<br>9 kHz - 1 GHz<br>1 - 4 GHz  |     | <-60<br><-60         |      | dBm<br>dBm   | Complying with EN 300 220, FCC CFR47 part 15, ARIB STD-T67, and ARIB STD-T96.<br><br>Spurious emissions can be measured as EIRP values according to EN 300 220. |
| Input impedance<br>433 MHz<br>868 MHz   |     | 58 - j10<br>54 - j22 |      | Ω<br>Ω       | Receive mode. See section 14 on page 46 for details.  |
| Matched input impedance, S11<br>433 MHz<br>868 MHz  |     | -14<br>-12           |      | dB<br>dB     | Using application circuit matching network. See section 14 on page 46 for details.  |
| Matched input impedance<br>433 MHz<br>868 MHz   |     | 39 - j14<br>32 - j10 |      | Ω<br>Ω       | Using application circuit matching network. See section 14 on page 46 for details.  |
| Bit synchronization offset  |     |                      | 8000 | ppm          | The maximum bit rate offset tolerated by the bit synchronization circuit for 6 dB degradation (synchronous modes only)  |
| Data latency<br>NRZ mode<br>Manchester mode   |     | 4<br>8               |      | Baud<br>Baud | Time from clocking the data on the transmitter DIO pin until data is available on receiver DIO pin  |

**Table 4. RF receive parameters**

4.3. RSSI / Carrier Sense Section

| Parameter                            | Min | Typ | Max | Unit | Condition / Note   |
|--------------------------------------|-----|-----|-----|------|--|
| RSSI dynamic range                   |     | 55  |     | dB   | 12.5 and 25 kHz channel spacing  |
| RSSI accuracy                        |     | ± 3 |     | dB   | See section 12.5 on page 33 for details.   |
| RSSI linearity                       |     | ± 1 |     | dB   |  |
| RSSI attach time                     |     |     |     |      | Shorter RSSI attach times can be traded for lower RSSI accuracy. See section 12.5 on page 33 for details.                                      |
| 2.4 kBaud, 12.5 kHz channel spacing  |     | 3.8 |     | ms   |  |
| 4.8 kBaud, 25 kHz channel spacing    |     | 1.9 |     | ms   |  |
| 153.6 kBaud, 500 kHz channel spacing |     | 140 |     | µs   | Shorter RSSI attach times can also be traded for reduced sensitivity and selectivity by increasing the receiver channel filter bandwidth.      |
| Carrier sense programmable range     |     | 40  |     | dB   | Accuracy is as for RSSI  |
| Adjacent channel carrier sense       |     |     |     |      |  |
| 12.5 kHz channel spacing             |     | -72 |     | dBm  | At carrier sense level -110 dBm, FM jammer (1 kHz sine, ±2.5 kHz deviation) at adjacent channel.   |
| 25 kHz channel spacing               |     | -72 |     | dBm  | Adjacent channel carrier sense is measured by applying a signal on the adjacent channel and observe at which level carrier sense is indicated. |
| Spurious carrier sense               |     | -70 |     | dBm  | At carrier sense level -110 dBm, 100 MHz - 2 GHz. Adjacent channel and image channel are excluded.   |

Table 5. RSSI / Carrier sense parameters

4.4. IF Section

| Parameter                        | Min | Typ          | Max | Unit | Condition / Note  |
|----------------------------------|-----|--------------|-----|------|---|
| Intermediate frequency (IF)      |     | 307.2        |     | kHz  | See section 12.1 on page 30 for details.  |
| Digital channel filter bandwidth |     | 9.6 to 307.2 |     | kHz  | The channel filter 6 dB bandwidth is programmable from 9.6 kHz to 307.2 kHz. See section 12.2 on page 30 for details. |
| AFC resolution                   |     | 150          |     | Hz   | At 2.4 kBaud<br><br>Given as Baud rate/16. See section 12.13 on page 41 for details.                                  |

Table 6. IF section parameters

## 4.5. Crystal Oscillator Section

| Parameter  | Min            | Typ   | Max            | Unit                             | Condition / Note  |
|--|----------------|---|----------------|----------------------------------|---|
| Crystal Oscillator Frequency                                   | 4.9152         | 14.7456                                     | 19.6608        | MHz                              | Recommended frequency is 14.7456 MHz. See section 19 on page 58 for details.  |
| Reference frequency accuracy requirement                       |                | +/- 5.7<br>+/- 2.8<br><br>+/- 4             |                | ppm<br>ppm<br><br>ppm            | 433 MHz (EN 300 220)<br>868 MHz (EN 300 220)<br>Must be less than $\pm 5.7 / \pm 2.8$ ppm to comply with EN 300 220 25 kHz channel spacing at 433/868 MHz.<br><br>Must be less than $\pm 4$ ppm to comply with Japanese 12.5 kHz channel spacing regulations (ARIB STD-T67).<br><br>NOTE:<br>The reference frequency accuracy (initial tolerance) and drift (aging and temperature dependency) will determine the frequency accuracy of the transmitted signal.<br><br>Crystal oscillator temperature compensation can be done using the fine step PLL frequency programmability and the AFC feature. See section 12.13 on page 41 for details. |
| Crystal operation  |                | Parallel                                    |                |                                  | C4 and C5 are loading capacitors. See section 19 on page 58 for details.  |
| Crystal load capacitance                                       | 12<br>12<br>12 | 22<br>16<br>16                              | 30<br>30<br>16 | pF<br>pF<br>pF                   | 4.9-6 MHz, 22 pF recommended<br>6-8 MHz, 16 pF recommended<br>8-19.6 MHz, 16 pF recommended   |
| Crystal oscillator start-up time                               |                | 1.55<br>1.0<br>0.90<br>0.95<br>0.60<br>0.63 |                | ms<br>ms<br>ms<br>ms<br>ms<br>ms | 4.9152 MHz, 12 pF load<br>7.3728 MHz, 12 pF load<br>9.8304 MHz, 12 pF load<br>14.7456 MHz, 16 pF load<br>17.2032 MHz, 12 pF load<br>19.6608 MHz, 12 pF load   |
| External clock signal drive, sine wave                         |                | 300   |                | mVpp                             | The external clock signal must be connected to XOSC_Q1 using a DC block (10 nF). Set <code>XOSC_BYPASS = 0</code> in the <code>INTERFACE</code> register when using an external clock signal with low amplitude or a crystal.   |
| External clock signal drive, full-swing digital external clock |                | 0 - VDD                                     |                | V                                | The external clock signal must be connected to XOSC_Q1. No DC block shall be used. Set <code>XOSC_BYPASS = 1</code> in the <code>INTERFACE</code> register when using a full-swing digital external clock.  |

**Table 7. Crystal oscillator parameters**

4.6. Frequency Synthesizer Section

| Parameter  | Min | Typ                                 | Max | Unit   | Condition / Note  |
|--|-----|-------------------------------------|-----|--|---|
| Phase noise, 402 - 470 MHz<br>12.5 kHz channel spacing   |     | -90<br>-100<br>-105<br>-110<br>-114 |     | dBc/Hz<br>dBc/Hz<br>dBc/Hz<br>dBc/Hz<br>dBc/Hz | Unmodulated carrier<br>At 12.5 kHz offset from carrier<br>At 25 kHz offset from carrier<br>At 50 kHz offset from carrier<br>At 100 kHz offset from carrier<br>At 1 MHz offset from carrier<br><br>Measured using loop filter components given in Table 13. The phase noise will be higher for larger PLL loop filter bandwidth. |
| Phase noise, 804 - 960 MHz<br>25 kHz channel spacing   |     | -85<br>-95<br>-101<br>-109<br>-118  |     | dBc/Hz<br>dBc/Hz<br>dBc/Hz<br>dBc/Hz<br>dBc/Hz | Unmodulated carrier<br>At 12.5 kHz offset from carrier<br>At 25 kHz offset from carrier<br>At 50 kHz offset from carrier<br>At 100 kHz offset from carrier<br>At 1 MHz offset from carrier<br><br>Measured using loop filter components given in Table 13. The phase noise will be higher for larger PLL loop filter bandwidth. |
| PLL loop bandwidth<br>12.5 kHz channel spacing, 433 MHz<br>25 kHz channel spacing, 868 MHz   |     | 2.7<br>8.3                          |     | kHz<br>kHz                                     | After PLL and VCO calibration. The PLL loop bandwidth is programmable.  |
| PLL lock time (RX / TX turn time)<br>12.5 kHz channel spacing, 433 MHz<br>25 kHz channel spacing, 868 MHz<br>500 kHz channel spacing                                       |     | 900<br>640<br>14                    |     | us<br>us<br>us                                 | 307.2 kHz frequency step to RF frequency within $\pm 10\%$ of channel spacing. Depends on loop filter component values and <i>PLL_BW</i> register setting. See Table 26 on page 53 for more details.  |
| PLL turn-on time. From power down mode with crystal oscillator running.<br>12.5 kHz channel spacing, 433 MHz<br>25 kHz channel spacing, 868 MHz<br>500 kHz channel spacing |     | 3.2<br>2.5<br>700                   |     | ms<br>ms<br>us                                 | Time from writing to registers to RF frequency within $\pm 10\%$ of channel spacing. Depends on loop filter component values and <i>PLL_BW</i> register setting. See Table 25 on page 53 for more details.  |

Table 8. Frequency synthesizer parameters

4.7. Digital Inputs / Outputs

| Parameter   | Min         | Typ  | Max         | Unit   | Condition / Note   |
|---|-------------|--|-------------|--|--|
| Logic « 0 » input voltage                                       | 0           |  | 0.3*<br>VDD | V  |  |
| Logic « 1 » input voltage                                       | 0.7*<br>VDD |  | VDD         | V  |  |
| Logic « 0 » output voltage                                      | 0           |  | 0.4         | V  | Output current -2.0 mA,<br>3.0 V supply voltage  |
| Logic « 1 » output voltage                                      | 2.5         |  | VDD         | V  | Output current 2.0 mA,<br>3.0 V supply voltage   |
| Logic "0" input current   | NA          |  | -1          | μA   | Input signal equals GND.<br><br>PSEL has an internal pull-up resistor and during configuration the current will be -350 μA.  |
| Logic "1" input current   | NA          |  | 1           | μA   | Input signal equals VDD  |
| DIO setup time  | 20          |  |             | ns   | TX mode, minimum time DIO must be ready before the positive edge of DCLK. Data should be set up on the negative edge of DCLK.  |
| DIO hold time   | 10          |  |             | ns   | TX mode, minimum time DIO must be held after the positive edge of DCLK. Data should be set up on the negative edge of DCLK.  |
| Serial interface (PCLK, PDI, PDO and PSEL) timing specification |             |  |             |  | See Table 14 on page 24 for more details   |
| Pin drive, LNA_EN, PA_EN  |             | 0.90<br>0.87<br>0.81<br>0.69<br><br>0.93<br>0.92<br>0.89<br>0.79 |             | mA<br>mA<br>mA<br>mA<br><br>mA<br>mA<br>mA<br>mA | Source current<br>0 V on LNA_EN, PA_EN pins<br>0.5 V on LNA_EN, PA_EN pins<br>1.0 V on LNA_EN, PA_EN pins<br>1.5 V on LNA_EN, PA_EN pins<br><br>Sink current<br>3.0 V on LNA_EN, PA_EN pins<br>2.5 V on LNA_EN, PA_EN pins<br>2.0 V on LNA_EN, PA_EN pins<br>1.5 V on LNA_EN, PA_EN pins<br><br>See Figure 35 on page 62 for more details. |

Table 9. Digital inputs / outputs parameters

## 4.8. Current Consumption

| Parameter   | Min | Typ       | Max | Unit | Condition / Note  |
|---|-----|-----------|-----|------|---|
| Power Down mode   |     | 0.2       | 1.8 | μA   | Oscillator core off   |
| Current Consumption, receive mode 433 and 868 MHz             |     | 19.9      |     | mA   |   |
| Current Consumption, transmit mode 433/868 MHz :              |     |           |     |      |   |
| P = -20 dBm   |     | 12.3/14.5 |     | mA   | The output power is delivered to a 50 Ω single-ended load.<br>See section 13.2 on page 45 for more details. |
| P = -5 dBm  |     | 14.4/17.0 |     | mA   |   |
| P = 0 dBm   |     | 16.2/20.5 |     | mA   |   |
| P = +5 dBm  |     | 20.5/25.1 |     | mA   |   |
| P = +10 dBm (433 MHz only)                                    |     | 27.1      |     | mA   |   |
| Current Consumption, crystal oscillator                       |     | 77        |     | μA   | 14.7456 MHz, 16 pF load crystal   |
| Current Consumption, crystal oscillator and bias              |     | 500       |     | μA   | 14.7456 MHz, 16 pF load crystal   |
| Current Consumption, crystal oscillator, bias and synthesizer |     | 7.5       |     | mA   | 14.7456 MHz, 16 pF load crystal   |

Table 10. Current consumption

## 5. Pin Assignment

Table 11 provides an overview of the *CC1020* pinout.

The *CC1020* comes in a QFN32 type package.

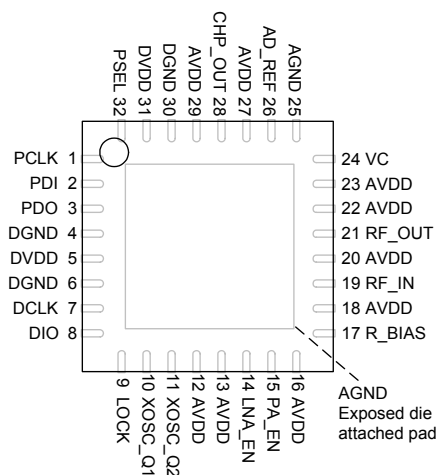


Figure 1. *CC1020* package (top view)

| Pin no. | Pin name | Pin type             | Description  |
|---------|----------|----------------------|--|
| -       | AGND     | Ground (analog)      | Exposed die attached pad. Must be soldered to a solid ground plane as this is the ground connection for all analog modules. See page 64 for more details.  |
| 1       | PCLK     | Digital input        | Programming clock for SPI configuration interface  |
| 2       | PDI      | Digital input        | Programming data input for SPI configuration interface   |
| 3       | PDO      | Digital output       | Programming data output for SPI configuration interface  |
| 4       | DGND     | Ground (digital)     | Ground connection (0 V) for digital modules and digital I/O  |
| 5       | DVDD     | Power (digital)      | Power supply (3 V typical) for digital modules and digital I/O   |
| 6       | DGND     | Ground (digital)     | Ground connection (0 V) for digital modules (substrate)  |
| 7       | DCLK     | Digital output       | Clock for data in both receive and transmit mode. Can be used as receive data output in asynchronous mode  |
| 8       | DIO      | Digital input/output | Data input in transmit mode; data output in receive mode. Can also be used to start power-up sequencing in receive   |
| 9       | LOCK     | Digital output       | PLL Lock indicator, active low. Output is asserted (low) when PLL is in lock. The pin can also be used as a general digital output, or as receive data output in synchronous NRZ/Manchester mode |
| 10      | XOSC_Q1  | Analog input         | Crystal oscillator or external clock input   |
| 11      | XOSC_Q2  | Analog output        | Crystal oscillator   |
| 12      | AVDD     | Power (analog)       | Power supply (3 V typical) for crystal oscillator  |
| 13      | AVDD     | Power (analog)       | Power supply (3 V typical) for the IF VGA  |
| 14      | LNA_EN   | Digital output       | General digital output. Can be used for controlling an external LNA if higher sensitivity is needed.   |
| 15      | PA_EN    | Digital output       | General digital output. Can be used for controlling an external PA if higher output power is needed.   |
| 16      | AVDD     | Power (analog)       | Power supply (3 V typical) for global bias generator and IF anti-alias filter  |
| 17      | R_BIAS   | Analog output        | Connection for external precision bias resistor (82 kΩ, ± 1%)  |
| 18      | AVDD     | Power (analog)       | Power supply (3 V typical) for LNA input stage   |
| 19      | RF_IN    | RF Input             | RF signal input from antenna (external AC-coupling)  |
| 20      | AVDD     | Power (analog)       | Power supply (3 V typical) for LNA   |
| 21      | RF_OUT   | RF output            | RF signal output to antenna  |
| 22      | AVDD     | Power (analog)       | Power supply (3 V typical) for LO buffers, mixers, prescaler, and first PA stage   |
| 23      | AVDD     | Power (analog)       | Power supply (3 V typical) for VCO   |
| 24      | VC       | Analog input         | VCO control voltage input from external loop filter  |
| 25      | AGND     | Ground (analog)      | Ground connection (0 V) for analog modules (guard)   |
| 26      | AD_REF   | Power (analog)       | 3 V reference input for ADC  |
| 27      | AVDD     | Power (analog)       | Power supply (3 V typical) for charge pump and phase detector  |
| 28      | CHP_OUT  | Analog output        | PLL charge pump output to external loop filter   |
| 29      | AVDD     | Power (analog)       | Power supply (3 V typical) for ADC   |
| 30      | DGND     | Ground (digital)     | Ground connection (0 V) for digital modules (guard)  |
| 31      | DVDD     | Power (digital)      | Power supply connection (3 V typical) for digital modules  |
| 32      | PSEL     | Digital input        | Programming chip select, active low, for configuration interface. Internal pull-up resistor.   |

**Table 11. Pin assignment overview**

**Note:**

DCLK, DIO and LOCK are high-impedance (3-state) in power down ( $BIAS\_PD = 1$  in the *MAIN* register).

The exposed die attached pad **must** be soldered to a solid ground plane as this is the main ground connection for the chip.



6. Circuit Description

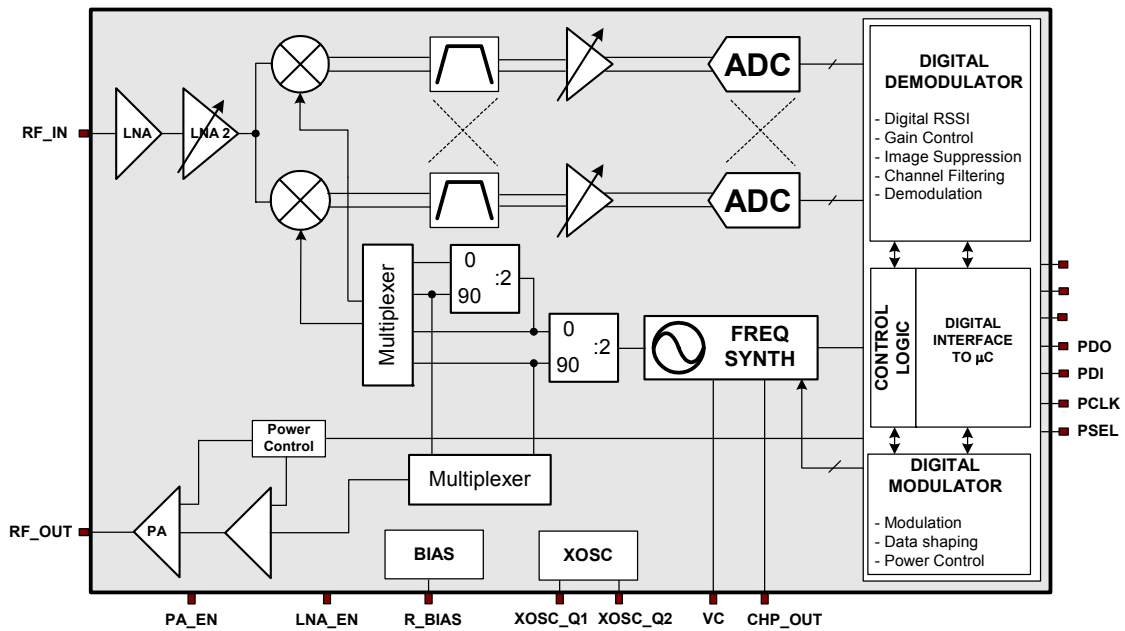


Figure 2. CC1020 simplified block diagram

A simplified block diagram of *CC1020* is shown in Figure 2. Only signal pins are shown.

*CC1020* features a low-IF receiver. The received RF signal is amplified by the low-noise amplifier (LNA and LNA2) and down-converted in quadrature (I and Q) to the intermediate frequency (IF). At IF, the I/Q signal is complex filtered and amplified, and then digitized by the ADCs. Automatic gain control, fine channel filtering, demodulation and bit synchronization is performed digitally. *CC1020* outputs the digital demodulated data on the DIO pin. A synchronized data clock is available at the DCLK pin. RSSI is available in digital format and can be read via the serial interface. The RSSI also features a programmable carrier sense indicator.

In transmit mode, the synthesized RF frequency is fed directly to the power

amplifier (PA). The RF output is frequency shift keyed (FSK) by the digital bit stream that is fed to the DIO pin. Optionally, a Gaussian filter can be used to obtain Gaussian FSK (GFSK).

The frequency synthesizer includes a completely on-chip LC VCO and a 90 degrees phase splitter for generating the LO\_I and LO\_Q signals to the down-conversion mixers in receive mode. The VCO operates in the frequency range 1.608-1.880 GHz. The CHP\_OUT pin is the charge pump output and VC is the control node of the on-chip VCO. The external loop filter is placed between these pins. A crystal is to be connected between XOSC\_Q1 and XOSC\_Q2. A lock signal is available from the PLL.

The 4-wire SPI serial interface is used for configuration.

## 7. Application Circuit

Very few external components are required for the operation of *CC1020*. The recommended application circuit is shown in Figure 3. The external components are described in Table 12 and values are given in Table 13.

### Input / output matching

L1 and C1 are the input match for the receiver. L1 is also a DC choke for biasing. L2 and C3 are used to match the transmitter to 50 Ω. Internal circuitry makes it possible to connect the input and output together and match the *CC1020* to 50 Ω in both RX and TX mode. However, it is recommended to use an external T/R switch for optimum performance. See section 14 on page 46 for details. Component values for the matching network are easily found using the SmartRF® Studio software.

### Bias resistor

The precision bias resistor R1 is used to set an accurate bias current.

### PLL loop filter

The loop filter consists of two resistors (R2 and R3) and three capacitors (C6-C8). C7 and C8 may be omitted in applications where high loop bandwidth is desired. The

values shown in Table 13 can be used for data rates up to 4.8 kBaud. Component values for higher data rates are easily found using the SmartRF® Studio software.

### Crystal

An external crystal with two loading capacitors (C4 and C5) is used for the crystal oscillator. See section 19 on page 58 for details.

### Additional filtering

Additional external components (e.g. RF LC or SAW filter) may be used in order to improve the performance in specific applications. See section 14 on page 46 for further information.

### Power supply decoupling and filtering

Power supply decoupling and filtering must be used (not shown in the application circuit). The placement and size of the decoupling capacitors and the power supply filtering are very important to achieve the optimum performance for narrowband applications. TI provides a reference design that should be followed very closely.

| Ref  | Description   |
|------|---|
| C1   | LNA input match and DC block, see page 46                             |
| C3   | PA output match and DC block, see page 46                             |
| C4   | Crystal load capacitor, see page 58                                   |
| C5   | Crystal load capacitor, see page 58                                   |
| C6   | PLL loop filter capacitor   |
| C7   | PLL loop filter capacitor (may be omitted for highest loop bandwidth) |
| C8   | PLL loop filter capacitor (may be omitted for highest loop bandwidth) |
| C60  | Decoupling capacitor  |
| L1   | LNA match and DC bias (ground), see page 46                           |
| L2   | PA match and DC bias (supply voltage), see page 46                    |
| R1   | Precision resistor for current reference generator                    |
| R2   | PLL loop filter resistor  |
| R3   | PLL loop filter resistor  |
| R10  | PA output match, see page 46  |
| XTAL | Crystal, see page 58  |

Table 12. Overview of external components (excluding supply decoupling capacitors)

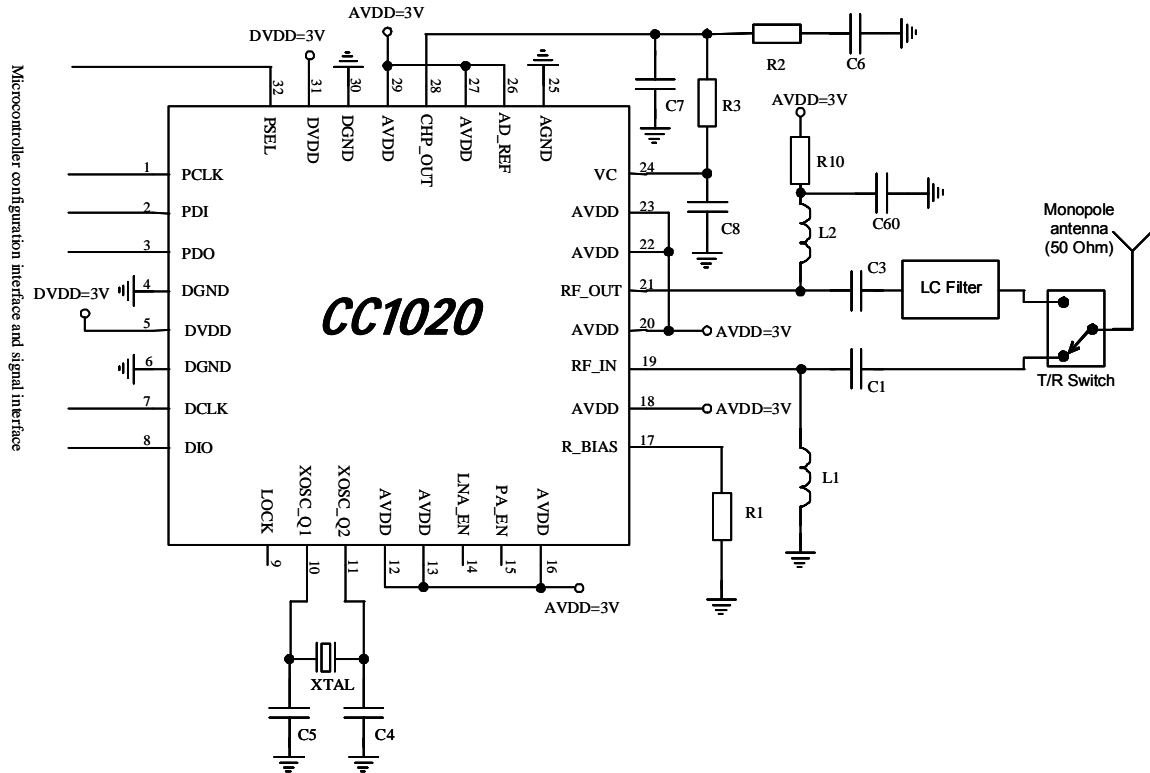


Figure 3. Typical application and test circuit (power supply decoupling not shown)

| Item | 433 MHz                            | 868 MHz                            | 915 MHz                            |
|------|------------------------------------|------------------------------------|------------------------------------|
| C1   | 10 pF, 5%, NP0, 0402               | 47 pF, 5%, NP0, 0402               | 47 pF, 5%, NP0, 0402               |
| C3   | 5.6 pF, 5%, NP0, 0402              | 10 pF, 5%, NP0, 0402               | 10 pF, 5%, NP0, 0402               |
| C4   | 22 pF, 5%, NP0, 0402               | 22 pF, 5%, NP0, 0402               | 22 pF, 5%, NP0, 0402               |
| C5   | 12 pF, 5%, NP0, 0402               | 12 pF, 5%, NP0, 0402               | 12 pF, 5%, NP0, 0402               |
| C6   | 220 nF, 10%, X7R, 0603             | 100 nF, 10%, X7R, 0603             | 100 nF, 10%, X7R, 0603             |
| C7   | 8.2 nF, 10%, X7R, 0402             | 3.9 nF, 10%, X7R, 0402             | 3.9 nF, 10%, X7R, 0402             |
| C8   | 2.2 nF, 10%, X7R, 0402             | 1.0 nF, 10%, X7R, 0402             | 1.0 nF, 10%, X7R, 0402             |
| C60  | 220 pF, 5%, NP0, 0402              | 220 pF, 5%, NP0, 0402              | 220 pF, 5%, NP0, 0402              |
| L1   | 33 nH, 5%, 0402                    | 82 nH, 5%, 0402                    | 82 nH, 5%, 0402                    |
| L2   | 22 nH, 5%, 0402                    | 3.6 nH, 5%, 0402                   | 3.6 nH, 5%, 0402                   |
| R1   | 82 k $\Omega$ , 1%, 0402           | 82 k $\Omega$ , 1%, 0402           | 82 k $\Omega$ , 1%, 0402           |
| R2   | 1.5 k $\Omega$ , 5%, 0402          | 2.2 k $\Omega$ , 5%, 0402          | 2.2 k $\Omega$ , 5%, 0402          |
| R3   | 4.7 k $\Omega$ , 5%, 0402          | 6.8 k $\Omega$ , 5%, 0402          | 6.8 k $\Omega$ , 5%, 0402          |
| R10  | 82 $\Omega$ , 5%, 0402             | 82 $\Omega$ , 5%, 0402             | 82 $\Omega$ , 5%, 0402             |
| XTAL | 14.7456 MHz crystal,<br>16 pF load | 14.7456 MHz crystal,<br>16 pF load | 14.7456 MHz crystal,<br>16 pF load |

**Note:** Items shaded vary for different frequencies. For 433 MHz, 12.5 kHz channel, a loop filter with lower bandwidth is used to improve adjacent and alternate channel rejection.

Table 13. Bill of materials for the application circuit in Figure 3

**Note:**

The PLL loop filter component values in Table 13 (R2, R3, C6-C8) can be used for data rates up to 4.8 kBaud. The SmartRF® Studio software provides component values for other data rates using the equations on page 50.

In the CC1020EMX reference design LQG15HS series inductors from Murata have been used. The switch is SW-456 from M/A-COM.

The LC filter in Figure 3 is inserted in the TX path only. The filter will reduce the emission of harmonics and the spurious emissions in the TX path. An alternative is to insert the LC filter between the antenna and the T/R switch as shown in Figure 4.

The filter will reduce the emission of harmonics and the spurious emissions in the TX path as well as increase the receiver selectivity. The sensitivity will be slightly reduced due to the insertion loss of the LC filter.

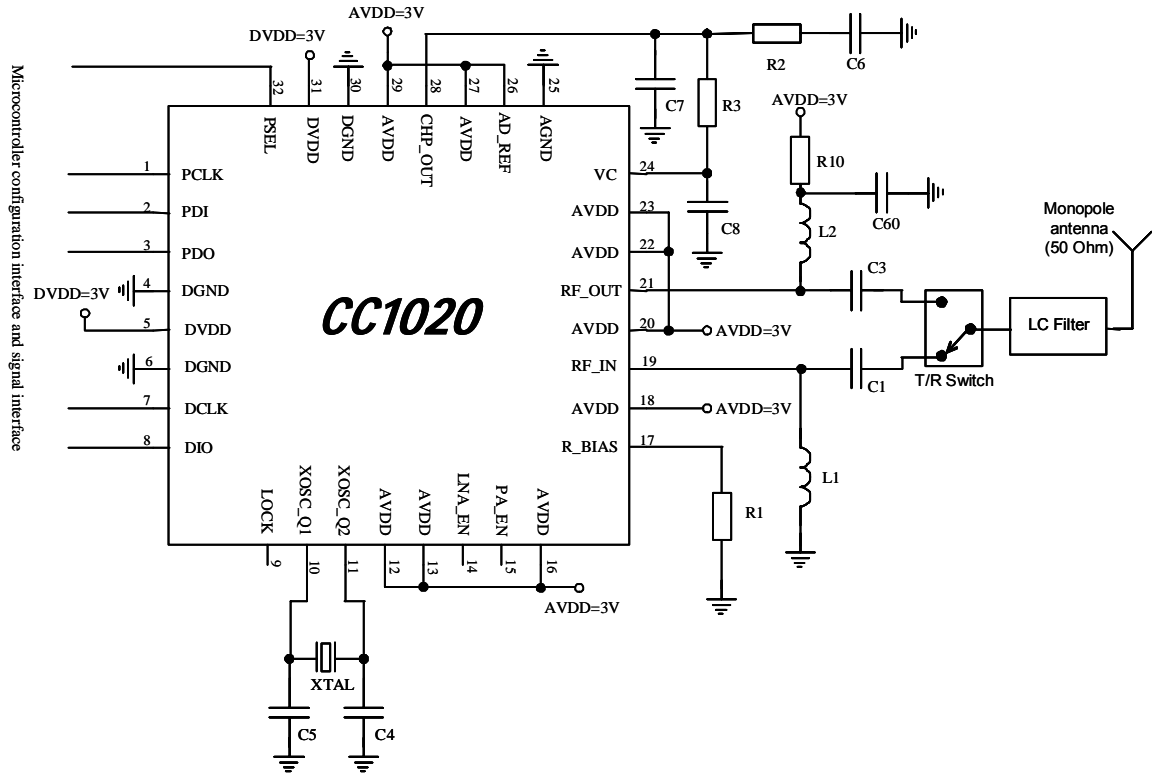


Figure 4. Alternative application circuit (power supply decoupling not shown)

## 8. Configuration Overview

CC1020 can be configured to achieve optimum performance for different applications. Through the programmable configuration registers the following key parameters can be programmed:

- Receive / transmit mode
- RF output power
- Frequency synthesizer key parameters:  
RF output frequency, FSK frequency

separation, crystal oscillator reference frequency

- Power-down / power-up mode
- Crystal oscillator power-up / power-down
- Data rate and data format (NRZ, Manchester coded or UART interface)
- Synthesizer lock indicator mode
- Digital RSSI and carrier sense
- FSK / GFSK / OOK modulation

### 8.1. Configuration Software

TI provides users of CC1020 with a software program, SmartRF® Studio (Windows interface) that generates all necessary CC1020 configuration data based on the user's selections of various parameters. These hexadecimal numbers will then be the necessary input to the microcontroller for the configuration of

CC1020. In addition, the program will provide the user with the component values needed for the input/output matching circuit, the PLL loop filter and the LC filter.

Figure 5 shows the user interface of the CC1020 configuration software.

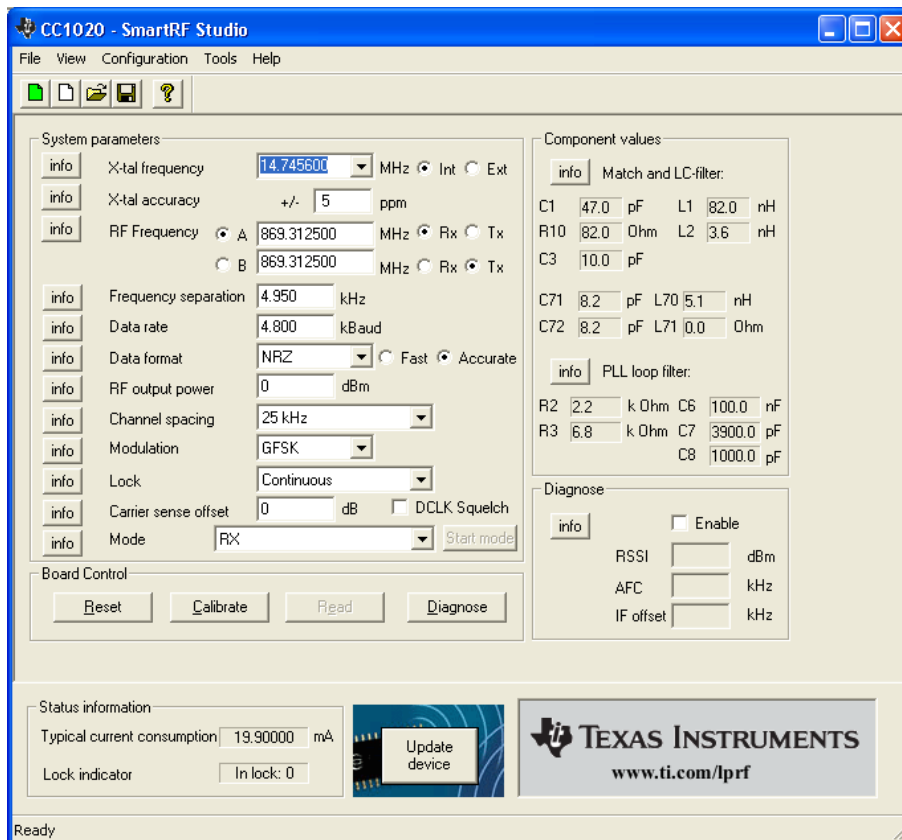


Figure 5. SmartRF® Studio user interface

## 9. Microcontroller Interface

Used in a typical system, *CC1020* will interface to a microcontroller. This microcontroller must be able to:

- Program *CC1020* into different modes via the 4-wire serial configuration interface (PDI, PDO, PCLK and PSEL)
- Interface to the bi-directional synchronous data signal interface (DIO and DCLK)
- Optionally, the microcontroller can do data encoding / decoding
- Optionally, the microcontroller can monitor the LOCK pin for frequency lock status, carrier sense status or other status information.
- Optionally, the microcontroller can read back the digital RSSI value and other status information via the 4-wire serial interface

### Configuration interface

The microcontroller interface is shown in Figure 6. The microcontroller uses 3 or 4 I/O pins for the configuration interface (PDI, PDO, PCLK and PSEL). PDO should be connected to a microcontroller input. PDI, PCLK and PSEL must be microcontroller outputs. One I/O pin can be saved if PDI and PDO are connected together and a bi-directional pin is used at the microcontroller.

The microcontroller pins connected to PDI, PDO and PCLK can be used for other purposes when the configuration interface is not used. PDI, PDO and PCLK are high impedance inputs as long as PSEL is not activated (active low).

PSEL has an internal pull-up resistor and should be left open (tri-stated by the microcontroller) or set to a high level during power down mode in order to prevent a trickle current flowing in the pull-up.

### Signal interface

A bi-directional pin is usually used for data (DIO) to be transmitted and data received. DCLK providing the data timing should be connected to a microcontroller input.

As an option, the data output in receive mode can be made available on a separate pin. See section 9.2 on page for 25 further details.

### PLL lock signal

Optionally, one microcontroller pin can be used to monitor the LOCK signal. This signal is at low logic level when the PLL is in lock. It can also be used for carrier sense and to monitor other internal test signals.

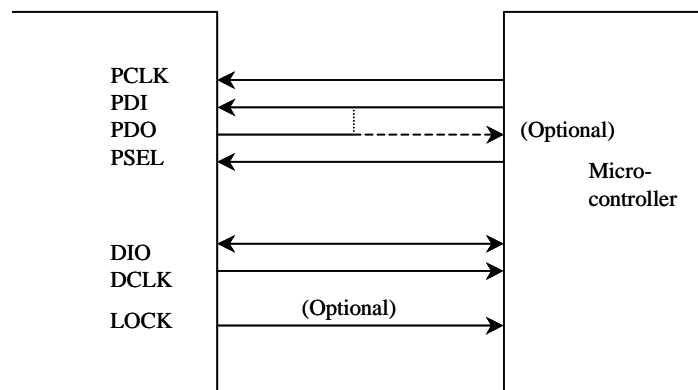


Figure 6. Microcontroller interface

## 9.1. 4-wire Serial Configuration Interface

CC1020 is configured via a simple 4-wire SPI-compatible interface (PDI, PDO, PCLK and PSEL) where CC1020 is the slave. There are 8-bit configuration registers, each addressed by a 7-bit address. A Read/Write bit initiates a read or write operation. A full configuration of CC1020 requires sending 33 data frames of 16 bits each (7 address bits, R/W bit and 8 data bits). The time needed for a full configuration depends on the PCLK frequency. With a PCLK frequency of 10 MHz the full configuration is done in less than 53  $\mu$ s. Setting the device in power down mode requires sending one frame only and will in this case take less than 2  $\mu$ s. All registers are also readable.

During each write-cycle, 16 bits are sent on the PDI-line. The seven most significant bits of each data frame (A6:0) are the address-bits. A6 is the MSB (Most Significant Bit) of the address and is sent as the first bit. The next bit is the R/W bit (high for write, low for read). The 8 data-bits are then transferred (D7:0). During address and data transfer the PSEL (Program SElect) must be kept low. See Figure 7.

The timing for the programming is also shown in Figure 7 with reference to Table

14. The clocking of the data on PDI is done on the positive edge of PCLK. Data should be set up on the negative edge of PCLK by the microcontroller. When the last bit, D0, of the 8 data-bits has been loaded, the data word is loaded into the internal configuration register.

The configuration data will be retained during a programmed power down mode, but not when the power supply is turned off. The registers can be programmed in any order.

The configuration registers can also be read by the microcontroller via the same configuration interface. The seven address bits are sent first, then the R/W bit set low to initiate the data read-back. CC1020 then returns the data from the addressed register. PDO is used as the data output and must be configured as an input by the microcontroller. The PDO is set at the negative edge of PCLK and should be sampled at the positive edge. The read operation is illustrated in Figure 8.

PSEL must be set high between each read/write operation.

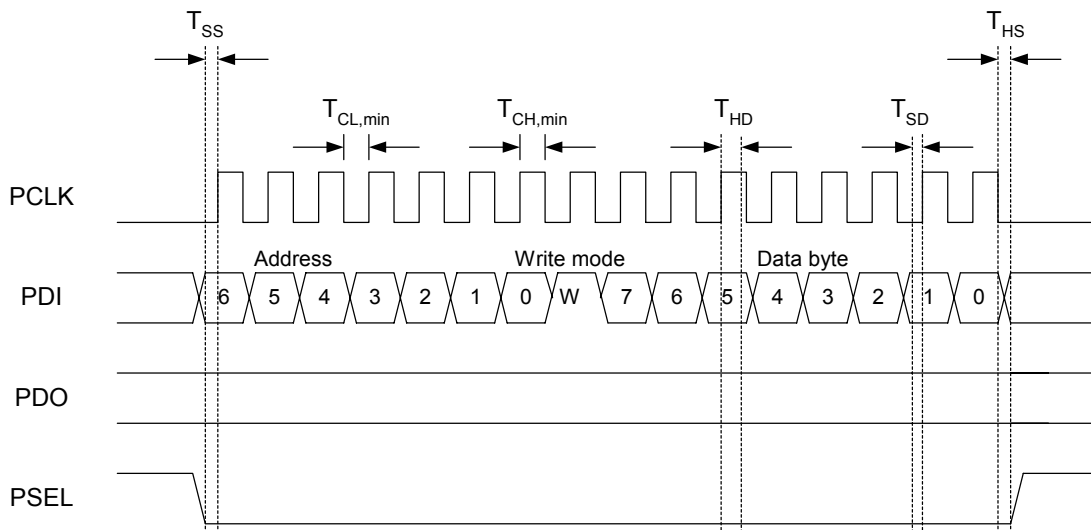


Figure 7. Configuration registers write operation

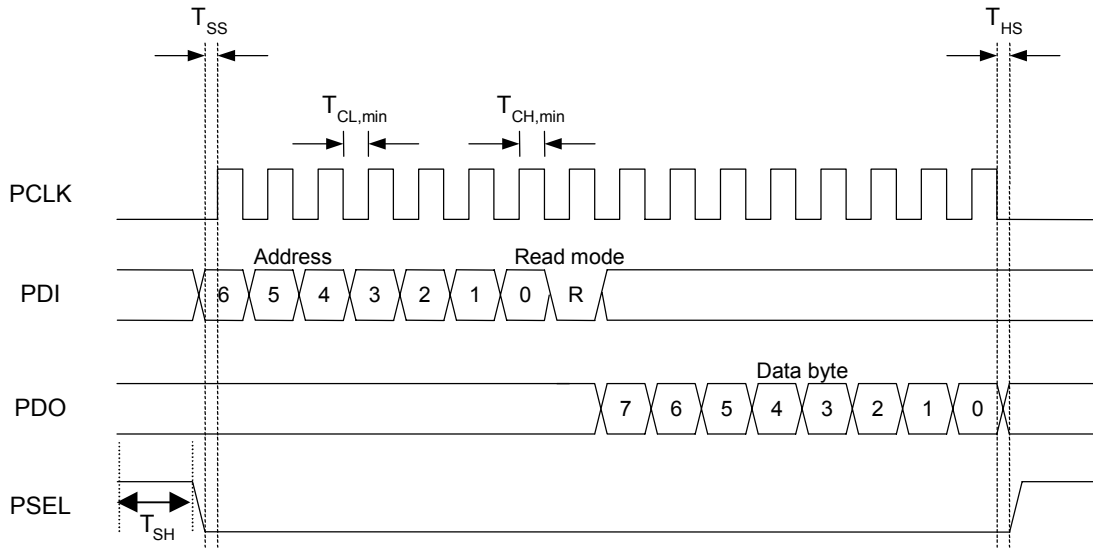


Figure 8. Configuration registers read operation

| Parameter                | Symbol       | Min | Max | Unit | Conditions  |
|--------------------------|--------------|-----|-----|------|---|
| PCLK, clock frequency    | $F_{PCLK}$   |     | 10  | MHz  |   |
| PCLK low pulse duration  | $T_{CL,min}$ | 50  |     | ns   | The minimum time PCLK must be low.  |
| PCLK high pulse duration | $T_{CH,min}$ | 50  |     | ns   | The minimum time PCLK must be high.   |
| PSEL setup time          | $T_{SS}$     | 25  |     | ns   | The minimum time PSEL must be low before <i>positive</i> edge of PCLK.              |
| PSEL hold time           | $T_{HS}$     | 25  |     | ns   | The minimum time PSEL must be held low after the <i>negative</i> edge of PCLK.      |
| PSEL high time           | $T_{SH}$     | 50  |     | ns   | The minimum time PSEL must be high.   |
| PDI setup time           | $T_{SD}$     | 25  |     | ns   | The minimum time data on PDI must be ready before the <i>positive</i> edge of PCLK. |
| PDI hold time            | $T_{HD}$     | 25  |     | ns   | The minimum time data must be held at PDI, after the <i>positive</i> edge of PCLK.  |
| Rise time                | $T_{rise}$   |     | 100 | ns   | The maximum rise time for PCLK and PSEL   |
| Fall time                | $T_{fall}$   |     | 100 | ns   | The maximum fall time for PCLK and PSEL   |

**Note:** The setup and hold times refer to 50% of VDD. The rise and fall times refer to 10% / 90% of VDD. The maximum load that this table is valid for is 20 pF.

Table 14. Serial interface, timing specification



## 9.2. Signal Interface

The **CC1020** can be used with NRZ (Non-Return-to-Zero) data or Manchester (also known as bi-phase-level) encoded data. **CC1020** can also synchronize the data from the demodulator and provide the data clock at DCLK. The data format is controlled by the *DATA\_FORMAT[1:0]* bits in the *MODEM* register.

**CC1020** can be configured for three different data formats:

### Synchronous NRZ mode

In transmit mode **CC1020** provides the data clock at DCLK and DIO is used as data input. Data is clocked into **CC1020** at the rising edge of DCLK. The data is modulated at RF without encoding.

In receive mode **CC1020** performs the synchronization and provides received data clock at DCLK and data at DIO. The data should be clocked into the interfacing circuit at the rising edge of DCLK. See Figure 9.

### Synchronous Manchester encoded mode

In transmit mode **CC1020** provides the data clock at DCLK and DIO is used as data input. Data is clocked into **CC1020** at the rising edge of DCLK and should be in NRZ format. The data is modulated at RF with Manchester code. The encoding is done by **CC1020**. In this mode the effective bit rate is half the baud rate due to the coding. As an example, 4.8 kBaud Manchester encoded data corresponds to 2.4 kbps.

In receive mode **CC1020** performs the synchronization and provides received data clock at DCLK and data at DIO. **CC1020** performs the decoding and NRZ data is presented at DIO. The data should be clocked into the interfacing circuit at the rising edge of DCLK. See Figure 10.

In synchronous NRZ or Manchester mode the DCLK signal runs continuously both in RX and TX unless the DCLK signal is gated with the carrier sense signal or the PLL lock signal. Refer to section 21 and section 21.2 for more details.

If *SEP\_DI\_DO* = 0 in the *INTERFACE* register, the DIO pin is the data output in receive mode and data input in transmit mode.

As an option, the data output can be made available at a separate pin. This is done by setting *SEP\_DI\_DO* = 1 in the *INTERFACE* register. Then, the LOCK pin will be used as data output in synchronous mode, overriding other use of the LOCK pin.

### Transparent Asynchronous UART mode

In transmit mode DIO is used as data input. The data is modulated at RF without synchronization or encoding.

In receive mode the raw data signal from the demodulator is sent to the output (DIO). No synchronization or decoding of the signal is done in **CC1020** and should be done by the interfacing circuit.

If *SEP\_DI\_DO* = 0 in the *INTERFACE* register, the DIO pin is the data output in receive mode and data input in transmit mode. The DCLK pin is not active and can be set to a high or low level by *DATA\_FORMAT[0]*.

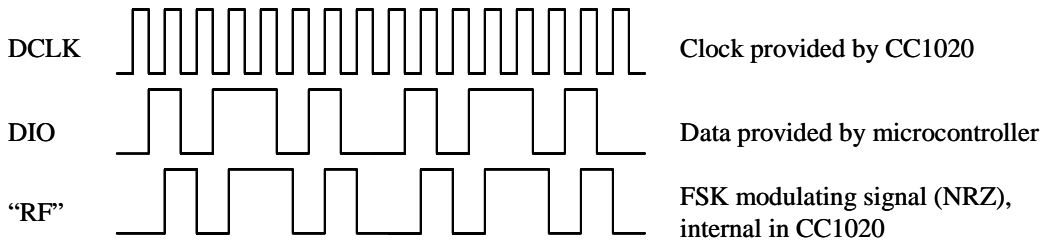
If *SEP\_DI\_DO* = 1 in the *INTERFACE* register, the DCLK pin is the data output in receive mode and the DIO pin is the data input in transmit mode. In TX mode the DCLK pin is not active and can be set to a high or low level by *DATA\_FORMAT[0]*. See Figure 11.

### Manchester encoding and decoding

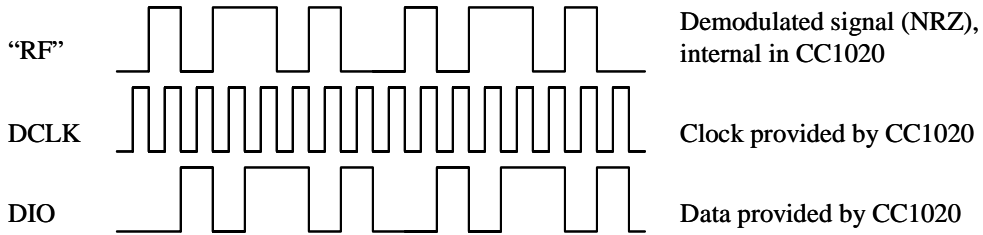
In the *Synchronous Manchester encoded mode* **CC1020** uses Manchester coding when modulating the data. The **CC1020** also performs the data decoding and synchronization. The Manchester code is based on transitions; a "0" is encoded as a low-to-high transition, a "1" is encoded as a high-to-low transition. See Figure 12.

The Manchester code ensures that the signal has a constant DC component, which is necessary in some FSK demodulators. Using this mode also ensures compatibility with CC400/CC900 designs.

**Transmitter side:**

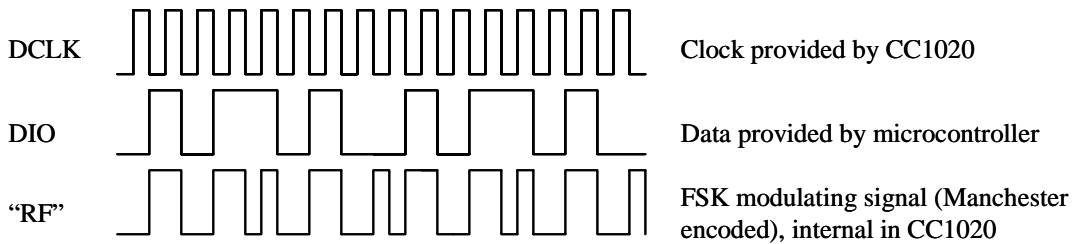


**Receiver side:**

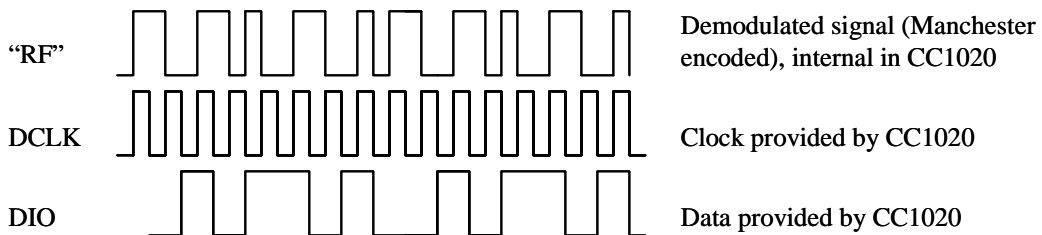


**Figure 9. Synchronous NRZ mode ( $SEP\_DI\_DO = 0$ )**

**Transmitter side:**

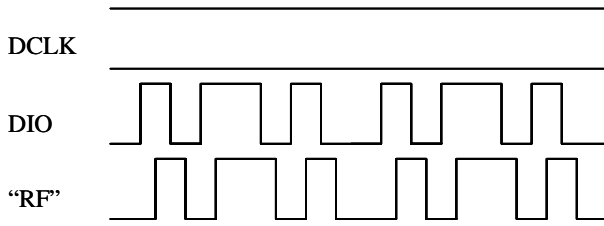


**Receiver side:**



**Figure 10. Synchronous Manchester encoded mode ( $SEP\_DI\_DO = 0$ )**

**Transmitter side:**

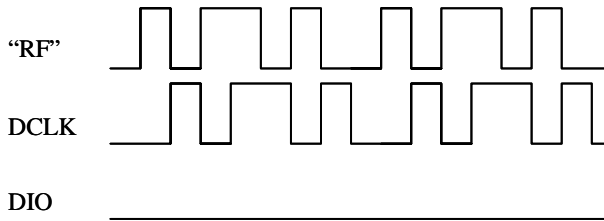


DCLK is not used in transmit mode, and is used as data output in receive mode. It can be set to default high or low in transmit mode.

Data provided by UART (TXD)

FSK modulating signal, internal in CC1020

**Receiver side:**

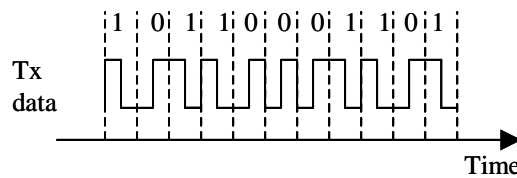


Demodulated signal (NRZ), internal in CC1020

DCLK is used as data output provided by CC1020. Connect to UART (RXD)

DIO is not used in receive mode. Used only as data input in transmit mode

**Figure 11. Transparent Asynchronous UART mode (*SEP\_DI\_DO* = 1)**



**Figure 12. Manchester encoding**

## 10. Data Rate Programming

The data rate (baud rate) is programmable and depends on the crystal frequency and the programming of the *CLOCK* (*CLOCK\_A* and *CLOCK\_B*) registers.

The baud rate (B.R) is given by

$$B.R. = \frac{f_{xosc}}{8 \cdot (REF\_DIV + 1) \cdot DIV1 \cdot DIV2}$$

where DIV1 and DIV2 are given by the value of *MCLK\_DIV1* and *MCLK\_DIV2*.

Table 17 shows some possible data rates as a function of crystal frequency in synchronous mode. In asynchronous transparent UART mode any data rate up to 153.6 kBaud can be used.

| MCLK_DIV2[1:0] | DIV2 |
|----------------|------|
| 00             | 1    |
| 01             | 2    |
| 10             | 4    |
| 11             | 8    |

**Table 15. DIV2 for different settings of MCLK\_DIV2**

| MCLK_DIV1[2:0] | DIV1 |
|----------------|------|
| 000            | 2.5  |
| 001            | 3    |
| 010            | 4    |
| 011            | 7.5  |
| 100            | 12.5 |
| 101            | 40   |
| 110            | 48   |
| 111            | 64   |

**Table 16. DIV1 for different settings of MCLK\_DIV1**

| Data rate [kBaud] | Crystal frequency [MHz] |        |        |        |         |         |         |
|-------------------|-------------------------|--------|--------|--------|---------|---------|---------|
|                   | 4.9152                  | 7.3728 | 9.8304 | 12.288 | 14.7456 | 17.2032 | 19.6608 |
| 0.45              |                         | X      |        |        | X       |         |         |
| 0.5               |                         |        |        | X      |         |         |         |
| 0.6               | X                       | X      | X      | X      | X       | X       | X       |
| 0.9               |                         | X      |        |        | X       |         |         |
| 1                 |                         |        |        | X      |         |         |         |
| 1.2               | X                       | X      | X      | X      | X       | X       | X       |
| 1.8               |                         | X      |        |        | X       |         |         |
| 2                 |                         |        |        | X      |         |         |         |
| 2.4               | X                       | X      | X      | X      | X       | X       | X       |
| 3.6               |                         | X      |        |        | X       |         |         |
| 4                 |                         |        |        | X      |         |         |         |
| 4.096             |                         |        | X      |        |         |         | X       |
| 4.8               | X                       | X      | X      | X      | X       | X       | X       |
| 7.2               |                         | X      |        |        | X       |         |         |
| 8                 |                         |        |        | X      |         |         |         |
| 8.192             |                         |        | X      |        |         |         | X       |
| 9.6               | X                       | X      | X      | X      | X       | X       | X       |
| 14.4              |                         | X      |        |        | X       |         |         |
| 16                |                         |        |        | X      |         |         |         |
| 16.384            |                         |        | X      |        |         |         | X       |
| 19.2              | X                       | X      | X      | X      | X       | X       | X       |
| 28.8              |                         | X      |        |        | X       |         |         |
| 32                |                         |        |        | X      |         |         |         |
| 32.768            |                         |        | X      |        |         |         | X       |
| 38.4              | X                       | X      | X      | X      | X       | X       | X       |
| 57.6              |                         | X      |        |        | X       |         |         |
| 64                |                         |        |        | X      |         |         |         |
| 65.536            |                         |        |        |        |         |         | X       |
| 76.8              | X                       | X      | X      | X      | X       | X       | X       |
| 115.2             |                         | X      |        |        | X       |         |         |
| 128               |                         |        |        | X      |         |         |         |
| 153.6             |                         | X      |        | X      | X       | X       | X       |

Table 17. Some possible data rates versus crystal frequency

## 11. Frequency Programming

Programming the frequency word in the configuration registers sets the operation frequency. There are two frequency words registers, termed *FREQ\_A* and *FREQ\_B*, which can be programmed to two different frequencies. One of the frequency words can be used for RX (local oscillator frequency) and the other for TX (transmitting carrier frequency) in order to be able to switch very fast between RX mode and TX mode. They can also be used for RX (or TX) at two different channels. The *F\_REG* bit in the *MAIN* register selects frequency word A or B.

The frequency word is located in *FREQ\_2A:FREQ\_1A:FREQ\_0A* and *FREQ\_2B:FREQ\_1B:FREQ\_0B* for the *FREQ\_A* and *FREQ\_B* word respectively. The LSB of the *FREQ\_0* registers are used to enable dithering, section 11.1.

The PLL output frequency is given by:

$$f_c = f_{ref} \cdot \left( \frac{3}{4} + \frac{FREQ + 0.5 \cdot DITHER}{32768} \right)$$

in the frequency band 402 – 470 MHz, and

$$f_c = f_{ref} \cdot \left( \frac{3}{2} + \frac{FREQ + 0.5 \cdot DITHER}{16384} \right)$$

in the frequency band 804 – 960 MHz.

The *BANDSELECT* bit in the *ANALOG* register controls the frequency band used. *BANDSELECT* = 0 gives 402 – 470 MHz, and *BANDSELECT* = 1 gives 804 – 960 MHz.

The reference frequency is the crystal oscillator clock frequency divided by *REF\_DIV* (3 bits in the *CLOCK\_A* or

CLOCK\_B register), a number between 1 and 7:

$$f_{ref} = \frac{f_{xosc}}{REF\_DIV + 1}$$

FSK frequency deviation is programmed in the *DEVIATION* register. The deviation programming is divided into a mantissa (*TXDEV\_M[3:0]*) and an exponent (*TXDEV\_X[2:0]*).

Generally *REF\_DIV* should be as low as possible but the following requirements must be met

$$9.8304 \geq f_{ref} > \frac{f_c}{256} [MHz]$$

in the frequency band 402 – 470 MHz, and

$$9.8304 \geq f_{ref} > \frac{f_c}{512} [MHz]$$

in the frequency band 804 – 960 MHz.

The PLL output frequency equations above give the carrier frequency,  $f_c$ , in transmit mode (centre frequency). The two FSK modulation frequencies are given by:

$$f_0 = f_c - f_{dev}$$

$$f_1 = f_c + f_{dev}$$

where  $f_{dev}$  is set by the *DEVIATION* register:

$$f_{dev} = f_{ref} \cdot TXDEV\_M \cdot 2^{(TXDEV\_X-16)}$$

in the frequency band 402 – 470 MHz and

$$f_{dev} = f_{ref} \cdot TXDEV\_M \cdot 2^{(TXDEV\_X-15)}$$

in the frequency band 804 – 960 MHz.

OOK (On-Off Keying) is used if *TXDEV\_M[3:0]* = 0000.

The *TX\_SHAPING* bit in the *DEVIATION* register controls Gaussian shaping of the modulation signal.

In receive mode the frequency must be programmed to be the LO frequency. Low side LO injection is used, hence:

$$f_{LO} = f_c - f_{IF}$$

where  $f_{IF}$  is the IF frequency (ideally 307.2 kHz).

## 11.1. Dithering

Spurious signals will occur at certain frequencies depending on the division ratios in the PLL. To reduce the strength of these spurs, a common technique is to use a dithering signal in the control of the

frequency dividers. Dithering is activated by setting the *DITHER* bit in the *FREQ\_0* registers. It is recommended to use the dithering in order to achieve the best possible performance.

## 12. Receiver

### 12.1. IF Frequency

The IF frequency is derived from the crystal frequency as

$$f_{IF} = \frac{f_{XOSC}}{8 \cdot (ADC\_DIV[2:0] + 1)}$$

where *ADC\_DIV[2:0]* is set in the *MODEM* register.

The analog filter succeeding the mixer is used for wideband and anti-alias filtering which is important for the blocking performance at 1 MHz and larger offsets. This filter is fixed and centered on the nominal IF frequency of 307.2 kHz. The bandwidth of the analog filter is about 160 kHz.

Using crystal frequencies which gives an IF frequency within 300 – 320 kHz means that the analog filter can be used (assuming low frequency deviations and low data rates).

Large offsets, however, from the nominal IF frequency will give an un-symmetric filtering (variation in group delay and different attenuation) of the signal, resulting in decreased sensitivity and selectivity. See Application Note AN022 *Crystal Frequency Selection* for more details.

For IF frequencies other than 300 – 320 kHz and for high frequency deviation and high data rates (typically  $\geq 76.8$  kBaud) the analog filter must be bypassed by setting *FILTER\_BYPASS* = 1 in the *FILTER* register. In this case the blocking performance at 1 MHz and larger offsets will be degraded.

The IF frequency is always the ADC clock frequency divided by 4. The ADC clock frequency should therefore be as close to 1.2288 MHz as possible.

### 12.2. Receiver Channel Filter Bandwidth

In order to meet different channel spacing requirements, the receiver channel filter bandwidth is programmable. It can be programmed from 9.6 to 307.2 kHz.

The minimum receiver channel filter bandwidth depends on baud rate, frequency separation and crystal tolerance.

The signal bandwidth must be smaller than the available receiver channel filter bandwidth. The signal bandwidth (SBW) can be approximated by (Carson's rule):

$$SBW = 2 \cdot f_m + 2 \cdot \text{frequency deviation}$$

where *f<sub>m</sub>* is the modulating signal. In Manchester mode the maximum modulating signal occurs when transmitting a continuous sequence of 0's (or 1's). In NRZ mode the maximum modulating signal occurs when transmitting a 0-1-0 sequence. In both Manchester and NRZ mode 2·*f<sub>m</sub>* is then

equal to the programmed baud rate. The equation for SBW can then be rewritten as

$$SBW = \text{Baud rate} + \text{frequency separation}$$

Furthermore, the frequency offset of the transmitter and receiver must also be considered. Assuming equal frequency error in the transmitter and receiver (same type of crystal) the total frequency error is:

$$f\_error = \pm 2 \cdot XTAL\_ppm \cdot f\_RF$$

where *XTAL\_ppm* is the total accuracy of the crystal including initial tolerance, temperature drift, loading and ageing. *F<sub>RF</sub>* is the RF operating frequency.

The minimum receiver channel filter bandwidth (ChBW) can then be estimated as

$$ChBW > SBW + 2 \cdot f\_error$$

The *DEC\_DIV[4:0]* bits in the *FILTER* register control the receiver channel filter

bandwidth. The 6 dB bandwidth is given by:

$$\text{ChBW} = 307.2 / (\text{DEC\_DIV} + 1) \text{ [kHz]}$$

where the IF frequency is set to 307.2 kHz.

In SmartRF® Studio the user specifies the channel spacing and the channel filter bandwidth is set according to Table 18.

For narrowband systems with channel spacings of 12.5 and 25 kHz the channel filter bandwidth is 12.288 kHz and 19.2 kHz respectively to comply with ARIB STD-T67 and EN 300 220.

For wideband systems (channel spacing of 50 kHz and above) it is possible to use different channel filter bandwidths than given in Table 18.

There is a trade-off between selectivity as well as sensitivity and accepted frequency tolerance. In applications where larger frequency drift is expected, the filter bandwidth can be increased, but with reduced adjacent channel rejection (ACR) and sensitivity.

| Channel spacing [kHz] | Filter bandwidth [kHz] | FILTER.DEC_DIV [4:0] [decimal(binary)] |
|-----------------------|------------------------|--|
| 12.5                  | 12.288                 | 24 (11000b)                            |
| 25                    | 19.2                   | 15 (01111b)                            |
| 50                    | 25.6                   | 11 (01011b)                            |
| 100                   | 51.2                   | 5 (00101b)                             |
| 150                   | 102.4                  | 2 (00010b)                             |
| 200                   | 153.6                  | 1 (00001b)                             |
| 500                   | 307.2                  | 0 (00000b)                             |

**Table 18. Channel filter bandwidths used for the channel spacings defined in SmartRF® Studio**

### 12.3. Demodulator, Bit Synchronizer and Data Decision

The block diagram for the demodulator, data slicer and bit synchronizer is shown in Figure 13. The built-in bit synchronizer synchronizes the internal clock to the incoming data and performs data decoding. The data decision is done using over-sampling and digital filtering of the incoming signal. This improves the reliability of the data transmission. Using the synchronous modes simplifies the data-decoding task substantially.

The recommended preamble is a '010101...' bit pattern. The same bit pattern should also be used in Manchester mode, giving a '011001100110...' chip pattern. This is necessary for the bit synchronizer to synchronize to the coding correctly.

The data slicer does the bit decision. Ideally the two received FSK frequencies are placed symmetrically around the IF frequency. However, if there is some frequency error between the transmitter and the receiver, the bit decision level should be adjusted accordingly. In **CC1020** this is done automatically by measuring the two frequencies and use the average value as the decision level.

The digital data slicer in **CC1020** uses an average value of the minimum and

maximum frequency deviation detected as the comparison level. The *RXDEV\_X[1:0]* and *RXDEV\_M[3:0]* in the *AFC\_CONTROL* register are used to set the expected deviation of the incoming signal. Once a shift in the received frequency larger than the expected deviation is detected, a bit transition is recorded and the average value to be used by the data slicer is calculated.

The minimum number of transitions required to calculate a slicing level is 3. That is, a 010 bit pattern (NRZ).

The actual number of bits used for the averaging can be increased for better data decision accuracy. This is controlled by the *SETTLING[1:0]* bits in the *AFC\_CONTROL* register. If RX data is present in the channel when the RX chain is turned on, then the data slicing estimate will usually give correct results after 3 bit transitions. The data slicing accuracy will increase after this, depending on the *SETTLING[1:0]* bits. If the start of transmission occurs after the RX chain has turned on, the minimum number of bit transitions (or preamble bits) before correct data slicing will depend on the *SETTLING[1:0]* bits.

The automatic data slicer average value function can be disabled by setting *SETTLING[1:0]* = 00. In this case a symmetrical signal around the IF frequency is assumed.

The internally calculated average FSK frequency value gives a measure for the frequency offset of the receiver compared to the transmitter. This information can also be used for an automatic frequency control (AFC) as described in section 12.13.

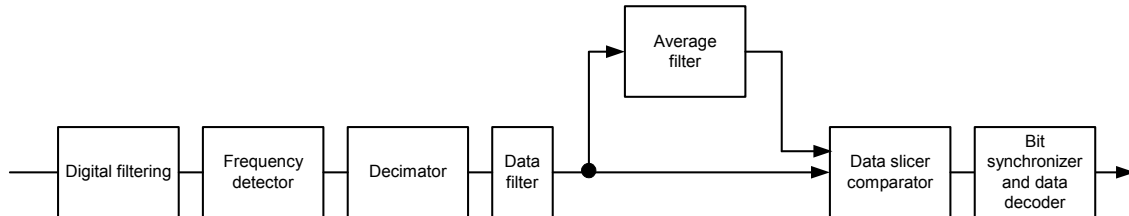


Figure 13. Demodulator block diagram

### 12.4. Receiver Sensitivity versus Data Rate and Frequency Separation

The receiver sensitivity depends on the channel filter bandwidth, data rate, data format, FSK frequency separation and the RF frequency. Typical figures for the receiver sensitivity (BER =  $10^{-3}$ ) are shown in Table 19 and Table 20 for FSK. For best performance, the frequency deviation should be at least half the baud rate in FSK mode.

The sensitivity is measured using the matching network shown in the application circuit in Figure 3, which includes an external T/R switch.

Refer to Application Note AN029 CC1020/1021 AFC for plots of sensitivity versus frequency offset.

| Data rate [kBaud]         | Channel spacing [kHz] | Deviation [kHz] | Filter BW [kHz] | Sensitivity [dBm] |                 |           |
|---------------------------|-----------------------|-----------------|-----------------|-------------------|-----------------|-----------|
|                           |                       |                 |                 | NRZ mode          | Manchester mode | UART mode |
| 2.4 optimized sensitivity | 12.5                  | ± 2.025         | 9.6             | -115              | -118            | -115      |
| 2.4 optimized selectivity | 12.5                  | ± 2.025         | 12.288          | -112              | -114            | -112      |
| 4.8                       | 25                    | ± 2.475         | 19.2            | -112              | -112            | -112      |
| 9.6                       | 50                    | ± 4.95          | 25.6            | -110              | -111            | -110      |
| 19.2                      | 100                   | ± 9.9           | 51.2            | -107              | -108            | -107      |
| 38.4                      | 150                   | ± 19.8          | 102.4           | -104              | -104            | -104      |
| 76.8                      | 200                   | ± 36.0          | 153.6           | -101              | -101            | -101      |
| 153.6                     | 500                   | ± 72.0          | 307.2           | -96               | -97             | -96       |

Table 19. Typical receiver sensitivity as a function of data rate at 433 MHz, FSK modulation, BER =  $10^{-3}$ , pseudo-random data (PN9 sequence)

Note: “Optimized selectivity” in Table 19 is relevant for systems targeting compliance with ARIB STD-T67, 12.5 kHz channel spacing.



| Data rate [kBaud] | Channel spacing [kHz] | Deviation [kHz] | Filter BW [kHz] | Sensitivity [dBm] |                 |           |
|-------------------|-----------------------|-----------------|-----------------|-------------------|-----------------|-----------|
|                   |                       |                 |                 | NRZ mode          | Manchester mode | UART mode |
| 2.4               | 12.5                  | ± 2.025         | 12.288          | -112              | -116            | -112      |
| 4.8               | 25                    | ± 2.475         | 19.2            | -111              | -112            | -111      |
| 9.6               | 50                    | ± 4.95          | 25.6            | -109              | -110            | -109      |
| 19.2              | 100                   | ± 9.9           | 51.2            | -107              | -107            | -107      |
| 38.4              | 150                   | ± 19.8          | 102.4           | -103              | -103            | -103      |
| 76.8              | 200                   | ± 36.0          | 153.6           | -99               | -100            | -99       |
| 153.6             | 500                   | ± 72.0          | 307.2           | -94               | -94             | -94       |

**Table 20. Typical receiver sensitivity as a function of data rate at 868 MHz, FSK modulation, BER = 10<sup>-3</sup>, pseudo-random data (PN9 sequence)**

### 12.5. RSSI

CC1020 has a built-in RSSI (Received Signal Strength Indicator) giving a digital value that can be read from the *RSSI* register. The RSSI reading must be offset and adjusted for VGA gain setting (*VGA\_SETTING[4:0]* in the *VGA3* register).

The digital RSSI value is ranging from 0 to 106 (7 bits).

The RSSI reading is a logarithmic measure of the average voltage amplitude after the digital filter in the digital part of the IF chain:

$$RSSI = 4 \log_2(\text{signal amplitude})$$

The relative power is then given by RSSI x 1.5 dB in a logarithmic scale.

The number of samples used to calculate the average signal amplitude is controlled by *AGC\_AVG[1:0]* in the *VGA2* register. The RSSI update rate is given by:

$$f_{RSSI} = \frac{f_{filter\_clock}}{2^{AGC\_AVG[1:0]+1}}$$

where *AGC\_AVG[1:0]* is set in the *VGA2* register and  $f_{filter\_clock} = 2 \cdot ChBW$ .

Maximum VGA gain is programmed by the *VGA\_SETTING[4:0]* bits. The VGA gain is programmed in approximately 3 dB/LSB. The RSSI measurement can be referred to the power (absolute value) at the *RF\_IN* pin by using the following equation:

$$P = 1.5 \cdot RSSI - 3 \cdot VGA\_SETTING - RSSI\_Offset [dBm]$$

The *RSSI\_Offset* depends on the channel filter bandwidth used due to different VGA settings. Figure 14 and Figure 15 show typical plots of RSSI reading as a function of input power for different channel spacings. See section 12.5 on page 33 for a list of channel filter bandwidths corresponding to the various channel spacings. Refer to Application Note AN030 CC1020/1021 RSSI for further details.

The following method can be used to calculate the power *P* in dBm from the RSSI readout values in Figure 14 and Figure 15:

$$P = 1.5 \cdot [RSSI - RSSI\_ref] + P\_ref$$

where *P* is the output power in dBm for the current RSSI readout value. *RSSI\_ref* is the RSSI readout value taken from Figure 14 or Figure 15 for an input power level of *P\_ref*. Note that the RSSI reading in decimal value changes for different channel filter bandwidths.

The analog filter has a finite dynamic range and is the reason why the RSSI reading is saturated at lower channel spacings. Higher channel spacing is typically used for high frequency deviation and data rates. The analog filter bandwidth is about 160 kHz and is bypassed for high frequency deviation and data rates and is the reason why the RSSI reading is not saturated for 200 kHz and 500 kHz channel spacing in Figure 14 and Figure 15.

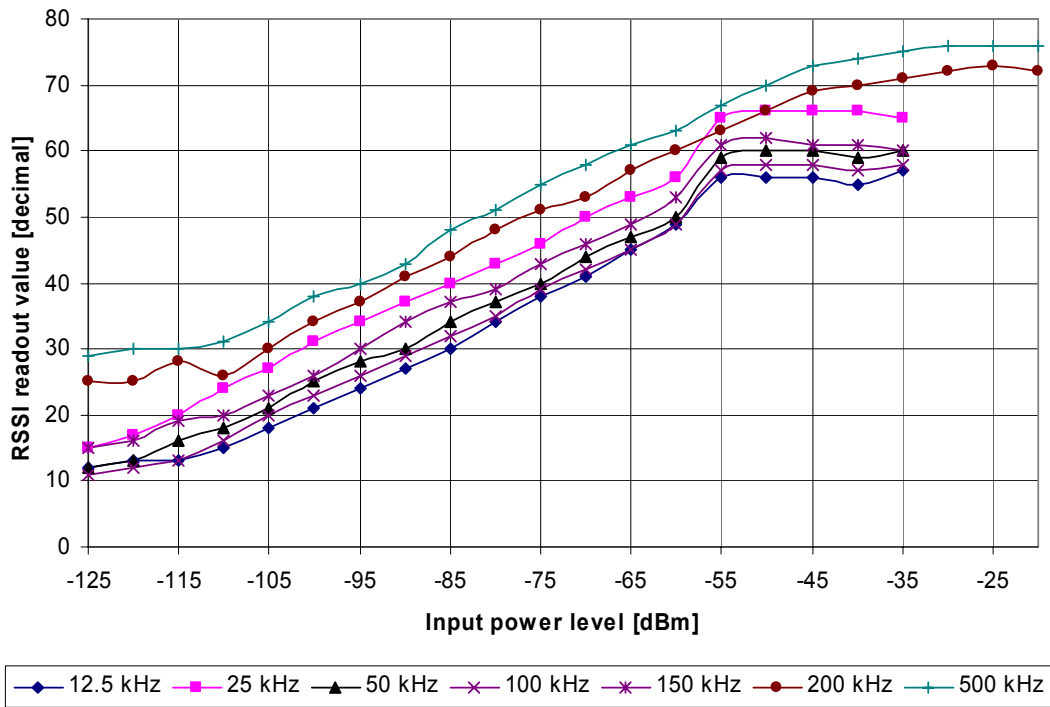


Figure 14. Typical RSSI value vs. input power for some typical channel spacings, 433 MHz

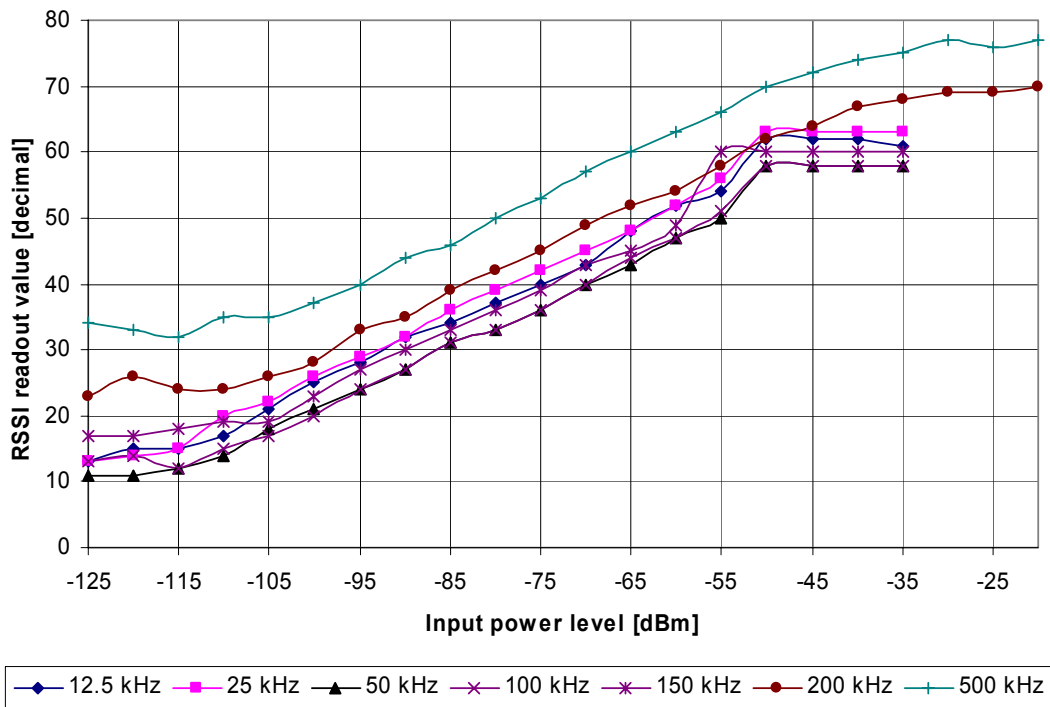


Figure 15. Typical RSSI value vs. input power for some typical channel spacings, 868 MHz

## 12.6. Image Rejection Calibration

For perfect image rejection, the phase and gain of the “I” and “Q” parts of the analog RX chain must be perfectly matched. To improve the image rejection, the “I” and “Q” phase and gain difference can be fine-tuned by adjusting the *PHASE\_COMP* and *GAIN\_COMP* registers. This allows compensation for process variations and other nonidealities. The calibration is done by injecting a signal at the image frequency, and adjusting the phase and gain difference for minimum RSSI value.

During image rejection calibration, an unmodulated carrier should be applied at the image frequency (614.4 kHz below the desired channel). No signal should be present in the desired channel. The signal level should be 50 – 60 dB above the sensitivity in the desired channel, but the optimum level will vary from application to application. Too large input level gives poor results due to limited linearity in the analog IF chain, while too low input level gives poor results due to the receiver noise floor.

For best RSSI accuracy, use *AGC\_AVG[1:0]* = 11 during image rejection calibration (RSSI value is averaged over 16 filter output samples). The *RSSI* register update rate then equals the receiver channel bandwidth (set in *FILTER* register) divided by 8, as the filter output rate is twice the receiver channel bandwidth. This gives the minimum waiting time between *RSSI* register reads (0.5 ms is used below). TI recommends the following image calibration procedure:

1. Define 3 variables:  $XP = 0$ ,  $XG = 0$  and  $DX = 64$ . Go to step 3.
2. Set  $DX = DX/2$ .
3. Write  $XG$  to *GAIN\_COMP* register.
4. If  $XP+2\cdot DX < 127$  then  
     write  $XP+2\cdot DX$  to *PHASE\_COMP* register  
   else  
     write 127 to *PHASE\_COMP* register.
5. Wait at least 3 ms. Measure signal strength  $Y4$  as filtered average of 8 reads from *RSSI* register with 0.5 ms of delay between each *RSSI* read.
6. Write  $XP+DX$  to *PHASE\_COMP* register.
7. Wait at least 3 ms. Measure signal strength  $Y3$  as filtered average of 8 reads from *RSSI* register with 0.5 ms of delay between each *RSSI* read.
8. Write  $XP$  to *PHASE\_COMP* register.
9. Wait at least 3 ms. Measure signal strength  $Y2$  as filtered average of 8 reads from *RSSI* register with 0.5 ms of delay between each *RSSI* read.
10. Write  $XP-DX$  to *PHASE\_COMP* register.

11. Wait at least 3 ms. Measure signal strength  $Y1$  as filtered average of 8 reads from *RSSI* register with 0.5 ms of delay between each *RSSI* read.
12. Write  $XP-2\cdot DX$  to *PHASE\_COMP* register.
13. Wait at least 3 ms. Measure signal strength  $Y0$  as filtered average of 8 reads from *RSSI* register with 0.5 ms of delay between each *RSSI* read.
14. Set  $AP = 2\cdot (Y0-Y2+Y4) - (Y1+Y3)$ .
15. If  $AP > 0$  then  
     set  $DP = \text{ROUND}(7\cdot DX\cdot (2\cdot (Y0-Y4)+Y1-Y3) / (10\cdot AP))$   
   else  
     if  $Y0+Y1 > Y3+Y4$  then  
         set  $DP = DX$   
     else  
         set  $DP = -DX$ .
16. If  $DP > DX$  then  
     set  $DP = DX$   
   else  
     if  $DP < -DX$  then set  $DP = -DX$ .
17. Set  $XP = XP+DP$ .
18. Write  $XP$  to *PHASE\_COMP* register.
19. If  $XG+2\cdot DX < 127$  then  
     write  $XG+2\cdot DX$  to *GAIN\_COMP* register  
   else  
     write 127 to *GAIN\_COMP* register.
20. Wait at least 3 ms. Measure signal strength  $Y4$  as filtered average of 8 reads from *RSSI* register with 0.5 ms of delay between each *RSSI* read.
21. Write  $XG+DX$  to *GAIN\_COMP* register.
22. Wait at least 3 ms. Measure signal strength  $Y3$  as filtered average of 8 reads from *RSSI* register with 0.5 ms of delay between each *RSSI* read.
23. Write  $XG$  to *GAIN\_COMP* register.
24. Wait at least 3 ms. Measure signal strength  $Y2$  as filtered average of 8 reads from *RSSI* register with 0.5 ms of delay between each *RSSI* read.
25. Write  $XG-DX$  to *GAIN\_COMP* register.
26. Wait at least 3 ms. Measure signal strength  $Y1$  as filtered average of 8 reads from *RSSI* register with 0.5 ms of delay between each *RSSI* read.
27. Write  $XG-2\cdot DX$  to *GAIN\_COMP* register.
28. Wait at least 3 ms. Measure signal strength  $Y0$  as filtered average of 8 reads from *RSSI* register with 0.5 ms of delay between each *RSSI* read.
29. Set  $AG = 2\cdot (Y0-Y2+Y4) - (Y1+Y3)$ .
30. If  $AG > 0$  then  
     set  $DG = \text{ROUND}(7\cdot DX\cdot (2\cdot (Y0-Y4)+Y1-Y3) / (10\cdot AG))$   
   else  
     if  $Y0+Y1 > Y3+Y4$  then  
         set  $DG = DX$   
     else  
         set  $DG = -DX$ .
31. If  $DG > DX$  then  
     set  $DG = DX$   
   else  
     if  $DG < -DX$  then set  $DG = -DX$ .
32. Set  $XG = XG+DG$ .
33. If  $DX > 1$  then go to step 2.
34. Write  $XP$  to *PHASE\_COMP* register and  $XG$  to *GAIN\_COMP* register.

If repeated calibration gives varying results, try to change the input level or increase the number of *RSSI* reads  $N$ . A good starting point is  $N=8$ . As accuracy is more important in the last fine-calibration steps, it can be worthwhile to increase  $N$  for each loop iteration.

For high frequency deviation and high data rates (typically  $\geq 76.8$  kBaud) the analog filter succeeding the mixer must be bypassed by setting *FILTER\_BYPASS* = 1 in the *FILTER* register. In this case the image rejection is degraded.

The image rejection is reduced for low supply voltages (typically  $< 2.5$  V) when operating in the 402 – 470 MHz frequency range.

### 12.7. Blocking and Selectivity

Figure 16 shows the blocking/selectivity at 433 MHz, 12.5 kHz channel spacing. Figure 17 shows the blocking/selectivity at 868 MHz, 25 kHz channel spacing. The

blocking rejection is the ratio between a modulated blocker (interferer) and a wanted signal 3 dB above the sensitivity limit.

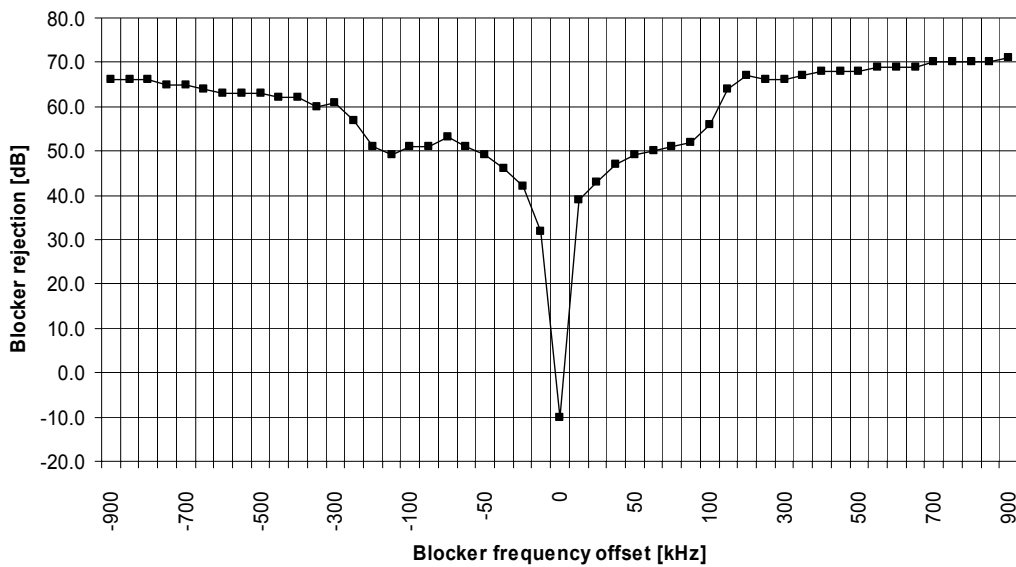


Figure 16. Typical blocker rejection. Carrier frequency set to 434.3072 MHz (12.5 kHz channel spacing, 12.288 kHz receiver channel filter bandwidth)

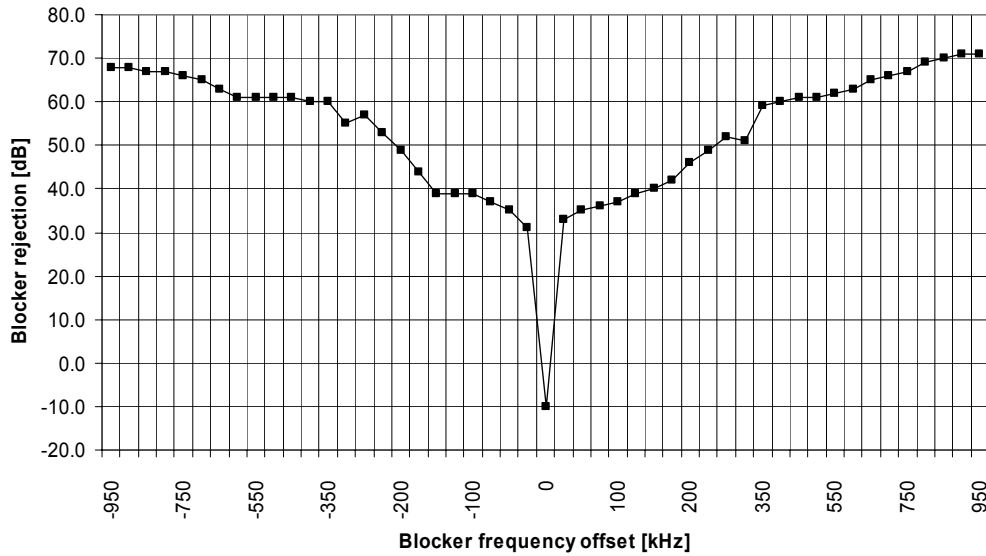


Figure 17. Typical blocker rejection. Carrier frequency set to 868.3072 MHz (25 kHz channel spacing, 19.2 kHz receiver channel filter bandwidth)

## 12.8. Linear IF Chain and AGC Settings

CC1020 is based on a linear IF chain where the signal amplification is done in an analog VGA (Variable Gain Amplifier). The gain is controlled by the digital part of the IF chain after the ADC (Analog to Digital Converter). The AGC (Automatic Gain Control) loop ensures that the ADC operates inside its dynamic range by using an analog/digital feedback loop.

The maximum VGA gain is programmed by the `VGA_SETTING[4:0]` in the `VGA3` register. The VGA gain is programmed in approximately 3 dB/LSB. The VGA gain should be set so that the amplified thermal noise from the front-end balance the quantization noise from the ADC. Therefore the optimum maximum VGA gain setting will depend on the channel filter bandwidth.

A digital RSSI is used to measure the signal strength after the ADC. The `CS_LEVEL[4:0]` in the `VGA4` register is used to set the nominal operating point of the gain control (and also the carrier sense level). Further explanation can be found in Figure 18.

The VGA gain will be changed according to a threshold set by the `VGA_DOWN[2:0]` in the `VGA3` register and the `VGA_UP[2:0]` in the `VGA4` register. Together, these two

values specify the signal strength limits used by the AGC to adjust the VGA gain.

To avoid unnecessary tripping of the VGA, an extra hysteresis and filtering of the RSSI samples can be added. The `AGC_HYSTERESIS` bit in the `VGA2` register enables this.

The time dynamics of the loop can be altered by the `VGA_BLANKING` bit in the `ANALOG` register, and `VGA_FREEZE[1:0]` and `VGA_WAIT[2:0]` bits in the `VGA1` register.

When `VGA_BLANKING` is activated, the VGA recovery time from DC offset spikes after a gain step is reduced.

`VGA_FREEZE` determines the time to hold bit synchronization, VGA and RSSI levels after one of these events occur:

- RX power-up
- The PLL has been out of lock
- Frequency register setting is switched between A and B

This feature is useful to avoid AGC operation during start-up transients and to ensure minimum dwell time using frequency hopping. This means that bit synchronization can be maintained from hop to hop.

VGA\_WAIT determines the time to hold the present bit synchronization and RSSI levels after changing VGA gain. This feature is useful to avoid AGC operation during the settling of transients after a VGA gain change. Some transients are expected due to DC offsets in the VGA.

At the sensitivity limit, the VGA gain is set by VGA\_SETTING. In order to optimize selectivity, this gain should not be set higher than necessary. The SmartRF® Studio software gives the settings for VGA1 – VGA4 registers. For reference, the following method can be used to find the AGC settings:

1. Disable AGC and use maximum LNA2 gain by writing BFh to the VGA2 register. Set minimum VGA gain by writing to the VGA3 register with VGA\_SETTING = 0.
2. Apply no RF input signal, and measure ADC noise floor by reading the RSSI register.
3. Apply no RF input signal, and write VGA3 register with increasing VGA\_SETTING value until the RSSI register value is approximately 4 larger than the value read in step 2. This places the front-end noise floor around 6 dB above the ADC noise floor.
4. Apply an RF signal with strength equal the desired carrier sense threshold. The RF signal should preferably be modulated with correct Baud rate and deviation. Read the RSSI register value, subtract 8, and write to CS\_LEVEL in the VGA4 register. Vary the RF signal level slightly and check that carrier sense indication (bit 3 in STATUS register) switches at the desired input level.
5. If desired, adjust the VGA\_UP and VGA\_DOWN settings according to the explanation in Figure 18.
6. Enable AGC and select LNA2 gain change level. Write 55h to VGA2 register if the resulting VGA\_SETTING > 10. Otherwise, write 45h to VGA2. Modify AGC\_AVG in the above VGA2 value if faster carrier sense and AGC settling is desired.

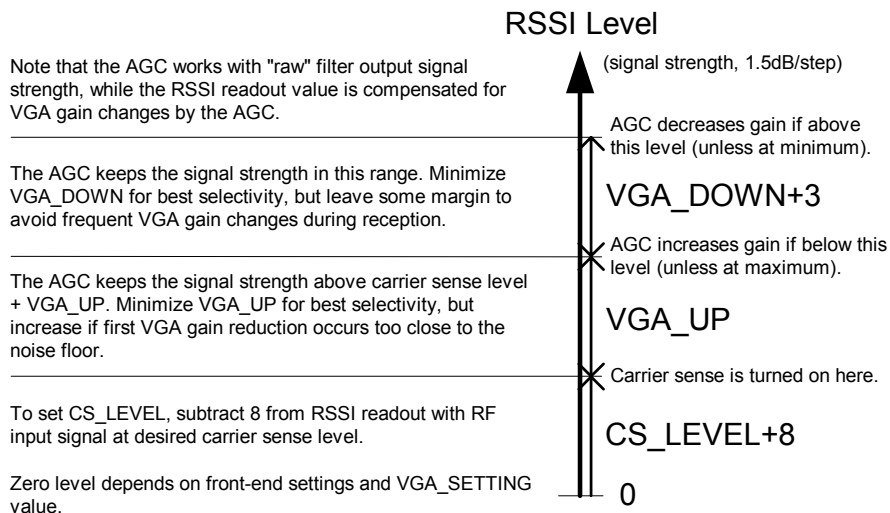


Figure 18. Relationship between RSSI, carrier sense level, and AGC settings CS\_LEVEL, VGA\_UP and VGA\_DOWN

### 12.9. AGC Settling

After turning on the RX chain, the following occurs:

A) The AGC waits 16-128 ADC\_CLK (1.2288 MHz) periods, depending on the VGA\_FREEZE setting in the VGA1 register, for settling in the analog parts.

B) The AGC waits 16-48 FILTER\_CLK periods, depending on the VGA\_WAIT setting in the VGA1 register, for settling in the analog parts and the digital channel filter.

C) The AGC calculates the RSSI value as the average magnitude over the next 2-16

FILTER\_CLK periods, depending on the AGC\_AVG setting in the VGA2 register.

D) If the RSSI value is higher than CS\_LEVEL+8, then the carrier sense indicator is set (if CS\_SET = 0). If the RSSI value is too high according to the CS\_LEVEL, VGA\_UP and VGA\_DOWN settings, and the VGA gain is not already at minimum, then the VGA gain is reduced and the AGC continues from B).

E) If the RSSI value is too low according to the CS\_LEVEL and VGA\_UP settings, and the VGA gain is not already at maximum (given by VGA\_SETTING), then the VGA gain is increased and the AGC continues from B).

2-3 VGA gain changes should be expected before the AGC has settled. Increasing AGC\_AVG increases the settling time, but may be worthwhile if there is the time in the protocol, and for reducing false wake-up events when setting the carrier sense close to the noise floor.

The AGC settling time depends on the FILTER\_CLK (= 2·ChBW). Thus, there is a trade off between AGC settling time and receiver sensitivity because the AGC settling time can be reduced for data rates lower than 76.8 kBaud by using a wider receiver channel filter bandwidth (i.e. larger ChBW).

## 12.10. Preamble Length and Sync Word

The rules for choosing a good sync word are as follows:

1. The sync word should be significantly different from the preamble
2. A large number of transitions is good for the bit synchronization or clock recovery. Equal bits reduce the number of transitions. The recommended sync word has at most 3 equal bits in a row.
3. Autocorrelation. The sync word should not repeat itself, as this will increase the likelihood for errors.
4. In general the first bit of sync should be opposite of last bit in preamble, to achieve one more transition.

The recommended sync words for **CC1020** are 2 bytes (0xD391), 3 bytes (0xD391DA) or 4 bytes (0xD391DA26) and are selected as the best compromise of the above criteria.

Using the register settings provided by the SmartRF® Studio software, packet error rates (PER) less than 0.5% can be achieved when using 24 bits of preamble and a 16 bit sync word (0xD391). Using a preamble longer than 24 bits will improve the PER.

When performing the PER measurements described above the packet format consisted of 10 bytes of random data, 2 bytes CRC and 1 dummy byte in addition to the sync word and preamble at the start of each package.

For the test 1000 packets were sent 10 times. The transmitter was put in power down between each packet. Any bit error in the packet, either in the sync word, in the data or in the CRC caused the packet to be counted as a failed packet.

## 12.11. Carrier Sense

The carrier sense signal is based on the RSSI value and a programmable threshold. The carrier sense function can be used to simplify the implementation of a CSMA (Carrier Sense Multiple Access) medium access protocol.

Carrier sense threshold level is programmed by CS\_LEVEL[4:0] in the VGA4 register and VGA\_SETTING[4:0] in the VGA3 register.

VGA\_SETTING[4:0] sets the maximum gain in the VGA. This value must be set so that the ADC works with optimum dynamic range for a certain channel filter bandwidth. The detected signal strength (after the ADC) will therefore depend on this setting.

CS\_LEVEL[4:0] sets the threshold for this specific VGA\_SETTING[4:0] value. If the VGA\_SETTING[4:0] is changed, the

*CS\_LEVEL[4:0]* must be changed accordingly to maintain the same absolute carrier sense threshold. See Figure 18 for an explanation of the relationship between RSSI, AGC and carrier sense settings.

The carrier sense signal can be read as the *CARRIER\_SENSE* bit in the *STATUS* register.

The carrier sense signal can also be made available at the LOCK pin by setting *LOCK\_SELECT[3:0] = 0100* in the *LOCK* register.

## 12.12. Automatic Power-up Sequencing

*CC1020* has a built-in automatic power-up sequencing state machine. By setting the *CC1020* into this mode, the receiver can be powered-up automatically by a wake-up signal and will then check for a carrier signal (carrier sense). If carrier sense is not detected, it returns to power-down mode. A flow chart for automatic power-up sequencing is shown in Figure 19.

The automatic power-up sequencing mode is selected when *PD\_MODE[1:0] = 11* in the *MAIN* register. When the automatic power-up sequencing mode is selected, the functionality of the *MAIN* register is changed and used to control the sequencing.

By setting *SEQ\_PD = 1* in the *MAIN* register, *CC1020* is set in power down mode. If *SEQ\_PSEL = 1* in the *SEQUENCING* register the automatic power-up sequence is initiated by a negative transition on the PSEL pin.

If *SEQ\_PSEL = 0* in the *SEQUENCING* register, then the automatic power-up sequence is initiated by a negative transition on the DIO pin (as long as *SEP\_DI\_DO = 1* in the *INTERFACE* register).

Sequence timing is controlled through *RX\_WAIT[2:0]* and *CS\_WAIT[3:0]* in the *SEQUENCING* register.

VCO and PLL calibration can also be done automatically as a part of the sequence. This is controlled through *SEQ\_CAL[1:0]* in the *MAIN* register. Calibration can be done every time, every 16<sup>th</sup> sequence, every 256<sup>th</sup> sequence, or never. See the register description for details. A description of when to do, and how the VCO and PLL self-calibration is done, is given in section 15.2 on page 51.

See also Application Note AN070 *CC1020 Automatic Power-Up Sequencing* available from the TI web site.



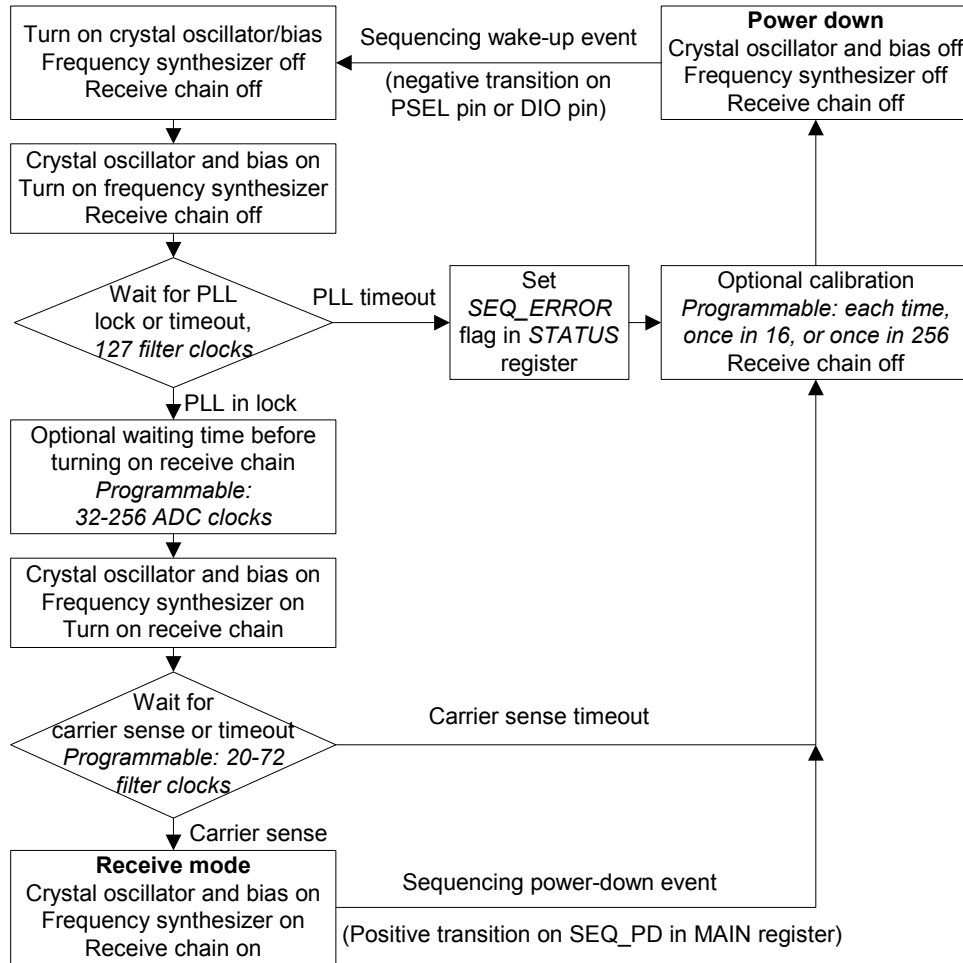


Figure 19. Automatic power-up sequencing flow chart

Notes to Figure 19:

Filter clock (FILTER\_CLK):

$$f_{filter\_clock} = 2 \cdot ChBW$$

where ChBW is defined on page 30.

ADC clock (ADC\_CLK):

$$f_{ADC} = \frac{f_{xoscx}}{2 \cdot (ADC\_DIV[2:0] + 1)}$$

where ADC\_DIV[2:0] is set in the MODEM register.

12.13. Automatic Frequency Control

CC1020 has a built-in feature called AFC (Automatic Frequency Control) that can be used to compensate for frequency drift.

The average frequency offset of the received signal (from the nominal IF frequency) can be read in the AFC register. The signed (2's-complement) 8-bit value AFC[7:0] can be used to compensate for frequency offset between transmitter and receiver.

The frequency offset is given by:

$$\Delta F = AFC \cdot \text{Baud rate} / 16$$

The receiver can be calibrated against the transmitter by changing the operating frequency according to the measured offset. The new frequency must be calculated and written to the FREQ register by the microcontroller. The AFC can be used for an FSK/GFSK signal, but not for OOK. Application Note AN029

CC1020/1021 AFC provides the procedure and equations necessary to implement AFC.

The AFC feature reduces the crystal accuracy requirement.

## 12.14. Digital FM

It is possible to read back the instantaneous IF from the FM demodulator as a frequency offset from the nominal IF frequency. This digital value can be used to perform a pseudo analog FM demodulation.

The frequency offset can be read from the *GAUSS\_FILTER* register and is a signed 8-bit value coded as 2-complement.

The instantaneous deviation is given by:

$$F = \text{GAUSS\_FILTER} \cdot \text{Baud rate} / 8$$

The digital value should be read from the register and sent to a DAC and filtered in order to get an analog audio signal. The internal register value is updated at the *MODEM\_CLK* rate. *MODEM\_CLK* is available at the LOCK pin when *LOCK\_SELECT[3:0]* = 1101 in the *LOCK* register, and can be used to synchronize the reading.

For audio (300 – 4000 Hz) the sampling rate should be higher than or equal to 8

kHz (Nyquist) and is determined by the *MODEM\_CLK*. The *MODEM\_CLK*, which is the sampling rate, equals 8 times the baud rate. That is, the minimum baud rate, which can be programmed, is 1 kBaud. However, the incoming data will be filtered in the digital domain and the 3-dB cut-off frequency is 0.6 times the programmed Baud rate. Thus, for audio the minimum programmed Baud rate should be approximately 7.2 kBaud.

The *GAUSS\_FILTER* resolution decreases with increasing baud rate. An accumulate and dump filter can be implemented in the uC to improve the resolution. Note that each *GAUSS\_FILTER* reading should be synchronized to the *MODEM\_CLK*. As an example, accumulating 4 readings and dividing the total by 4 will improve the resolution by 2 bits.

Furthermore, to fully utilize the *GAUSS\_FILTER* dynamic range the frequency deviation must be 16 times the programmed baud rate.

### 13. Transmitter

#### 13.1. FSK Modulation Formats

The data modulator can modulate FSK, which is a two level FSK (Frequency Shift Keying), or GFSK, which is a Gaussian filtered FSK with BT = 0.5. The purpose of the GFSK is to make a more bandwidth efficient system as shown in Figure 20. The modulation and the Gaussian filtering are done internally in the chip. The

*TX\_SHAPING* bit in the *DEVIATION* register enables the GFSK. GFSK is recommended for narrowband operation.

Figure 21 and Figure 22 show typical eye diagrams for 434 MHz and 868 MHz operation respectively.

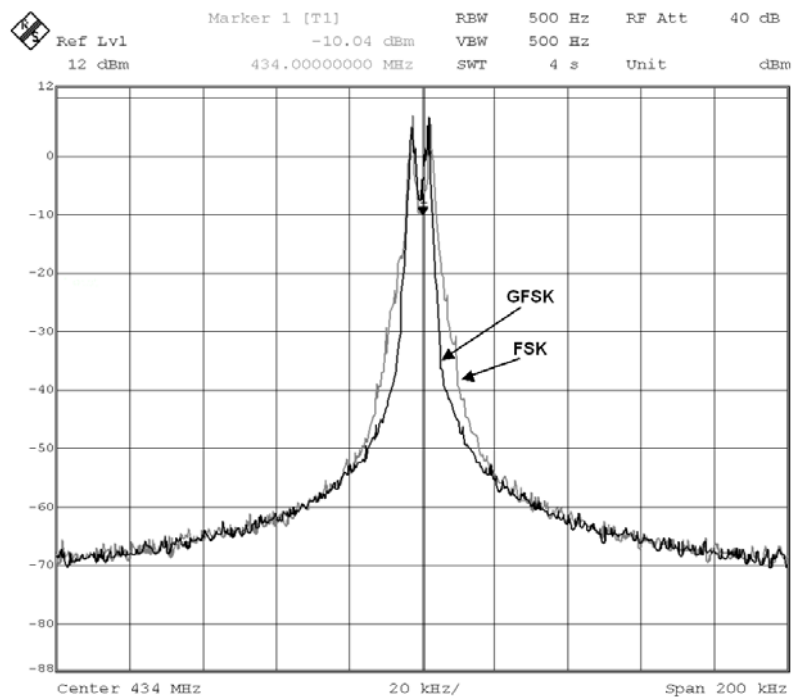


Figure 20. FSK vs. GFSK spectrum plot. 2.4 kBaud, NRZ,  $\pm 2.025$  kHz frequency deviation

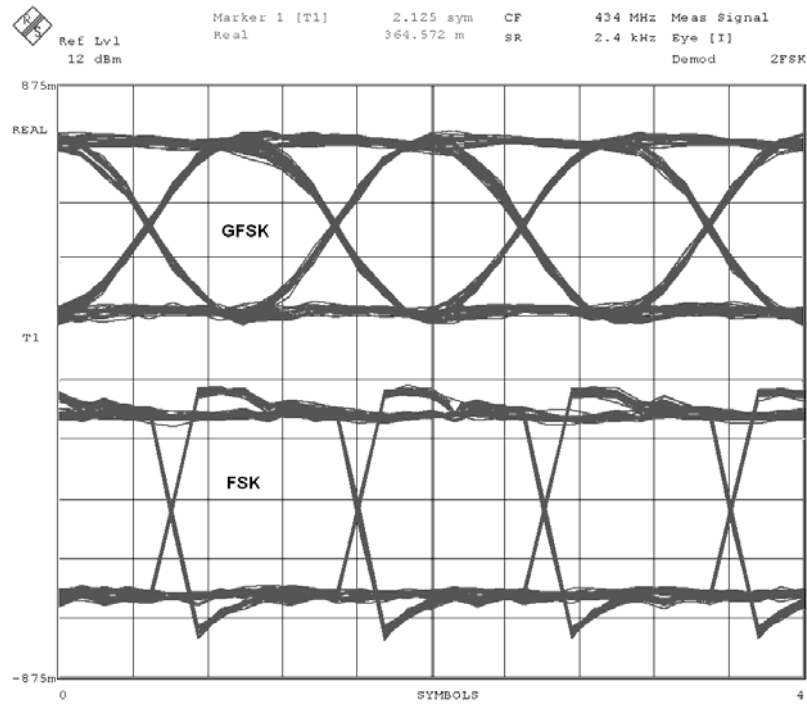


Figure 21. FSK vs. GFSK eye diagram. 2.4 kBaud, NRZ,  $\pm 2.025$  kHz frequency deviation

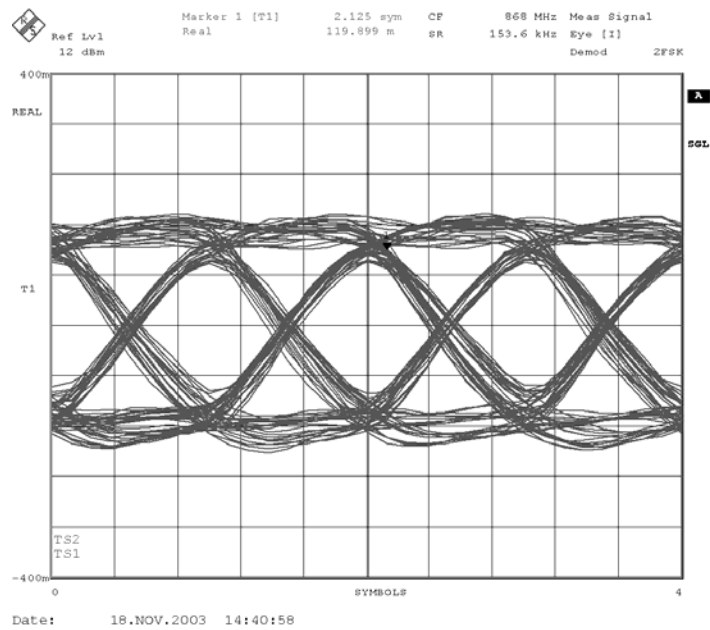


Figure 22. GFSK eye diagram. 153.6 kBaud, NRZ,  $\pm 79.2$  kHz frequency deviation

### 13.2. Output Power Programming

The RF output power from the device is programmable by the 8-bit *PA\_POWER* register. Figure 23 and Figure 24 shows the output power and total current consumption as a function of the *PA\_POWER* register setting. It is more efficient in terms of current consumption to

use either the lower or upper 4-bits in the register to control the power, as shown in the figures. However, the output power can be controlled in finer steps using all the available bits in the *PA\_POWER* register.

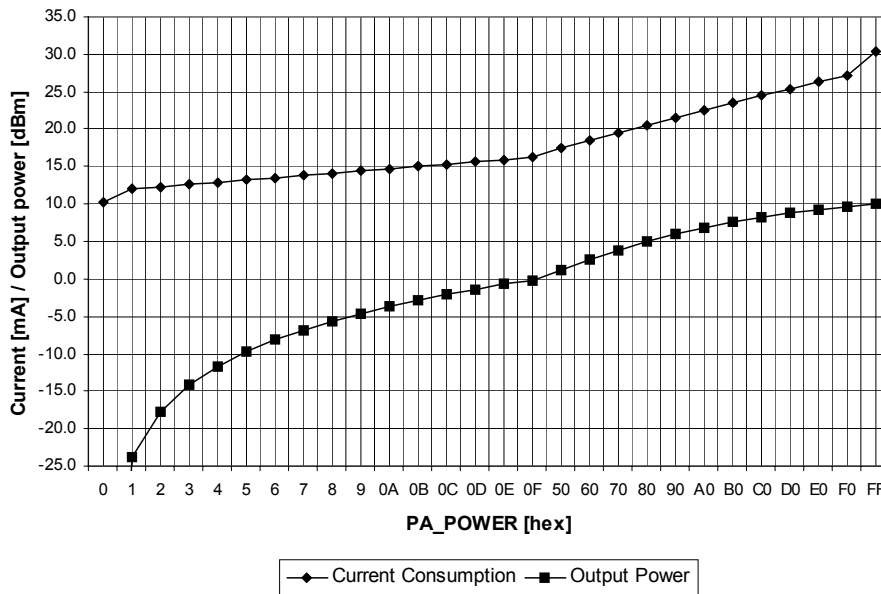


Figure 23. Typical output power and current consumption, 433 MHz

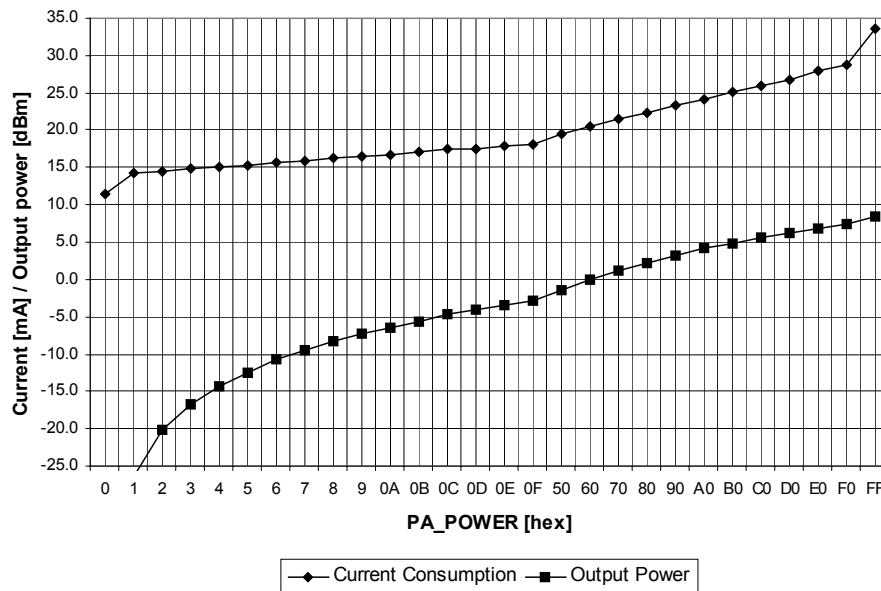


Figure 24. Typical output power and current consumption, 868 MHz

## 13.3. TX Data Latency

The transmitter will add a delay due to the synchronization of the data with DCLK and further clocking into the modulator. The user should therefore add a delay

equivalent to at least 2 bits after the data payload has been transmitted before switching off the PA (i.e. before stopping the transmission).

## 13.4. Reducing Spurious Emission and Modulation Bandwidth

Modulation bandwidth and spurious emission are normally measured with the PA continuously on and a repeated test sequence.

In cases where the modulation bandwidth and spurious emission are measured with the *CC1020* switching from power down mode to TX mode, a **PA ramping** sequence could be used to minimize modulation bandwidth and spurious emission.

PA ramping should then be used both when switching the PA on and off. A linear PA ramping sequence can be used where register PA\_POWER is changed from 00h to 0Fh and then from 50h to the register setting that gives the desired output power (e.g. F0h for +10 dBm output power at 433 MHz operation). The longer the time per PA ramping step the better, but setting the total PA ramping time equal to 2 bit periods is a good compromise between performance and PA ramping time.

## 14. Input / Output Matching and Filtering

When designing the impedance matching network for the *CC1020* the circuit must be matched correctly at the harmonic frequencies as well as at the fundamental tone. A recommended matching network is shown in Figure 25. Component values for various frequencies are given in Table 21. Component values for other frequencies can be found using the SmartRF<sup>®</sup> Studio software.

As can be seen from Figure 25 and Table 21, the 433 MHz network utilizes a T-type filter, while the 868/915 MHz network has a  $\pi$ -type filter topology.

It is important to remember that the physical layout and the components used contribute significantly to the reflection coefficient, especially at the higher harmonics. For this reason, the frequency response of the matching network should

be measured and compared to the response of the TI reference design. Refer to Figure 27 and Table 22 as well as Figure 28 and Table 23.

The use of an external T/R switch reduces current consumption in TX for high output power levels and improves the sensitivity in RX. A recommended application circuit is available from the TI web site (CC1020EMX). The external T/R switch can be omitted in certain applications, but performance will then be degraded.

The match can also be tuned by a shunt capacitor array at the PA output (RF\_OUT). The capacitance can be set in 0.4 pF steps and used either in RX mode or TX mode. The *RX\_MATCH[3:0]* and *TX\_MATCH[3:0]* bits in the *MATCH* register control the capacitor array.

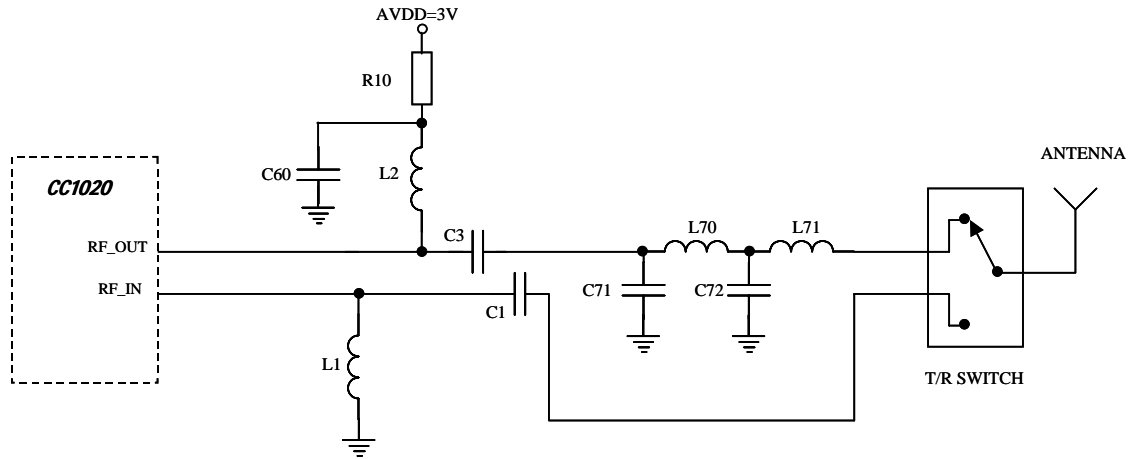


Figure 25. Input/output matching network

| Item | 433 MHz                | 868 MHz                   | 915 MHz                   |
|------|------------------------|---------------------------|---------------------------|
| C1   | 10 pF, 5%, NP0, 0402   | 47 pF, 5%, NP0, 0402      | 47 pF, 5%, NP0, 0402      |
| C3   | 5.6 pF, 5%, NP0, 0402  | 10 pF, 5%, NP0, 0402      | 10 pF, 5%, NP0, 0402      |
| C60  | 220 pF, 5%, NP0, 0402  | 220 pF, 5%, NP0, 0402     | 220 pF, 5%, NP0, 0402     |
| C71  | DNM                    | 8.2 pF 5%, NP0, 0402      | 8.2 pF 5%, NP0, 0402      |
| C72  | 4.7 pF, 5%, NP0, 0402  | 8.2 pF 5%, NP0, 0402      | 8.2 pF 5%, NP0, 0402      |
| L1   | 33 nH, 5%, 0402        | 82 nH, 5%, 0402           | 82 nH, 5%, 0402           |
| L2   | 22 nH, 5%, 0402        | 3.6 nH, 5%, 0402          | 3.6 nH, 5%, 0402          |
| L70  | 47 nH, 5%, 0402        | 5.1 nH, 5%, 0402          | 5.1 nH, 5%, 0402          |
| L71  | 39 nH, 5%, 0402        | 0 $\Omega$ resistor, 0402 | 0 $\Omega$ resistor, 0402 |
| R10  | 82 $\Omega$ , 5%, 0402 | 82 $\Omega$ , 5%, 0402    | 82 $\Omega$ , 5%, 0402    |

Table 21. Component values for the matching network described in Figure 25 (DNM = Do Not Mount).

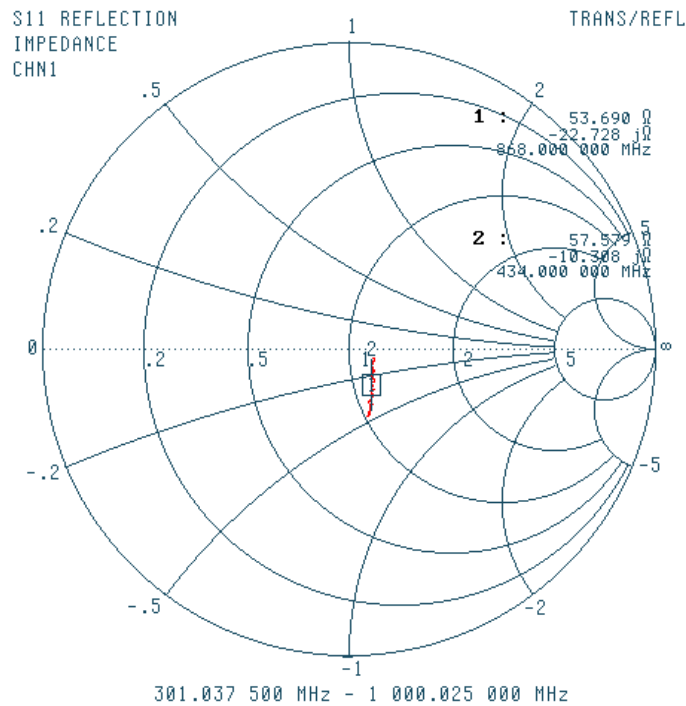


Figure 26. Typical LNA input impedance, 200 – 1000 MHz

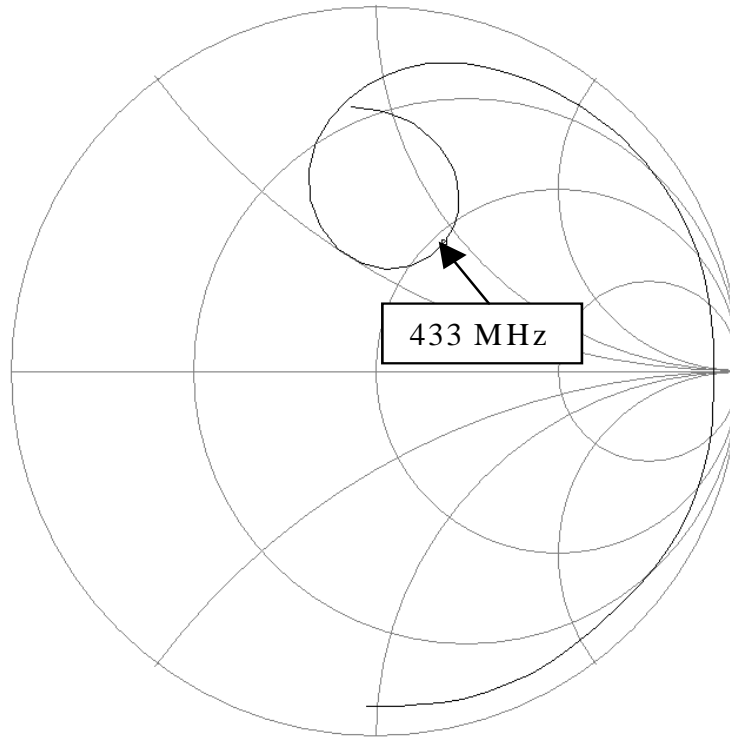
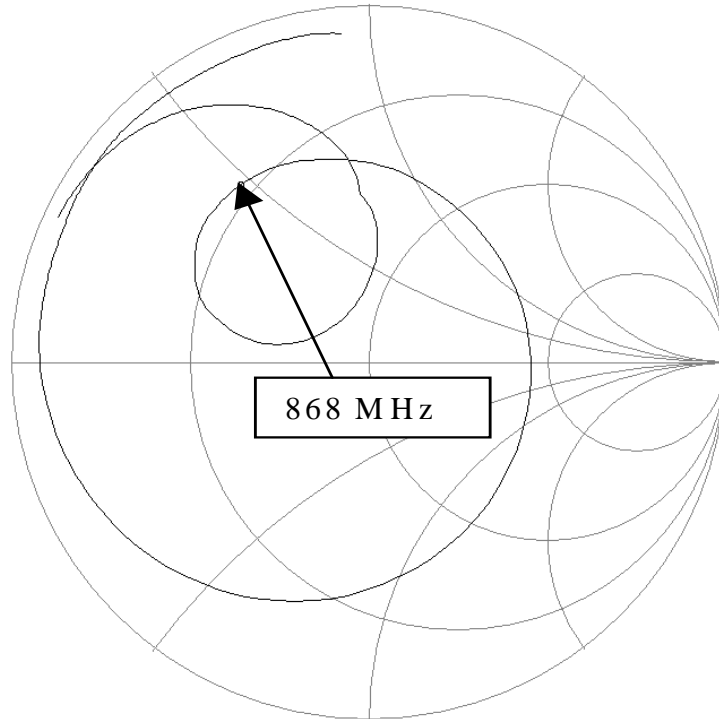


Figure 27. Typical optimum PA load impedance, 433 MHz. The frequency is swept from 300 MHz to 2500 MHz. Values are listed in Table 22

| Frequency (MHz) | Real (Ohms) | Imaginary (Ohms) |
|-----------------|-------------|------------------|
| 433             | 54          | 44               |
| 866             | 20          | 173              |
| 1299            | 288         | -563             |
| 1732            | 14          | -123             |
| 2165            | 5           | -66              |

Table 22. Impedances at the first 5 harmonics (433 MHz matching network)





**Figure 28: Typical optimum PA load impedance, 868/915 MHz. The frequency is swept from 300 MHz to 2800 MHz. Values are listed in Table 23**

| Frequency (MHz) | Real (Ohms) | Imaginary (Ohms) |
|-----------------|-------------|------------------|
| 868             | 15          | 24               |
| 915             | 20          | 35               |
| 1736            | 1.5         | 18               |
| 1830            | 1.7         | 22               |
| 2604            | 3.2         | 44               |
| 2745            | 3.6         | 45               |

**Table 23. Impedances at the first 3 harmonics (868/915 MHz matching network)**

## 15. Frequency Synthesizer

### 15.1. VCO, Charge Pump and PLL Loop Filter

The VCO is completely integrated and operates in the 1608 – 1920 MHz range. A frequency divider is used to get a frequency in the UHF range (402 – 470 and 804 – 960 MHz). The *BANDSELECT* bit in the *ANALOG* register selects the frequency band.

The VCO frequency is given by:

$$f_{VCO} = f_{ref} \cdot \left( 3 + \frac{FREQ + 0.5 \cdot DITHER}{8192} \right)$$

The VCO frequency is divided by 2 and by 4 to generate frequencies in the two bands, respectively.

The VCO sensitivity (sometimes referred to as VCO gain) varies over frequency and operating conditions. Typically the VCO sensitivity varies between 12 and 36 MHz/V. For calculations the geometrical mean at 21 MHz/V can be used. The PLL calibration (explained below) measures the actual VCO sensitivity and adjusts the charge pump current accordingly to achieve correct PLL loop gain and bandwidth (higher charge pump current when VCO sensitivity is lower).

The following equations can be used for calculating PLL loop filter component values, see Figure 3, for a desired PLL loop bandwidth, BW:

$$\begin{aligned} C7 &= 3037 (f_{ref} / BW^2) - 7 && \text{[pF]} \\ R2 &= 7126 (BW / f_{ref}) && \text{[k}\Omega\text{]} \\ C6 &= 80.75 (f_{ref} / BW^2) && \text{[nF]} \\ R3 &= 21823 (BW / f_{ref}) && \text{[k}\Omega\text{]} \\ C8 &= 839 (f_{ref} / BW^2) - 6 && \text{[pF]} \end{aligned}$$

Define a minimum PLL loop bandwidth as  $BW_{min} = \sqrt{80.75 \cdot f_{ref} / 220}$ . If  $BW_{min} >$  Baud rate/3 then set  $BW = BW_{min}$  and if  $BW_{min} <$  Baud rate/3 then set  $BW =$  Baud rate/3 in the above equations.

There are two special cases when using the recommended 14.7456 MHz crystal:

- 1) If the data rate is 4.8 kBaud or below and the channel spacing is 12.5 kHz the following loop filter components are recommended:

$$\begin{aligned} C6 &= 220 \text{ nF} \\ C7 &= 8200 \text{ pF} \\ C8 &= 2200 \text{ pF} \\ R2 &= 1.5 \text{ k}\Omega \\ R3 &= 4.7 \text{ k}\Omega \end{aligned}$$

- 2) If the data rate is 4.8 kBaud or below and the channel spacing is different from 12.5 kHz the following loop filter components are recommended:

$$\begin{aligned} C6 &= 100 \text{ nF} \\ C7 &= 3900 \text{ pF} \\ C8 &= 1000 \text{ pF} \\ R2 &= 2.2 \text{ k}\Omega \\ R3 &= 6.8 \text{ k}\Omega \end{aligned}$$

After calibration the PLL bandwidth is set by the *PLL\_BW* register in combination with the external loop filter components calculated above. The *PLL\_BW* can be found from

$$PLL\_BW = 174 + 16 \log_2(f_{ref} / 7.126)$$

where  $f_{ref}$  is the reference frequency (in MHz). The PLL loop filter bandwidth increases with increasing *PLL\_BW* setting. Note that in SmartRF® Studio *PLL\_BW* is fixed to 9E hex when the channel spacing is set up for 12.5 kHz, optimized selectivity.

After calibration the applied charge pump current (*CHP\_CURRENT[3:0]*) can be read in the *STATUS1* register. The charge pump current is approximately given by:

$$I_{CHP} = 16 \cdot 2^{CHP\_CURRENT / 4} [\mu A]$$

The combined charge pump and phase detector gain (in A/rad) is given by the charge pump current divided by  $2\pi$ .

The PLL bandwidth will limit the maximum modulation frequency and hence data rate.

## 15.2. VCO and PLL Self-Calibration

To compensate for supply voltage, temperature and process variations, the VCO and PLL must be calibrated. The calibration is performed automatically and sets the maximum VCO tuning range and optimum charge pump current for PLL stability. After setting up the device at the operating frequency, the self-calibration can be initiated by setting the *CAL\_START* bit in the *CALIBRATE* register. The calibration result is stored internally in the chip, and is valid as long as power is not turned off. If large supply voltage drops (typically more than 0.25 V) or temperature variations (typically more than 40°C) occur after calibration, a new calibration should be performed.

The nominal VCO control voltage is set by the *CAL\_ITERATE[2:0]* bits in the *CALIBRATE* register.

The *CAL\_COMPLETE* bit in the *STATUS* register indicates that calibration has finished. The calibration wait time (*CAL\_WAIT*) is programmable and is inverse proportional to the internal PLL reference frequency. The highest possible reference frequency should be used to get the minimum calibration time. It is recommended to use *CAL\_WAIT[1:0] = 11* in order to get the most accurate loop bandwidth.

| Calibration time [ms] | Reference frequency [MHz] |        |        |
|-----------------------|---------------------------|--------|--------|
|                       | 1.8432                    | 7.3728 | 9.8304 |
| CAL_WAIT              |                           |        |        |
| 00                    | 49 ms                     | 12 ms  | 10 ms  |
| 01                    | 60 ms                     | 15 ms  | 11 ms  |
| 10                    | 71 ms                     | 18 ms  | 13 ms  |
| 11                    | 109 ms                    | 27 ms  | 20 ms  |

**Table 24. Typical calibration times**

The *CAL\_COMPLETE* bit can also be monitored at the LOCK pin, configured by *LOCK\_SELECT[3:0] = 0101*, and used as an interrupt input to the microcontroller.

To check that the PLL is in lock the user should monitor the *LOCK\_CONTINUOUS* bit in the *STATUS* register. The *LOCK\_CONTINUOUS* bit can also be monitored at the LOCK pin, configured by *LOCK\_SELECT[3:0] = 0010*.

There are separate calibration values for the two frequency registers. However, dual calibration is possible if all of the below conditions apply:

- The two frequencies A and B differ by less than 1 MHz
- Reference frequencies are equal (*REF\_DIV\_A[2:0] = REF\_DIV\_B[2:0]* in the *CLOCK\_A/CLOCK\_B* registers)
- VCO currents are equal (*VCO\_CURRENT\_A[3:0] = VCO\_CURRENT\_B[3:0]* in the *VCO* register).

The *CAL\_DUAL* bit in the *CALIBRATE* register controls dual or separate calibration.

The single calibration algorithm (*CAL\_DUAL=0*) using separate calibration for RX and TX frequency is illustrated in Figure 29. The same algorithm is applicable for dual calibration if *CAL\_DUAL=1*. Application Note AN023 *CC1020 MCU Interfacing*, available from the TI web site, includes example source code for single calibration.

TI recommends that single calibration be used for more robust operation.

There is a small, but finite, possibility that the PLL self-calibration will fail. The calibration routine in the source code should include a loop so that the PLL is re-calibrated until PLL lock is achieved if the PLL does not lock the first time. Refer to **CC1020** Errata Note 004.

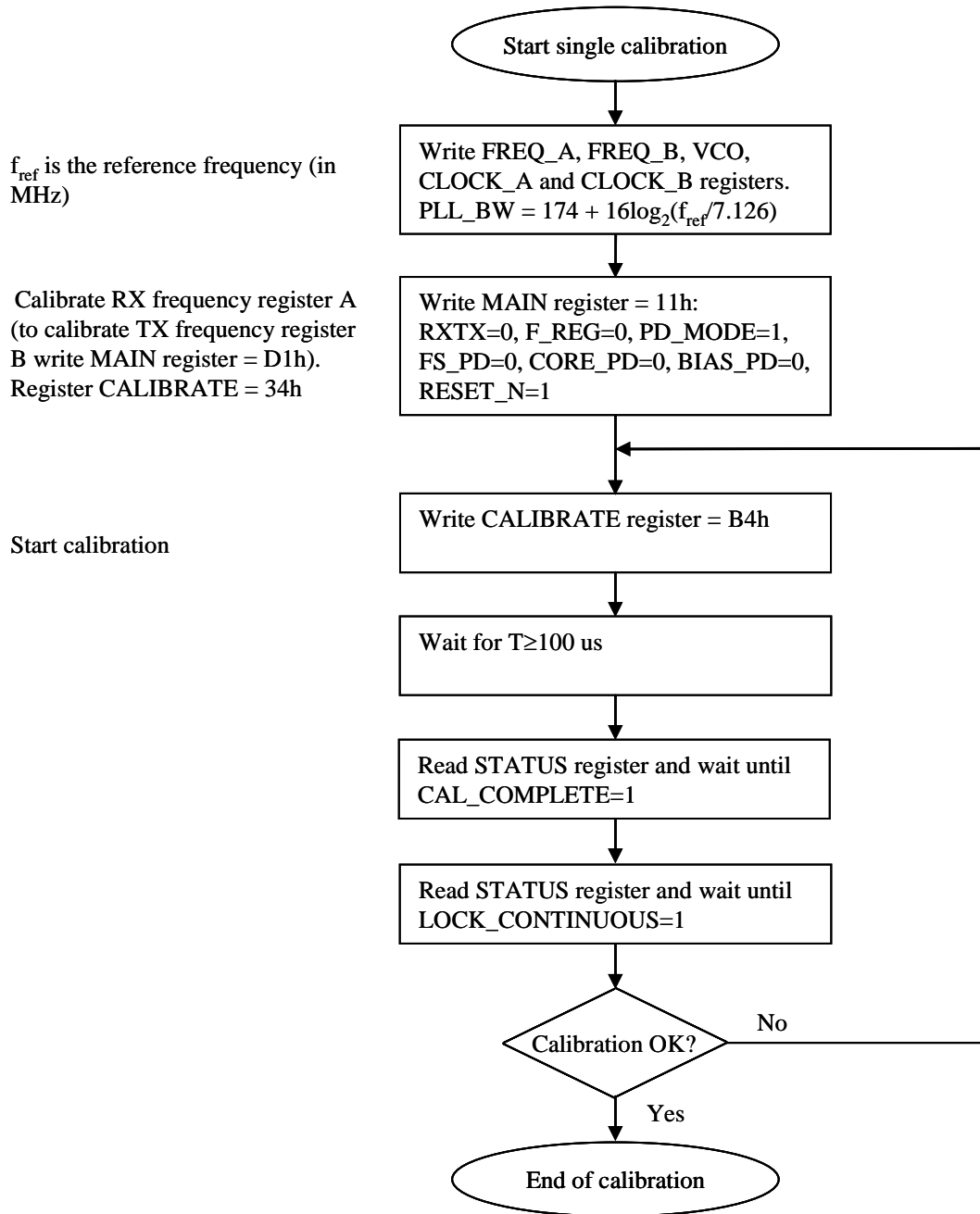


Figure 29. Single calibration algorithm for RX and TX

### 15.3. PLL Turn-on Time versus Loop Filter Bandwidth

If calibration has been performed the PLL turn-on time is the time needed for the PLL to lock to the desired frequency when going from power down mode (with the crystal oscillator running) to TX or RX

mode. The PLL turn-on time depends on the PLL loop filter bandwidth. Table 25 gives the PLL turn-on time for different PLL loop filter bandwidths.

| C6 [nF] | C7 [pF] | C8 [pF] | R2 [kΩ] | R3 [kΩ] | PLL turn-on time [us] | Comment  |
|---------|---------|---------|---------|---------|-----------------------|--|
| 220     | 8200    | 2200    | 1.5     | 4.7     | 3200                  | Up to 4.8 kBaud data rate, 12.5 kHz channel spacing  |
| 100     | 3900    | 1000    | 2.2     | 6.8     | 2500                  | Up to 4.8 kBaud data rate, 25 kHz channel spacing    |
| 56      | 2200    | 560     | 3.3     | 10      | 1400                  | Up to 9.6 kBaud data rate, 50 kHz channel spacing    |
| 15      | 560     | 150     | 5.6     | 18      | 1300                  | Up to 19.2 kBaud data rate, 100 kHz channel spacing  |
| 3.9     | 120     | 33      | 12      | 39      | 1080                  | Up to 38.4 kBaud data rate, 150 kHz channel spacing  |
| 1.0     | 27      | 3.3     | 27      | 82      | 950                   | Up to 76.8 kBaud data rate, 200 kHz channel spacing  |
| 0.2     | 1.5     | -       | 47      | 150     | 700                   | Up to 153.6 kBaud data rate, 500 kHz channel spacing |

**Table 25. Typical PLL turn-on time to within ±10% of channel spacing for different loop filter bandwidths**

### 15.4. PLL Lock Time versus Loop Filter Bandwidth

If calibration has been performed the PLL lock time is the time needed for the PLL to lock to the desired frequency when going from RX to TX mode or vice versa. The

PLL lock time depends on the PLL loop filter bandwidth. Table 26 gives the PLL lock time for different PLL loop filter bandwidths.

| C6 [nF] | C7 [pF] | C8 [pF] | R2 [kΩ] | R3 [kΩ] | PLL lock time [us] |     |      | Comment  |
|---------|---------|---------|---------|---------|--------------------|-----|------|--|
|         |         |         |         |         | 1                  | 2   | 3    |  |
| 220     | 8200    | 2200    | 1.5     | 4.7     | 900                | 180 | 1300 | Up to 4.8 kBaud data rate, 12.5 kHz channel spacing  |
| 100     | 3900    | 1000    | 2.2     | 6.8     | 640                | 270 | 830  | Up to 4.8 kBaud data rate, 25 kHz channel spacing    |
| 56      | 2200    | 560     | 3.3     | 10      | 400                | 140 | 490  | Up to 9.6 kBaud data rate, 50 kHz channel spacing    |
| 15      | 560     | 150     | 5.6     | 18      | 140                | 70  | 230  | Up to 19.2 kBaud data rate, 100 kHz channel spacing  |
| 3.9     | 120     | 33      | 12      | 39      | 75                 | 50  | 180  | Up to 38.4 kBaud data rate, 150 kHz channel spacing  |
| 1.0     | 27      | 3.3     | 27      | 82      | 30                 | 15  | 55   | Up to 76.8 kBaud data rate, 200 kHz channel spacing  |
| 0.2     | 1.5     | -       | 47      | 150     | 14                 | 14  | 28   | Up to 153.6 kBaud data rate, 500 kHz channel spacing |

**Table 26. Typical PLL lock time to within ±10% of channel spacing for different loop filter bandwidths. 1) 307.2 kHz step, 2) 1 channel step, 3) 1 MHz step**

### 16. VCO and LNA Current Control

The VCO current is programmable and should be set according to operating frequency, RX/TX mode and output power. Recommended settings for the *VCO\_CURRENT* bits in the *VCO* register are shown in the register overview and also given by SmartRF® Studio. The VCO current for frequency *FREQ\_A* and

*FREQ\_B* can be programmed independently.

The bias currents for the LNA, mixer and the LO and PA buffers are also programmable. The *FRONTEND* and the *BUFF\_CURRENT* registers control these currents.

## 17. Power Management

**CC1020** offers great flexibility for power management in order to meet strict power consumption requirements in battery-operated applications. Power down mode is controlled through the *MAIN* register. There are separate bits to control the RX part, the TX part, the frequency synthesizer and the crystal oscillator in the *MAIN* register. This individual control can be used to optimize for lowest possible current consumption in each application. Figure 30 shows a typical power-on and initializing sequence for minimum power consumption.

Figure 31 shows a typical sequence for activating RX and TX mode from power down mode for minimum power consumption.

Note that PSEL should be tri-stated or set to a high level during power down mode in order to prevent a trickle current from flowing in the internal pull-up resistor.

Application Note *AN023 CC1020 MCU Interfacing* includes example source code and is available from the TI web site.

TI recommends resetting the **CC1020** (by clearing the *RESET\_N* bit in the *MAIN* register) when the chip is powered up initially. All registers that need to be configured should then be programmed (those which differ from their default values). Registers can be programmed freely in any order. The **CC1020** should

then be calibrated in both RX and TX mode. After this is completed, the **CC1020** is ready for use. See the detailed procedure flowcharts in Figure 29 – Figure 31.

With reference to Application Note *AN023 CC1020 MCU Interfacing* TI recommends the following sequence:

After power up:

- 1) ResetCC1020
- 2) Initialize
- 3) WakeUpCC1020ToRX
- 4) Calibrate
- 5) WakeUpCC1020ToTX
- 6) Calibrate

After calibration is completed, enter TX mode (SetupCC1020TX), RX mode (SetupCC1020RX) or power down mode (SetupCC1020PD)

From power-down mode to RX:

- 1) WakeUpCC1020ToRX
- 2) SetupCC1020RX

From power-down mode to TX:

- 1) WakeUpCC1020ToTX
- 2) SetupCC1020TX

Switching from RX to TX mode:

- 1) SetupCC1020TX

Switching from TX to RX mode:

- 1 SetupCC1020RX

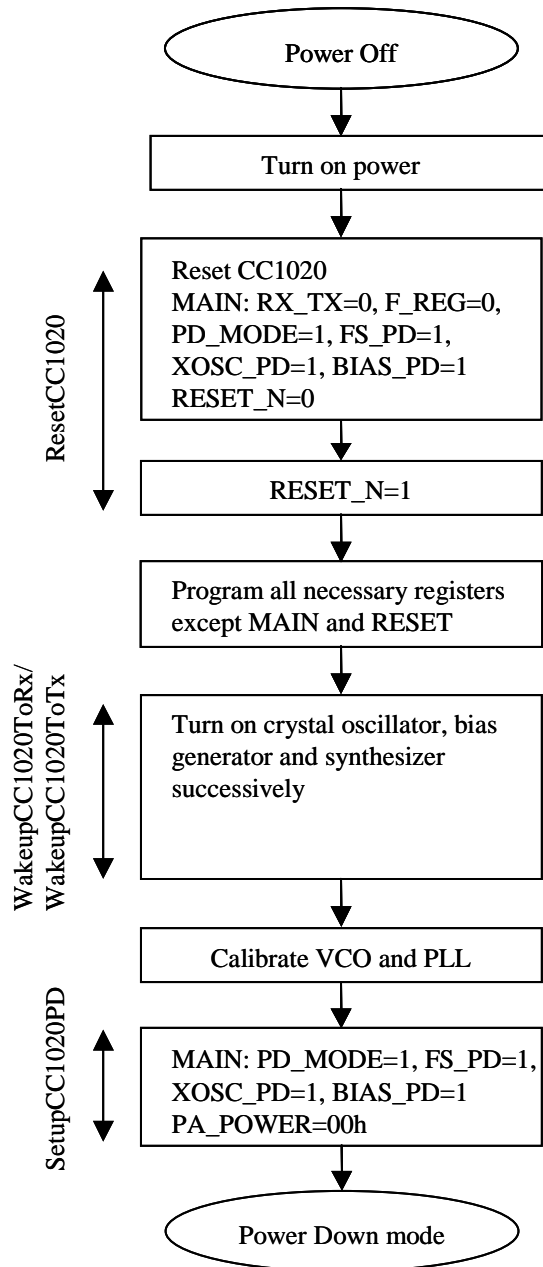


Figure 30. Initialising sequence

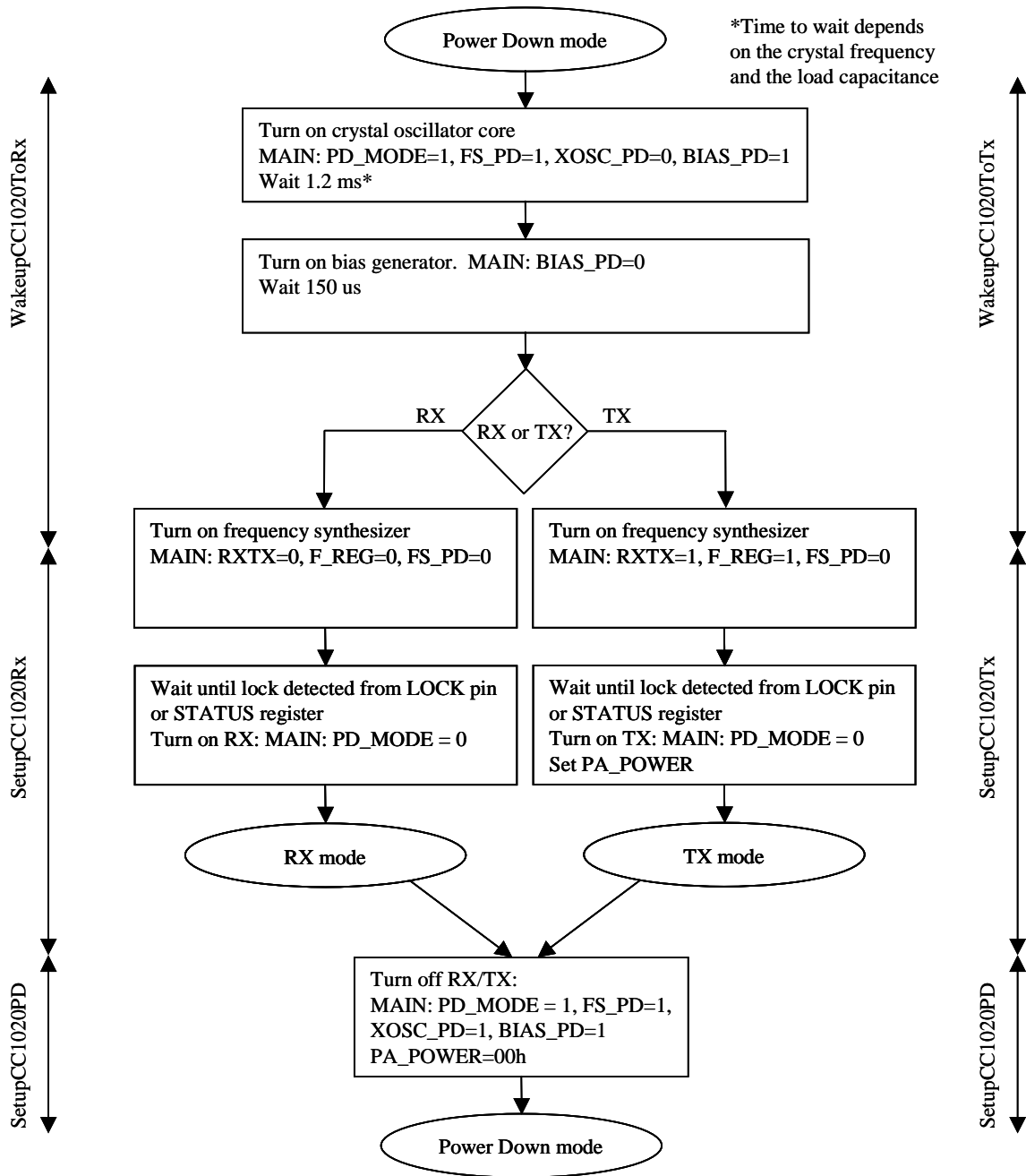


Figure 31. Sequence for activating RX or TX mode



### 18. On-Off Keying (OOK)

The data modulator can also provide OOK (On-Off Keying) modulation. OOK is an ASK (Amplitude Shift Keying) modulation using 100% modulation depth. OOK modulation is enabled in RX and in TX by setting  $TXDEV\_M[3:0] = 0000$  in the *DEVIATION* register. An OOK eye diagram is shown in Figure 32.

The data demodulator can also perform OOK demodulation. The demodulation is done by comparing the signal level with the “carrier sense” level (programmed as *CS\_LEVEL* in the *VGA4* register). The signal is then decimated and filtered in the data filter. Data decision and bit synchronization are as for FSK reception.

In this mode *AGC\_AVG* in the *VGA2* register must be set to 3. The channel bandwidth must be 4 times the Baud rate for data rates up to 9.6 kBaud. For the highest data rates the channel bandwidth

must be 2 times the Baud rate (see Table 27). Manchester coding must always be used for OOK.

Note that the automatic frequency control (AFC) cannot be used when receiving OOK, as it requires a frequency shift.

The AGC has a certain time-constant determined by *FILTER\_CLK*, which depends on the IF filter bandwidth. There is a lower limit on *FILTER\_CLK* and hence the AGC time constant. For very low data rates the minimum time constant is too fast and the AGC will increase the gain when a “0” is received and decrease the gain when a “1” is received. For this reason the minimum data rate in OOK is 2.4 kBaud.

Typical figures for the receiver sensitivity ( $BER = 10^{-3}$ ) are shown in Table 27 for OOK.

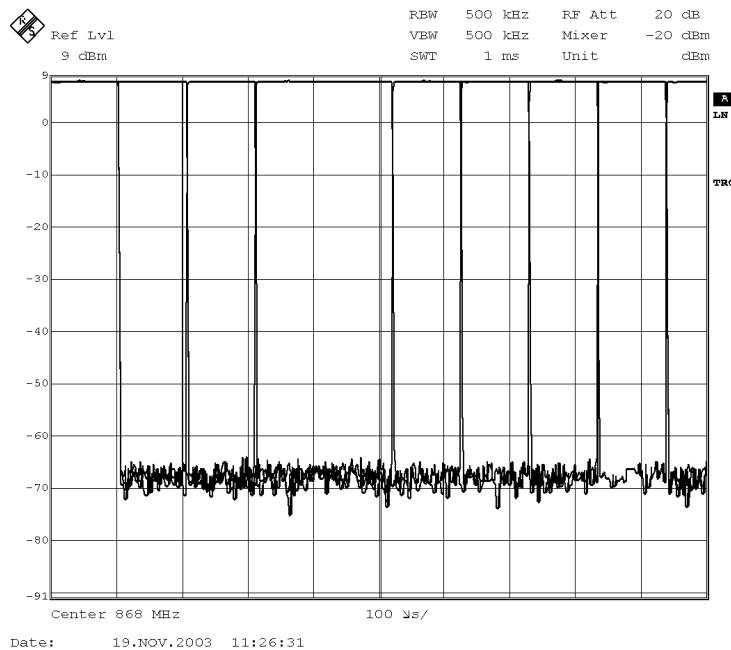


Figure 32. OOK eye diagram. 9.6 kBaud

| Data rate [kBaud] | Filter BW [kHz] | Sensitivity [dBm]       |                         |
|-------------------|-----------------|-------------------------|-------------------------|
|                   |                 | 433 MHz Manchester mode | 868 MHz Manchester mode |
| 2.4               | 9.6             | -116                    |                         |
| 4.8               | 19.2            | -113                    | -107                    |
| 9.6               | 38.4            | -103                    | -104                    |
| 19.2              | 51.2            | -102                    | -101                    |
| 38.4              | 102.4           | -95                     | -97                     |
| 76.8              | 153.6           | -92                     | -94                     |
| 153.6             | 307.2           | -81                     | -87                     |

Table 27. Typical receiver sensitivity as a function of data rate at 433 and 868 MHz, OOK modulation, BER = 10<sup>-3</sup>, pseudo-random data (PN9 sequence)

### 19. Crystal Oscillator

The recommended crystal frequency is 14.7456 MHz, but any crystal frequency in the range 4 – 20 MHz can be used. Using a crystal frequency different from 14.7456 MHz might in some applications give degraded performance. Refer to Application Note AN022 *Crystal Frequency Selection* for more details on the use of other crystal frequencies than 14.7456 MHz. The crystal frequency is used as reference for the data rate (as well as other internal functions) and in the 4 – 20 MHz range the frequencies 4.9152, 7.3728, 9.8304, 12.2880, 14.7456, 17.2032, 19.6608 MHz will give accurate data rates as shown in Table 17 and an IF frequency of 307.2 kHz. The crystal frequency will influence the programming of the *CLOCK\_A*, *CLOCK\_B* and *MODEM* registers.

An external clock signal or the internal crystal oscillator can be used as main frequency reference. An external clock signal should be connected to XOSC\_Q1, while XOSC\_Q2 should be left open. The XOSC\_BYPASS bit in the *INTERFACE* register should be set to '1' when an external digital rail-to-rail clock signal is used. No DC block should be used then. A sine with smaller amplitude can also be used. A DC blocking capacitor must then be used (10 nF) and the XOSC\_BYPASS bit in the *INTERFACE* register should be set to '0'. For input signal amplitude, see section 4.5 on page 12.

Using the internal crystal oscillator, the crystal must be connected between the XOSC\_Q1 and XOSC\_Q2 pins. The oscillator is designed for parallel mode operation of the crystal. In addition, loading capacitors (C4 and C5) for the

crystal are required. The loading capacitor values depend on the total load capacitance, C<sub>L</sub>, specified for the crystal. The total load capacitance seen between the crystal terminals should equal C<sub>L</sub> for the crystal to oscillate at the specified frequency.

$$C_L = \frac{1}{\frac{1}{C_4} + \frac{1}{C_5}} + C_{parasitic}$$

The parasitic capacitance is constituted by pin input capacitance and PCB stray capacitance. Total parasitic capacitance is typically 8 pF. A trimming capacitor may be placed across C5 for initial tuning if necessary.

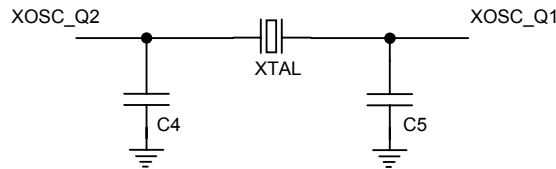
The crystal oscillator circuit is shown in Figure 33. Typical component values for different values of C<sub>L</sub> are given in Table 28.

The crystal oscillator is amplitude regulated. This means that a high current is required to initiate the oscillations. When the amplitude builds up, the current is reduced to what is necessary to maintain approximately 600 mVpp amplitude. This ensures a fast start-up, keeps the drive level to a minimum and makes the oscillator insensitive to ESR variations. As long as the recommended load capacitance values are used, the ESR is not critical.

The initial tolerance, temperature drift, aging and load pulling should be carefully specified in order to meet the required frequency accuracy in a certain

application. By specifying the *total* expected frequency accuracy in SmartRF® Studio together with data rate and frequency separation, the software will estimate the total bandwidth and compare

to the available receiver channel filter bandwidth. The software will report any contradictions and a more accurate crystal will be recommended if required.



**Figure 33. Crystal oscillator circuit**

| Item | C <sub>L</sub> = 12 pF | C <sub>L</sub> = 16 pF | C <sub>L</sub> = 22 pF |
|------|------------------------|------------------------|------------------------|
| C4   | 6.8 pF                 | 15 pF                  | 27 pF                  |
| C5   | 6.8 pF                 | 15 pF                  | 27 pF                  |

**Table 28. Crystal oscillator component values**

## 20. Built-in Test Pattern Generator

The *CC1020* has a built-in test pattern generator that generates a PN9 pseudo random sequence. The *PN9\_ENABLE* bit in the *MODEM* register enables the PN9 generator. A transition on the DIO pin is required after enabling the PN9 pseudo random sequence.

The PN9 pseudo random sequence is defined by the polynomial  $x^9 + x^5 + 1$ .

The PN9 sequence is 'XOR'ed with the DIO signal in both TX and RX mode as shown in Figure 34. Hence, by transmitting only zeros (DIO = 0), the BER (Bit Error Rate) can be tested by counting the

number of received ones. Note that the 9 first received bits should be discarded in this case. Also note that one bit error will generate 3 received ones.

Transmitting only ones (DIO = 1), the BER can be tested by counting the number of received zeroes.

The PN9 generator can also be used for transmission of 'real-life' data when measuring narrowband ACP (Adjacent Channel Power), modulation bandwidth or occupied bandwidth.

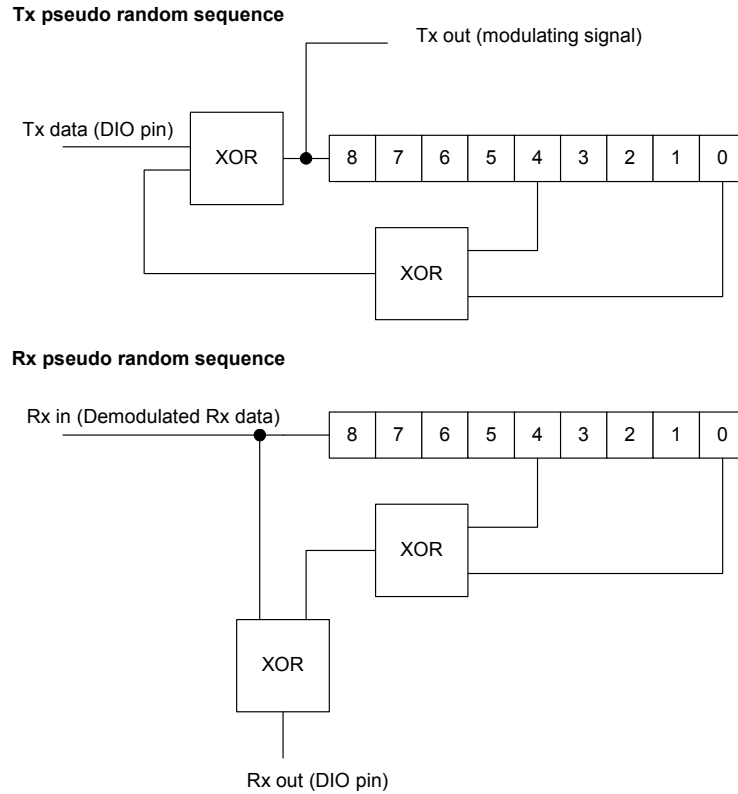


Figure 34. PN9 pseudo random sequence generator in TX and RX mode

## 21. Interrupt on Pin DCLK

### 21.1. Interrupt upon PLL Lock

In synchronous mode the DCLK pin on *CC1020* can be used to give an interrupt signal to wake the microcontroller when the PLL is locked.

*PD\_MODE[1:0]* in the *MAIN* register should be set to 01. If *DCLK\_LOCK* in the *INTERFACE* register is set to 1 the DCLK signal is always logic high if the PLL is not in lock. When the PLL locks to the desired frequency the DCLK signal changes to

logic 0. When this interrupt has been detected write *PD\_MODE[1:0] = 00*. This will enable the DCLK signal.

This function can be used to wait for the PLL to be locked before the PA is ramped up in transmit mode. In receive mode, it can be used to wait until the PLL is locked before searching for preamble.

### 21.2. Interrupt upon Received Signal Carrier Sense

In synchronous mode the DCLK pin on *CC1020* can also be used to give an interrupt signal to the microcontroller when the RSSI level exceeds a certain threshold (carrier sense threshold). This function can be used to wake or interrupt the microcontroller when a strong signal is received.

Gating the DCLK signal with the carrier sense signal makes the interrupt signal.

This function should only be used in receive mode and is enabled by setting *DCLK\_CS = 1* in the *INTERFACE* register.

The DCLK signal is always logic high unless carrier sense is indicated. When carrier sense is indicated the DCLK starts running. When gating the DCLK signal with the carrier sense signal at least 2 dummy bits should be added after the data payload in TX mode. The reason being that the carrier sense signal is generated earlier in the receive chain (i.e. before the

demodulator), causing it to be updated 2 bits before the corresponding data is available on the DIO pin.

In transmit mode *DCLK\_CS* must be set to 0. Refer to *CC1020* Errata Note 002.

## 22. PA\_EN and LNA\_EN Digital Output Pins

### 22.1. Interfacing an External LNA or PA

*CC1020* has two digital output pins, *PA\_EN* and *LNA\_EN*, which can be used to control an external LNA or PA. The functionality of these pins are controlled through the *INTERFACE* register. The outputs can also be used as general digital output control signals.

*EXT\_PA\_POL* and *EXT\_LNA\_POL* control the active polarity of the signals.

*EXT\_PA* and *EXT\_LNA* control the function of the pins. If *EXT\_PA* = 1, then the *PA\_EN* pin will be activated when the

internal PA is turned on. Otherwise, the *EXT\_PA\_POL* bit controls the *PA\_EN* pin directly. If *EXT\_LNA* = 1, then the *LNA\_EN* pin will be activated when the internal LNA is turned on. Otherwise, the *EXT\_LNA\_POL* bit controls the *LNA\_EN* pin directly.

These two pins can therefore also be used as two general control signals, see section 22.2. In the TI reference design *LNA\_EN* and *PA\_EN* are used to control the external T/R switch.

### 22.2. General Purpose Output Control Pins

The two digital output pins, *PA\_EN* and *LNA\_EN*, can be used as two general control signals by setting *EXT\_PA* = 0 and *EXT\_LNA* = 0. The output value is then set directly by the value written to *EXT\_PA\_POL* and *EXT\_LNA\_POL*.

The *LOCK* pin can also be used as a general-purpose output pin. The *LOCK* pin

is controlled by *LOCK\_SELECT[3:0]* in the *LOCK* register. The *LOCK* pin is low when *LOCK\_SELECT[3:0]* = 0000, and high when *LOCK\_SELECT[3:0]* = 0001.

These features can be used to save I/O pins on the microcontroller when the other functions associated with these pins are not used.

### 22.3. PA\_EN and LNA\_EN Pin Drive

Figure 35 shows the *PA\_EN* and *LNA\_EN* pin drive currents. The sink and source

currents have opposite signs but absolute values are used in Figure 35.

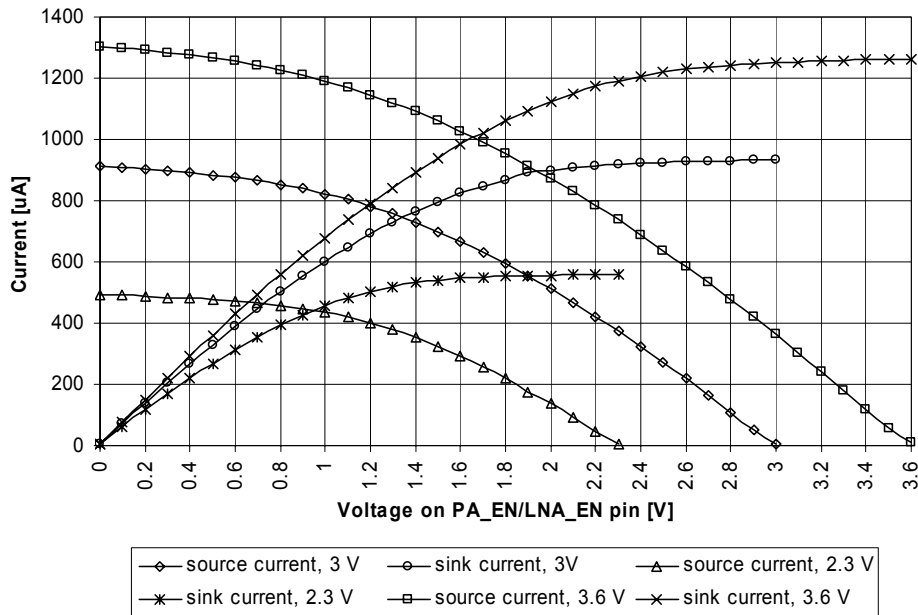


Figure 35. Typical PA\_EN and LNA\_EN pin drive

### 23. System Considerations and Guidelines

#### SRD regulations

International regulations and national laws regulate the use of radio receivers and transmitters. SRDs (Short Range Devices) for license free operation are allowed to operate in the 433 and 868 – 870 MHz bands in most European countries. In the United States, such devices operate in the 260 – 470 and 902 – 928 MHz bands. **CC1020** is also applicable for use in the 950 – 960 MHz frequency band in Japan. A summary of the most important aspects of these regulations can be found in Application Note *AN001 SRD regulations for license free transceiver operation*, available from the TI web site.

#### Narrowband systems

**CC1020** is specifically designed for narrowband systems complying with ARIB STD-T67 and EN 300 220. The **CC1020** meets the strict requirements to ACP (Adjacent Channel Power) and occupied bandwidth for a narrowband transmitter. To meet the ARIB STD-T67 requirements a 3.0 V regulated voltage supply should be used.

For the receiver side, **CC1020** gives very good ACR (Adjacent Channel Rejection), image frequency suppression and blocking

properties for channel spacings down to 12.5 kHz.

Such narrowband performance normally requires the use of external ceramic filters. The **CC1020** provides this performance as a true single-chip solution with integrated IF filters.

Japan and Korea have allocated several frequency bands at 424, 426, 429, 447, 449 and 469 MHz for narrowband license free operation. **CC1020** is designed to meet the requirements for operation in all these bands, including the strict requirements for narrowband operation down to 12.5 kHz channel spacing.

Due to on-chip complex filtering, the image frequency is removed. An on-chip calibration circuit is used to get the best possible image rejection. A narrowband preselector filter is not necessary to achieve image rejection.

A unique feature in **CC1020** is the very fine frequency resolution. This can be used for temperature compensation of the crystal if the temperature drift curve is known and a temperature sensor is included in the system. Even initial adjustment can be performed using the frequency

programmability. This eliminates the need for an expensive TCXO and trimming in some applications. For more details refer to Application Note *AN027 Temperature Compensation* available from the TI web site.

In less demanding applications, a crystal with low temperature drift and low aging could be used without further compensation. A trimmer capacitor in the crystal oscillator circuit (in parallel with C5) could be used to set the initial frequency accurately.

The frequency offset between a transmitter and receiver is measured in the *CC1020* and can be read back from the *AFC* register. The measured frequency offset can be used to calibrate the receiver frequency using the transmitter as the reference. For more details refer to Application Note *AN029 CC1020/1021 AFC* available from the TI web site.

*CC1020* also has the possibility to use Gaussian shaped FSK (GFSK). This spectrum-shaping feature improves adjacent channel power (ACP) and occupied bandwidth. In 'true' FSK systems with abrupt frequency shifting, the spectrum is inherently broad. By making the frequency shift 'softer', the spectrum can be made significantly narrower. Thus, higher data rates can be transmitted in the same bandwidth using GFSK.

### Low cost systems

As the *CC1020* provides true narrowband multi-channel performance without any external filters, a very low cost high performance system can be achieved. The oscillator crystal can then be a low cost crystal with 50 ppm frequency tolerance using the on-chip frequency tuning possibilities.

### Battery operated systems

In low power applications, the power down mode should be used when *CC1020* is not being active. Depending on the start-up time requirement, the oscillator core can be powered during power down. See section 17 on page 54 for information on how effective power management can be implemented.

### High reliability systems

Using a SAW filter as a preselector will improve the communication reliability in harsh environments by reducing the probability of blocking. The receiver sensitivity and the output power will be reduced due to the filter insertion loss. By inserting the filter in the RX path only, together with an external RX/TX switch, only the receiver sensitivity is reduced and output power is remained. The PA\_EN and LNA\_EN pin can be configured to control an external LNA, RX/TX switch or power amplifier. This is controlled by the *INTERFACE* register.

### Frequency hopping spread spectrum systems (FHSS)

Due to the very fast locking properties of the PLL, the *CC1020* is also very suitable for frequency hopping systems. Hop rates of 1-100 hops/s are commonly used depending on the bit rate and the amount of data to be sent during each transmission. The two frequency registers (*FREQ\_A* and *FREQ\_B*) are designed such that the 'next' frequency can be programmed while the 'present' frequency is used. The switching between the two frequencies is done through the *MAIN* register. Several features have been included to do the hopping without a need to re-synchronize the receiver. For more details refer to Application Note *AN014 Frequency Hopping Systems* available from the TI web site.

In order to implement a frequency hopping system with *CC1020* do the following:

Set the desired frequency, calibrate and store the following register settings in non-volatile memory:

```
STATUS1[3:0]: CHP_CURRENT[3:0]
STATUS2[4:0]: VCO_ARRAY[4:0]
STATUS3[5:0]: VCO_CAL_CURRENT[5:0]
```

Repeat the calibration for each desired frequency. *VCO\_CAL\_CURRENT[5:0]* is not dependent on the RF frequency and the same value can be used for all frequencies.

When performing frequency hopping, write the stored values to the corresponding *TEST1*, *TEST2* and *TEST3* registers, and enable override:

```
TEST1[3:0]: CHP_CO[3:0]
TEST2[4:0]: VCO_AO[4:0]
```

TEST2[5]: VCO\_OVERRIDE  
TEST2[6]: CHP\_OVERRIDE  
TEST3[5:0]: VCO\_CO[5:0]  
TEST3[6]: VCO\_CAL\_OVERRIDE

CHP\_CO[3:0] is the register setting read from CHP\_CURRENT[3:0], VCO\_AO[4:0] is the register setting read from VCO\_ARRAY[4:0] and VCO\_CO[5:0] is the register setting read from VCO\_CAL\_CURRENT[5:0].

Assume channel 1 defined by register *FREQ\_A* is currently being used and that **CC1020** should operate on channel 2 next (to change channel simply write to register *MAIN[6]*). The channel 2 frequency can be

set by register *FREQ\_B* which can be written to while operating on channel 1. The calibration data must be written to the *TEST1-3* registers after switching to the next frequency. That is, when hopping to a new channel write to register *MAIN[6]* first and the test registers next. The PA should be switched off between each hop and the PLL should be checked for lock before switching the PA back on after a hop has been performed.

Note that the override bits *VCO\_OVERRIDE*, *CHP\_OVERRIDE* and *VCO\_CAL\_OVERRIDE* must be disabled when performing a re-calibration.

## 24. PCB Layout Recommendations

The top layer should be used for signal routing, and the open areas should be filled with metallization connected to ground using several vias.

The area under the chip is used for grounding and must be connected to the bottom ground plane with several vias. In the TI reference designs we have placed 9 vias inside the exposed die attached pad. These vias should be “tented” (covered with solder mask) on the component side of the PCB to avoid migration of solder through the vias during the solder reflow process.

Do not place a via underneath **CC1020** at “pin #1 corner” as this pin is internally connected to the exposed die attached pad, which is the main ground connection for the chip.

Each decoupling capacitor should be placed as close as possible to the supply pin it is supposed to decouple. Each decoupling capacitor should be connected to the power line (or power plane) by separate vias. The best routing is from the power line (or power plane) to the

decoupling capacitor and then to the **CC1020** supply pin. Supply power filtering is very important, especially for pins 23, 22, 20 and 18.

Each decoupling capacitor ground pad should be connected to the ground plane using a separate via. Direct connections between neighboring power pins will increase noise coupling and should be avoided unless absolutely necessary.

The external components should ideally be as small as possible and surface mount devices are highly recommended.

Precaution should be used when placing the microcontroller in order to avoid noise interfering with the RF circuitry.

A CC1020/1070DK Development Kit with a fully assembled CC1020EMX Evaluation Module is available. It is strongly advised that this reference layout is followed very closely in order to get the best performance. The layout Gerber files are available from the TI web site.



**25. Antenna Considerations**

*CC1020* can be used together with various types of antennas. The most common antennas for short-range communication are monopole, helical and loop antennas.

Monopole antennas are resonant antennas with a length corresponding to one quarter of the electrical wavelength ( $\lambda/4$ ). They are very easy to design and can be implemented simply as a “piece of wire” or even integrated onto the PCB.

Non-resonant monopole antennas shorter than  $\lambda/4$  can also be used, but at the expense of range. In size and cost critical applications such an antenna may very well be integrated onto the PCB.

Helical antennas can be thought of as a combination of a monopole and a loop antenna. They are a good compromise in size critical applications. But helical antennas tend to be more difficult to optimize than the simple monopole.

Loop antennas are easy to integrate into the PCB, but are less effective due to

difficult impedance matching because of their very low radiation resistance.

For low power applications the  $\lambda/4$ -monopole antenna is recommended due to its simplicity as well as providing the best range.

The length of the  $\lambda/4$ -monopole antenna is given by:

$$L = 7125 / f$$

where f is in MHz, giving the length in cm. An antenna for 868 MHz should be 8.2 cm, and 16.4 cm for 433 MHz.

The antenna should be connected as close as possible to the IC. If the antenna is located away from the input pin the antenna should be matched to the feeding transmission line (50  $\Omega$ ).

For a more thorough background on antennas, please refer to Application Note *AN003 SRD Antennas* available from the TI web site.

**26. Configuration Registers**

The configuration of *CC1020* is done by programming the 8-bit configuration registers. The configuration data based on selected system parameters are most easily found by using the SmartRF® Studio software. Complete descriptions of the registers are given in the following tables. After a RESET is programmed, all the registers have default values. The *TEST* registers also get default values after a

RESET, and should not be altered by the user.

TI recommends using the register settings found using the SmartRF® Studio software. These are the register settings that TI specifies across temperature, voltage and process. Please check the TI web site for regularly updates to the SmartRF® Studio software.

## 26.1. CC1020 Register Overview

| ADDRESS | Byte Name    | Description  |
|---------|--------------|--|
| 00h     | MAIN         | Main control register  |
| 01h     | INTERFACE    | Interface control register   |
| 02h     | RESET        | Digital module reset register  |
| 03h     | SEQUENCING   | Automatic power-up sequencing control register                           |
| 04h     | FREQ_2A      | Frequency register 2A  |
| 05h     | FREQ_1A      | Frequency register 1A  |
| 06h     | FREQ_0A      | Frequency register 0A  |
| 07h     | CLOCK_A      | Clock generation register A  |
| 08h     | FREQ_2B      | Frequency register 2B  |
| 09h     | FREQ_1B      | Frequency register 1B  |
| 0Ah     | FREQ_0B      | Frequency register 0B  |
| 0Bh     | CLOCK_B      | Clock generation register B  |
| 0Ch     | VCO          | VCO current control register   |
| 0Dh     | MODEM        | Modem control register   |
| 0Eh     | DEVIATION    | TX frequency deviation register  |
| 0Fh     | AFC_CONTROL  | RX AFC control register  |
| 10h     | FILTER       | Channel filter / RSSI control register                                   |
| 11h     | VGA1         | VGA control register 1   |
| 12h     | VGA2         | VGA control register 2   |
| 13h     | VGA3         | VGA control register 3   |
| 14h     | VGA4         | VGA control register 4   |
| 15h     | LOCK         | Lock control register  |
| 16h     | FRONTEND     | Front end bias current control register                                  |
| 17h     | ANALOG       | Analog modules control register  |
| 18h     | BUFF_SWING   | LO buffer and prescaler swing control register                           |
| 19h     | BUFF_CURRENT | LO buffer and prescaler bias current control register                    |
| 1Ah     | PLL_BW       | PLL loop bandwidth / charge pump current control register                |
| 1Bh     | CALIBRATE    | PLL calibration control register   |
| 1Ch     | PA_POWER     | Power amplifier output power register                                    |
| 1Dh     | MATCH        | Match capacitor array control register, for RX and TX impedance matching |
| 1Eh     | PHASE_COMP   | Phase error compensation control register for LO I/Q                     |
| 1Fh     | GAIN_COMP    | Gain error compensation control register for mixer I/Q                   |
| 20h     | POWERDOWN    | Power-down control register  |
| 21h     | TEST1        | Test register for overriding PLL calibration                             |
| 22h     | TEST2        | Test register for overriding PLL calibration                             |
| 23h     | TEST3        | Test register for overriding PLL calibration                             |
| 24h     | TEST4        | Test register for charge pump and IF chain testing                       |
| 25h     | TEST5        | Test register for ADC testing  |
| 26h     | TEST6        | Test register for VGA testing  |
| 27h     | TEST7        | Test register for VGA testing  |
| 40h     | STATUS       | Status information register (PLL lock, RSSI, calibration ready, etc.)    |
| 41h     | RESET_DONE   | Status register for digital module reset                                 |
| 42h     | RSSI         | Received signal strength register  |
| 43h     | AFC          | Average received frequency deviation from IF (can be used for AFC)       |
| 44h     | GAUSS_FILTER | Digital FM demodulator register  |
| 45h     | STATUS1      | Status of PLL calibration results etc. (test only)                       |
| 46h     | STATUS2      | Status of PLL calibration results etc. (test only)                       |
| 47h     | STATUS3      | Status of PLL calibration results etc. (test only)                       |
| 48h     | STATUS4      | Status of ADC signals (test only)  |
| 49h     | STATUS5      | Status of channel filter "I" signal (test only)                          |
| 4Ah     | STATUS6      | Status of channel filter "Q" signal (test only)                          |
| 4Bh     | STATUS7      | Status of AGC (test only)  |

## MAIN Register (00h)

| REGISTER  | NAME          | Default value | Active | Description   |
|-----------|---------------|---------------|--------|---|
| MAIN[7]   | RXTX          | -             | -      | RX/TX switch, 0: RX , 1: TX   |
| MAIN[6]   | F_REG         | -             | -      | Selection of Frequency Register, 0: Register A, 1: Register B   |
| MAIN[5:4] | PD_MODE[1 :0] | -             | -      | Power down mode<br>0 (00): Receive Chain in power-down in TX, PA in power-down in RX<br>1 (01): Receive Chain and PA in power-down in both TX and RX<br>2 (10): Individual modules can be put in power-down by programming the POWERDOWN register<br>3 (11): Automatic power-up sequencing is activated (see below) |
| MAIN[3]   | FS_PD         | -             | H      | Power Down of Frequency Synthesizer   |
| MAIN[2]   | XOSC_PD       | -             | H      | Power Down of Crystal Oscillator Core   |
| MAIN[1]   | BIAS_PD       | -             | H      | Power Down of BIAS (Global Current Generator) and Crystal Oscillator Buffer   |
| MAIN[0]   | RESET_N       | -             | L      | Reset, active low. Writing RESET_N low will write default values to all other registers than MAIN. Bits in MAIN do not have a default value and will be written directly through the configuration interface. Must be set high to complete reset.   |

## MAIN Register (00h) when using automatic power-up sequencing (RXTX = 0, PD\_MODE[1:0] =11)

| REGISTER   | NAME          | Default value | Active | Description   |
|------------|---------------|---------------|--------|---|
| MAIN[7]    | RXTX          | -             | -      | Automatic power-up sequencing only works in RX (RXTX=0)   |
| MAIN[6]    | F_REG         | -             | -      | Selection of Frequency Register, 0: Register A, 1: Register B   |
| MAIN[5 :4] | PD_MODE[1 :0] | -             | H      | Set PD_MODE[1:0]=3 (11) to enable sequencing  |
| MAIN[3:2]  | SEQ_CAL[1:0]  | -             | -      | Controls PLL calibration before re-entering power-down<br>0: Never perform PLL calibration as part of sequence<br>1: Always perform PLL calibration at end of sequence<br>2: Perform PLL calibration at end of every 16 <sup>th</sup> sequence<br>3: Perform PLL calibration at end of every 256 <sup>th</sup> sequence |
| MAIN[1]    | SEQ_PD        | -             | ↑      | ↑1: Put the chip in power down and wait for start of new power-up sequence  |
| MAIN[0]    | RESET_N       | -             | L      | Reset, active low. Writing RESET_N low will write default values to all other registers than MAIN. Bits in MAIN do not have a default value and will be written directly through the configuration interface. Must be set high to complete reset.   |

## INTERFACE Register (01h)

| REGISTER     | NAME        | Default value | Active | Description   |
|--------------|-------------|---------------|--------|---|
| INTERFACE[7] | XOSC_BYPASS | 0             | H      | Bypass internal crystal oscillator, use external clock<br>0: Internal crystal oscillator is used, or external sine wave fed through a coupling capacitor<br>1: Internal crystal oscillator in power down, external clock with rail-to-rail swing is used  |
| INTERFACE[6] | SEP_DI_DO   | 0             | H      | Use separate pin for RX data output<br>0: DIO is data output in RX and data input in TX. LOCK pin is available (Normal operation).<br>1: DIO is always input, and a separate pin is used for RX data output (synchronous mode: LOCK pin, asynchronous mode: DCLK pin).<br><br>If SEP_DI_DO=1 and SEQ_PSEL=0 in SEQUENCING register then negative transitions on DIO is used to start power-up sequencing when PD_MODE=3 (power-up sequencing is enabled). |
| INTERFACE[5] | DCLK_LOCK   | 0             | H      | Gate DCLK signal with PLL lock signal in synchronous mode<br>Only applies when PD_MODE = "01"<br>0: DCLK is always 1<br>1: DCLK is always 1 unless PLL is in lock   |
| INTERFACE[4] | DCLK_CS     | 0             | H      | Gate DCLK signal with carrier sense indicator in synchronous mode<br>Use when receive chain is active (in power-up)<br>Always set to 0 in TX mode.<br>0: DCLK is independent of carrier sense indicator.<br>1: DCLK is always 1 unless carrier sense is indicated   |
| INTERFACE[3] | EXT_PA      | 0             | H      | Use PA_EN pin to control external PA<br>0: PA_EN pin always equals EXT_PA_POL bit<br>1: PA_EN pin is asserted when internal PA is turned on   |
| INTERFACE[2] | EXT_LNA     | 0             | H      | Use LNA_EN pin to control external LNA<br>0: LNA_EN pin always equals EXT_LNA_POL bit<br>1: LNA_EN pin is asserted when internal LNA is turned on   |
| INTERFACE[1] | EXT_PA_POL  | 0             | H      | Polarity of external PA control<br>0: PA_EN pin is "0" when activating external PA<br>1: PA_EN pin is "1" when activating external PA   |
| INTERFACE[0] | EXT_LNA_POL | 0             | H      | Polarity of external LNA control<br>0: LNA_EN pin is "0" when activating external LNA<br>1: LNA_EN pin is "1" when activating external LNA  |

Note: If *TF\_ENABLE=1* or *TA\_ENABLE=1* in *TEST4* register, then *INTERFACE[3:0]* controls analog test module: *INTERFACE[3] = TEST\_PD*, *INTERFACE[2:0] = TEST\_MODE[2:0]*. Otherwise, *TEST\_PD=1* and *TEST\_MODE[2:0]=001*.

## RESET Register (02h)

| REGISTER | NAME             | Default value | Active | Description   |
|----------|------------------|---------------|--------|---|
| RESET[7] | ADC_RESET_N      | 0             | L      | Reset ADC control logic   |
| RESET[6] | AGC_RESET_N      | 0             | L      | Reset AGC (VGA control) logic                                     |
| RESET[5] | GAUSS_RESET_N    | 0             | L      | Reset Gaussian data filter  |
| RESET[4] | AFC_RESET_N      | 0             | L      | Reset AFC / FSK decision level logic                              |
| RESET[3] | BITSYNC_RESET_N  | 0             | L      | Reset modulator, bit synchronization logic and PN9 PRBS generator |
| RESET[2] | SYNTH_RESET_N    | 0             | L      | Reset digital part of frequency synthesizer                       |
| RESET[1] | SEQ_RESET_N      | 0             | L      | Reset power-up sequencing logic                                   |
| RESET[0] | CAL_LOCK_RESET_N | 0             | L      | Reset calibration logic and lock detector                         |

Note: For reset of CC1020 write *RESET\_N=0* in the *MAIN* register. The reset register should not be used during normal operation.

Bits in the *RESET* register are self-clearing (will be set to 1 when the reset operation starts). Relevant digital clocks must be running for the resetting to complete. After writing to the *RESET* register, the user should verify that all reset operations have been completed, by reading the *RESET\_DONE* status register (41h) until all bits equal 1.

## SEQUENCING Register (03h)

| REGISTER        | NAME         | Default value | Active | Description   |
|-----------------|--------------|---------------|--------|---|
| SEQUENCING[7]   | SEQ_PSEL     | 1             | H      | Use PSEL pin to start sequencing<br>0: PSEL pin does not start sequencing. Negative transitions on DIO starts power-up sequencing if SEP_DI_DO=1.<br>1: Negative transitions on the PSEL pin will start power-up sequencing   |
| SEQUENCING[6:4] | RX_WAIT[2:0] | 0             | -      | Waiting time from PLL enters lock until RX power-up<br>0: Wait for approx. 32 ADC_CLK periods (26 µs)<br>1: Wait for approx. 44 ADC_CLK periods (36 µs)<br>2: Wait for approx. 64 ADC_CLK periods (52 µs)<br>3: Wait for approx. 88 ADC_CLK periods (72 µs)<br>4: Wait for approx. 128 ADC_CLK periods (104 µs)<br>5: Wait for approx. 176 ADC_CLK periods (143 µs)<br>6: Wait for approx. 256 ADC_CLK periods (208 µs)<br>7: No additional waiting time before RX power-up   |
| SEQUENCING[3:0] | CS_WAIT[3:0] | 10            | -      | Waiting time for carrier sense from RX power-up<br>0: Wait 20 FILTER_CLK periods before power down<br>1: Wait 22 FILTER_CLK periods before power down<br>2: Wait 24 FILTER_CLK periods before power down<br>3: Wait 26 FILTER_CLK periods before power down<br>4: Wait 28 FILTER_CLK periods before power down<br>5: Wait 30 FILTER_CLK periods before power down<br>6: Wait 32 FILTER_CLK periods before power down<br>7: Wait 36 FILTER_CLK periods before power down<br>8: Wait 40 FILTER_CLK periods before power down<br>9: Wait 44 FILTER_CLK periods before power down<br>10: Wait 48 FILTER_CLK periods before power down<br>11: Wait 52 FILTER_CLK periods before power down<br>12: Wait 56 FILTER_CLK periods before power down<br>13: Wait 60 FILTER_CLK periods before power down<br>14: Wait 64 FILTER_CLK periods before power down<br>15: Wait 72 FILTER_CLK periods before power down |

## FREQ\_2A Register (04h)

| REGISTER     | NAME          | Default value | Active | Description                       |
|--------------|---------------|---------------|--------|-----------------------------------|
| FREQ_2A[7:0] | FREQ_A[22:15] | 131           | -      | 8 MSB of frequency control word A |

## FREQ\_1A Register (05h)

| REGISTER     | NAME         | Default value | Active | Description                             |
|--------------|--------------|---------------|--------|---|
| FREQ_1A[7:0] | FREQ_A[14:7] | 177           | -      | Bit 15 to 8 of frequency control word A |

## FREQ\_0A Register (06h)

| REGISTER     | NAME        | Default value | Active | Description                       |
|--------------|-------------|---------------|--------|-----------------------------------|
| FREQ_0A[7:1] | FREQ_A[6:0] | 124           | -      | 7 LSB of frequency control word A |
| FREQ_0A[0]   | DITHER_A    | 1             | H      | Enable dithering for frequency A  |

## CLOCK\_A Register (07h)

| REGISTER     | NAME             | Default value | Active | Description   |
|--------------|------------------|---------------|--------|---|
| CLOCK_A[7:5] | REF_DIV_A[2:0]   | 2             | -      | Reference frequency divisor (A):<br>0: Not supported<br>1: REF_CLK frequency = Crystal frequency / 2<br>...<br>7: REF_CLK frequency = Crystal frequency / 8<br><br>It is recommended to use the highest possible reference clock frequency that allows the desired Baud rate. |
| CLOCK_A[4:2] | MCLK_DIV1_A[2:0] | 4             | -      | Modem clock divider 1 (A):<br>0: Divide by 2.5<br>1: Divide by 3<br>2: Divide by 4<br>3: Divide by 7.5 (2.5·3)<br>4: Divide by 12.5 (2.5·5)<br>5: Divide by 40 (2.5·16)<br>6: Divide by 48 (3·16)<br>7: Divide by 64 (4·16)   |
| CLOCK_A[1:0] | MCLK_DIV2_A[1:0] | 0             | -      | Modem clock divider 2 (A):<br>0: Divide by 1<br>1: Divide by 2<br>2: Divide by 4<br>3: Divide by 8<br><br>MODEM_CLK frequency is FREF frequency divided by the product of divider 1 and divider 2.<br><br>Baud rate is MODEM_CLK frequency divided by 8.                      |

## FREQ\_2B Register (08h)

| REGISTER     | NAME          | Default value | Active | Description                       |
|--------------|---------------|---------------|--------|-----------------------------------|
| FREQ_2B[7:0] | FREQ_B[22:15] | 131           | -      | 8 MSB of frequency control word B |

## FREQ\_1B Register (09h)

| REGISTER     | NAME         | Default value | Active | Description                             |
|--------------|--------------|---------------|--------|---|
| FREQ_1B[7:0] | FREQ_B[14:7] | 189           | -      | Bit 15 to 8 of frequency control word B |

## FREQ\_0B Register (0Ah)

| REGISTER     | NAME        | Default value | Active | Description                       |
|--------------|-------------|---------------|--------|-----------------------------------|
| FREQ_0B[7:1] | FREQ_B[6:0] | 124           | -      | 7 LSB of frequency control word B |
| FREQ_0B[0]   | DITHER_B    | 1             | H      | Enable dithering for frequency B  |

## CLOCK\_B Register (0Bh)

| REGISTER     | NAME             | Default value | Active | Description  |
|--------------|------------------|---------------|--------|--|
| CLOCK_B[7:5] | REF_DIV_B[2:0]   | 2             | -      | Reference frequency divisor (B):<br>0: Not supported<br>1: REF_CLK frequency = Crystal frequency / 2<br>...<br>7: REF_CLK frequency = Crystal frequency / 8  |
| CLOCK_B[4:2] | MCLK_DIV1_B[2:0] | 4             | -      | Modem clock divider 1 (B):<br>0: Divide by 2.5<br>1: Divide by 3<br>2: Divide by 4<br>3: Divide by 7.5 (2.5·3)<br>4: Divide by 12.5 (2.5·5)<br>5: Divide by 40 (2.5·16)<br>6: Divide by 48 (3·16)<br>7: Divide by 64 (4·16)                              |
| CLOCK_B[1:0] | MCLK_DIV2_B[1:0] | 0             | -      | Modem clock divider 2 (B):<br>0: Divide by 1<br>1: Divide by 2<br>2: Divide by 4<br>3: Divide by 8<br><br>MODEM_CLK frequency is FREF frequency divided by the product of divider 1 and divider 2.<br><br>Baud rate is MODEM_CLK frequency divided by 8. |

## VCO Register (0Ch)

| REGISTER | NAME               | Default value | Active | Description  |
|----------|--------------------|---------------|--------|--|
| VCO[7:4] | VCO_CURRENT_A[3:0] | 8             | -      | Control of current in VCO core for frequency A<br>0 : 1.4 mA current in VCO core<br>1 : 1.8 mA current in VCO core<br>2 : 2.1 mA current in VCO core<br>3 : 2.5 mA current in VCO core<br>4 : 2.8 mA current in VCO core<br>5 : 3.2 mA current in VCO core<br>6 : 3.5 mA current in VCO core<br>7 : 3.9 mA current in VCO core<br>8 : 4.2 mA current in VCO core<br>9 : 4.6 mA current in VCO core<br>10 : 4.9 mA current in VCO core<br>11 : 5.3 mA current in VCO core<br>12 : 5.6 mA current in VCO core<br>13 : 6.0 mA current in VCO core<br>14 : 6.4 mA current in VCO core<br>15 : 6.7 mA current in VCO core<br><br>Recommended setting: VCO_CURRENT_A=4 |
| VCO[3:0] | VCO_CURRENT_B[3:0] | 8             | -      | Control of current in VCO core for frequency B<br>The current steps are the same as for VCO_CURRENT_A<br><br>Recommended setting: VCO_CURRENT_B=4  |

## MODEM Register (0Dh)

| REGISTER   | NAME             | Default value | Active | Description   |
|------------|------------------|---------------|--------|---|
| MODEM[7]   | -                | 0             | -      | Reserved, write 0   |
| MODEM[6:4] | ADC_DIV[2:0]     | 3             | -      | <p>ADC clock divisor</p> <p>0: Not supported<br/>           1: ADC frequency = XOSC frequency / 4<br/>           2: ADC frequency = XOSC frequency / 6<br/>           3: ADC frequency = XOSC frequency / 8<br/>           4: ADC frequency = XOSC frequency / 10<br/>           5: ADC frequency = XOSC frequency / 12<br/>           6: ADC frequency = XOSC frequency / 14<br/>           7: ADC frequency = XOSC frequency / 16</p> <p>Note that the intermediate frequency should be as close to 307.2 kHz as possible. ADC clock frequency is always 4 times the intermediate frequency and should therefore be as close to 1.2288 MHz as possible.</p> |
| MODEM[3]   | -                | 0             | -      | Reserved, write 0   |
| MODEM[2]   | PN9_ENABLE       | 0             | H      | <p>Enable scrambling of TX and RX with PN9 pseudo-random bit sequence</p> <p>0: PN9 scrambling is disabled<br/>           1: PN9 scrambling is enabled (<math>x^9+x^5+1</math>)</p> <p>The PN9 pseudo-random bit sequence can be used for BER testing by only transmitting zeros, and then counting the number of received ones.</p>  |
| MODEM[1:0] | DATA_FORMAT[1:0] | 0             | -      | <p>Modem data format</p> <p>0 (00): NRZ operation<br/>           1 (01): Manchester operation<br/>           2 (10): Transparent asynchronous UART operation, set DCLK=0<br/>           3 (11): Transparent asynchronous UART operation, set DCLK=1</p>   |

## DEVIATION Register (0Eh)

| REGISTER         | NAME          | Default value | Active | Description  |
|------------------|---------------|---------------|--------|--|
| DEVIATION[7]     | TX_SHAPING    | 1             | H      | Enable Gaussian shaping of transmitted data<br>Recommended setting: TX_SHAPING=1   |
| DEVIATION[6 :4]  | TXDEV_X[2 :0] | 6             | -      | Transmit frequency deviation exponent  |
| DEVIATION [3 :0] | TXDEV_M[3 :0] | 8             | -      | <p>Transmit frequency deviation mantissa</p> <p>Deviation in 402-470 MHz band:<br/> <math>F_{REF} \cdot TXDEV\_M \cdot 2^{(TXDEV\_X-16)}</math></p> <p>Deviation in 804-960 MHz band:<br/> <math>F_{REF} \cdot TXDEV\_M \cdot 2^{(TXDEV\_X-15)}</math></p> <p>On-off-keying (OOK) is used in RX/TX if TXDEV_M[3:0]=0</p> <p>To find TXDEV_M given the deviation and TXDEV_X:</p> <p><math>TXDEV\_M = deviation \cdot 2^{(16-TXDEV\_X)} / F_{REF}</math><br/>           in 402-470 MHz band,</p> <p><math>TXDEV\_M = deviation \cdot 2^{(15-TXDEV\_X)} / F_{REF}</math><br/>           in 804-960 MHz band.</p> <p>Decrease TXDEV_X and try again if TXDEV_M &lt; 8.<br/>           Increase TXDEV_X and try again if TXDEV_M ≥ 16.</p> |



## AFC\_CONTROL Register (0Fh)

| REGISTER         | NAME          | Default value | Active | Description  |
|------------------|---------------|---------------|--------|--|
| AFC_CONTROL[7:6] | SETTLING[1:0] | 2             | -      | Controls AFC settling time versus accuracy<br>0: AFC off; zero average frequency is used in demodulator<br>1: Fastest settling; frequency averaged over 1 0/1 bit pair<br>2: Medium settling; frequency averaged over 2 0/1 bit pairs<br>3: Slowest settling; frequency averaged over 4 0/1 bit pairs<br><br>Recommended setting: AFC_CONTROL=3 for higher accuracy unless it is essential to have the fastest settling time when transmission starts after RX is activated. |
| AFC_CONTROL[5:4] | RXDEV_X[1:0]  | 1             | -      | RX frequency deviation exponent  |
| AFC_CONTROL[3:0] | RXDEV_M[3:0]  | 12            | -      | RX frequency deviation mantissa<br><br>Expected RX deviation should be:<br>$Baud\ rate \cdot RXDEV\_M \cdot 2^{(RXDEV\_X-3)} / 3$<br><br>To find RXDEV_M given the deviation and RXDEV_X:<br>$RXDEV\_M = 3 \cdot deviation \cdot 2^{(3-RXDEV\_X)} / Baud\ rate$<br><br>Decrease RXDEV_X and try again if RXDEV_M < 8.<br>Increase RXDEV_X and try again if RXDEV_M ≥ 16.   |

Note: The RX frequency deviation should be close to half the TX frequency deviation for GFSK at 100 kBaud data rate and below. The RX frequency deviation should be close to the TX frequency deviation for FSK and for GFSK at 100 kBaud data rate and above.

## FILTER Register (10h)

| REGISTER    | NAME           | Default value | Active | Description  |
|-------------|----------------|---------------|--------|--|
| FILTER[7]   | FILTER_BYPASS  | 0             | H      | Bypass analog image rejection / anti-alias filter. Set to 1 for increased dynamic range at high Baud rates.<br><br>Recommended setting:<br>FILTER_BYPASS=0 below 76.8 kBaud,<br>FILTER_BYPASS=1 for 76.8 kBaud and up.   |
| FILTER[6:5] | DEC_SHIFT[1:0] | 0             | -      | Number of extra bits to shift decimator input (may improve filter accuracy and lower power consumption).<br><br>Recommended settings:<br>DEC_SHIFT=0 when DEC_DIV ≤ 1 (receiver channel bandwidth ≥ 153.6 kHz),<br>DEC_SHIFT=1 when optimized sensitivity and 1 < DEC_DIV < 24 (12.29 kHz < receiver channel bandwidth < 153.6 kHz),<br>DEC_SHIFT=2 when optimized selectivity and DEC_DIV ≥ 24 (receiver channel bandwidth ≤ 12.29 kHz) |
| FILTER[4:0] | DEC_DIV[4:0]   | 0             | -      | Decimation clock divisor<br>0: Decimation clock divisor = 1, 307.2 kHz channel filter BW.<br>1: Decimation clock divisor = 2, 153.6 kHz channel filter BW.<br>...<br>30: Decimation clock divisor = 31, 9.91 kHz channel filter BW.<br>31: Decimation clock divisor = 32, 9.6 kHz channel filter BW.<br><br>Channel filter bandwidth is 307.2 kHz divided by the decimation clock divisor.   |

VGA1 Register (11h)

| REGISTER   | NAME            | Default value | Active | Description   |
|------------|-----------------|---------------|--------|---|
| VGA1[7 :6] | CS_SET[1:0]     | 1             | -      | <p>Sets the number of consecutive samples at or above carrier sense level before carrier sense is indicated (e.g. on LOCK pin)</p> <p>0: Set carrier sense after first sample at or above carrier sense level<br/>           1: Set carrier sense after second sample at or above carrier sense level<br/>           2: Set carrier sense after third sample at or above carrier sense level<br/>           3: Set carrier sense after fourth sample at or above carrier sense level</p> <p>Increasing CS_SET reduces the number of "false" carrier sense events due to noise at the expense of increased carrier sense response time.</p>  |
| VGA1[5]    | CS_RESET        | 1             | -      | <p>Sets the number of consecutive samples below carrier sense level before carrier sense indication (e.g. on lock pin) is reset</p> <p>0: Carrier sense is reset after first sample below carrier sense level<br/>           1: Carrier sense is reset after second sample below carrier sense level</p> <p>Recommended setting: CS_RESET=1 in order to reduce the chance of losing carrier sense due to noise.</p>   |
| VGA1[4 :2] | VGA_WAIT[2 :0]  | 1             | -      | <p>Controls how long AGC, bit synchronization, AFC and RSSI levels are frozen after VGA gain is changed when frequency is changed between A and B or PLL has been out of lock or after RX power-up</p> <p>0: Freeze operation for 16 filter clocks, 8/(filter BW) seconds<br/>           1: Freeze operation for 20 filter clocks, 10/(filter BW) seconds<br/>           2: Freeze operation for 24 filter clocks, 12/(filter BW) seconds<br/>           3: Freeze operation for 28 filter clocks, 14/(filter BW) seconds<br/>           4: Freeze operation for 32 filter clocks, 16/(filter BW) seconds<br/>           5: Freeze operation for 40 filter clocks, 20/(filter BW) seconds<br/>           6: Freeze operation for 48 filter clocks, 24/(filter BW) seconds<br/>           7: Freeze present levels unconditionally</p> |
| VGA1[1:0]  | VGA_FREEZE[1:0] | 1             | -      | <p>Controls the additional time AGC, bit synchronization, AFC and RSSI levels are frozen when frequency is changed between A and B or PLL has been out of lock or after RX power-up</p> <p>0: Freeze levels for approx. 16 ADC_CLK periods (13 μs)<br/>           1: Freeze levels for approx. 32 ADC_CLK periods (26 μs)<br/>           2: Freeze levels for approx. 64 ADC_CLK periods (52 μs)<br/>           3: Freeze levels for approx. 128 ADC_CLK periods (104 μs)</p>   |

VGA2 Register (12h)

| REGISTER  | NAME              | Default value | Active | Description  |
|-----------|-------------------|---------------|--------|--|
| VGA2[7]   | LNA2_MIN          | 0             | -      | Minimum LNA2 setting used in VGA<br>0: Minimum LNA2 gain<br>1: Medium LNA2 gain<br><br>Recommended setting: LNA2_MIN=0 for best selectivity.   |
| VGA2[6]   | LNA2_MAX          | 1             | -      | Maximum LNA2 setting used in VGA<br>0: Medium LNA2 gain<br>1: Maximum LNA2 gain<br><br>Recommended setting: LNA2_MAX=1 for best sensitivity.   |
| VGA2[5:4] | LNA2_SETTING[1:0] | 3             | -      | Selects at what VGA setting the LNA gain should be changed<br>0: Apply LNA2 change below min. VGA setting.<br>1: Apply LNA2 change at approx. 1/3 VGA setting (around VGA setting 10).<br>2: Apply LNA2 change at approx. 2/3 VGA setting (around VGA setting 19).<br>3: Apply LNA2 change above max. VGA setting.<br><br>Recommended setting:<br>LNA2_SETTING=0 if VGA_SETTING<10,<br>LNA2_SETTING=1 otherwise.<br><br>If LNA2_MIN=1 and LNA2_MAX=0, then the LNA2 setting is controlled by LNA2_SETTING:<br>0: Between medium and maximum LNA2 gain<br>1: Minimum LNA2 gain<br>2: Medium LNA2 gain<br>3: Maximum LNA2 gain |
| VGA2[3]   | AGC_DISABLE       | 0             | H      | Disable AGC<br>0: AGC is enabled<br>1: AGC is disabled (VGA_SETTING determines VGA gain)<br><br>Recommended setting: AGC_DISABLE=0 for good dynamic range.   |
| VGA2[2]   | AGC_HYSTERESIS    | 1             | H      | Enable AGC hysteresis<br>0: No hysteresis. Immediate gain change for smallest up/down step<br>1: Hysteresis enabled. Two samples in a row must indicate gain change for smallest up/down step<br><br>Recommended setting: AGC_HYSTERESIS=1.  |
| VGA2[1:0] | AGC_AVG[1:0]      | 1             | -      | Sets how many samples that are used to calculate average output magnitude for AGC/RSSI.<br>0: Magnitude is averaged over 2 filter output samples<br>1: Magnitude is averaged over 4 filter output samples<br>2: Magnitude is averaged over 8 filter output samples<br>3: Magnitude is averaged over 16 filter output samples<br><br>Recommended setting: AGC_AVG=1.<br>For best AGC/RSSI accuracy AGC_AVG=3.<br><br>For automatic power-up sequencing, the AGC_AVG and CS_SET values must be chosen so that carrier sense is available in time to be detected before the chip re-enters power-down.                          |

## VGA3 Register (13h)

| REGISTER   | NAME             | Default value | Active | Description   |
|------------|------------------|---------------|--------|---|
| VGA3[7 :5] | VGA_DOWN[2:0]    | 1             | -      | Decides how much the signal strength must be above CS_LEVEL+VGA_UP before VGA gain is decreased. Based on the calculated internal strength level, which has an LSB resolution of 1.5 dB.<br>0: Gain is decreased when level is above CS_LEVEL+ 8 + VGA_UP + 3<br>1: Gain is decreased when level is above CS_LEVEL+ 8 + VGA_UP + 4<br>...<br>6: Gain is decreased when level is above CS_LEVEL+ 8 + VGA_UP + 9<br>7: Gain is decreased when level is above CS_LEVEL+ 8 + VGA_UP + 10<br><br>See Figure 18 on page 38 for an explanation of the relationship between RSSI, AGC and carrier sense settings. |
| VGA3[4:0]  | VGA_SETTING[4:0] | 24            | H      | VGA setting to be used when receive chain is turned on<br>This is also the maximum gain that the AGC is allowed to use.<br><br>See Figure 18 on page 38 for an explanation of the relationship between RSSI, AGC and carrier sense settings.  |

## VGA4 Register (14h)

| REGISTER   | NAME          | Default value | Active | Description   |
|------------|---------------|---------------|--------|---|
| VGA4[7 :5] | VGA_UP[2:0]   | 1             | -      | Decides the level where VGA gain is increased if it is not already at the maximum set by VGA_SETTING. Based on the calculated internal strength level, which has an LSB resolution of 1.5 dB.<br>0: Gain is increased when signal is below CS_LEVEL + 8<br>1: Gain is increased when signal is below CS_LEVEL+ 8 + 1<br>...<br>6: Gain is increased when signal is below CS_LEVEL+ 8 + 6<br>7: Gain is increased when signal below CS_LEVEL+ 8 + 7<br><br>See Figure 18 on page 38 for an explanation of the relationship between RSSI, AGC and carrier sense settings. |
| VGA4[4:0]  | CS_LEVEL[4:0] | 24            | H      | Reference level for Received Signal Strength Indication (carrier sense level) and AGC.<br><br>See Figure 18 on page 38 for an explanation of the relationship between RSSI, AGC and carrier sense settings.   |

## LOCK Register (15h)

| REGISTER  | NAME               | Default value | Active | Description   |
|-----------|--------------------|---------------|--------|---|
| LOCK[7:4] | LOCK_SELECT[3:0]   | 0             | -      | Selection of signals to LOCK pin<br>0: Set to 0<br>1: Set to 1<br>2: LOCK_CONTINUOUS (active low)<br>3: LOCK_INSTANT (active low)<br>4: CARRIER_SENSE (RSSI above threshold, active low)<br>5: CAL_COMPLETE (active low)<br>6: SEQ_ERROR (active low)<br>7: FXOSC<br>8: REF_CLK<br>9: FILTER_CLK<br>10: DEC_CLK<br>11: PRE_CLK<br>12: DS_CLK<br>13: MODEM_CLK<br>14: VCO_CAL_COMP<br>15: F_COMP |
| LOCK[3]   | WINDOW_WIDTH       | 0             | -      | Selects lock window width<br>0: Lock window is 2 prescaler clock cycles wide<br>1: Lock window is 4 prescaler clock cycles wide<br><br>Recommended setting: WINDOW_WIDTH=0.   |
| LOCK[2]   | LOCK_MODE          | 0             | -      | Selects lock detector mode<br>0: Counter restart mode<br>1: Up/Down counter mode<br><br>Recommended setting: LOCK_MODE=0.   |
| LOCK[1:0] | LOCK_ACCURACY[1:0] | 0             | -      | Selects lock accuracy (counter threshold values)<br>0: Declare lock at counter value 127, out of lock at value 111<br>1: Declare lock at counter value 255, out of lock at value 239<br>2: Declare lock at counter value 511, out of lock at value 495<br>3: Declare lock at counter value 1023, out of lock at value 1007  |

Note: Set LOCK\_SELECT=2 to use the LOCK pin as a lock indicator.

## FRONTEND Register (16h)

| REGISTER       | NAME                | Default value | Active | Description   |
|----------------|---------------------|---------------|--------|---|
| FRONTEND[7 :6] | LNAMIX_CURRENT[1:0] | 2             | -      | Controls current in LNA, LNA2 and mixer<br>Recommended setting: LNAMIX_CURRENT=1  |
| FRONTEND[5 :4] | LNA_CURRENT[1 :0]   | 1             | -      | Controls current in the LNA<br>Recommended setting: LNA_CURRENT=3.<br>Can be lowered to save power at the expense of reduced sensitivity.                                     |
| FRONTEND[3]    | MIX_CURRENT         | 0             | -      | Controls current in the mixer<br>Recommended setting:<br>MIX_CURRENT=1 at 426-464 MHz,<br>MIX_CURRENT=0 at 852-928 MHz.   |
| FRONTEND[2]    | LNA2_CURRENT        | 0             | -      | Controls current in LNA 2<br>Recommended settings:<br>LNA2_CURRENT=0 at 426-464 MHz,<br>LNA2_CURRENT=1 at 852-928 MHz.  |
| FRONTEND[1]    | SDC_CURRENT         | 0             | -      | Controls current in the single-to-diff. Converter<br>Recommended settings:<br>SDC_CURRENT=0 at 426-464 MHz,<br>SDC_CURRENT=1 at 852-928 MHz.                                  |
| FRONTEND[0]    | LNAMIX_BIAS         | 1             | -      | Controls how front-end bias currents are generated<br>0: Constant current biasing<br>1: Constant Gm·R biasing (reduces gain variation)<br>Recommended setting: LNAMIX_BIAS=0. |

## ANALOG Register (17h)

| REGISTER    | NAME                  | Default value | Active | Description  |
|-------------|-----------------------|---------------|--------|--|
| ANALOG[7]   | BANDSELECT            | 1             | -      | Frequency band selection<br>0: 402-470 MHz band<br>1: 804-960 MHz band   |
| ANALOG[6]   | LO_DC                 | 1             | -      | Lower LO DC level to mixers<br>0: High LO DC level to mixers<br>1: Low LO DC level to mixers<br><br>Recommended settings:<br>LO_DC=1 for 402-470 MHz,<br>LO_DC=0 for 804-960 MHz.  |
| ANALOG[5]   | VGA_BLANKING          | 1             | H      | Enable analog blanking switches in VGA when changing VGA gain.<br>0: Blanking switches are disabled<br>1: Blanking switches are turned on for approx. 0.8µs when gain is changed (always on if AGC_DISABLE=1)<br><br>Recommended setting: VGA_BLANKING=0.  |
| ANALOG[4]   | PD_LONG               | 0             | H      | Selects short or long reset delay in phase detector<br>0: Short reset delay<br>1: Long reset delay<br><br>Recommended setting: PD_LONG=0.  |
| ANALOG[3]   | -                     | 0             | -      | Reserved, write 0  |
| ANALOG[2]   | PA_BOOST              | 0             | H      | Boost PA bias current for higher output power<br><br>Recommended setting: PA_BOOST=1.  |
| ANALOG[1:0] | DIV_BUFF_CURRENT[1:0] | 3             | -      | Overall bias current adjustment for VCO divider and buffers<br>0: 4/6 of nominal VCO divider and buffer current<br>1: 4/5 of nominal VCO divider and buffer current<br>2: Nominal VCO divider and buffer current<br>3: 4/3 of nominal VCO divider and buffer current<br><br>Recommended setting:<br>DIV_BUFF_CURRENT=3 |

## BUFF\_SWING Register (18h)

| REGISTER        | NAME           | Default value | Active | Description  |
|-----------------|----------------|---------------|--------|--|
| BUFF_SWING[7:6] | PRE_SWING[1:0] | 3             | -      | Prescaler swing.<br>0: 2/3 of nominal swing<br>1: 1/2 of nominal swing<br>2: 4/3 of nominal swing<br>3: Nominal swing<br><br>Recommended setting: PRE_SWING=0.   |
| BUFF_SWING[5:3] | RX_SWING[2:0]  | 4             | -      | LO buffer swing, in RX (to mixers)<br>0: Smallest load resistance (smallest swing)<br>...<br>7: Largest load resistance (largest swing)<br><br>Recommended setting: RX_SWING=2.  |
| BUFF_SWING[2:0] | TX_SWING[2:0]  | 1             | -      | LO buffer swing, in TX (to power amplifier driver)<br>0: Smallest load resistance (smallest swing)<br>...<br>7: Largest load resistance (largest swing)<br><br>Recommended settings:<br>TX_SWING=4 for 402-470 MHz,<br>TX_SWING=0 for 804-960 MHz. |

## BUFF\_CURRENT Register (19h)

| REGISTER          | NAME             | Default value | Active | Description   |
|-------------------|------------------|---------------|--------|---|
| BUFF_CURRENT[7:6] | PRE_CURRENT[1:0] | 1             | -      | Prescaler current scaling<br>0: Nominal current<br>1: 2/3 of nominal current<br>2: 1/2 of nominal current<br>3: 2/5 of nominal current<br><br>Recommended setting: PRE_CURRENT=0.                       |
| BUFF_CURRENT[5:3] | RX_CURRENT[2:0]  | 4             | -      | LO buffer current, in RX (to mixers)<br>0: Minimum buffer current<br>...<br>7: Maximum buffer current<br><br>Recommended setting: RX_CURRENT=4.   |
| BUFF_CURRENT[2:0] | TX_CURRENT[2:0]  | 5             | -      | LO buffer current, in TX (to PA driver)<br>0: Minimum buffer current<br>...<br>7: Maximum buffer current<br><br>Recommended settings:<br>TX_CURRENT=2 for 402-470 MHz,<br>TX_CURRENT=5 for 804-960 MHz. |

## PLL\_BW Register (1Ah)

| REGISTER    | NAME        | Default value | Active | Description   |
|-------------|-------------|---------------|--------|---|
| PLL_BW[7:0] | PLL_BW[7:0] | 134           | -      | Charge pump current scaling/rounding factor. Used to calibrate charge pump current for the desired PLL loop bandwidth. The value is given by: $PLL\_BW = 174 + 16 \log_2(f_{ref}/7.126)$ where $f_{ref}$ is the reference frequency in MHz. |

## CALIBRATE Register (1Bh)

| REGISTER       | NAME             | Default value | Active | Description  |
|----------------|------------------|---------------|--------|--|
| CALIBRATE[7]   | CAL_START        | 0             | ↑      | ↑ 1: Calibration started<br>0: Calibration inactive  |
| CALIBRATE[6]   | CAL_DUAL         | 0             | H      | Use calibration results for both frequency A and B<br>0: Store results in A or B defined by F_REG (MAIN[6])<br>1: Store calibration results in both A and B  |
| CALIBRATE[5:4] | CAL_WAIT[1:0]    | 0             | -      | Selects calibration wait time (affects accuracy)<br>0 (00): Calibration time is approx. 90000 F_REF periods<br>1 (01): Calibration time is approx. 110000 F_REF periods<br>2 (10): Calibration time is approx. 130000 F_REF periods<br>3 (11): Calibration time is approx. 200000 F_REF periods<br><br>Recommended setting: CAL_WAIT=3 for best accuracy in calibrated PLL loop filter bandwidth.  |
| CALIBRATE[3]   | -                | 0             | -      | Reserved, write 0  |
| CALIBRATE[2:0] | CAL_ITERATE[2:0] | 5             | -      | Iteration start value for calibration DAC<br>0 (000): DAC start value 1, VC<0.49 V after calibration<br>1 (001): DAC start value 2, VC<0.66 V after calibration<br>2 (010): DAC start value 3, VC<0.82 V after calibration<br>3 (011): DAC start value 4, VC<0.99 V after calibration<br>4 (100): DAC start value 5, VC<1.15 V after calibration<br>5 (101): DAC start value 6, VC<1.32 V after calibration<br>6 (110): DAC start value 7, VC<1.48 V after calibration<br>7 (111): DAC start value 8, VC<1.65 V after calibration<br><br>Recommended setting: CAL_ITERATE=4. |



## PA\_POWER Register (1Ch)

| REGISTER      | NAME          | Default value | Active | Description  |
|---------------|---------------|---------------|--------|--|
| PA_POWER[7:4] | PA_HIGH [3:0] | 0             | -      | Controls output power in high-power array<br>0: High-power array is off<br>1: Minimum high-power array output power<br>...<br>15: Maximum high-power array output power  |
| PA_POWER[3:0] | PA_LOW[3:0]   | 15            | -      | Controls output power in low-power array<br>0: Low-power array is off<br>1: Minimum low-power array output power<br>...<br>15: Maximum low-power array output power<br><br>It is more efficient in terms of current consumption to use either the lower or upper 4-bits in the PA_POWER register to control the power. |

## MATCH Register (1Dh)

| REGISTER   | NAME          | Default value | Active | Description   |
|------------|---------------|---------------|--------|---|
| MATCH[7:4] | RX_MATCH[3:0] | 0             | -      | Selects matching capacitor array value for RX. Each step is approximately 0.4 pF. |
| MATCH[3:0] | TX_MATCH[3:0] | 0             | -      | Selects matching capacitor array value for TX. Each step is approximately 0.4 pF. |

## PHASE\_COMP Register (1Eh)

| REGISTER        | NAME            | Default value | Active | Description   |
|-----------------|-----------------|---------------|--------|---|
| PHASE_COMP[7:0] | PHASE_COMP[7:0] | 0             | -      | Signed compensation value for LO I/Q phase error. Used for image rejection calibration.<br>-128: approx. -6.2° adjustment between I and Q phase<br>-1: approx. -0.02° adjustment between I and Q phase<br>0: approx. +0.02° adjustment between I and Q phase<br>127: approx. +6.2° adjustment between I and Q phase |

## GAIN\_COMP Register (1Fh)

| REGISTER       | NAME           | Default value | Active | Description   |
|----------------|----------------|---------------|--------|---|
| GAIN_COMP[7:0] | GAIN_COMP[7:0] | 0             | -      | Signed compensation value for mixer I/Q gain error. Used for image rejection calibration.<br>-128: approx. -1.16 dB adjustment between I and Q gain<br>-1: approx. -0.004 dB adjustment between I and Q gain<br>0: approx. +0.004 dB adjustment between I and Q gain<br>127: approx. +1.16 dB adjustment between I and Q gain |

## POWERDOWN Register (20h)

| REGISTER     | NAME      | Default value | Active | Description   |
|--------------|-----------|---------------|--------|---|
| POWERDOWN[7] | PA_PD     | 0             | H      | Sets PA in power-down when $PD\_MODE[1:0]=2$                                    |
| POWERDOWN[6] | VCO_PD    | 0             | H      | Sets VCO in power-down when $PD\_MODE[1:0]=2$                                   |
| POWERDOWN[5] | BUFF_PD   | 0             | H      | Sets VCO divider, LO buffers and prescaler in power-down when $PD\_MODE[1:0]=2$ |
| POWERDOWN[4] | CHP_PD    | 0             | H      | Sets charge pump in power-down when $PD\_MODE[1:0]=2$                           |
| POWERDOWN[3] | LNAMIX_PD | 0             | H      | Sets LNA/mixer in power-down when $PD\_MODE[1:0]=2$                             |
| POWERDOWN[2] | VGA_PD    | 0             | H      | Sets VGA in power-down when $PD\_MODE[1:0]=2$                                   |
| POWERDOWN[1] | FILTER_PD | 0             | H      | Sets image filter in power-down when $PD\_MODE[1:0]=2$                          |
| POWERDOWN[0] | ADC_PD    | 0             | H      | Sets ADC in power-down when $PD\_MODE[1:0]=2$                                   |

## TEST1 Register (21h, for test only)

| REGISTER   | NAME              | Default value | Active | Description  |
|------------|-------------------|---------------|--------|--|
| TEST1[7:4] | CAL_DAC_OPEN[3:0] | 4             | -      | Calibration DAC override value, active when BREAK_LOOP=1 |
| TEST1[3:0] | CHP_CO[3:0]       | 13            | -      | Charge pump current override value                       |

## TEST2 Register (22h, for test only)

| REGISTER   | NAME         | Default value | Active | Description   |
|------------|--------------|---------------|--------|---|
| TEST2[7]   | BREAK_LOOP   | 0             | H      | 0: PLL loop closed<br>1: PLL loop open              |
| TEST2[6]   | CHP_OVERRIDE | 0             | H      | 0: use calibrated value<br>1: use CHP_CO[3:0] value |
| TEST2[5]   | VCO_OVERRIDE | 0             | H      | 0: use calibrated value<br>1: use VCO_AO[4:0] value |
| TEST2[4:0] | VCO_AO[4:0]  | 16            | -      | VCO_ARRAY override value                            |

## TEST3 Register (23h, for test only)

| REGISTER   | NAME             | Default value | Active | Description  |
|------------|------------------|---------------|--------|--|
| TEST3[7]   | VCO_CAL_MANUAL   | 0             | H      | Enables "manual" VCO calibration (test only)   |
| TEST3[6]   | VCO_CAL_OVERRIDE | 0             | H      | Override VCO current calibration<br>0: Use calibrated value<br>1: Use VCO_CO[5:0] value<br><br>VCO_CAL_OVERRIDE controls VCO_CAL_CLK if VCO_CAL_MANUAL=1. Negative transitions are then used to sample VCO_CAL_COMP. |
| TEST3[5:0] | VCO_CO[5:0]      | 6             | -      | VCO_CAL_CURRENT override value   |

## TEST4 Register (24h, for test only)

| REGISTER   | NAME        | Default value | Active | Description   |
|------------|-------------|---------------|--------|---|
| TEST4[7]   | CHP_DISABLE | 0             | H      | Disable normal charge pump operation  |
| TEST4[6]   | CHP_TEST_UP | 0             | H      | Force charge pump to output "up" current  |
| TEST4[5]   | CHP_TEST_DN | 0             | H      | Force charge pump to output "down" current  |
| TEST4[4:3] | TM_IQ[1:0]  | 0             | -      | Value of differential I and Q outputs from mixer when TM_ENABLE=1<br>0: I output negative, Q output negative<br>1: I output negative, Q output positive<br>2: I output positive, Q output negative<br>3: I output positive, Q output positive |
| TEST4[2]   | TM_ENABLE   | 0             | H      | Enable DC control of mixer output (for testing)   |
| TEST4[1]   | TF_ENABLE   | 0             | H      | Connect analog test module to filter inputs   |
| TEST4[0]   | TA_ENABLE   | 0             | H      | Connect analog test module to ADC inputs  |

If TF\_ENABLE=1 or TA\_ENABLE=1 in TEST4 register, then INTERFACE[3:0] controls analog test module: INTERFACE[3] = TEST\_PD, INTERFACE[2:0] = TEST\_MODE[2:0]. Otherwise, TEST\_PD=1 and TEST\_MODE[2]=1.

## TEST5 Register (25h, for test only)

| REGISTER   | NAME             | Default value | Active | Description  |
|------------|------------------|---------------|--------|--|
| TEST5[7]   | F_COMP_ENABLE    | 0             | H      | Enable frequency comparator output F_COMP from phase detector  |
| TEST5[6]   | SET_DITHER_CLOCK | 1             | H      | Enable dithering of delta-sigma clock  |
| TEST5[5]   | ADC_TEST_OUT     | 0             | H      | Outputs ADC samples on LOCK and DIO, while ADC_CLK is output on DCLK   |
| TEST5[4]   | CHOP_DISABLE     | 0             | H      | Disable chopping in ADC integrators  |
| TEST5[3]   | SHAPING_DISABLE  | 0             | H      | Disable ADC feedback mismatch shaping  |
| TEST5[2]   | VCM_ROT_DISABLE  | 0             | H      | Disable rotation for VCM mismatch shaping  |
| TEST5[1:0] | ADC_ROTATE[1:0]  | 0             | -      | Control ADC input rotation<br>0: Rotate in 00 01 10 11 sequence<br>1: Rotate in 00 10 11 01 sequence<br>2: Always use 00 position<br>3: Rotate in 00 10 00 10 sequence |

TEST6 Register (26h, for test only)

| REGISTER   | NAME         | Default value | Active | Description   |
|------------|--------------|---------------|--------|---|
| TEST6[7:4] | -            | 0             | -      | Reserved, write 0   |
| TEST6[3]   | VGA_OVERRIDE | 0             | -      | Override VGA settings   |
| TEST6[2]   | AC1O         | 0             | -      | Override value to first AC coupler in VGA<br>0: Approx. 0 dB gain<br>1: Approx. -12 dB gain   |
| TEST6[1:0] | AC2O[1:0]    | 0             | -      | Override value to second AC coupler in VGA<br>0: Approx. 0 dB gain<br>1: Approx. -3 dB gain<br>2: Approx. -12 dB gain<br>3: Approx. -15 dB gain |

TEST7 Register (27h, for test only)

| REGISTER   | NAME       | Default value | Active | Description                   |
|------------|------------|---------------|--------|-------------------------------|
| TEST7[7:6] | -          | 0             | -      | Reserved, write 0             |
| TEST7[5:4] | VGA1O[1:0] | 0             | -      | Override value to VGA stage 1 |
| TEST7[3:2] | VGA2O[1:0] | 0             | -      | Override value to VGA stage 2 |
| TEST7[1:0] | VGA3O[1:0] | 0             | -      | Override value to VGA stage 3 |

STATUS Register (40h, read only)

| REGISTER  | NAME            | Default value | Active | Description  |
|-----------|-----------------|---------------|--------|--|
| STATUS[7] | CAL_COMPLETE    | -             | H      | Set to 0 when PLL calibration starts, and set to 1 when calibration has finished |
| STATUS[6] | SEQ_ERROR       | -             | H      | Set to 1 when PLL failed to lock during automatic power-up sequencing            |
| STATUS[5] | LOCK_INSTANT    | -             | H      | Instantaneous PLL lock indicator   |
| STATUS[4] | LOCK_CONTINUOUS | -             | H      | PLL lock indicator, as defined by LOCK_ACCURACY. Set to 1 when PLL is in lock    |
| STATUS[3] | CARRIER_SENSE   | -             | H      | Carrier sense when RSSI is above CS_LEVEL  |
| STATUS[2] | LOCK            | -             | H      | Logical level on LOCK pin  |
| STATUS[1] | DCLK            | -             | H      | Logical level on DCLK pin  |
| STATUS[0] | DIO             | -             | H      | Logical level on DIO pin   |

RESET\_DONE Register (41h, read only)

| REGISTER      | NAME                | Default value | Active | Description   |
|---------------|---------------------|---------------|--------|---|
| RESET_DONE[7] | ADC_RESET_DONE      | -             | H      | Reset of ADC control logic done   |
| RESET_DONE[6] | AGC_RESET_DONE      | -             | H      | Reset of AGC (VGA control) logic done                                     |
| RESET_DONE[5] | GAUSS_RESET_DONE    | -             | H      | Reset of Gaussian data filter done  |
| RESET_DONE[4] | AFC_RESET_DONE      | -             | H      | Reset of AFC / FSK decision level logic done                              |
| RESET_DONE[3] | BITSYNC_RESET_DONE  | -             | H      | Reset of modulator, bit synchronization logic and PN9 PRBS generator done |
| RESET_DONE[2] | SYNTH_RESET_DONE    | -             | H      | Reset digital part of frequency synthesizer done                          |
| RESET_DONE[1] | SEQ_RESET_DONE      | -             | H      | Reset of power-up sequencing logic done                                   |
| RESET_DONE[0] | CAL_LOCK_RESET_DONE | -             | H      | Reset of calibration logic and lock detector done                         |

RSSI Register (42h, read only)

| REGISTER  | NAME      | Default value | Active | Description   |
|-----------|-----------|---------------|--------|---|
| RSSI[7]   | -         | -             | -      | Not in use, will read 0   |
| RSSI[6:0] | RSSI[6:0] | -             | -      | Received signal strength indicator.<br><br>The relative power is given by $RSSI \times 1.5$ dB in a logarithmic scale.<br><br>The VGA gain set by <i>VGA_SETTING</i> must be taken into account. See section 12.5 for more details. |

## AFC Register (43h, read only)

| REGISTER  | NAME     | Default value | Active | Description   |
|-----------|----------|---------------|--------|---|
| AFC[7 :0] | AFC[7:0] | -             | -      | Average received frequency deviation from IF. This 8-bit 2-complement signed value equals the demodulator decision level and can be used for AFC. The average frequency offset from the IF frequency is $\Delta F = \text{Baud rate} \cdot \text{AFC} / 16$ |

## GAUSS\_FILTER Register (44h)

| REGISTER           | NAME              | Default value | Active | Description   |
|--------------------|-------------------|---------------|--------|---|
| GAUSS_FILTER[7 :0] | GAUSS_FILTER[7:0] | -             | -      | Readout of instantaneous IF frequency offset from nominal IF. Signed 8-bit value.<br>$\Delta F = \text{Baud rate} \cdot \text{GAUSS\_FILTER} / 8$ |

## STATUS1 Register (45h, for test only)

| REGISTER     | NAME             | Default value | Active | Description  |
|--------------|------------------|---------------|--------|--|
| STATUS1[7:4] | CAL_DAC[3:0]     | -             | -      | Status vector defining applied Calibration DAC value |
| STATUS1[3:0] | CHP_CURRENT[3:0] | -             | -      | Status vector defining applied CHP_CURRENT value     |

## STATUS2 Register (46h, for test only)

| REGISTER      | NAME                 | Default value | Active | Description  |
|---------------|----------------------|---------------|--------|--|
| STATUS2[7 :5] | CC1020_VERSION[2 :0] | -             | -      | CC1020 version code :<br>0 : Pre-production version<br>1: First production version<br>2-7: Reserved for future use |
| STATUS2[4:0]  | VCO_ARRAY[4:0]       | -             | -      | Status vector defining applied VCO_ARRAY value   |

## STATUS3 Register (47h, for test only)

| REGISTER     | NAME                 | Default value | Active | Description  |
|--------------|----------------------|---------------|--------|--|
| STATUS3[7]   | F_COMP               | -             | -      | Frequency comparator output from phase detector  |
| STATUS3[6]   | VCO_CAL_COMP         | -             | -      | Readout of VCO current calibration comparator.<br><br>Equals 1 if current defined by VCO_CURRENT_A/B is larger than the VCO core current |
| STATUS3[5:0] | VCO_CAL_CURRENT[5:0] | -             | -      | Status vector defining applied VCO_CAL_CURRENT value   |

## STATUS4 Register (48h, for test only)

| REGISTER     | NAME         | Default value | Active | Description                   |
|--------------|--------------|---------------|--------|-------------------------------|
| STATUS4[7:6] | ADC_MIX[1:0] | -             | -      | Readout of mixer input to ADC |
| STATUS4[5:3] | ADC_I[2:0]   | -             | -      | Readout of ADC "I" output     |
| STATUS4[2:0] | ADC_Q[2:0]   | -             | -      | Readout of ADC "Q" output     |

## STATUS5 Register (49h, for test only)

| REGISTER     | NAME          | Default value | Active | Description                                  |
|--------------|---------------|---------------|--------|--|
| STATUS5[7:0] | FILTER_I[7:0] | -             | -      | Upper bits of "I" output from channel filter |

## STATUS6 Register (4Ah, for test only)

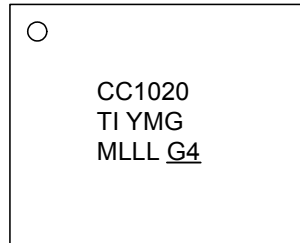
| REGISTER      | NAME           | Default value | Active | Description                                  |
|---------------|----------------|---------------|--------|--|
| STATUS6[7 :0] | FILTER_Q[7 :0] | -             | -      | Upper bits of "Q" output from channel filter |

## STATUS7 Register (4Bh, for test only)

| REGISTER     | NAME                 | Default value | Active | Description  |
|--------------|----------------------|---------------|--------|--|
| STATUS7[7:5] | -                    | -             | -      | Not in use, will read 0  |
| STATUS7[4:0] | VGA_GAIN_OFFSET[4:0] | -             | -      | Readout of offset between VGA_SETTING and actual VGA gain set by AGC |

**27. Package Marking**

When contacting technical support with a chip-related question, please state the entire marking information as shown below.



- o – pin one symbolization
- TI – TI letters
- YM – Year Month Date Code
- GMLLL – Assy Lot Code
- G4 – fixed code

**28. Soldering Information**

The recommendations for lead-free reflow in IPC/JEDEC J-STD-020 should be followed.

**29. Plastic Tube Specification**

Description: MAGAZINE, 7X7 QFN

| Tube Specification |         |            |             |                |
|--------------------|---------|------------|-------------|----------------|
| Device             | Package | Tube Width | Tube Length | Units per Tube |
| CC1020RUZ          | QFN 32  | 8.91 mm    | 381 mm      | 52             |

## 30. Ordering Information

| Orderable Device | Status (1) | Package Type | Package Drawing | Pins | Package Qty | Eco Plan (2)            | Lead Finish | MSL Peak Temp (3)     |
|------------------|------------|--------------|-----------------|------|-------------|-------------------------|-------------|-----------------------|
| CC1020RUZ        | Active     | QFN          | RUZ             | 32   | 2080        | Green (RoHS & no Sb/Br) | Cu NiPdAu   | LEVEL3-260C<br>1 YEAR |
| CC1020RUZR       | Active     | QFN          | RUZ             | 32   | 2500        | Green (RoHS & no Sb/Br) | Cu NiPdAu   | LEVEL3-260C<br>1 YEAR |

| Orderable Evaluation Module | Description                              | Minimum Order Quantity |
|-----------------------------|--|------------------------|
| CC1020_1070DK-433           | CC1020/1070 Development Kit, 433 MHz     | 1                      |
| CC1020_1070DK-868/915       | CC1020/1070 Development Kit, 868/915 MHz | 1                      |

(1) The marketing status values are defined as follows:

**ACTIVE:** Product device recommended for new designs.

**LIFEBUY:** TI has announced that the device will be discontinued, and a lifetime-buy period is in effect.

**NRND:** Not recommended for new designs. Device is in production to support existing customers, but TI does not recommend using this part in a new design.

**PREVIEW:** Device has been announced but is not in production. Samples may or may not be available.

**OBSOLETE:** TI has discontinued the production of the device.

(2) Eco Plan - The planned eco-friendly classification: Pb-Free (RoHS), Pb-Free (RoHS Exempt), or Green (RoHS & no Sb/Br) - please check <http://www.ti.com/productcontent> for the latest availability information and additional product content details.

**TBD:** The Pb-Free/Green conversion plan has not been defined.

**Pb-Free (RoHS):** TI's terms "Lead-Free" or "Pb-Free" mean semiconductor products that are compatible with the current RoHS requirements for all 6 substances, including the requirement that lead not exceed 0.1% by weight in homogeneous materials. Where designed to be soldered at high temperatures, TI Pb-Free products are suitable for use in specified lead-free processes.

**Pb-Free (RoHS Exempt):** This component has a RoHS exemption for either 1) lead-based flip-chip solder bumps used between the die and package, or 2) lead-based die adhesive used between the die and leadframe. The component is otherwise considered Pb-Free (RoHS compatible) as defined above.

**Green (RoHS & no Sb/Br):** TI defines "Green" to mean Pb-Free (RoHS compatible), and free of Bromine (Br) and Antimony (Sb) based flame retardants (Br or Sb do not exceed 0.1% by weight in homogeneous material)

(3) MSL, Peak Temp. -- The Moisture Sensitivity Level rating according to the JEDEC industry standard classifications, and peak solder temperature.

**Important Information and Disclaimer:** The information provided on this page represents TI's knowledge and belief as of the date that it is provided. TI bases its knowledge and belief on information provided by third parties, and makes no representation or warranty as to the accuracy of such information. Efforts are underway to better integrate information from third parties. TI has taken and continues to take reasonable steps to provide representative and accurate information but may not have conducted destructive testing or chemical analysis on incoming materials and chemicals. TI and TI suppliers consider certain information to be proprietary, and thus CAS numbers and other limited information may not be available for release.

In no event shall TI's liability arising out of such information exceed the total purchase price of the TI part(s) at issue in this document sold by TI to Customer on an annual basis.

31. General Information

Document Revision History

| Revision | Date          | Description/Changes  |
|----------|---------------|--|
| 1.4      | November 2003 | New improved image calibration routine.<br>Changes to preamble length and synchronization word for improved packet error rate.<br>Included plot of blocking/selectivity.<br>Included data on PA_EN and LNA_EN pin drive.<br>Changes to Digital FM.<br>Changes to some of the electrical specification parameters.  |
| 1.5      | February 2004 | Included data for intermodulation rejection<br>Changed "channel width" to "channel spacing"<br>Maximum power down current increased from 1 uA to 1.8 uA.<br>Update on preamble length and synchronization word for improved packet error rate.   |
| 1.6      | December 2004 | The various sections have been reorganized to improve readability<br>Added chapter numbering<br>Reorganized electrical specification section<br>Electrical specifications updated<br>Changes to sensitivity figures<br>Changes to TX spurious emission and harmonics figures<br>Changes to ACP figure at 868 MHz operation<br>Changes to current consumption figures in RX and TX mode and crystal oscillator, bias and synthesizer mode<br>Changes to noise figure<br>Updates to section on input / output matching<br>Updates to section on VCO and PLL self-calibration<br>Updates to section on VCO, charge pump and PLL loop filter<br>Updates to section on receiver channel filter bandwidth<br>Updates to section on RSSI<br>Updates to section on image rejection calibration<br>Updates to section on preamble length and sync word<br>Description of OOK modulation and demodulation merged into one section<br>New bill of materials for operation at 433 MHz and 868/915 MHz<br>Added recommended PCB footprint for package (QFN 32)<br>Added information that there should be no via at "pin #1 corner" (section 27.1)<br>Added list of abbreviations<br>Changes to ordering information |
| 1.7      | October 2005  | RSSI dynamic range changed from 63 dB to 55 dB<br>Recommended CAL_ITERATE changed from 5 to 4<br>PLL timeout in "Automatic power-up sequencing flow chart" changed from 1024 filter clocks to 127 filter clocks<br>Calibration routine flow chart changed in accordance to CC1020 Errata Note 004<br>Added chapter on TX data latency  |
| 1.8      | January 2006  | Updates to Ordering Information and Address Information  |
| SWRS046A | November 2007 | Main reason for update was that some of the symbols in the data sheet were garbled.<br>The drill diameter for the vias underneath the die attached pad changed from 14 mil to 10 mil.<br>The spurious reception parameter changed from Max 40 dB to Min 40 dB.   |
| SWRS046B | July 2008     | Updated Plastic Tube specification, Carrier Tape and Reel specification to reflect new MOQ quantities.   |
| SWRS046C | February 2009 | Package Description changed to reflect CC1020RUZ in compliance with PCN20081216001.<br>Package Marking changed in compliance with PCN20081216001.<br>Package Thermal Properties removed to align with general TI datasheets<br>Plastic Tube Specification: added device CC1020RUZ and changed tube width to reflect CC1020RUZ in compliance with PCN20081216001.<br>Carrier Tape and Reel Specification: added device CC1020RUZR<br>Ordering Information: changed device orderable names to CC1020RUZ and CC1020RUZR in compliance with PCN20081216001.<br>Added important information and disclaimer<br>Product Status Definition: removed<br>Carrier Tape and Reel Specification is removed, since this was duplicate information to Tape And Reel Information   |



| Revision | Date           | Description/Changes   |
|----------|----------------|---|
| SWRS046D | September 2009 | Added reference to Application Note AN070 <i>CC1020 Automatic Power-Up Sequencing</i> .<br>Interchanged XOSC_Q1 and XOSC_Q2 in figure 33 to reflect the reference design.<br>Increased maximum RF frequency from 940 MHz to 960 MHz.<br>Added reference to ARIB STD-T96.<br>Updated Package Marking in Section 27.1 |
| SWRS046E | January 2010   | Chapter on Package Drawing and chapter on Recommended PCB Footprint for Package removed from data sheet since this was duplicate information  |

## TAPE AND REEL INFORMATION



### QUADRANT ASSIGNMENTS FOR PIN 1 ORIENTATION IN TAPE



\*All dimensions are nominal

| Device     | Package Type | Package Drawing | Pins | SPQ  | Reel Diameter (mm) | Reel Width W1 (mm) | A0 (mm) | B0 (mm) | K0 (mm) | P1 (mm) | W (mm) | Pin1 Quadrant |
|------------|--------------|-----------------|------|------|--------------------|--------------------|---------|---------|---------|---------|--------|---------------|
| CC1020RUZR | VQFN         | RUZ             | 32   | 2500 | 330.0              | 16.4               | 7.3     | 7.3     | 1.5     | 12.0    | 16.0   | Q2            |

**TAPE AND REEL BOX DIMENSIONS**



\*All dimensions are nominal

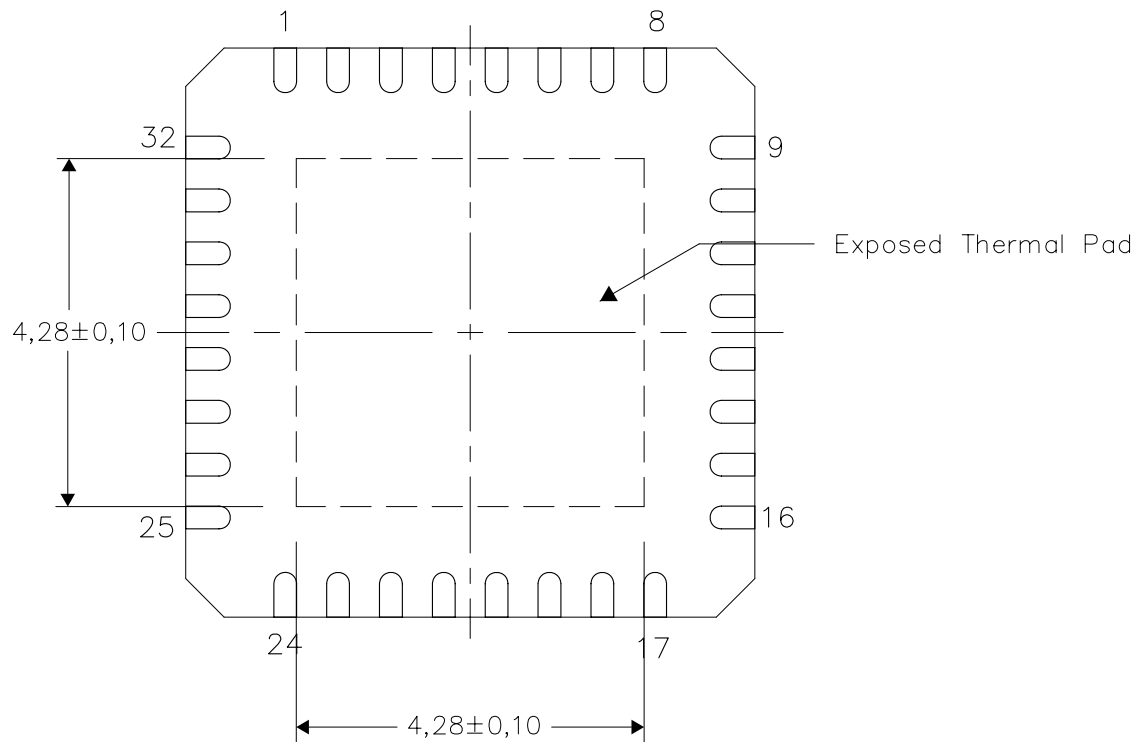
| Device     | Package Type | Package Drawing | Pins | SPQ  | Length (mm) | Width (mm) | Height (mm) |
|------------|--------------|-----------------|------|------|-------------|------------|-------------|
| CC1020RUZR | VQFN         | RUZ             | 32   | 2500 | 333.2       | 345.9      | 28.6        |

**THERMAL INFORMATION**

This package incorporates an exposed thermal pad that is designed to be attached directly to an external heatsink. The thermal pad must be soldered directly to the printed circuit board (PCB). After soldering, the PCB can be used as a heatsink. In addition, through the use of thermal vias, the thermal pad can be attached directly to the appropriate copper plane shown in the electrical schematic for the device, or alternatively, can be attached to a special heatsink structure designed into the PCB. This design optimizes the heat transfer from the integrated circuit (IC).

For information on the Quad Flatpack No-Lead (QFN) package and its advantages, refer to Application Report, QFN/SON PCB Attachment, Texas Instruments Literature No. SLUA271. This document is available at [www.ti.com](http://www.ti.com).

The exposed thermal pad dimensions for this package are shown in the following illustration.



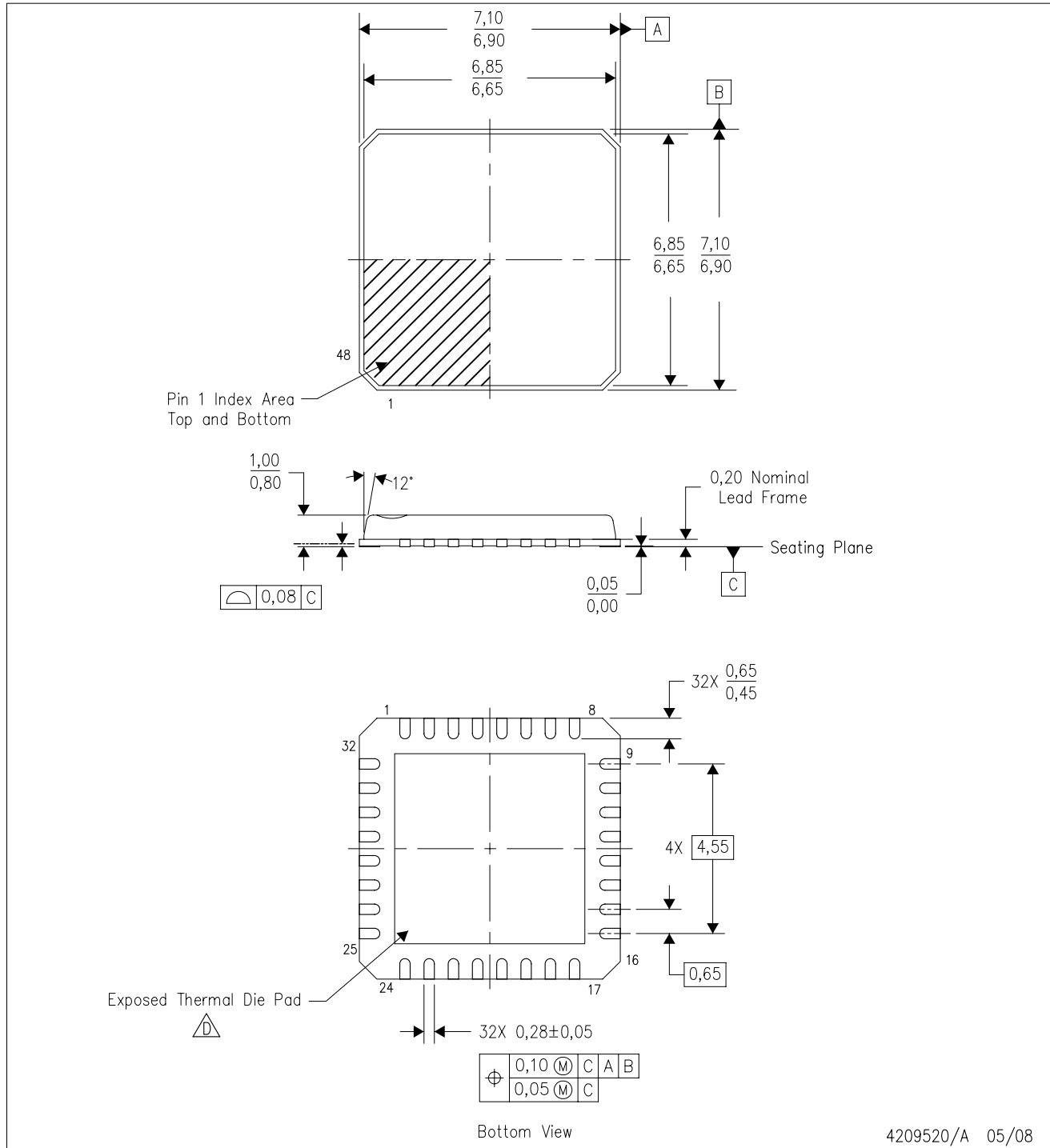
Bottom View

NOTE: All linear dimensions are in millimeters

Exposed Thermal Pad Dimensions

RUZ (S-PVQFN-N32)

PLASTIC QUAD FLATPACK NO-LEAD



4209520/A 05/08

- NOTES:
- A. All linear dimensions are in millimeters. Dimensioning and tolerancing per ASME Y14.5M-1994.
  - B. This drawing is subject to change without notice.
  - C. QFN (Quad Flatpack No-Lead) Package configuration.
  - △ The package thermal pad must be soldered to the board for thermal and mechanical performance. See the Product Data Sheet for details regarding the exposed thermal pad dimensions.
  - E. Package complies to JEDEC MO-220.

## TAPE AND REEL INFORMATION



### QUADRANT ASSIGNMENTS FOR PIN 1 ORIENTATION IN TAPE



\*All dimensions are nominal

| Device     | Package Type | Package Drawing | Pins | SPQ  | Reel Diameter (mm) | Reel Width W1 (mm) | A0 (mm) | B0 (mm) | K0 (mm) | P1 (mm) | W (mm) | Pin1 Quadrant |
|------------|--------------|-----------------|------|------|--------------------|--------------------|---------|---------|---------|---------|--------|---------------|
| CC1020RUZR | VQFN         | RUZ             | 32   | 2500 | 330.0              | 16.4               | 7.3     | 7.3     | 1.5     | 12.0    | 16.0   | Q2            |

**TAPE AND REEL BOX DIMENSIONS**


\*All dimensions are nominal

| Device     | Package Type | Package Drawing | Pins | SPQ  | Length (mm) | Width (mm) | Height (mm) |
|------------|--------------|-----------------|------|------|-------------|------------|-------------|
| CC1020RUZR | VQFN         | RUZ             | 32   | 2500 | 333.2       | 345.9      | 28.6        |

## IMPORTANT NOTICE

Texas Instruments Incorporated and its subsidiaries (TI) reserve the right to make corrections, modifications, enhancements, improvements, and other changes to its products and services at any time and to discontinue any product or service without notice. Customers should obtain the latest relevant information before placing orders and should verify that such information is current and complete. All products are sold subject to TI's terms and conditions of sale supplied at the time of order acknowledgment.

TI warrants performance of its hardware products to the specifications applicable at the time of sale in accordance with TI's standard warranty. Testing and other quality control techniques are used to the extent TI deems necessary to support this warranty. Except where mandated by government requirements, testing of all parameters of each product is not necessarily performed.

TI assumes no liability for applications assistance or customer product design. Customers are responsible for their products and applications using TI components. To minimize the risks associated with customer products and applications, customers should provide adequate design and operating safeguards.

TI does not warrant or represent that any license, either express or implied, is granted under any TI patent right, copyright, mask work right, or other TI intellectual property right relating to any combination, machine, or process in which TI products or services are used. Information published by TI regarding third-party products or services does not constitute a license from TI to use such products or services or a warranty or endorsement thereof. Use of such information may require a license from a third party under the patents or other intellectual property of the third party, or a license from TI under the patents or other intellectual property of TI.

Reproduction of TI information in TI data books or data sheets is permissible only if reproduction is without alteration and is accompanied by all associated warranties, conditions, limitations, and notices. Reproduction of this information with alteration is an unfair and deceptive business practice. TI is not responsible or liable for such altered documentation. Information of third parties may be subject to additional restrictions.

Resale of TI products or services with statements different from or beyond the parameters stated by TI for that product or service voids all express and any implied warranties for the associated TI product or service and is an unfair and deceptive business practice. TI is not responsible or liable for any such statements.

TI products are not authorized for use in safety-critical applications (such as life support) where a failure of the TI product would reasonably be expected to cause severe personal injury or death, unless officers of the parties have executed an agreement specifically governing such use. Buyers represent that they have all necessary expertise in the safety and regulatory ramifications of their applications, and acknowledge and agree that they are solely responsible for all legal, regulatory and safety-related requirements concerning their products and any use of TI products in such safety-critical applications, notwithstanding any applications-related information or support that may be provided by TI. Further, Buyers must fully indemnify TI and its representatives against any damages arising out of the use of TI products in such safety-critical applications.

TI products are neither designed nor intended for use in military/aerospace applications or environments unless the TI products are specifically designated by TI as military-grade or "enhanced plastic." Only products designated by TI as military-grade meet military specifications. Buyers acknowledge and agree that any such use of TI products which TI has not designated as military-grade is solely at the Buyer's risk, and that they are solely responsible for compliance with all legal and regulatory requirements in connection with such use.

TI products are neither designed nor intended for use in automotive applications or environments unless the specific TI products are designated by TI as compliant with ISO/TS 16949 requirements. Buyers acknowledge and agree that, if they use any non-designated products in automotive applications, TI will not be responsible for any failure to meet such requirements.

Following are URLs where you can obtain information on other Texas Instruments products and application solutions:

| <b>Products</b>             |  | <b>Applications</b>        |  |
|-----------------------------|--|----------------------------|--|
| Amplifiers                  | <a href="http://amplifier.ti.com">amplifier.ti.com</a>             | Audio                      | <a href="http://www.ti.com/audio">www.ti.com/audio</a>                                   |
| Data Converters             | <a href="http://dataconverter.ti.com">dataconverter.ti.com</a>     | Automotive                 | <a href="http://www.ti.com/automotive">www.ti.com/automotive</a>                         |
| DLP® Products               | <a href="http://www.dlp.com">www.dlp.com</a>                       | Communications and Telecom | <a href="http://www.ti.com/communications">www.ti.com/communications</a>                 |
| DSP                         | <a href="http://dsp.ti.com">dsp.ti.com</a>                         | Computers and Peripherals  | <a href="http://www.ti.com/computers">www.ti.com/computers</a>                           |
| Clocks and Timers           | <a href="http://www.ti.com/clocks">www.ti.com/clocks</a>           | Consumer Electronics       | <a href="http://www.ti.com/consumer-apps">www.ti.com/consumer-apps</a>                   |
| Interface                   | <a href="http://interface.ti.com">interface.ti.com</a>             | Energy                     | <a href="http://www.ti.com/energy">www.ti.com/energy</a>                                 |
| Logic                       | <a href="http://logic.ti.com">logic.ti.com</a>                     | Industrial                 | <a href="http://www.ti.com/industrial">www.ti.com/industrial</a>                         |
| Power Mgmt                  | <a href="http://power.ti.com">power.ti.com</a>                     | Medical                    | <a href="http://www.ti.com/medical">www.ti.com/medical</a>                               |
| Microcontrollers            | <a href="http://microcontroller.ti.com">microcontroller.ti.com</a> | Security                   | <a href="http://www.ti.com/security">www.ti.com/security</a>                             |
| RFID                        | <a href="http://www.ti-rfid.com">www.ti-rfid.com</a>               | Space, Avionics & Defense  | <a href="http://www.ti.com/space-avionics-defense">www.ti.com/space-avionics-defense</a> |
| RF/IF and ZigBee® Solutions | <a href="http://www.ti.com/lprf">www.ti.com/lprf</a>               | Video and Imaging          | <a href="http://www.ti.com/video">www.ti.com/video</a>                                   |
|                             |  | Wireless                   | <a href="http://www.ti.com/wireless-apps">www.ti.com/wireless-apps</a>                   |

Mailing Address: Texas Instruments, Post Office Box 655303, Dallas, Texas 75265  
Copyright © 2010, Texas Instruments Incorporated