

OA172 Series

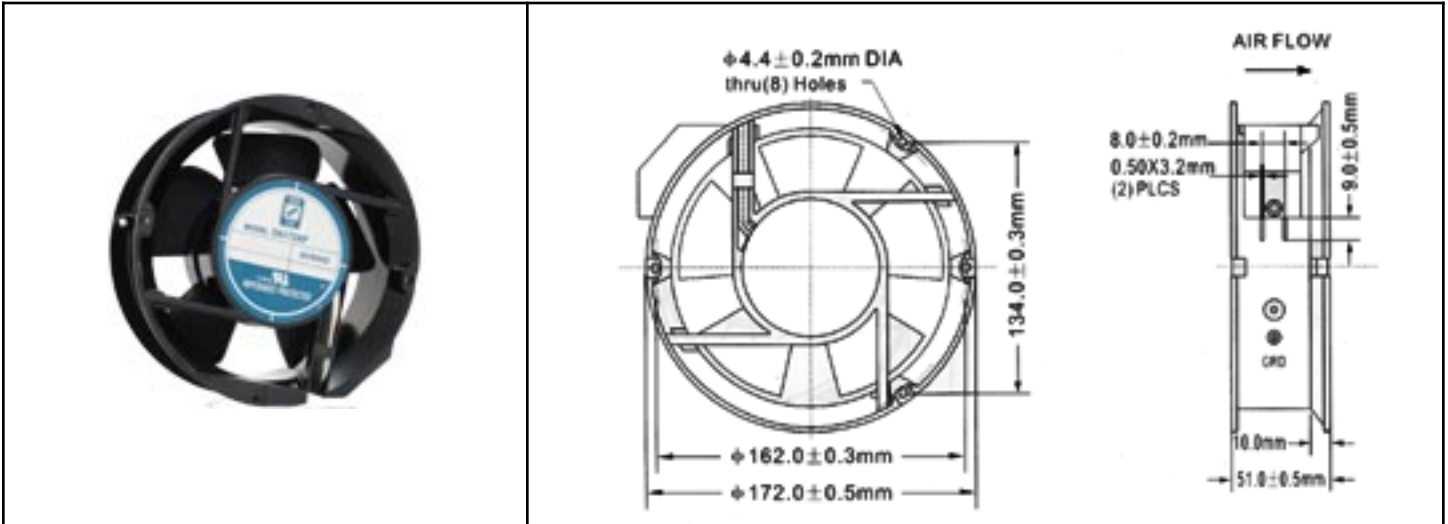

172 x 51mm
(6.7"x 2.0")



Frame	Diecast Aluminum	<u>Operating Temperature</u> Ball Bearing -40C ~ +70C <u>Life Expectancy</u> Ball Bearing 60,000 hours (L10 at 40C)	
Impeller	PBT, UL94V-O plastic		
Connection	2x Lead Wires or Terminals		
Motor	Capacitor drive, impedance and thermally protected		
Bearing System	Dual ball		
Insulation Resistance	>100M ohm between lead-wire and frame (500VDC)		
Dielectric Strength	1 min at 1500 VAC, 50/60Hz		

Model Number	Speed (RPM)	Airflow (CFM)	Noise (dB)	Volts AC	Voltage Range	Watts	Max. Static Pressure (\"H2O)
OA172AP-11-1()B	3500	235	46	115	80~130	35	0.70
OA172AP-11-2()B	2400	170	35	115	80~130	20	0.55
OA172AP-11-3()B	1500	106	27	115	80~130	16	0.31
OA172AP-22-1()B	3500	235	46	230	160~260	35	0.70
OA172AP-22-2()B	2400	170	35	230	160~260	20	0.55
OA172AP-22-3()B	1500	106	27	230	160~260	16	0.31

() Indicate "T" for Terminal or "W" for Wire Leads