

Girder and Flange Fixings — continued

Pipe Hanger
Galvanised Steel

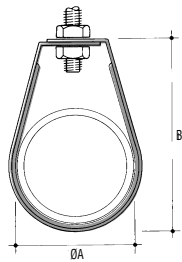
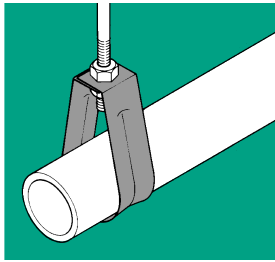

- Used in conjunction with threaded rod
- Supports pipes up to 150mm in diameter

FOR THREADED ROD, SEE PAGE 697

H357

ØA	B	Mftrs. List No.	Order Code	1+	25+	100+	250+	500+
20	64	PH-20	327-1950					
25	72	PH-25	327-1961					
32	83	PH-32	327-1973					
40	96	PH-40	327-1985					
50	113	PH-50	327-1997					
65	132	PH-65	327-2000					
80	156	PH-80	327-2011					
100	215	PH-100	327-2023	1+	10+	50+	100+	250+
125	242	PH-125	327-2035					
150	279	PH-150	327-2047					

Threaded Rod Hanger, 'Z' Purlin
Mechanically Galvanised and Passivated

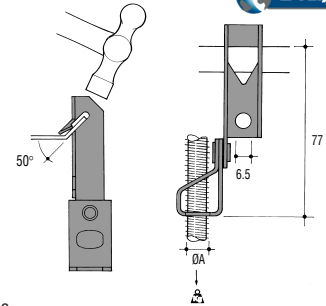
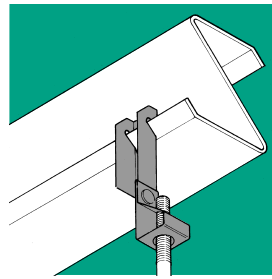

- Designed specifically for 'Z' Purlins
- Suitable for internal/external use, humid and mildly corrosive environments
- Ideal for supporting pipes, conduit, light fittings, etc.

Max. Loading 45kg

H360

ØA	Mftrs. List No.	Order Code	1+	25+	100+	250+	500+
M6	VM03-AM6T	327-5012					
M8	VM03-AM8T	327-5024					
M10	VM03-AM10T	327-5036					

Pipe Support Clips
Zinc Plated

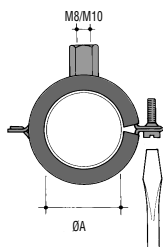
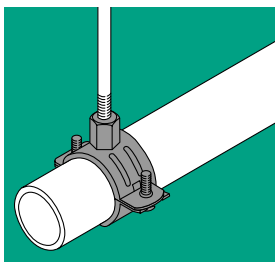

- Double threaded boss M8/M10
- EDPM rubber lining

Operating temperature -40°C to +110°C

H358

Ø	Mftrs. List No.	Order Code	1+	10+	50+	100+	150+
14-15	PCH-1415	327-4871					
16-18	PCH-1618	327-4883					
20-22	PCH-2022	327-4895					
25-28	PCH-2528	327-4901					
33-35	PCH-3335	327-4913					
42-44	PCH-4244	327-4925					
48-50	PCH-4850	327-4937					
52-54	PCH-5254	327-4949					
60-64	PCH-6064	327-4950					

Rod Hanger, Light Duty
Mechanically Galvanised and Passivated

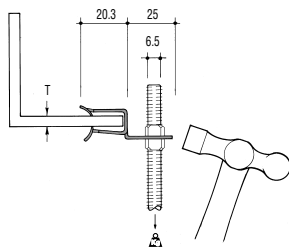
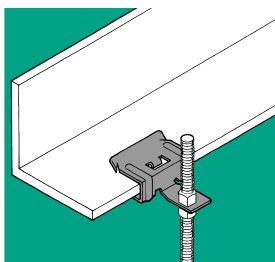

- Suitable for internal/external use, humid and mildly corrosive environments

Max. Loading 20kg

H359

T	Mftrs. List No.	Order Code	25+	100+	250+	500+
3-8	AHB-38	327-4962				

Cable Tie Fixing
Mechanically Galvanised and Passivated

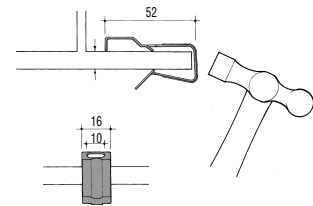
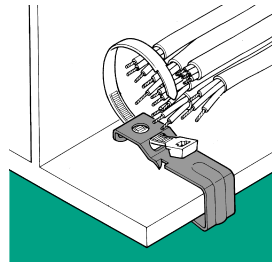

- Horizontal/vertical cable tie fixing
- Can be used with standard cable ties
- Helps secure cables, pipework, etc.

H361

Order Multiple=25	T	Mftrs. List No.	Order Code	25+	100+	250+	500+
3-10		GH-310	327-6624				
10-18		GH-1018	327-6636				

Cable Tie Clips
Mechanically Galvanised and Passivated

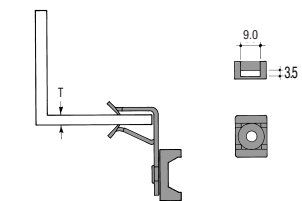
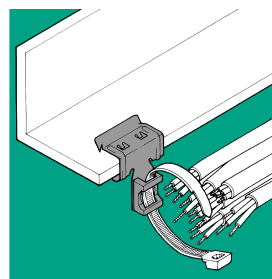

Horizontal

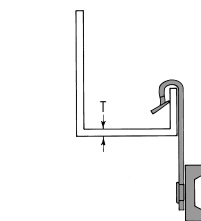
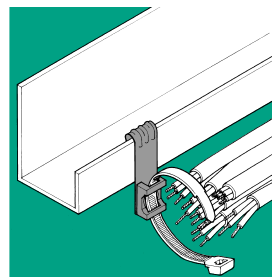

Vertical

- Horizontal and vertical versions
- Plastic clip steel fixing
- Suitable for internal/external use, humid and mildly corrosive environments

H362